



Your technology partner for cost-effective machining

# OptiMill<sup>®</sup>-HPC-Pocket

# OptiMill®-HPC-Pocket

## Maximum efficiency in pocket milling

The OptiMill-Uni-HPC-Pocket and OptiMill-Alu-HPC-Pocket milling tools stand for maximum precision and efficiency in pocket milling. Both tools are equipped with an integrated drill point, which is particularly suitable for versatile applications such as helical milling, grooving and inclined plunging. Large chip spaces on both milling cutters ensure fast and reliable chip evacuation, even with high cutting volumes, while a special cutting edge preparation and wear-resistant coating guarantee a long tool life and maximum process reliability.

The innovative geometry of the milling cutters prevents chip build-up and enables smooth machining, resulting in outstanding surface quality. Thanks to these advanced technical features, the OptiMill-Uni-HPC-Pocket and the OptiMill-Alu-HPC-Pocket are ideal tools for the efficient and precise machining of steel, cast iron and aluminium.

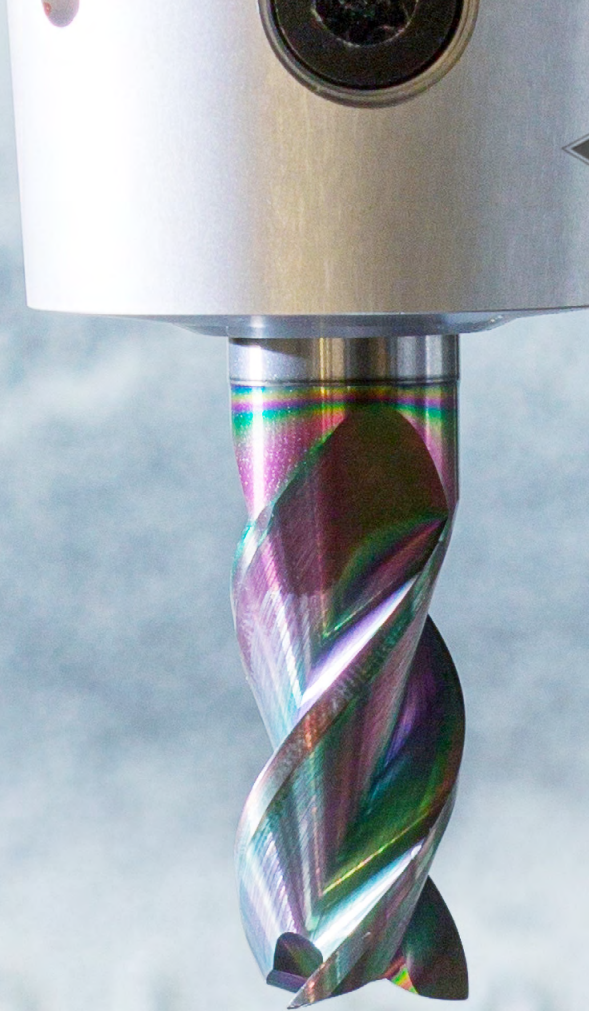

### ✓ INNOVATIVE SHARPENING

### ✓ BROAD FIELD OF APPLICATION



**Grooving (drilling)  
and ramps with  
very high feed rates**

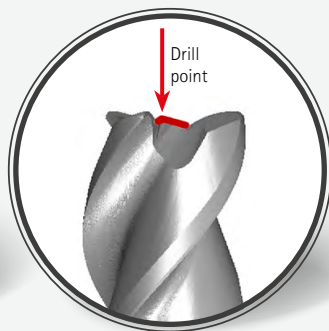

**Integrated  
drill point especially  
for plunge milling**

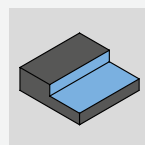

Shoulder milling

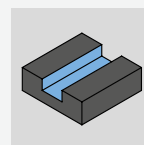

Groove milling

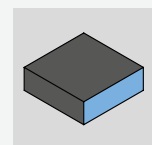

Trimming

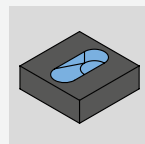

Ramps

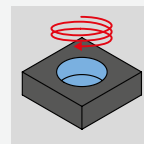

Helix milling

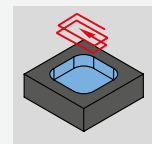

Pocket milling



<b>P</b>	Steel
<b>M</b>	Stainless steel
<b>K</b>	Cast iron
<b>N</b>	Aluminum

### PROCESSING TIME [SEC.]

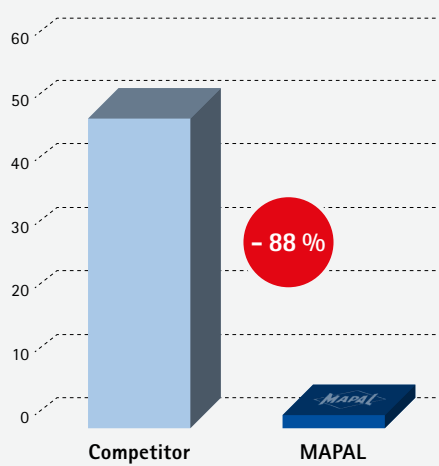

**RESULT: 88 % faster processing time.**

### TOOL LIFE [SEC.]

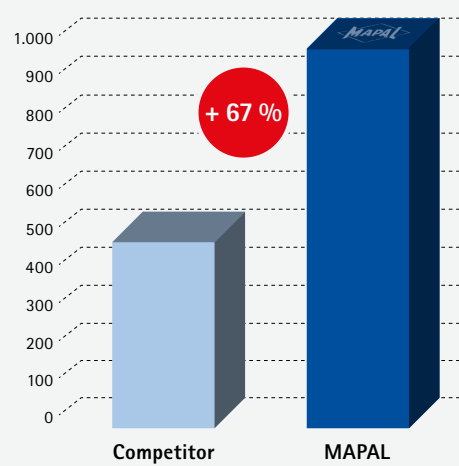

**RESULT: 67 % longer tool life.**

# OptiMill®-Uni-HPC-Pocket

## Efficient pocket milling

The OptiMill-Uni-HPC-Pocket corner milling cutter with integrated drill point was specially developed for pocket milling steel and cast iron. The specially developed pointing, together with three large chip spaces, guarantees optimum chip evacuation. The special core rise ensures optimum stability in the machining process, making the tool ideal for helical milling and grooving.

### 1 Integrated drill point

- Suitable for inclined plunging up to 45°, for helical milling and grooving

### 2 Large chip spaces

- Fast and reliable chip removal with large chip volumes

### 3 Special cutting edge preparation and wear-resistant coating

- Long tool life and maximum process safety

### 4 Innovative pointing

- Grooving (drilling) & ramping with very high feed rates

### 5 Three chip breakers per cutting edge with dimension 3xD

- Short chips for maximum process reliability



## Features

### Preferred series in stock:

- Design z=3: short, long, extra-long
- Design z=4: 3xD with neck
- $\phi$ -range: 3,80 - 20,00 mm
- Shank form: HB

### Configurable features:

- $\phi$ -range: 3,80 - 20,00 mm
- Shank form: HA

## OptiMill-Uni-HPC-Pocket



Short design, z=3

Long design with neck, z=3

Overlong design with neck, z=3

Maximum performance for peripheral milling.  
3xD design, z=4

# OptiMill®-Uni-HPC-Pocket

Shoulder milling cutter, short design  
SCM840

## Design:

Diameter of milling cutter: 3.80 – 20.00 mm  
Cutting material: HP920  
Number of cutting edges: 3  
Helix angle: ~ 42°  
Special features: Face geometry with integrated drill tip

## Application:

Perfect for inclined plunging up to 45°,  
in helix milling and grooving.

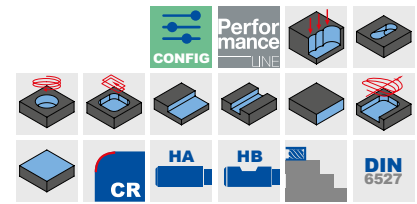
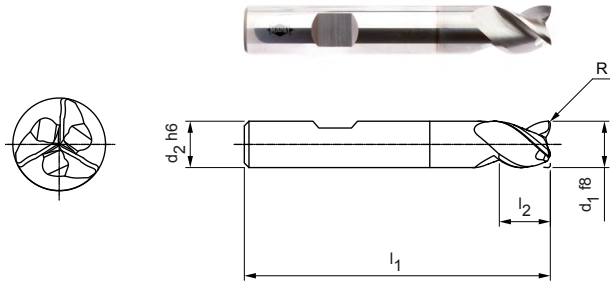

## Preferred series in stock

Dimensions						z	Specification	Order no.
d <sub>1</sub> f8	d <sub>2</sub> h6	l <sub>1</sub>	l <sub>2</sub>	l <sub>5</sub>	R*			
3,80	6	54	5	10,5	0,12	3	SCM840-0380Z03R-R0012HB-HP920	31031129
4,00	6	54	5	10,5	0,12	3	SCM840-0400Z03R-R0012HB-HP920	31031140
4,80	6	54	6	12,5	0,2	3	SCM840-0480Z03R-R0020HB-HP920	31031141
5,00	6	54	6	12,5	0,2	3	SCM840-0500Z03R-R0020HB-HP920	31031142
5,70	6	54	7	14,5	0,2	3	SCM840-0570Z03R-R0020HB-HP920	30965832
6,00	6	54	7	-	0,2	3	SCM840-0600Z03R-R0020HB-HP920	30965833
6,70	8	58	8	16,5	0,2	3	SCM840-0670Z03R-R0020HB-HP920	30965834
7,00	8	58	8	17	0,2	3	SCM840-0700Z03R-R0020HB-HP920	30965835
7,70	8	58	9	18,5	0,2	3	SCM840-0770Z03R-R0020HB-HP920	30965836
8,00	8	58	9	-	0,2	3	SCM840-0800Z03R-R0020HB-HP920	30965837
8,70	10	66	10	20,5	0,32	3	SCM840-0870Z03R-R0032HB-HP920	30965838
9,00	10	66	10	21	0,32	3	SCM840-0900Z03R-R0032HB-HP920	30965839
9,70	10	66	11	22,5	0,32	3	SCM840-0970Z03R-R0032HB-HP920	30965840
10,00	10	66	11	-	0,32	3	SCM840-1000Z03R-R0032HB-HP920	30953712
11,70	12	73	12	24,5	0,32	3	SCM840-1170Z03R-R0032HB-HP920	30965841
12,00	12	73	12	-	0,32	3	SCM840-1200Z03R-R0032HB-HP920	30948678
13,70	14	75	14	26,5	0,32	3	SCM840-1370Z03R-R0032HB-HP920	30965842
14,00	14	75	14	-	0,32	3	SCM840-1400Z03R-R0032HB-HP920	30965843
15,50	16	82	16	30	0,32	3	SCM840-1550Z03R-R0032HB-HP920	30965844
16,00	16	82	16	-	0,32	3	SCM840-1600Z03R-R0032HB-HP920	30965845
17,50	18	84	18	32	0,32	3	SCM840-1750Z03R-R0032HB-HP920	30965846
19,50	20	92	20	38	0,5	3	SCM840-1950Z03R-R0050HB-HP920	30965848
20,00	20	92	20	-	0,5	3	SCM840-2000Z03R-R0050HB-HP920	30965849

\* Corner radius especially for feather key milling according to DIN 6885.

## Available on request

18,00	18	84	18	-	0,32	3	SCM840-1800Z03R-R0032HB-HP920	30965847
-------	----	----	----	---	------	---	-------------------------------	----------

## Configurable features



**Shank form:**  
Shank form: HA



### Specification:

SCM840-0380Z03R-R0012[shank form]-HP920

### Example:

SCM840-0380Z03R-R0012HA-HP920

Shank form HA

Dimensions in mm.

For cutting data recommendations, see end of chapter.

Special designs and other coatings available upon request.



# OptiMill®-Uni-HPC-Pocket

Shoulder milling cutter, long design with neck  
SCM810

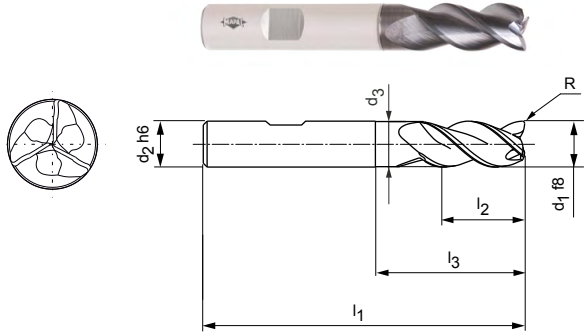

**Design:**

Diameter of milling cutter: 3.80 – 20.00 mm  
Cutting material: HP920  
Number of cutting edges: 3  
Helix angle: ~ 42°  
Special features: Face geometry with integrated drill tip

**Application:**

Perfect for inclined plunging up to 45°, in helix milling and grooving.

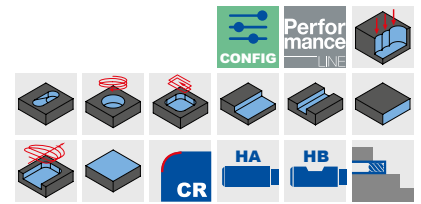

**Preferred series in stock**

Dimensions							z	Specification	Order no.
d1 f8	d2 h6	d3	l1	l2	l3	R			
3,80	6	3,6	57	10	13	0,19	3	SCM810-0380Z03R-R0019HB-HP920	31031147
4,00	6	3,8	57	11	13	0,2	3	SCM810-0400Z03R-R0020HB-HP920	31031148
4,80	6	4,6	57	11	15,5	0,24	3	SCM810-0480Z03R-R0024HB-HP920	31031149
5,00	6	4,8	57	13	15,5	0,25	3	SCM810-0500Z03R-R0025HB-HP920	31031150
5,70	6	5,5	57	13	19	0,29	3	SCM810-0570Z03R-R0029HB-HP920	30788023
6,00	6	5,8	57	13	19	0,3	3	SCM810-0600Z03R-R0030HB-HP920	30788024
6,70	8	6,5	63	16	25	0,34	3	SCM810-0670Z03R-R0034HB-HP920	30788025
7,00	8	6,8	63	16	25	0,35	3	SCM810-0700Z03R-R0035HB-HP920	30788026
7,70	8	7,5	63	19	25	0,39	3	SCM810-0770Z03R-R0039HB-HP920	30788027
8,00	8	7,8	63	19	25	0,4	3	SCM810-0800Z03R-R0040HB-HP920	30788028
8,70	10	8,5	72	22	30	0,44	3	SCM810-0870Z03R-R0044HB-HP920	30788029
9,00	10	8,8	72	22	30	0,45	3	SCM810-0900Z03R-R0045HB-HP920	30788030
9,70	10	9,5	72	22	30	0,49	3	SCM810-0970Z03R-R0049HB-HP920	30788031
10,00	10	9,8	72	22	30	0,5	3	SCM810-1000Z03R-R0050HB-HP920	30788032
11,70	12	11,5	83	26	36	0,59	3	SCM810-1170Z03R-R0059HB-HP920	30788033
12,00	12	11,8	83	26	36	0,6	3	SCM810-1200Z03R-R0060HB-HP920	30788034
13,70	14	13,5	83	26	36	0,69	3	SCM810-1370Z03R-R0069HB-HP920	30788035
14,00	14	13,8	83	26	36	0,7	3	SCM810-1400Z03R-R0070HB-HP920	30788036
15,50	16	15,3	92	31	42	0,78	3	SCM810-1550Z03R-R0078HB-HP920	30788037
16,00	16	15,8	92	31	42	0,8	3	SCM810-1600Z03R-R0080HB-HP920	30788038
17,50	18	17,3	92	31	42	0,88	3	SCM810-1750Z03R-R0088HB-HP920	30788039
18,00	18	17,8	92	31	42	0,9	3	SCM810-1800Z03R-R0090HB-HP920	30788040
19,50	20	19,3	104	41	52	0,98	3	SCM810-1950Z03R-R0098HB-HP920	30788041
20,00	20	19,8	104	41	52	1	3	SCM810-2000Z03R-R0100HB-HP920	30788042

**Configurable features**



**Shank form:**  
Shank form: HA



**Specification:**  
SCM810-0380Z03R-R0019[shank form]-HP920

**Example:**

SCM810-0380Z03R-R0019HA-HP920



Dimensions in mm.

For cutting data recommendations, see end of chapter.

Special designs and other coatings available upon request.

# OptiMill®-Uni-HPC-Pocket

Shoulder milling cutter, overlong design with neck  
SCM800

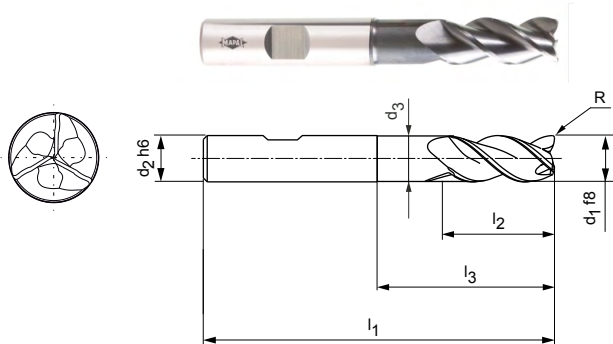

## Design:

Diameter of milling cutter: 5.00 – 20.00 mm  
Cutting material: HP920  
Number of cutting edges: 3  
Helix angle: ~ 42°  
Special features: Face geometry with integrated drill tip

## Application:

Perfect for inclined plunging up to 45°,  
in helix milling and grooving.

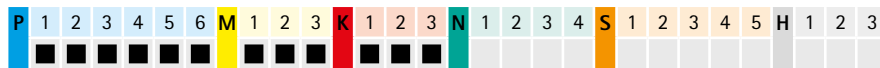
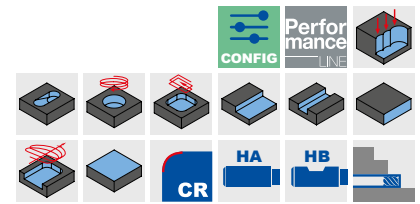

## Preferred series in stock

Dimensions							z	Specification	Order no.
d <sub>1</sub> f8	d <sub>2</sub> h6	d <sub>3</sub>	l <sub>1</sub>	l <sub>2</sub>	l <sub>3</sub>	R			
5,00	6	4,8	62	13	24	0,25	3	SCM800-0500Z03R-R0025HB-HP920	31031146
5,70	6	5,5	62	13	24	0,29	3	SCM800-0570Z03R-R0029HB-HP920	30787957
6,00	6	5,8	62	13	24	0,3	3	SCM800-0600Z03R-R0030HB-HP920	30787958
6,70	8	6,4	68	16	30	0,34	3	SCM800-0670Z03R-R0034HB-HP920	30787959
7,00	8	6,7	68	16	30	0,35	3	SCM800-0700Z03R-R0035HB-HP920	30787960
7,70	8	7,4	68	21	30	0,39	3	SCM800-0770Z03R-R0039HB-HP920	30787961
8,00	8	7,7	68	21	30	0,4	3	SCM800-0800Z03R-R0040HB-HP920	30787962
8,70	10	8,4	80	22	38	0,44	3	SCM800-0870Z03R-R0044HB-HP920	30787963
9,00	10	8,7	80	22	38	0,45	3	SCM800-0900Z03R-R0045HB-HP920	30787964
9,70	10	9,4	80	22	38	0,49	3	SCM800-0970Z03R-R0049HB-HP920	30787965
10,00	10	9,7	80	22	38	0,5	3	SCM800-1000Z03R-R0050HB-HP920	30787966
11,70	12	11,3	93	26	46	0,59	3	SCM800-1170Z03R-R0059HB-HP920	30787967
12,00	12	11,6	93	26	46	0,6	3	SCM800-1200Z03R-R0060HB-HP920	30787968
13,70	14	13,3	99	26	52	0,69	3	SCM800-1370Z03R-R0069HB-HP920	30787969
14,00	14	13,6	99	26	52	0,7	3	SCM800-1400Z03R-R0070HB-HP920	30787970
15,50	16	15	108	36	58	0,78	3	SCM800-1550Z03R-R0078HB-HP920	30787971
16,00	16	15,5	108	36	58	0,8	3	SCM800-1600Z03R-R0080HB-HP920	30787972
17,50	18	17	117	36	67	0,88	3	SCM800-1750Z03R-R0088HB-HP920	30787973
18,00	18	17,5	117	36	67	0,9	3	SCM800-1800Z03R-R0090HB-HP920	30787974
19,50	20	19	126	41	74	0,98	3	SCM800-1950Z03R-R0098HB-HP920	30787975
20,00	20	19,5	126	41	74	1	3	SCM800-2000Z03R-R0100HB-HP920	30787976

## Configurable features



**Shank form:**  
Shank form: HA



**Specification:**  
SCM800-0500Z03R-R0025[shank form]-HP920

## Example:

SCM800-0500Z03R-R0025HA-HP920

Shank form HA

Dimensions in mm.

For cutting data recommendations, see end of chapter.

Special designs and other coatings available upon request.









# OptiMill®-Alu-HPC-Pocket

## Unique face geometry with integrated drill point

The three-edged solid carbide milling cutter OptiMill-Alu-HPC-Pocket has an integrated drill point and is extremely versatile. The OptiMill-Alu-HPC-Pocket is particularly efficient when it comes to producing pockets, inclined plunging or so-called plunging.

- 1 Innovative face geometry**
  - Prevents chip build-up during grooving
- 2 Adapted pitch**
  - Smooth machining in all applications for the best possible surface quality
- 3 Ultra-fine ground flutes**
  - Fast and reliable chip evacuation
- 4 Large chip spaces**
  - Fast and reliable chip evacuation with large chip volumes
- 5 Innovative pointing**
  - Grooving (drilling) Et ramping with very high feed rates

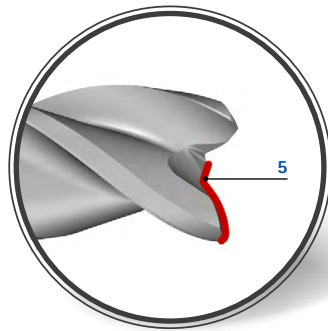

## Features

### Preferred series in stock:

- Design: long version with neck, 3xD with neck and chip breaker
- $\varnothing$ -range: 5,00 - 20,00 mm
- Number of cutting edges: 3 / 4
- Shank form: HB

### Configurable features:

- $\varnothing$ -range: 5,00 - 20,00 mm
- Shank form: HA

## OptiMill-Alu-HPC-Pocket

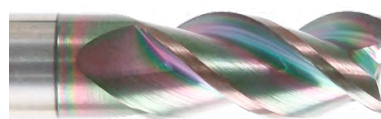

Long design with neck, z=3

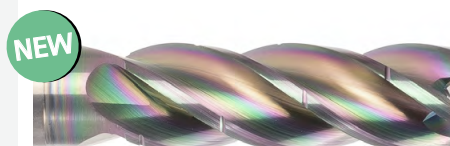

Maximum performance for peripheral milling.  
3xD design, z=4

# OptiMill®-Alu-HPC-Pocket

Shoulder milling cutter, long design with neck  
SCM850

**Design:**

Diameter of milling cutter: 5.00 - 20.00 mm  
Cutting material: HP913  
Number of cutting edges: 3  
Helix angle: 42°  
Special features: Face geometry with integrated drill tip

**Application:**

Perfect for inclined plunging up to 45°,  
in helix milling and grooving.

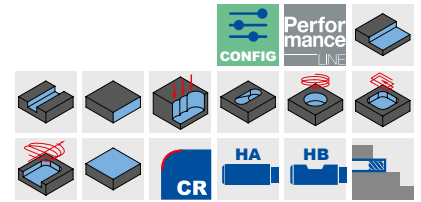
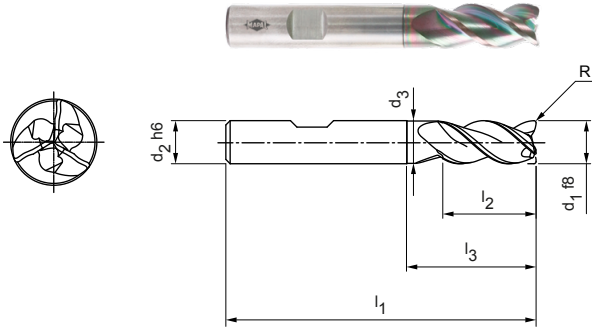

**Preferred series in stock**

Dimensions							z	Specification	Order no.
d <sub>1</sub> f8	d <sub>2</sub> h6	d <sub>3</sub>	l <sub>1</sub>	l <sub>2</sub>	l <sub>3</sub>	R			
5,00	6	4,8	57	13	-	0,2	3	SCM850-0500Z03R-R0020HB-HP913	31054950
6,00	6	5,8	57	13	19	0,2	3	SCM850-0600Z03R-R0020HB-HP913	31054952
8,00	8	7,8	63	19	25	0,2	3	SCM850-0800Z03R-R0020HB-HP913	31054956
10,00	10	9,8	72	22	30	0,32	3	SCM850-1000Z03R-R0032HB-HP913	31054960
12,00	12	11,8	83	26	36	0,32	3	SCM850-1200Z03R-R0032HB-HP913	31054962
14,00	14	13,8	83	26	36	0,32	3	SCM850-1400Z03R-R0032HB-HP913	31054964
16,00	16	15,8	92	31	42	0,32	3	SCM850-1600Z03R-R0032HB-HP913	31054966
20,00	20	19,8	104	41	52	0,5	3	SCM850-2000Z03R-R0050HB-HP913	31054970

Undersize cutters available on request.

**Configurable features**

**Shank form:**  
Shank form: HA

**Specification:**  
SCM850-0500Z03R-R0020[shank form]-HP913

**Example:**

SCM850-0500Z03R-R0020HA-HP913

Shank form HA

Dimensions in mm.

For cutting data recommendations, see end of chapter.

Special designs and other coatings available upon request.



# OptiMill®-Alu-HPC-Pocket

Shoulder milling cutter, 3xD design with neck, includes chip breaker  
SCM854

**Design:**

Diameter of milling cutter: 5.00 - 20.00 mm  
Cutting material: HP913  
Number of cutting edges: 4  
Helix angle: 36°  
Special features: Face geometry with integrated drill tip

**Application:**

Perfect for inclined plunging up to 45°,  
in helix milling and grooving.

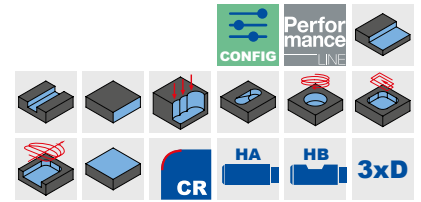
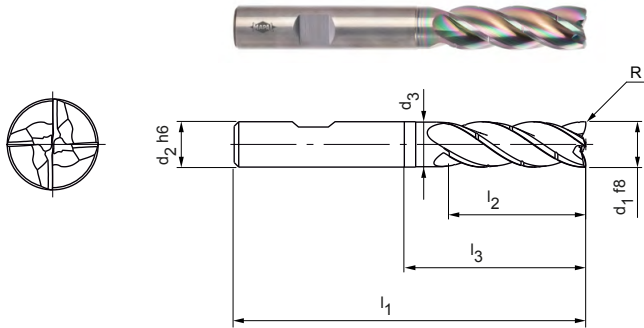

**Preferred series in stock**

Dimensions							z	Specification	Order no.
d1 f8	d2 h6	d3	l1	l2	l3	R			
5,00	6	4,8	62	17	-	0,20	4	SCM854-0500Z04R-R0020HB-HP913	31302680
6,00	6	5,8	62	18	25	0,20	4	SCM854-0600Z04R-R0020HB-HP913	31302681
8,00	8	7,7	68	24	30	0,20	4	SCM854-0800Z04R-R0020HB-HP913	31302682
10,00	10	9,7	80	30	35	0,32	4	SCM854-1000Z04R-R0032HB-HP913	31302683
12,00	12	11,6	93	36	45	0,32	4	SCM854-1200Z04R-R0032HB-HP913	31302684
14,00	14	13,6	99	42	50	0,32	4	SCM854-1400Z04R-R0032HB-HP913	31302685
16,00	16	15,5	108	48	56	0,32	4	SCM854-1600Z04R-R0032HB-HP913	31302686
20,00	20	19,5	126	60	70	0,50	4	SCM854-2000Z04R-R0050HB-HP913	31302688

**Available on request**

18,00	18	17,5	117	54	67	0,32	4	SCM854-1800Z04R-R0032HB-HP913	31302687
-------	----	------	-----	----	----	------	---	-------------------------------	----------

**Configurable features**

**Shank form:**  
Shank form: HA

**Specification:**  
SCM854-0500Z04R-R0020[shank form]-HP913

**Example:**

SCM854-0500Z04R-R0020HA-HP913

Shank form HA

Dimensions in mm.

For cutting data recommendations, see end of chapter.

Special designs and other coatings available upon request.

# A strong team: OptiMill®-Alu-HPC-Pocket and MillChuck HB

## 1 Decentralised coolant channels

- Optimal coolant supply

## 2 Differential screw

- Easy to handle

## 3 Spring package

- Perfect connection to the HB clamping surface

## 4 Contour

- Application-optimised contour for maximum rigidity

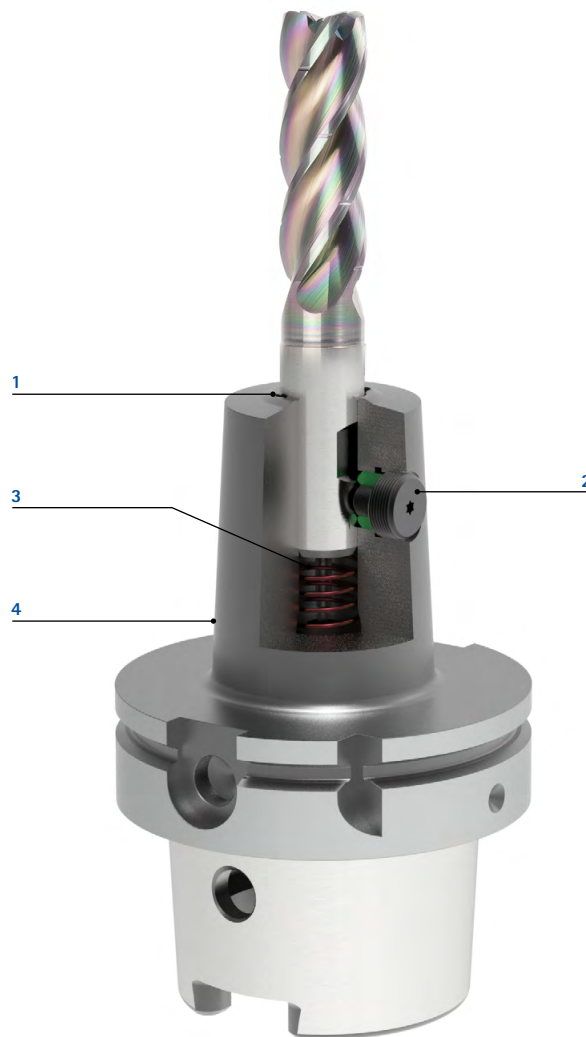

### Optimal coolant supply

- Decentralised coolant channels
- Use of standard tools without internal cooling
- Tool life improved thanks to optimal cooling



### Process-reliable tool clamping

- High clamping force thanks to two-part clamping element
- Differential screw for reduced tightening torque
- Process-reliable clamping through self-locking

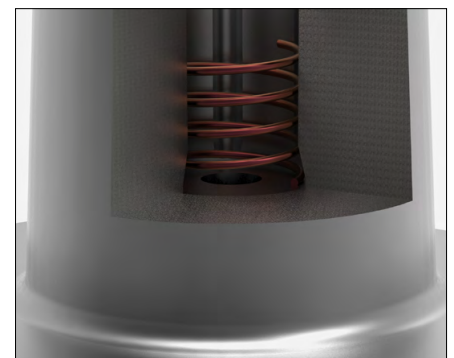

### Defined milling cutter positioning

- Perfect connection to the HB clamping surface
- Form fit between tool and adapter
- Prevents any pull-out during machining

# MillChuck, HB

HSK-A (hollow shank taper form A) shank according to DIN 69893-1

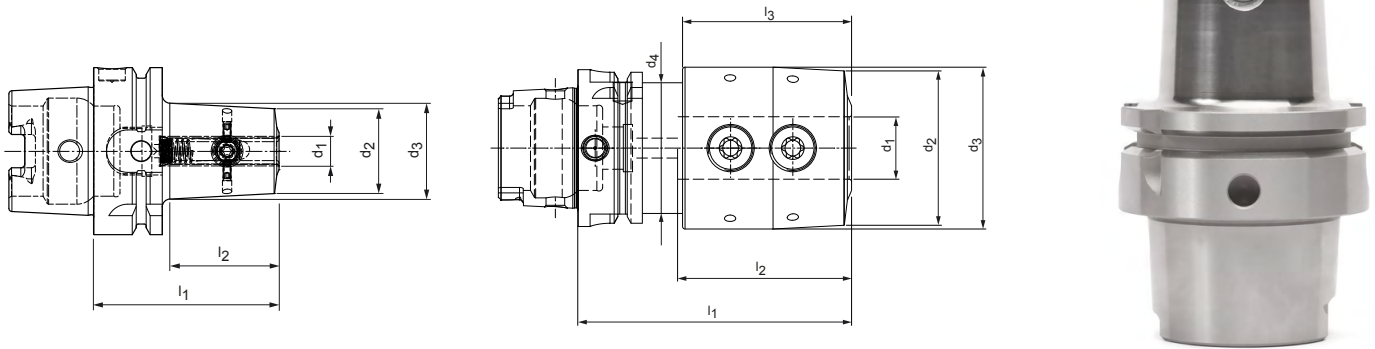

HSK-A	Dimensions							Specification	Order no.
	d <sub>1</sub>	d <sub>2</sub>	d <sub>3</sub>	d <sub>4</sub>	l <sub>1</sub>	l <sub>2</sub>	l <sub>3</sub>		
63	6,0	22,5	26,2	-	65,0	36,2	-	MWC-HSK-A063-06-065-1-0-W	30941344
63	8,0	25,0	28,7	-	65,0	36,2	-	MWC-HSK-A063-08-065-1-0-W	30941345
63	10,0	32,0	36,2	-	70,0	41,2	-	MWC-HSK-A063-10-070-1-0-W	30941346
63	12,0	37,5	42,7	-	80,0	51,2	-	MWC-HSK-A063-12-080-1-0-W	30941347
63	16,0	43,0	48,3	-	80,0	52,2	-	MWC-HSK-A063-16-080-1-0-W	30941349
63	20,0	46,5	52,0	-	80,0	54,0	-	MWC-HSK-A063-20-080-1-0-W	30941371
63	25,0	62,0	65,0	52,5	110,0	69,9	68,0	MWC-HSK-A063-25-110-1-0-W	30941372
63	32,0	69,0	72,0	52,5	110,0	69,9	68,0	MWC-HSK-A063-32-110-1-0-W	30941373
100	6,0	22,5	27,5	-	80,0	48,2	-	MWC-HSK-A100-06-080-1-0-W	30941374
100	8,0	25,0	30,0	-	80,0	48,2	-	MWC-HSK-A100-08-080-1-0-W	30941375
100	10,0	32,0	36,9	-	80,0	48,2	-	MWC-HSK-A100-10-080-1-0-W	30941376
100	12,0	37,5	42,9	-	85,0	53,2	-	MWC-HSK-A100-12-085-1-0-W	30941377
100	16,0	43,0	50,0	-	100,0	68,2	-	MWC-HSK-A100-16-100-1-0-W	30941379
100	20,0	46,5	53,5	-	100,0	68,2	-	MWC-HSK-A100-20-100-1-0-W	30941381
100	25,0	62,0	65,0	-	100,0	68,1	-	MWC-HSK-A100-25-100-1-0-W	30941382
100	32,0	69,0	72,0	-	110,0	78,1	-	MWC-HSK-A100-32-110-1-0-W	30925430

Dimensions in mm.

Additional dimensions available upon request.

Use: For clamping milling cutters with cylindrical shank and lateral drive area according to DIN 1835 Form B and DIN 6535 Form HB.

Scope of delivery: With built-in clamping screw, without coolant tube.

Design: Permissible run-out variation of the taper to the location bore  $d_1 = 3 \mu\text{m}$ .

The bore tolerance is much more restricted than DIN 1835 in order to achieve machining accuracies of the highest quality.

Note: There are two clamping screws from clamping diameter  $d_1 = 25 \text{ mm}$ .

Balancing quality: G 2.5 with 16,000 rpm in delivery status.



# MillChuck, HB

Shank SK according to ISO 7388-1 Form AD/AF

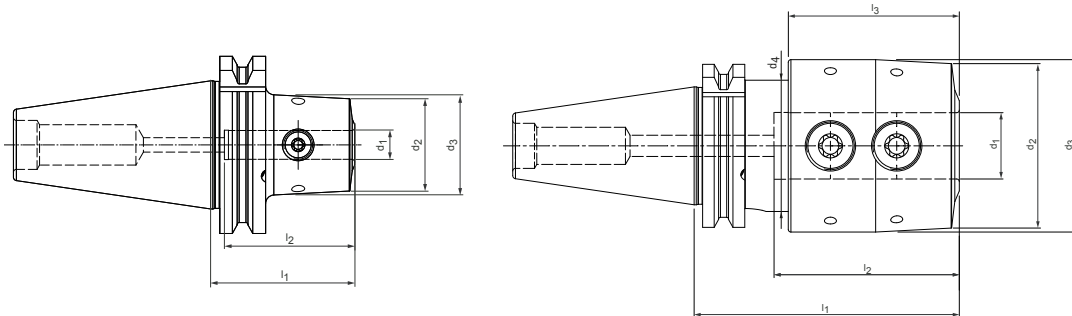

Steep taper	Dimensions							Specification	Order no.
	d <sub>1</sub>	d <sub>2</sub>	d <sub>3</sub>	d <sub>4</sub>	l <sub>1</sub>	l <sub>2</sub>	l <sub>3</sub>		
40	6,0	22,5	25,4	-	50,0	28,1	-	MWC-SK040-06-050-3-0-W	31059420
40	8,0	25,0	27,9	-	50,0	28,1	-	MWC-SK040-08-050-3-0-W	31059421
40	10,0	32,0	34,8	-	50,0	28,1	-	MWC-SK040-10-050-3-0-W	31059422
40	12,0	37,5	40,3	-	50,0	28,1	-	MWC-SK040-12-050-3-0-W	31059423
40	16,0	43,0	47,3	-	63,0	43,0	-	MWC-SK040-16-063-3-0-W	31059425
40	20,0	46,5	49,5	-	63,0	43,0	-	MWC-SK040-20-063-3-0-W	31059427
40	25,0	62,0	65,0	49,5	100,0	69,9	64,5	MWC-SK040-25-100-3-0-W	31059428
40	32,0	69,0	72,0	49,5	100,0	69,9	64,5	MWC-SK040-32-100-3-0-W	31059429
50	6,0	22,5	26,7	-	63,0	41,1	-	MWC-SK050-06-063-3-0-W	31059430
50	8,0	25,0	29,2	-	63,0	41,1	-	MWC-SK050-08-063-3-0-W	31059431
50	10,0	32,0	36,2	-	63,0	41,1	-	MWC-SK050-10-063-3-0-W	31059432
50	12,0	37,5	41,7	-	63,0	41,1	-	MWC-SK050-12-063-3-0-W	31059433
50	16,0	43,0	47,1	-	63,0	41,1	-	MWC-SK050-16-063-3-0-W	31059435
50	20,0	46,5	50,6	-	63,0	41,1	-	MWC-SK050-20-063-3-0-W	31059437
50	25,0	62,0	67,8	-	80,0	58,1	-	MWC-SK050-25-080-3-0-W	31059438
50	32,0	69,0	76,9	-	100,0	78,1	-	MWC-SK050-32-100-3-0-W	31059439

Dimensions in mm.

Additional dimensions available upon request.

Use: For clamping milling cutters with cylindrical shank and lateral drive area according to DIN 1835 Form B and DIN 6535 Form HB.

Scope of delivery: Built-in clamping screw, does not include pull stud.

Design: Permissible run-out variation of the taper to the location bore  $d_1 = 3 \mu\text{m}$ .

The bore tolerance is much more restricted than DIN 1835 in order to achieve machining accuracies of the highest quality.

Note: There are two clamping screws from clamping diameter  $d_1 = 25 \text{ mm}$ .

Balancing quality: G 2.5 with 16,000 rpm in delivery status.

# Cutting data recommendations for shoulder milling cutters

Feed and cutting speed

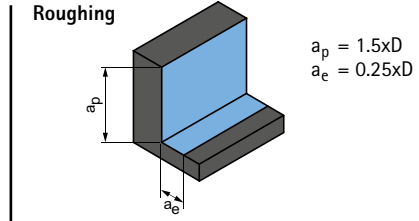

## OptiMill-Uni-HPC-Pocket | SCM800, 810, 813, 840

MMG*	Workpiece material	Strength/hardness [N/mm <sup>2</sup> ] [HRC]	Cooling			v <sub>c</sub> [m/min]	f <sub>z</sub> [mm]							
			MQL/Air	Dry	Coolant		Diameter of milling cutter [mm]							
							3.80	6.00	8.00	10.00	12.00	16.00	20.00	
P	P1.1	Structural, free-cutting, case hardened and heat-treated steels, non-alloy	< 700	✓	✓	✓	465	0.053	0.079	0.101	0.122	0.140	0.171	0.195
	P1.2	Structural, free-cutting, case hardened and heat-treated steels, non-alloy	< 1,200	✓	✓	✓	380	0.049	0.074	0.095	0.113	0.130	0.159	0.182
	P2.1	Nitrided, case hardened and heat-treated steels, alloy	< 900	✓	✓	✓	425	0.053	0.079	0.101	0.122	0.140	0.171	0.195
	P2.2	Nitrided, case hardened and heat-treated steels, alloy	< 1,400	✓		✓	295	0.044	0.066	0.085	0.101	0.116	0.142	0.163
	P3.1	Tool, bearing, spring and high-speed steels**	< 800	✓	✓	✓	275	0.051	0.077	0.098	0.117	0.135	0.165	0.189
	P3.2	Tool, bearing, spring and high-speed steels**	< 1,000	✓		✓	255	0.048	0.073	0.093	0.111	0.128	0.156	0.179
	P3.3	Tool, bearing, spring and high-speed steels**	< 1,500	✓		✓	235	0.046	0.069	0.088	0.105	0.121	0.148	0.169
	P4.1	Stainless steels, ferritic and martensitic		✓		✓	190	0.035	0.053	0.068	0.081	0.093	0.114	0.130
	P5.1	Cast steel				✓	285	0.051	0.077	0.098	0.117	0.135	0.165	0.189
	P6.1	Stainless cast steel, ferritic and martensitic				✓	190	0.025	0.037	0.047	0.057	0.065	0.080	0.091
M	M1.1	Stainless steels, austenitic	< 700	✓		✓	125	0.031	0.046	0.059	0.071	0.081	0.100	0.114
	M1.2	Stainless steels, ferritic/austenitic (duplex)	< 1,000			✓	120	0.025	0.038	0.049	0.059	0.068	0.082	0.094
	M2.1	Stainless/heat-resistant cast steel, austenitic	< 700	✓		✓	140	0.033	0.050	0.064	0.077	0.088	0.108	0.124
	M3.1	Stainless cast steel, ferritic/austenitic (duplex)	< 1,000			✓	125	0.026	0.040	0.051	0.061	0.070	0.085	0.098
K	K1.1	Cast iron with lamellar graphite (grey cast iron), GJL	< 300	✓	✓	✓	510	0.088	0.132	0.169	0.203	0.233	0.284	0.325
	K2.1	Cast iron with spheroidal graphite, GJS	< 500	✓	✓	✓	465	0.075	0.113	0.144	0.172	0.198	0.242	0.276
	K2.2	Cast iron with spheroidal graphite, GJS	≤ 800	✓	✓	✓	380	0.062	0.093	0.118	0.142	0.163	0.199	0.228
	K2.3	Cast iron with spheroidal graphite, GJS	> 800	✓	✓	✓	210	0.035	0.053	0.068	0.081	0.093	0.114	0.130
	K3.1	Cast iron with spheroidal graphite, GJV; malleable cast iron, GJM	< 500	✓	✓	✓	340	0.062	0.093	0.118	0.142	0.163	0.199	0.228
	K3.2	Cast iron with spheroidal graphite, GJV; malleable cast iron, GJM	> 500	✓	✓	✓	315	0.053	0.079	0.101	0.122	0.140	0.171	0.195

### Tool length/correction factor

Length	f <sub>z</sub> & v <sub>c</sub>
Short	1
Long	1
Overlong	0.8
Extra long	-

\* MAPAL machining groups

\*\* If the alloy parts Cr, Mo, Ni, V, W in total > 8%, then select the next highest MAPAL machining group.

Groove milling

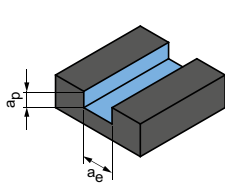

$$a_p = 1 \times D$$

$$a_e = 1 \times D$$

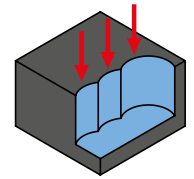
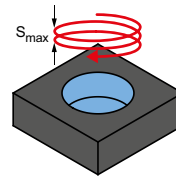
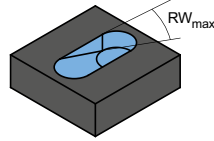

$v_c$ [m/min]	$f_z$ [mm]								Ramps	Helix milling		Drilling	
	Diameter of milling cutter [mm]								$RW_{max}$	$S_{max}$	$EW_{max}$		$f_z$ factor
	3.80	6.00	8.00	10.00	12.00	16.00	20.00	G = 1.5			G = 1.8		
230	0.031	0.047	0.060	0.072	0.082	0.101	0.115	45°	0.75xD	25°	16°	0.9	
185	0.029	0.044	0.056	0.067	0.077	0.094	0.107	45°	0.75xD	25°	16°	0.8	
205	0.031	0.047	0.060	0.072	0.082	0.101	0.115	45°	0.75xD	25°	16°	0.8	
145	0.026	0.039	0.050	0.060	0.069	0.084	0.096	45°	0.75xD	25°	16°	0.7	
135	0.030	0.045	0.058	0.069	0.080	0.097	0.111	30°	0.5xD	18°	11°	0.8	
125	0.029	0.043	0.055	0.066	0.075	0.092	0.105	30°	0.5xD	18°	11°	0.7	
115	0.027	0.041	0.052	0.062	0.071	0.087	0.100	30°	0.5xD	18°	11°	0.7	
95	0.021	0.031	0.040	0.048	0.055	0.067	0.077	15°	0.5xD	18°	11°		
140	0.030	0.045	0.058	0.069	0.080	0.097	0.111	30°	0.5xD	18°	11°		
95	0.015	0.022	0.028	0.033	0.038	0.047	0.054	15°	0.5xD	18°	11°		
60	0.018	0.027	0.035	0.042	0.048	0.059	0.067	15°	0.5xD	18°	11°		
60	0.015	0.023	0.029	0.035	0.040	0.049	0.056	15°	0.5xD	18°	11°		
70	0.020	0.030	0.038	0.045	0.052	0.064	0.073	15°	0.5xD	18°	11°		
60	0.016	0.023	0.030	0.036	0.041	0.050	0.058	15°	0.5xD	18°	11°		
250	0.052	0.078	0.100	0.119	0.137	0.168	0.192	45°	0.75xD	25°	16°	0.8	
230	0.044	0.066	0.085	0.102	0.117	0.143	0.163	45°	0.75xD	25°	16°	0.8	
185	0.036	0.055	0.070	0.084	0.096	0.117	0.134	45°	0.75xD	25°	16°	0.8	
105	0.021	0.031	0.040	0.048	0.055	0.067	0.077	45°	0.75xD	25°	16°	0.8	
165	0.036	0.055	0.070	0.084	0.096	0.117	0.134	45°	0.75xD	25°	16°	0.8	
155	0.031	0.047	0.060	0.072	0.082	0.101	0.115	45°	0.75xD	25°	16°	0.8	

Explanation of terms:

$RW_{max}$  = Maximum angle of the ramp

$S_{max}$  = Maximum slope of the helix

G = Ratio of circular pocket  $\emptyset$  when plunging to the tool  $\emptyset$

E.g.: Tool  $\emptyset$  12 mm at G=1.5 results in a pocket  $\emptyset$  of 18 mm

$EW_{max}$  = Slope angle of the helix (results from G and  $S_{max}$ )

The specified machining values are guide values.

The optimum data for the respective machining task should be determined during the test or machining.



# Cutting data recommendations for shoulder milling cutters

Feed and cutting speed

## OptiMill-Uni-HPC-Pocket | SCM800, 810, 813, 840

MMG*	Workpiece material	Strength/hardness [N/mm <sup>2</sup> ] [HRC]	Cooling				
			MQL/Air	Dry	Coolant		
P	P1.1	Structural, free-cutting, case hardened and heat-treated steels, non-alloy	< 700	✓	✓	✓	
	P1.2	Structural, free-cutting, case hardened and heat-treated steels, non-alloy	< 1,200	✓	✓	✓	
	P2.1	Nitrided, case hardened and heat-treated steels, alloy	< 900	✓	✓	✓	
	P2.2	Nitrided, case hardened and heat-treated steels, alloy	< 1,400	✓		✓	
	P3.1	Tool, bearing, spring and high-speed steels**	< 800	✓	✓	✓	
	P3.2	Tool, bearing, spring and high-speed steels**	< 1,000	✓		✓	
	P3.3	Tool, bearing, spring and high-speed steels**	< 1,500	✓		✓	
	P4.1	Stainless steels, ferritic and martensitic		✓		✓	
	P5.1	Cast steel					
	P6.1	Stainless cast steel, ferritic and martensitic				✓	
	K	K1.1	Cast iron with lamellar graphite (grey cast iron), GJL	< 300	✓	✓	✓
		K2.1	Cast iron with spheroidal graphite, GJS	< 500	✓	✓	✓
K2.2		Cast iron with spheroidal graphite, GJS	≤ 800	✓	✓	✓	
K2.3		Cast iron with spheroidal graphite, GJS	> 800	✓	✓	✓	
K3.1		Cast iron with spheroidal graphite, GJV; malleable cast iron, GJM	< 500	✓	✓	✓	
K3.2		Cast iron with spheroidal graphite, GJV; malleable cast iron, GJM	> 500	✓	✓	✓	

### Calculation example for 42CrMo4 ø 12 mm:

$$f_z | a_e | h_m \text{ max.} = \frac{D}{100} \cdot \text{See table for value}$$

P2.2	Nitrided, case hardened and heat-treated steels, alloy	< 1400	✓	✓	280 - 380	1.0 - 1.6	8 - 12	0.56 - 0.68
------	--	--------	---	---	-----------	-----------	--------	-------------

$$1 \quad f_z = \frac{12 \text{ mm}}{100} \cdot 1,2 = 0,144 \text{ mm}$$

$$2 \quad a_e = \frac{12 \text{ mm}}{100} \cdot 10 = 1,2 \text{ mm}$$

$$3 \quad h_m \text{ max.} = \frac{12 \text{ mm}}{100} \cdot 0,6 = 0,072 \text{ mm}$$

#### Note:

In the case of trochoidal milling, the specified cutting conditions change during the machining process. This also depends on the CAM software used and the machining position of the tool in the workpiece. The feed and cutting width or contact angle are constantly changing during machining in order to achieve, as far as is possible, the most constant average chip thickness depending on the contour.

\* MAPAL machining groups

\*\* If the alloy parts Cr, Mo, Ni, V, W in total > 8%, then select the next highest MAPAL machining group.

**Trochoidal milling**

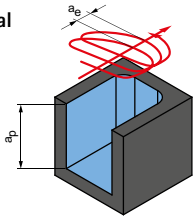

$a_p$  = depending on max. machining depth of the tool  
 $a_e$  = depending on the workpiece material

$v_c$ [m/min]	$f_z$ [mm] in % of D	$a_e$ [mm] in % of D	$h_m$ max. [mm] in % of D	Machining example	
380 - 520	1.4 - 2.0	14 - 18	0.66 - 0.80	<b>16MnCr5</b> $\varnothing = 12$ mm $v_c = 500$ m/min $f_z = 0.28$ mm $a_e = 1.8$ mm $a_p = 32$ mm	<b>42CrMo4</b> $\varnothing = 12$ mm $v_c = 375$ m/min $f_z = 0.17$ mm $a_e = 1.2$ mm $a_p = 32$ mm
320 - 460	1.2 - 1.8	12 - 16	0.62 - 0.76		
340 - 480	1.2 - 1.8	10 - 14	0.58 - 0.71		
280 - 380	1.0 - 1.6	8 - 12	0.56 - 0.68		
250 - 360	1.1 - 1.7	9 - 15	0.56 - 0.67		
230 - 340	0.9 - 1.5	8 - 13	0.54 - 0.64		
210 - 320	0.8 - 1.4	6 - 12	0.52 - 0.62		
180 - 260	0.8 - 1.2	6 - 12	0.50 - 0.60		
220 - 300	1.2 - 1.8	8 - 12	0.54 - 0.62		
160 - 240	0.8 - 1.4	6 - 12	0.50 - 0.60		
400 - 500	2.0 - 2.6	15 - 20	0.64 - 0.78		
340 - 500	1.8 - 2.4	12 - 16	0.62 - 0.7		
300 - 440	1.6 - 2.2	10 - 14	0.58 - 0.68		
180 - 260	1.4 - 2.0	8 - 12	0.56 - 0.68		
280 - 360	1.6 - 2.2	10 - 16	0.6 - 0.68		
210 - 340	1.4 - 2.0	10 - 16	0.58 - 0.66		

The specified machining values are guide values.  
 The optimum data for the respective machining task should be determined during the test or machining.

# Cutting data recommendations for shoulder milling cutters

Feed and cutting speed

Part-contact cutting

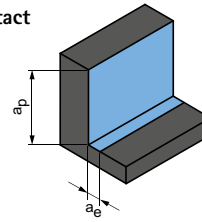

$$a_p = 1.5 \times D$$

$$a_e = 0.25 \times D$$

## OptiMill-Alu-HPC-Pocket | SCM850

MMG*	Workpiece material	Strength/hardness [N/mm <sup>2</sup> ] [HRC]	Cooling			v <sub>c</sub> [m/min]	f <sub>z</sub> [mm]						
			MQL/Air	Dry	Coolant		Diameter of milling cutter [mm]						
							5.00	8.00	10.00	12.00	16.00	20.00	
N	N1	N1.1 Aluminium, non-alloy and alloy < 3 % Si	✓	✓	✓	945	0.080	0.120	0.145	0.169	0.210	0.243	
		N1.2 Aluminium, alloy ≤ 7 % Si	✓	✓	✓	625	0.084	0.126	0.152	0.177	0.221	0.256	
		N1.3 Aluminium, alloy > 7-12 % Si	✓	✓	✓	500	0.088	0.132	0.160	0.186	0.231	0.268	
		N1.4 Aluminium, alloy > 12 % Si	✓	✓	✓	360	0.096	0.144	0.174	0.202	0.252	0.292	
	N2	N2.1 Copper, non-alloy and low-alloy	< 300	✓	✓	✓	360	0.064	0.096	0.116	0.135	0.168	0.195
		N2.2 Copper, alloy	> 300	✓	✓	✓	270	0.064	0.096	0.116	0.135	0.168	0.195
		N2.3 Brass, bronze, gunmetal	< 1,200	✓	✓	✓	450	0.040	0.060	0.073	0.084	0.105	0.122
	N4	N4.1 Plastic, thermoplastics		✓	✓	✓	125	0.040	0.060	0.073	0.084	0.105	0.122
		N4.2 Plastic, thermosets		✓	✓	✓	185	0.040	0.060	0.073	0.084	0.105	0.122
		N4.3 Plastic, foams		✓	✓		565	0.024	0.036	0.044	0.051	0.063	0.073

Part-contact cutting

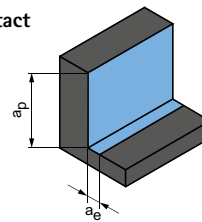

$$a_p = 3 \times D$$

$$a_e = 0.1 \times D$$

## OptiMill-Alu-HPC-Pocket | SCM854

MMG*	Workpiece material	Strength/hardness [N/mm <sup>2</sup> ] [HRC]	Cooling			v <sub>c</sub> [m/min]	f <sub>z</sub> [mm]								
			MQL/Air	Dry	Coolant		Diameter of milling cutter [mm]								
							5.00	8.00	10.00	12.00	14.00	16.00	18.00	20.00	
N	N1	N1.1 Aluminium, non-alloy and alloy < 3 % Si	✓	✓	✓	915	0.061	0.091	0.110	0.126	0.141	0.154	0.166	0.176	
		N1.2 Aluminium, alloy ≤ 7 % Si	✓	✓	✓	610	0.064	0.096	0.115	0.132	0.148	0.162	0.174	0.185	
		N1.3 Aluminium, alloy > 7-12 % Si	✓	✓	✓	485	0.067	0.101	0.121	0.139	0.155	0.169	0.182	0.193	
		N1.4 Aluminium, alloy > 12 % Si	✓	✓	✓	350	0.073	0.110	0.131	0.151	0.169	0.185	0.199	0.211	
	N2	N2.1 Copper, non-alloy and low-alloy	< 300	✓	✓	✓	350	0.049	0.073	0.088	0.101	0.113	0.123	0.132	0.141
		N2.2 Copper, alloy	> 300	✓	✓	✓	265	0.049	0.073	0.088	0.101	0.113	0.123	0.132	0.141
		N2.3 Brass, bronze, gunmetal	< 1,200	✓	✓	✓	440	0.030	0.046	0.055	0.063	0.070	0.077	0.083	0.088
	N4	N4.1 Plastic, thermoplastics		✓	✓	✓	120	0.030	0.046	0.055	0.063	0.070	0.077	0.083	0.088
		N4.2 Plastic, thermosets		✓	✓	✓	180	0.030	0.046	0.055	0.063	0.070	0.077	0.083	0.088
		N4.3 Plastic, foams		✓	✓		315	0.018	0.027	0.033	0.038	0.042	0.046	0.050	0.053

\* MAPAL machining groups

Full cutting

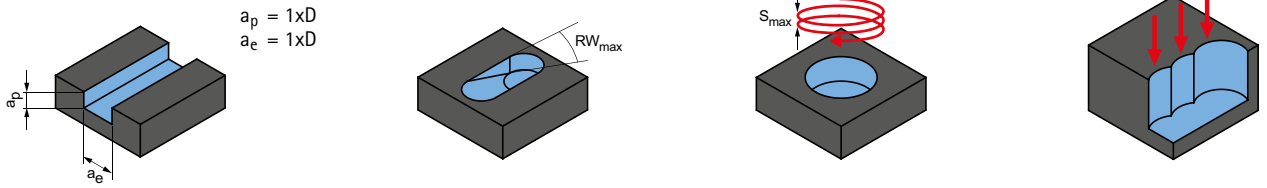

$v_c$ [m/min]	$f_z$ [mm]						Ramps	Helix milling		Drilling	
	Diameter of milling cutter [mm]						$RW_{max}$	$S_{max}$	$EW_{max}$		$f_z$ factor
	5.00	8.00	10.00	12.00	16.00	20.00			G = 1.5	G = 1.8	
610	0.047	0.071	0.086	0.099	0.124	0.144	45°	0.75xD	25°	16°	0.8
405	0.049	0.074	0.090	0.104	0.130	0.151	45°	0.75xD	25°	16°	0.8
325	0.052	0.078	0.094	0.109	0.136	0.158	45°	0.75xD	25°	16°	0.8
235	0.057	0.085	0.103	0.119	0.149	0.172	45°	0.75xD	25°	16°	0.8
235	0.038	0.057	0.068	0.080	0.099	0.115	45°	0.75xD	25°	16°	0.8
175	0.038	0.057	0.068	0.080	0.099	0.115	45°	0.75xD	25°	16°	0.8
295	0.024	0.035	0.043	0.050	0.062	0.072	45°	0.75xD	25°	16°	0.8
80	0.024	0.035	0.043	0.050	0.062	0.072	45°	0.75xD	25°	16°	0.8
120	0.024	0.035	0.043	0.050	0.062	0.072	45°	0.75xD	25°	16°	0.8
365	0.014	0.021	0.026	0.030	0.037	0.043	45°	0.75xD	25°	16°	0.8

Full cutting

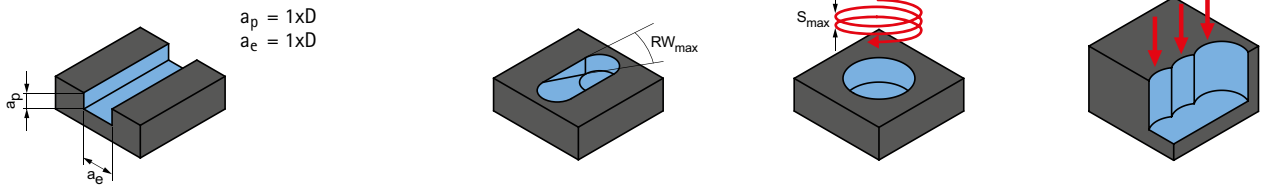

$v_c$ [m/min]	$f_z$ [mm]								Ramps	Helix milling		Grooving	
	Diameter of milling cutter [mm]								$RW_{max}$	$S_{max}$	$EW_{max}$		$f_z$ factor
	5.00	8.00	10.00	12.00	14.00	16.00	18.00	20.00			G = 1.5	G = 1.8	
495	0.045	0.068	0.081	0.093	0.104	0.114	0.123	0.130	45°	0.75xD	25°	16°	0.8
330	0.047	0.071	0.085	0.098	0.109	0.120	0.129	0.137	45°	0.75xD	25°	16°	0.8
265	0.050	0.075	0.089	0.103	0.115	0.125	0.135	0.143	45°	0.75xD	25°	16°	0.8
190	0.054	0.081	0.097	0.112	0.125	0.137	0.147	0.156	45°	0.75xD	25°	16°	0.8
190	0.036	0.054	0.065	0.075	0.083	0.091	0.098	0.104	45°	0.75xD	25°	16°	0.8
145	0.036	0.054	0.065	0.075	0.083	0.091	0.098	0.104	45°	0.75xD	25°	16°	0.8
240	0.023	0.034	0.041	0.047	0.052	0.057	0.061	0.065	45°	0.75xD	25°	16°	0.8
65	0.023	0.034	0.041	0.047	0.052	0.057	0.061	0.065	45°	0.75xD	25°	16°	0.8
100	0.023	0.034	0.041	0.047	0.052	0.057	0.061	0.065	45°	0.75xD	25°	16°	0.8
170	0.014	0.020	0.024	0.028	0.031	0.034	0.037	0.039	45°	0.75xD	25°	16°	0.8

Explanation of terms:

$RW_{max}$  = Maximum angle of the ramp

$S_{max}$  = Maximum slope of the helix

G = Ratio of circular pocket  $\emptyset$  when plunging to the tool  $\emptyset$

E.g.: Tool  $\emptyset$  12 mm at G=1.5 results in a pocket  $\emptyset$  of 18 mm

$EW_{max}$  = Slope angle of the helix (results from G and  $S_{max}$ )



# Cutting data recommendations for shoulder milling cutters

Feed and cutting speed

## OptiMill-Alu-HPC-Pocket | SCM854

MMG*	Workpiece material	Strength/hardness [N/mm <sup>2</sup> ] [HRC]	Cooling			
			MQL/Air	Dry	Coolant	
N	N1	N1.1 Aluminium, non-alloy and alloy < 3 % Si	✓	✓	✓	
		N1.2 Aluminium, alloy ≤ 7 % Si	✓	✓	✓	
		N1.3 Aluminium, alloy > 7-12 % Si	✓	✓	✓	
		N1.4 Aluminium, alloy > 12 % Si	✓	✓	✓	
	N2	N2.1 Copper, non-alloy and low-alloy	< 300	✓	✓	✓
		N2.2 Copper, alloy	> 300	✓	✓	✓
		N2.3 Brass, bronze, gunmetal	< 1,200	✓	✓	✓
	N4	N4.1 Plastic, thermoplastics		✓	✓	✓
		N4.2 Plastic, thermosets		✓	✓	✓
		N4.3 Plastic, foams		✓	✓	

### Calculation example for AL99 ø 12 mm:

$$f_z \mid h_m \text{ max.} = \frac{D}{100} \cdot \text{See table for value}$$

N1.1	Aluminium, non-alloy and alloy < 3 % Si	✓	✓	✓	810	0.7 - 0.9	1.12
------	---	---	---	---	-----	-----------	------

$$1 \quad f_z = \frac{12 \text{ mm}}{100} \cdot 0,8 = 0,096 \text{ mm}$$

$$2 \quad h_m \text{ max.} = \frac{12 \text{ mm}}{100} \cdot 1,12 = 0,134 \text{ mm}$$

**Note:**

In the case of trochoidal milling, the specified cutting conditions change during the machining process. This also depends on the CAM software used and the machining position of the tool in the workpiece. The feed and cutting width or contact angle are constantly changing during machining in order to achieve, as far as is possible, the most constant average chip thickness depending on the contour.

\* MAPAL machining groups

Trochoidal milling

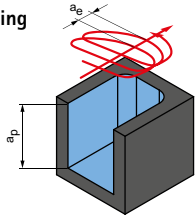

$$a_p = 3 \times D$$

$$a_e = 0.1 \times D$$

Trochoidal milling

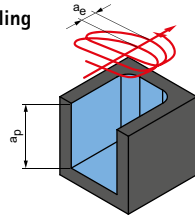

$$a_p = 3 \times D$$

$$a_e = 0.2 \times D$$

$v_c$ [m/min]	$f_z$ [mm] in % of D	$h_{max}$ [mm] in % of D	$v_c$ [m/min]	$f_z$ [mm] in % of D	$h_{max}$ [mm] in % of D
915	0.1 - 1.4	0.84	810	0.7 - 0.9	1.12
610	0.1 - 1.5	0.90	540	0.7 - 1.0	1.20
485	1.0 - 1.3	0.78	430	0.8 - 1.0	1.04
350	1.1 - 1.5	0.90	310	0.8 - 1.1	1.20
350	0.7 - 1.0	0.60	310	0.5 - 0.8	0.80
265	0.7 - 1.0	0.60	235	0.5 - 0.8	0.80
440	0.4 - 0.6	0.36	390	0.3 - 0.5	0.48
120	0.4 - 0.6	0.36	105	0.3 - 0.5	0.48
180	0.4 - 0.6	0.36	160	0.3 - 0.5	0.48
315	0.3 - 0.4	0.24	280	0.2 - 0.3	0.32

**Explanation of terms:**

$RW_{max}$  = Maximum angle of the ramp

$S_{max}$  = Maximum slope of the helix

$G$  = Ratio of circular pocket  $\emptyset$  when plunging to the tool  $\emptyset$

E.g.: Tool  $\emptyset$  12 mm at  $G=1.5$  results in a pocket  $\emptyset$  of 18 mm

$EW_{max}$  = Slope angle of the helix (results from  $G$  and  $S_{max}$ )



Discover tool and service solutions now that give you a lead:

## BORE MACHINING

REAMING | FINE BORING

DRILLING FROM SOLID | BORING | COUNTERSINKING

MILLING

CLAMPING

TURNING

ACTUATING

SETTING | MEASURING | DISPENSING

SERVICES

Mat. no. 10175773 | V1.0.0  
Pocket-EN-PC-01-005-0325-VVA Printed in Austria. Technical data subject to change without notice.  
© MAPAL Dr. Kress KG | Reprinting, in whole or in part, only with the approval of the publisher.

FOLLOW US



Print product with financial  
**climate contribution**  
ClimatePartner.com/53385-2410-107

