

Your technology partner for cost-effective machining

# OptiMill<sup>®</sup> - Composite-Speed-Plus

# OptiMill®-Composite-Speed-Plus

## A new dimension of process reliability

The OptiMill-Composite-Speed-Plus features a new diamond coating developed by MAPAL with even distribution and higher coating thickness. The bigger core diameter increases fracture strength by 50 percent. The improved groove profile ensures efficient, reliable removal of dust and process heat even when machining large volumes. The cutting wedge has been specially optimised to meet the requirements of brittle workpiece material. The special cutting-edge serration causes double compression so that fibre fraying on the workpiece edges of the upper and lower sides are reliably separated.

This allows the OptiMill-Composite-Speed-Plus to attain a new dimension in process reliability. Compared to the OptiMill-Composite-Speed, 20 percent longer tool life is achieved.

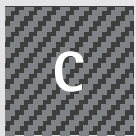

Composite materials



Graphites, thermosets

## PROCESS RELIABILITY

### Increased fracture strength

NEW



OptiMill®-Composite-Speed-Plus

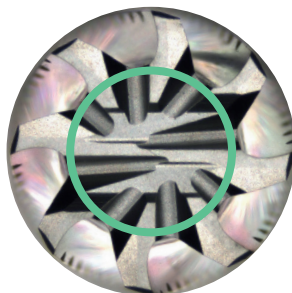

OptiMill®-Composite-Speed

- Bigger core diameter
- New dimensions with adjusted cutting length in accordance with DIN6527

### MAPAL coating

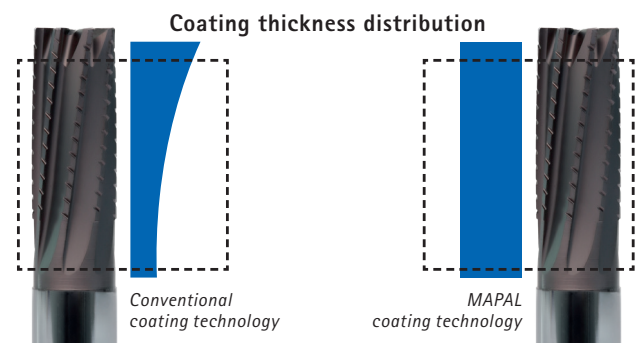

- Optimized distribution of coating thickness
- Increased diamond coating for maximum tool life

## WIDE RANGE OF APPLICATIONS

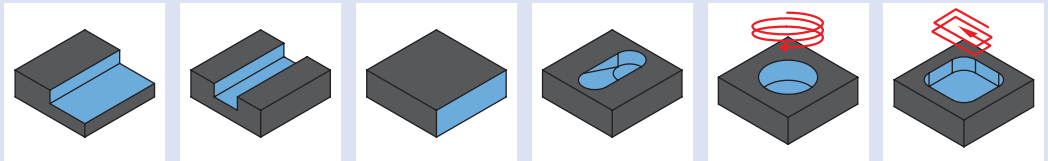

## QUALITY

### Excellent cutting quality

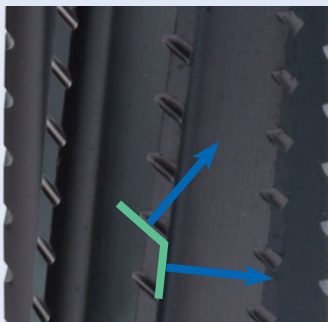

- Special cutting-edge serration causes double compression
- Reliable separation of fibre fraying on workpiece edges
- Extremely sharp cutting edges

## WEAR AND TEAR

### Maximum tool life

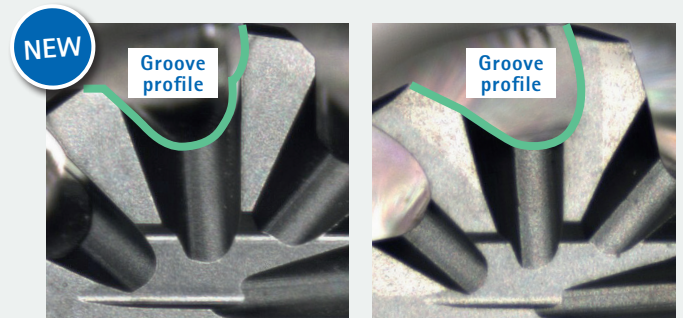

OptiMill®-Composite-Speed-Plus

OptiMill®-Composite-Speed

- High cutting stability due to reinforced cutting wedge
- Optimised groove profile and double point thinning for better dust removal
- Improved coating adhesion properties

# OptiMill®-Composite-Speed-Plus

Uncoated



**Performance Line:**  
High-performance tools, broad field of application, greater productivity in series manufacturing

## NEW TOOL DESIGN FOR MORE PRODUCTIVITY

Compared to previous router tools, the OptiMill-Composite-Speed-Plus markedly improves quiet running and increases tool life.

**NEW**



OptiMill-Composite MT | Router tools

Increased productivity



OptiMill-Composite-Speed-Plus, uncoated

**+30 %**

### COMPARISON TOOL LIFE [m]

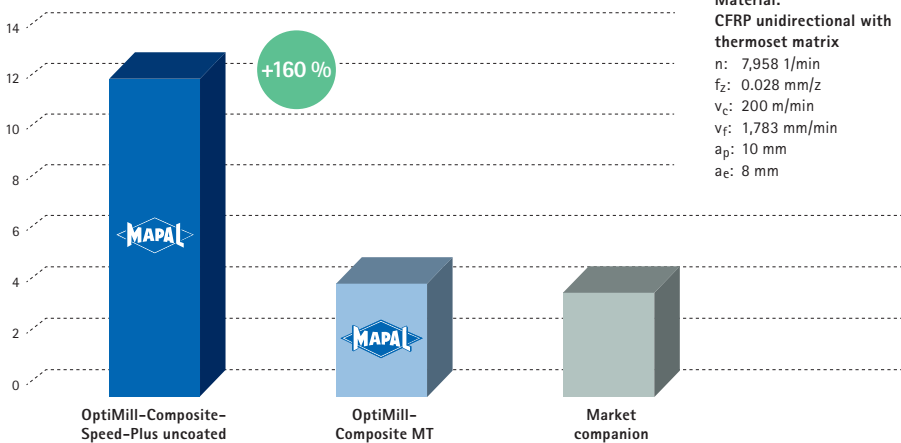

**Material:**  
CFRP unidirectional with thermoset matrix  
n: 7,958 1/min  
f<sub>z</sub>: 0.028 mm/z  
v<sub>c</sub>: 200 m/min  
v<sub>f</sub>: 1,783 mm/min  
a<sub>p</sub>: 10 mm  
a<sub>e</sub>: 8 mm

### AT A GLANCE

- First choice in unfavourable process conditions
- Extremely sharp cutting edge for optimum cutting quality
- Ideal for workpiece material with low abrasiveness

# OptiMill®-Composite-Speed-Plus

Coated



**Expert Line:**  
Specialist tools for selected applications,  
maximum precision and productivity

## FURTHER DEVELOPMENT REDUCES AXIAL FORCES

Axial forces for the OptiMill-Composite-Speed-Plus are reduced by 40 percent compared to the OptiMill-Composite-Speed. A neutral series is not required for this reason.

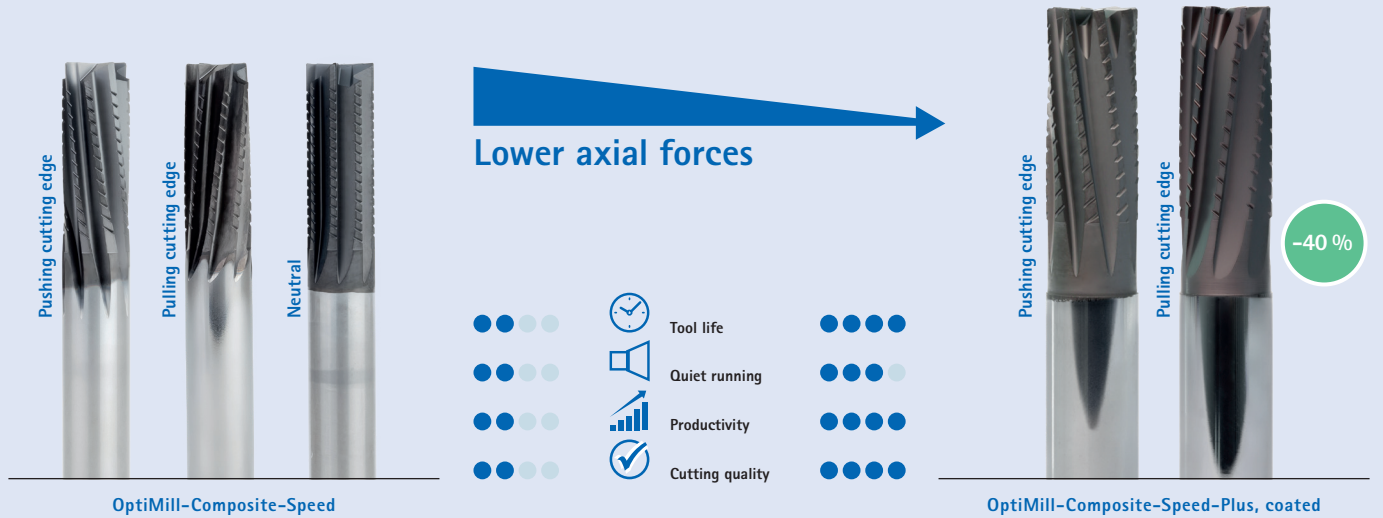

## COMPARISON TOOL LIFE [m]

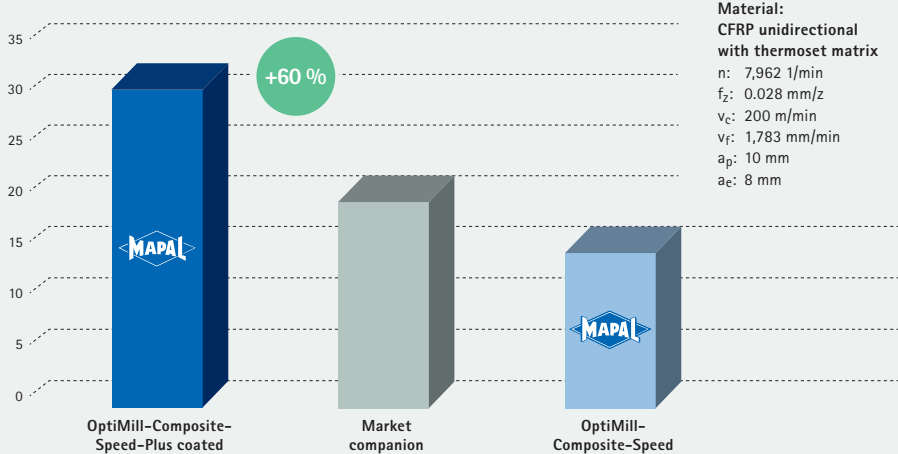

## AT A GLANCE

- First choice in good process conditions
- Even MAPAL uniform diamond coating thickness distribution for increased process reliability
- Increased coating thickness for maximum tool life
- Highest productivity

# OptiMill®-Composite-Speed-Plus

Shoulder milling cutter, uncoated, design with pulling cutting edge  
SCM982

**Design:**

Diameter of milling cutter: 4.00 - 20.00 mm  
Cutting material: HU610  
Number of cutting edges: 8  
Helix angle: 8°  
Special features: Without coating, extremely sharp cutting edge

**Application:**

Roughing and finishing of CFRP in one machining step. Pulling cutting edge for better removal of the chips/dust (e.g. on milling pockets and slots). Particularly suitable for difficult to machine surface layers (e.g. UD or copper mesh) to prevent delamination on the lower edge of the part.

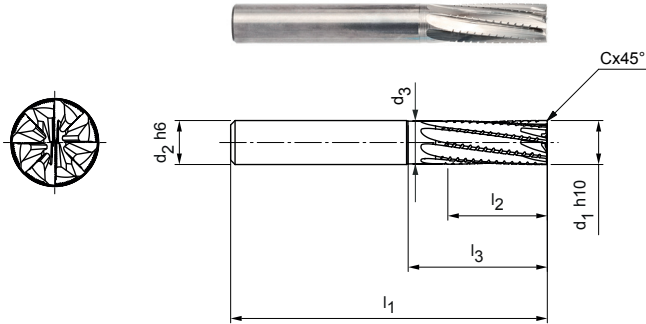

N	1.1	1.2	1.3	1.4	2.1	2.2	2.3	3.1	3.2	4.1	4.2	4.3	C	1.1	1.2	1.3	2.1	3.1	4.1	4.2	5.1	5.2	5.3
---	-----	-----	-----	-----	-----	-----	-----	-----	-----	-----	-----	-----	---	-----	-----	-----	-----	-----	-----	-----	-----	-----	-----

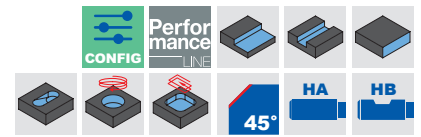

**Preferred series available from stock**

Dimensions							z	Specification	Order no.
d <sub>1</sub> h10	d <sub>2</sub> h6	d <sub>3</sub>	l <sub>1</sub>	l <sub>2</sub>	l <sub>3</sub>	Cx45°			
4,00	6	3,90	57	11	-	0,08	8	SCM982-0400Z08R-F0008HA-HU610	31237353
5,00	6	4,90	57	13	-	0,10	8	SCM982-0500Z08R-F0010HA-HU610	31237354
6,00	6	5,80	57	13	19	0,12	8	SCM982-0600Z08R-F0012HA-HU610	31237355
6,00	6	5,80	65	21	27	0,12	8	SCM982-0600Z08R-F0012HA-HU610	31237356
8,00	8	7,80	63	19	25	0,16	8	SCM982-0800Z08R-F0016HA-HU610	31237357
8,00	8	7,80	70	22	32	0,16	8	SCM982-0800Z08R-F0016HA-HU610	31237358
10,00	10	9,70	72	22	30	0,20	8	SCM982-1000Z08R-F0020HA-HU610	31237359
12,00	12	11,60	83	26	36	0,24	8	SCM982-1200Z08R-F0024HA-HU610	31237380
16,00	16	15,50	92	32	42	0,32	8	SCM982-1600Z08R-F0032HA-HU610	31237381

**Available on request**

20,00	20	19,40	104	38	52	0,40	8	SCM982-2000Z08R-F0040HA-HU610	31237382
-------	----	-------	-----	----	----	------	---	-------------------------------	----------

**Configurable features**



**Shank form:**  
Shank form: HB



**Specification:**  
SCM982-0400Z08R-F0008[shank form]-HU610

**Example:**

SCM982-0400Z08R-F0008**HB**-HU610

Shank form HB

Dimensions in mm.

For cutting data recommendation, see pages 10/11.

Special designs and other coatings available upon request.

# OptiMill®-Composite-Speed-Plus

Shoulder milling cutter, uncoated, design with pushing cutting edge  
SCM992

**Design:**

Diameter of milling cutter: 4.00 - 20.00 mm  
Cutting material: HU610  
Number of cutting edges: 8  
Helix angle: -8°  
Special features: Without coating, extremely sharp cutting edge

**Application:**

Roughing and finishing of CFRP in one machining step. Pushing cutting edge, where the material is pressed onto the base (e.g. very suitable for vacuum clamping). Particularly suitable for difficult to machine surface layers (e.g. UD or copper mesh) to prevent delamination on the upper edge of the part.

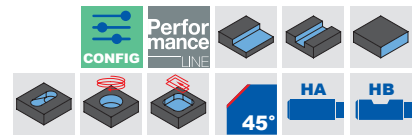
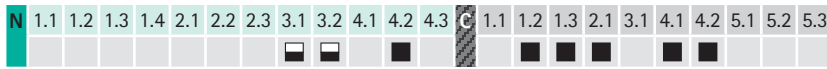
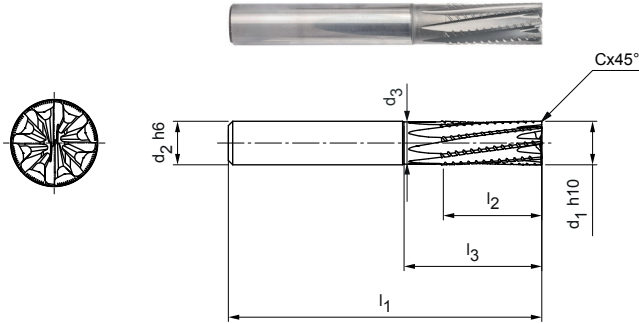

**Preferred series available from stock**

Dimensions							z	Specification	Order no.
d <sub>1</sub> h10	d <sub>2</sub> h6	d <sub>3</sub>	l <sub>1</sub>	l <sub>2</sub>	l <sub>3</sub>	Cx45°			
4,00	6	3,90	57	11	-	0,08	8	SCM992-0400Z08R-F0008HA-HU610	31242585
5,00	6	4,90	57	13	-	0,10	8	SCM992-0500Z08R-F0010HA-HU610	31242586
6,00	6	5,80	57	13	19	0,12	8	SCM992-0600Z08R-F0012HA-HU610	31242587
6,00	6	5,80	65	21	27	0,12	8	SCM992-0600Z08R-F0012HA-HU610	31242588
8,00	8	7,80	63	19	25	0,16	8	SCM992-0800Z08R-F0016HA-HU610	31242589
8,00	8	7,80	70	22	32	0,16	8	SCM992-0800Z08R-F0016HA-HU610	31242590
10,00	10	9,70	72	22	30	0,20	8	SCM992-1000Z08R-F0020HA-HU610	31242591
12,00	12	11,60	83	26	36	0,24	8	SCM992-1200Z08R-F0024HA-HU610	31242592
16,00	16	15,50	92	32	42	0,32	8	SCM992-1600Z08R-F0032HA-HU610	31242593

**Available on request**

20,00	20	19,40	104	38	52	0,40	8	SCM992-2000Z08R-F0040HA-HU610	31242594
-------	----	-------	-----	----	----	------	---	-------------------------------	----------

**Configurable features**



**Shank form:**  
Shank form: HB



**Specification:**  
SCM992-0400Z08R-F0008[shank form]-HU610

**Example:**

SCM992-0400Z08R-F0008**HB**-HU610

Shank form HB

Dimensions in mm.

For cutting data recommendation, see pages 10/11.

Special designs and other coatings available upon request.

# OptiMill®-Composite-Speed-Plus

Shoulder milling cutter, coated, design with pulling cutting edge  
SCM980, follow-up product of SCM460

**Design:**

Diameter of milling cutter: 4.00 - 20.00 mm  
Cutting material: HC633  
Number of cutting edges: 8  
Helix angle: 8°  
Special features: Diamond coating

**Application:**

Roughing and finishing of CFRP in one machining step. Pulling cutting edge for better removal of the chips/dust (e.g. on milling pockets and slots). Particularly suitable for difficult to machine surface layers (e.g. UD or copper mesh) to prevent delamination on the lower edge of the part.

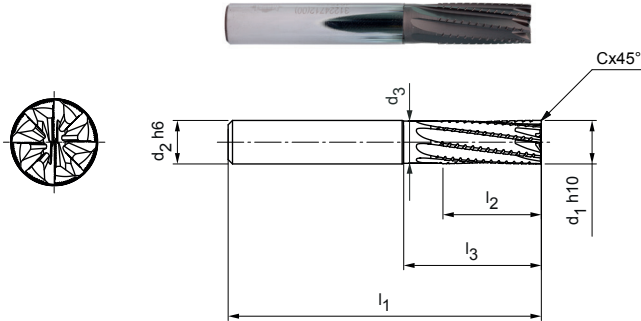

N	1.1	1.2	1.3	1.4	2.1	2.2	2.3	3.1	3.2	4.1	4.2	4.3	C	1.1	1.2	1.3	2.1	3.1	4.1	4.2	5.1	5.2	5.3
---	-----	-----	-----	-----	-----	-----	-----	-----	-----	-----	-----	-----	---	-----	-----	-----	-----	-----	-----	-----	-----	-----	-----

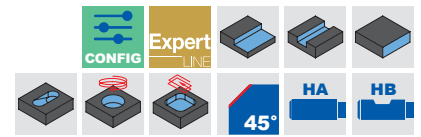

**Preferred series available from stock**

Dimensions							z	Specification	Order no.
d <sub>1</sub> h10	d <sub>2</sub> h6	d <sub>3</sub>	l <sub>1</sub>	l <sub>2</sub>	l <sub>3</sub>	Cx45°			
4,00	6	3,90	57	11	-	0,08	8	SCM980-0400Z08R-F0008HA-HC633	31223245
5,00	6	4,90	57	13	-	0,10	8	SCM980-0500Z08R-F0010HA-HC633	31223246
6,00	6	5,80	57	13	19	0,12	8	SCM980-0600Z08R-F0012HA-HC633	31223247
6,00	6	5,80	65	21	27	0,12	8	SCM980-0600Z08R-F0012HA-HC633	31223248
8,00	8	7,80	63	19	25	0,16	8	SCM980-0800Z08R-F0016HA-HC633	31223249
8,00	8	7,80	70	22	32	0,16	8	SCM980-0800Z08R-F0016HA-HC633	31223260
10,00	10	9,70	72	22	30	0,20	8	SCM980-1000Z08R-F0020HA-HC633	31223261
12,00	12	11,60	83	26	36	0,24	8	SCM980-1200Z08R-F0024HA-HC633	31223262
16,00	16	15,50	92	32	42	0,32	8	SCM980-1600Z08R-F0032HA-HC633	31223263

**Available on request**

20,00	20	19,40	104	38	52	0,40	8	SCM980-2000Z08R-F0040HA-HC633	31223264
-------	----	-------	-----	----	----	------	---	-------------------------------	----------

**Configurable features**



**Shank form:**  
Shank form: HB



**Specification:**  
SCM980-0400Z08R-F0008[shank form]-HC633

**Example:**

SCM980-0400Z08R-F0008**HB**-HC633

Shank form HB

Dimensions in mm.

For cutting data recommendation, see pages 10/11.

Special designs and other coatings available upon request.



# OptiMill®-Composite-Speed-Plus

Shoulder milling cutter, coated, design with pushing cutting edge  
SCM990, follow-up product of SCM470

**Design:**

Diameter of milling cutter: 4.00 - 20.00 mm  
Cutting material: HC633  
Number of cutting edges: 8  
Helix angle: -8°  
Special features: Diamond coating

**Application:**

Roughing and finishing of CFRP in one machining step. Pushing cutting edge, where the material is pressed onto the base (e.g. very suitable for vacuum clamping). Particularly suitable for difficult to machine surface layers (e.g. UD or copper mesh) to prevent delamination on the upper edge of the part.

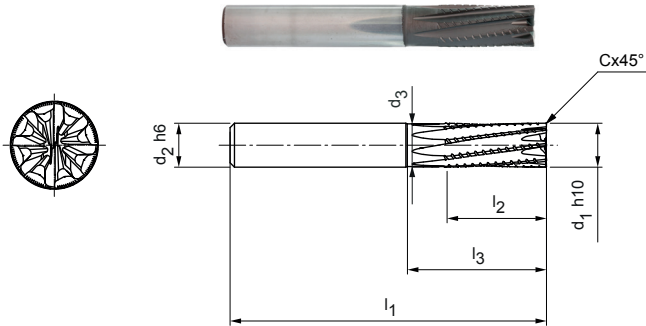

N	1.1	1.2	1.3	1.4	2.1	2.2	2.3	3.1	3.2	4.1	4.2	4.3	C	1.1	1.2	1.3	2.1	3.1	4.1	4.2	5.1	5.2	5.3	

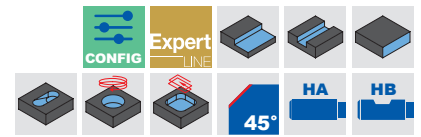

**Preferred series available from stock**

Dimensions							z	Specification	Order no.
d1 h10	d2 h6	d3	l1	l2	l3	Cx45°			
4,00	6	3,90	57	11	-	0,08	8	SCM990-0400Z08R-F0008HA-HC633	31223265
5,00	6	4,90	57	13	-	0,10	8	SCM990-0500Z08R-F0010HA-HC633	31223266
6,00	6	5,80	57	13	19	0,12	8	SCM990-0600Z08R-F0012HA-HC633	31223267
6,00	6	5,80	65	21	27	0,12	8	SCM990-0600Z08R-F0012HA-HC633	31223268
8,00	8	7,80	63	19	25	0,16	8	SCM990-0800Z08R-F0016HA-HC633	31223269
8,00	8	7,80	70	22	32	0,16	8	SCM990-0800Z08R-F0016HA-HC633	31223270
10,00	10	9,70	72	22	30	0,20	8	SCM990-1000Z08R-F0020HA-HC633	31223271
12,00	12	11,60	83	26	36	0,24	8	SCM990-1200Z08R-F0024HA-HC633	31223272
16,00	16	15,50	92	32	42	0,32	8	SCM990-1600Z08R-F0032HA-HC633	31223273

**Available on request**

20,00	20	19,40	104	38	52	0,40	8	SCM990-2000Z08R-F0040HA-HC633	31223274
-------	----	-------	-----	----	----	------	---	-------------------------------	----------

**Configurable features**

**Shank form:**  
Shank form: HB

**Specification:**  
SCM990-0400Z08R-F0008[shank form]-HC633

**Example:**

SCM990-0400Z08R-F0008**HB**-HC633

Shank form HB

Dimensions in mm.

For cutting data recommendation, see pages 10/11.

Special designs and other coatings available upon request.

# Cutting data recommendations for shoulder milling cutters

Feed and cutting speed

Groove milling

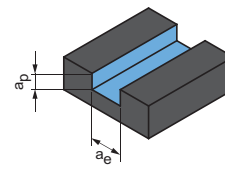

$$a_p = 1 \times D$$

$$a_e = 1 \times D$$

## OptiMill-Composite-Speed-Plus, uncoated | SCM982, 992

MMG*	Workpiece material	Strength/hardness [N/mm <sup>2</sup> ] [HRC]	Cooling			v <sub>c</sub> [m/min]	f <sub>z</sub> [mm]							
			MQL/Air	Dry	KSS		Diameter of milling cutter [mm]							
							4.00	6.00	8.00	10.00	12.00	16.00	20.00	
N N4	N4.1	Plastic, thermoplastics	✓	✓	✓	125								
	N4.2	Plastic, duroplastics	✓	✓	✓		0.020	0.029	0.038	0.045	0.052	0.063	0.072	
	N4.3	Plastic, foam materials	✓	✓										
C C1 C2 C4	C1.1	Plastic range, reinforced with aramid fibre (AFK)	✓	✓	✓	120								
	C1.2	Plastic range (duroplastic), CFK/GFK	✓	✓	✓		0.021	0.026	0.031	0.035	0.038	0.042	0.043	
	C1.3	Plastic range (thermoplastic), CFK/GFK	✓	✓	✓		80	0.021	0.026	0.031	0.035	0.038	0.042	0.043
	C2.1	Carbon range, reinforced with carbon fibre (CFC)	✓	✓	✓	120	0.018	0.023	0.027	0.031	0.033	0.037	0.038	
	C4.1	Sandwich construction, honeycomb core (Honeycomb)	✓	✓		165	0.012	0.015	0.017	0.019	0.021	0.023	0.024	
	C4.2	Sandwich construction, foam core	✓	✓		125	0.019	0.024	0.028	0.032	0.035	0.039	0.041	

## OptiMill-Composite-Speed-Plus, coated | SCM980, 990

MMG*	Workpiece material	Strength/hardness [N/mm <sup>2</sup> ] [HRC]	Cooling			v <sub>c</sub> [m/min]	f <sub>z</sub> [mm]							
			MQL/Air	Dry	KSS		Diameter of milling cutter [mm]							
							4.00	6.00	8.00	10.00	12.00	16.00	20.00	
C C1 C2 C4	C1.1	Plastic range, reinforced with aramid fibre (AFK)	✓	✓	✓	145								
	C1.2	Plastic range (duroplastic), CFK/GFK	✓	✓	✓		0.021	0.026	0.031	0.035	0.038	0.042	0.043	
	C1.3	Plastic range (thermoplastic), CFK/GFK	✓	✓	✓		100	0.021	0.026	0.031	0.035	0.038	0.042	0.043
	C2.1	Carbon range, reinforced with carbon fibre (CFC)	✓	✓	✓	145	0.018	0.023	0.027	0.031	0.033	0.037	0.038	
	C4.1	Sandwich construction, honeycomb core (Honeycomb)	✓	✓		195	0.012	0.015	0.017	0.019	0.021	0.023	0.024	
	C4.2	Sandwich construction, foam core	✓	✓		150	0.019	0.024	0.028	0.032	0.035	0.039	0.041	

**Roughing**

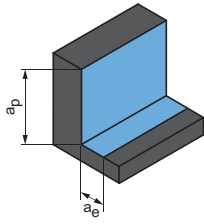

$$a_p = 1.5 \times D$$

$$a_e = 0.25 \times D$$

**Finishing**

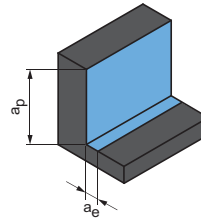

$$a_p = 1.5 \times D$$

$$a_e = 0.1 \times D$$

	$v_c$ [m/min]	$f_z$ [mm]							$v_c$ [m/min]	$f_z$ [mm]						
		Diameter of milling cutter [mm]								Diameter of milling cutter [mm]						
		4.00	6.00	8.00	10.00	12.00	16.00	20.00		4.00	6.00	8.00	10.00	12.00	16.00	20.00
	<b>190</b>	0.029	0.041	0.053	0.063	0.072	0.089	0.101	<b>230</b>	0.040	0.057	0.073	0.088	0.101	0.123	0.141
	<b>200</b>	0.021	0.026	0.031	0.035	0.038	0.042	0.043	<b>295</b>	0.021	0.026	0.031	0.035	0.038	0.042	0.043
	<b>135</b>	0.021	0.026	0.031	0.035	0.038	0.042	0.043	<b>195</b>	0.021	0.026	0.031	0.035	0.038	0.042	0.043
	<b>200</b>	0.018	0.023	0.027	0.031	0.033	0.037	0.038	<b>295</b>	0.018	0.023	0.027	0.031	0.033	0.037	0.038
	<b>270</b>	0.012	0.015	0.017	0.019	0.021	0.023	0.024	<b>395</b>	0.012	0.015	0.017	0.019	0.021	0.023	0.024
	<b>200</b>	0.019	0.024	0.028	0.032	0.035	0.039	0.041	<b>300</b>	0.019	0.024	0.028	0.032	0.035	0.039	0.041

	$v_c$ [m/min]	$f_z$ [mm]							$v_c$ [m/min]	$f_z$ [mm]						
		Diameter of milling cutter [mm]								Diameter of milling cutter [mm]						
		4.00	6.00	8.00	10.00	12.00	16.00	20.00		4.00	6.00	8.00	10.00	12.00	16.00	20.00
	<b>240</b>	0.021	0.026	0.031	0.035	0.038	0.042	0.043	<b>355</b>	0.021	0.026	0.031	0.035	0.038	0.042	0.043
	<b>160</b>	0.021	0.026	0.031	0.035	0.038	0.042	0.043	<b>235</b>	0.021	0.026	0.031	0.035	0.038	0.042	0.043
	<b>240</b>	0.018	0.023	0.027	0.031	0.033	0.037	0.038	<b>355</b>	0.018	0.023	0.027	0.031	0.033	0.037	0.038
	<b>325</b>	0.012	0.015	0.017	0.019	0.021	0.023	0.024	<b>480</b>	0.012	0.015	0.017	0.019	0.021	0.023	0.024
	<b>245</b>	0.019	0.024	0.028	0.032	0.035	0.039	0.041	<b>360</b>	0.019	0.024	0.028	0.032	0.035	0.039	0.041

The specified machining values are guide values.  
The optimum data for the respective machining task should be determined during the test or machining.



Discover tool and service solutions now that give you a lead:

## BORE MACHINING

REAMING | FINE BORING

DRILLING FROM SOLID | BORING | COUNTERSINKING

MILLING

CLAMPING

TURNING

ACTUATING

SETTING | MEASURING | DISPENSING

SERVICES

[www.mapal.com](http://www.mapal.com)