

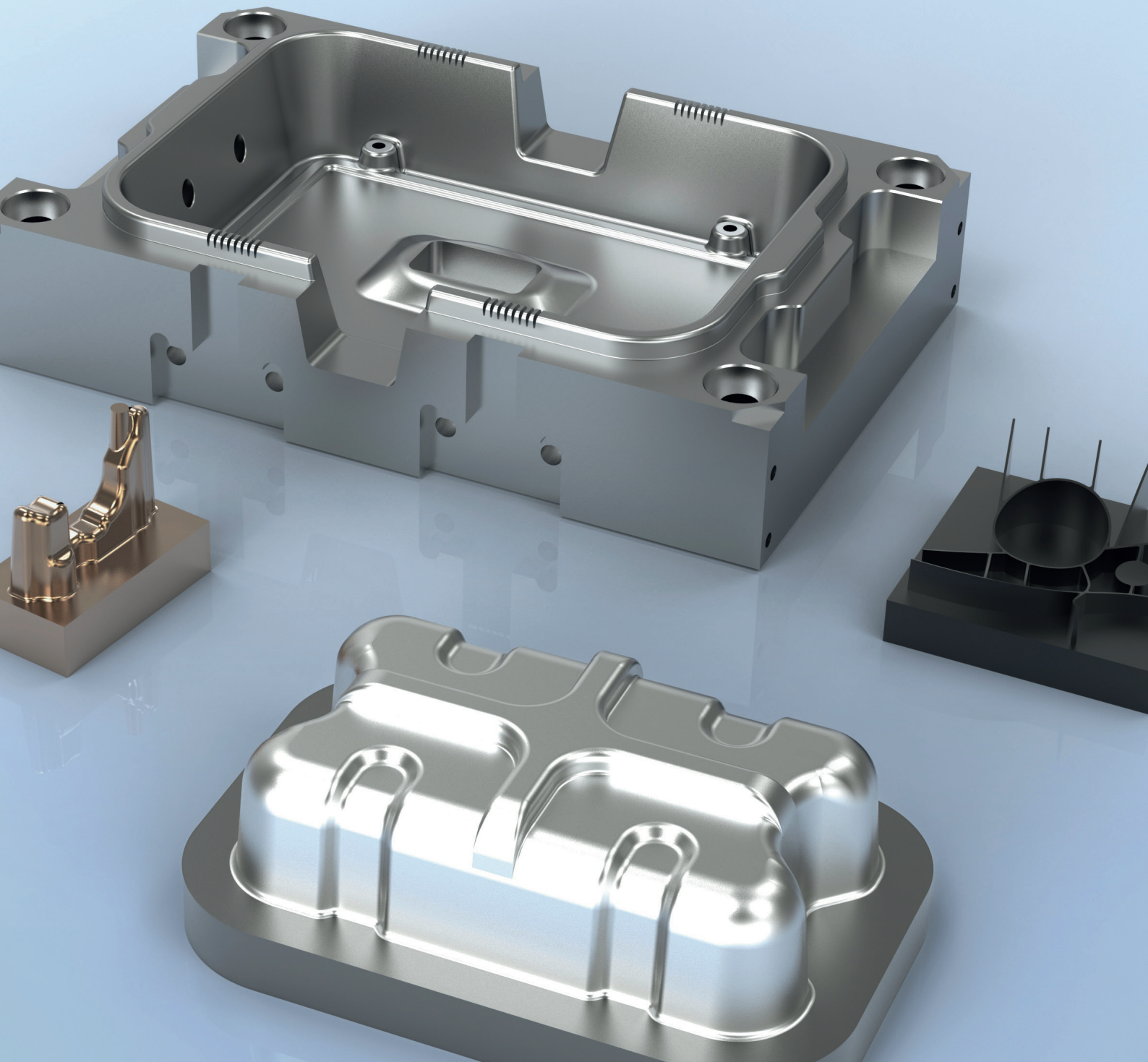

Your technology partner for cost-effective machining

DIE & MOULD



Technology partner and complete supplier in the die & mould sector

Apart from tools and chucks, MAPAL supplies complete processes and the path to digital manufacturing.

Die and mould makers expect high process and product expertise from their cutting tools manufacturer. This is because the tool life of the moulds to be created and the precision of the moulded parts are extremely important for competitiveness in mass production. Therefore, they require their tools to offer the highest levels of precision, a long tool life, and – above all – process reliability.

It is precisely these aspects that make MAPAL successful in sectors such as the automotive industry, machine engineering and the aerospace industry. Now the precision tool manufacturer is also offering efficient and economical solutions for the complete machining process in the die & mould sector. Versatile and precise high-performance tools and special tool holders with narrow contours and a precise radial run-out minimise polishing effort and reworking thanks to a constant surface finish in the milling process.



Machining solutions for the die & mould sector that are both innovative and reliable in terms of processing require a holistic understanding of the processes involved.



Find out more at:
die-mould.mapal.com

Why use MAPAL?

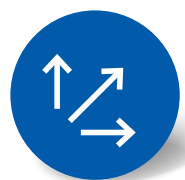

All from a single source

At MAPAL, customers can get everything they need from a single source and take advantage of our specialist knowledge of tooling and processing.



Partnership

The basis of everything we do at MAPAL is a close, open dialogue with all customers and, as a result, a long-term partnership on an equal footing.



Quality and precision

MAPAL tools stand for the highest level of quality and cost-effectiveness. Characterised by excellent dimensional accuracy and the highest level of precision.



Standard range

The range of highly capable tools available from stock ensures excellent and reliable results for all machining tasks.

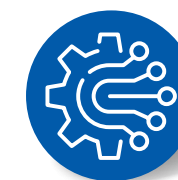

Technology leadership

In the machining of cubic components, MAPAL is the technology leader worldwide.



On the ground all over the world

Customer focus isn't just a buzzword at MAPAL – it forms an essential part of our corporate identity. On a global basis.

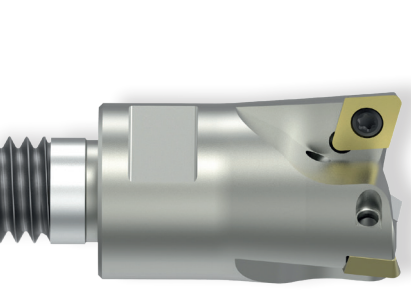

H NeoMill-3D-Finish
Finishing milling cutter

- Perfect for finishing 90° surfaces, face surfaces and contours
- Ø range: 16.00 - 42.00 mm



H NeoMill-3D-Ballnose/Torus
Ball nose and corner radius milling cutter

- One tool body with indexable insert for ball nose and corner radius milling for finishing and pre-finishing
- Ø range: 8.00 - 32.00 mm

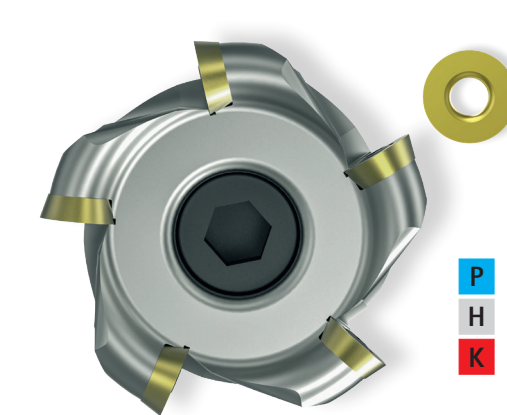

P NeoMill-ISO-360
H Milling cutter with round inserts

- Perfect for roughing and pre-finishing
- Ø range: 10.00 - 160.00 mm

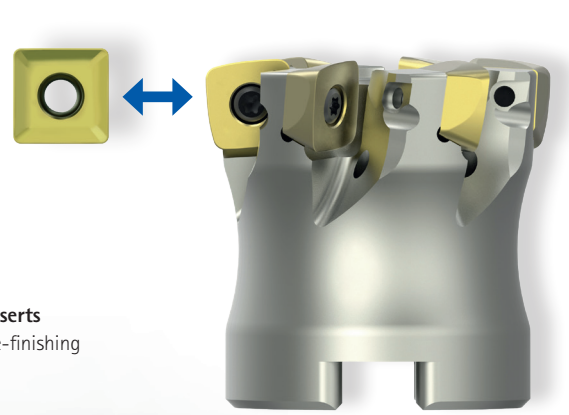

P NeoMill-2/4-HiFeed90
H High-feed/90° shoulder milling cutter

- Universal tool system to ensure maximum productivity
- Ø range: 16.00 - 200.00 mm

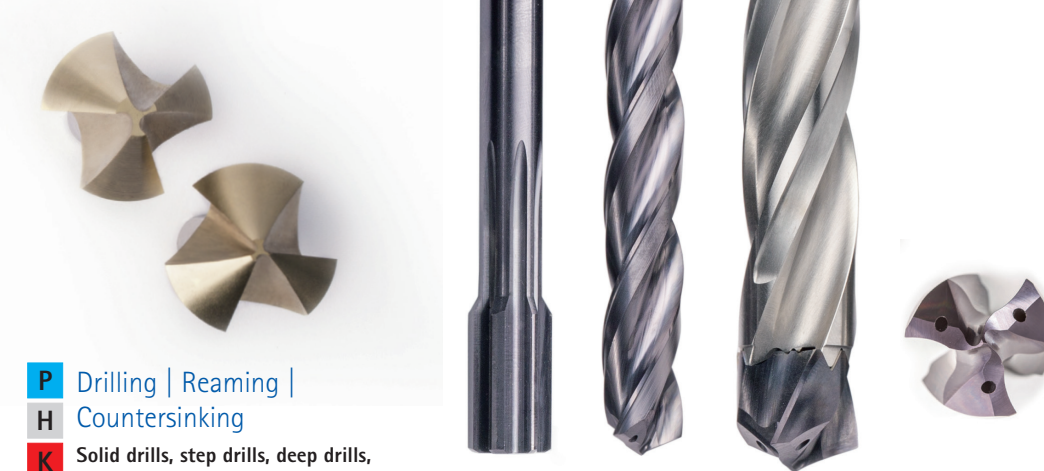

P Drilling | Reaming |
H Countersinking
K Solid drills, step drills, deep drills,
N reamers and countersinking tools



N OptiMill-Diamond
Ball nose, corner radius and shoulder milling cutter

- PCD cutting edges for a long tool life
- Ø range: 3.00 - 12.00 mm



N OptiMill-3D-Copper
Ball nose and corner radius milling cutter

- Special geometry for machining copper electrodes and tough non-ferrous alloys
- Ø range: 0.10 - 20.00 mm

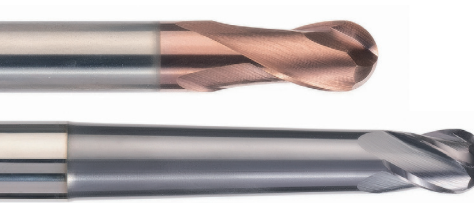

P OptiMill-3D-BN
H Ball nose milling cutter

- High-precision machining of 3D contours
- Ø range: 0.10 - 20.00 mm

P H Steel and hardened steel

Parts that become more and more complex with increasingly deep cavities as well as moulded and reinforcement ribs in plastic injection moulds and pressure die casting moulds necessitate the use of extra long tools with diameters that can be very small. Complex part geometries and various material characteristics place the highest demands on machining and tool life.

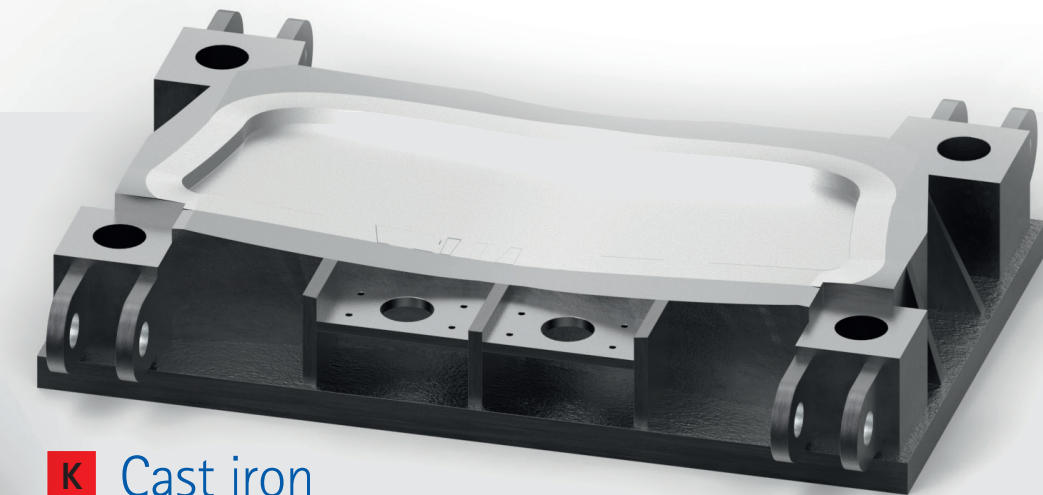
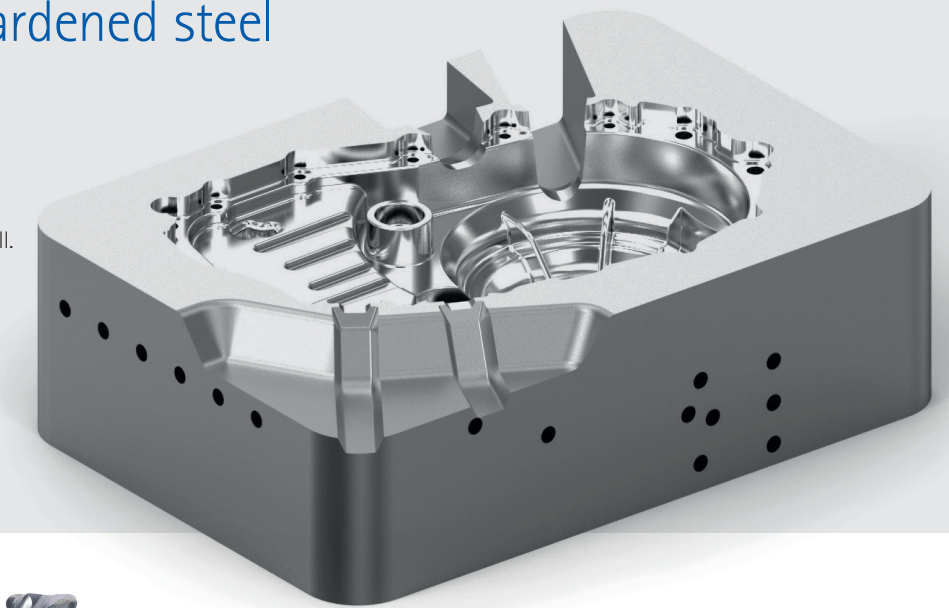

K Cast iron

For designing, engineering and constructing medium- and large-sized cold forming tools, cast iron is often used due to material properties such as compressive strength and easy machinability. The main components here are mould plates and mould inserts. Here, MAPAL has a lot of experience with milling (2D and 3D) and drilling operations (drilling, reaming, thread cutting).

N Aluminium

When it comes to pre-series or prototype moulds, it is not unusual to use materials that are easy to machine. Aluminium alloys or uriol (plastics) are often used. In these cases, solid carbide tools with positive and partly polished cutting edges, or better still, PCD-tipped tools ensure high productivity and short machining times.

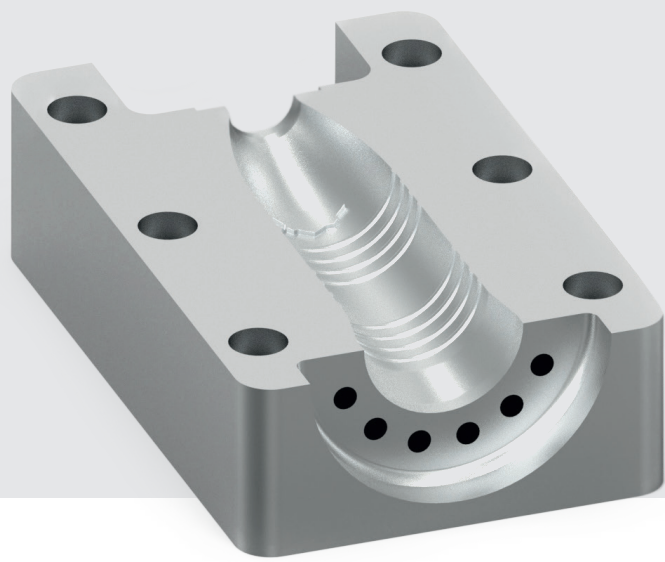

N Copper

Manufacturing of electrodes for EDM processes requires machining of copper alloys and graphite materials. The selection of the electrode material depends on the requirements of the mould to be created. Copper alloys are comparatively expensive and are generally used for finishing the electrodes, when it comes to high surface quality and shape accuracy. Solid carbide end mills with special geometries by MAPAL guarantee high-precision machining results here.



N Graphite

Graphite has a highly abrasive effect on the tool and causes strong wear on the cutting edge. The profiles to be machined tend to burst with increasing wear. Therefore, a tool with suitable geometry and optimum cutting material is required. For machining graphite, MAPAL uses diamond-coated solid carbide tools or PCD-tipped tools.

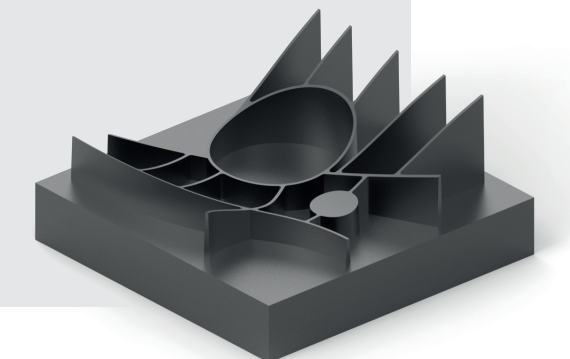

P OptiMill-3D-CR
H Corner radius milling cutter

- Milling with a very precise corner radius
- Ø range: 0.10 - 20.00 mm



P OptiMill
H Shoulder milling cutter

- Ideal for roughing, finishing, trochoidal milling and milling pockets
- Ø range: 2.00 - 12.00 mm



P OptiMill-3D-CS
H Shoulder radius milling cutter

- Finishing of complex free-form surfaces and complicated workpiece geometries
- Ø range: 2.00 - 12.00 mm



P OptiMill-3D-HF
H High-feed milling cutter

- Ideal for high-feed machining with a high material removal rate and high process reliability
- Ø range: 2.00 - 16.00 mm



Clamping
Milling chuck

- For high-performance milling operations

Hydraulic chuck

- Reliable clamping even at high process temperatures

Shrink chuck

- Extra long designs available



N OptiMill-3D-Alu
Ball nose and corner radius milling cutter

- High-precision machining of 3D contours
- Ø range: 1.00 - 20.00 mm



N OptiMill-Graphite-MT
Ball nose and shoulder milling cutter

- Multi-tooth milling cutter for roughing graphite electrodes with high removal rates
- Ø range: 3.00 - 16.00 mm



N OptiMill-3D-Graphite
Ball nose and corner radius milling cutter

- Suitable for machining of graphite electrodes
- Different designs depending on the machining situation
- Ø range: 0.20 - 12.00 mm

ALL FROM A SINGLE SOURCE
Due to the high specialisation in the die & mould sector and the significantly increasing demand for technology and management solutions, the focus is no longer only on tool solutions when selecting the right machining partner. Machining strategies, machine tools, workpiece clamping systems, CAD-CAM systems and solutions for tool management are part of the machining process and are decisive for efficient and economical manufacturing. Therefore, as a technology partner, MAPAL offers everything from a single source and covers all facets of the overall process.

Planning and purchasing



Optimised purchasing management is important for a clear organisation of the tool stock.

Tool logistics



Cost-effectiveness even in the periphery of machining: Intelligent dispensing systems significantly reduce non-productive times.

Engineering



The machining specialists provide support with process engineering, e.g. in the form of CAM simulations, general advice and the development of economic machining strategies.

Measuring and setting



Reliable setting and measuring devices are convincing due to their accuracy and user-friendly operation when setting the tools.

Tools and clamping technology

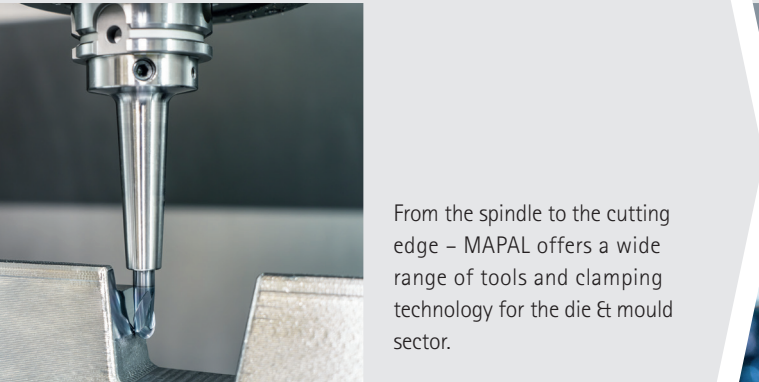

From the spindle to the cutting edge – MAPAL offers a wide range of tools and clamping technology for the die & mould sector.

Machining



Efficient machining processes and customised machining strategies at the highest technological level.

Digitisation and automation



Quick and easy digitisation: The c-Connect Box digitally transmits measurement data from the setting fixture to the machine tool. It also monitors the machine status among other things.

Reconditioning

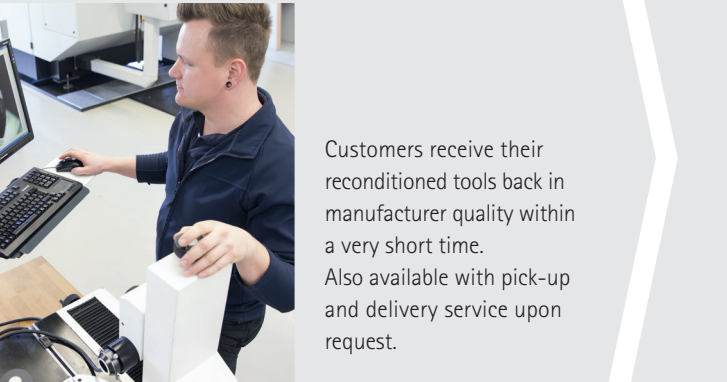

Customers receive their reconditioned tools back in manufacturer quality within a very short time. Also available with pick-up and delivery service upon request.



Discover tool and service solutions now that give you a lead:

REAMING | FINE BORING
DRILLING FROM SOLID | BORING | COUNTERSINKING
MILLING
TURNING
CLAMPING
ACTUATING
SETTING | MEASURING | DISPENSING
SERVICES

www.mapal.com