

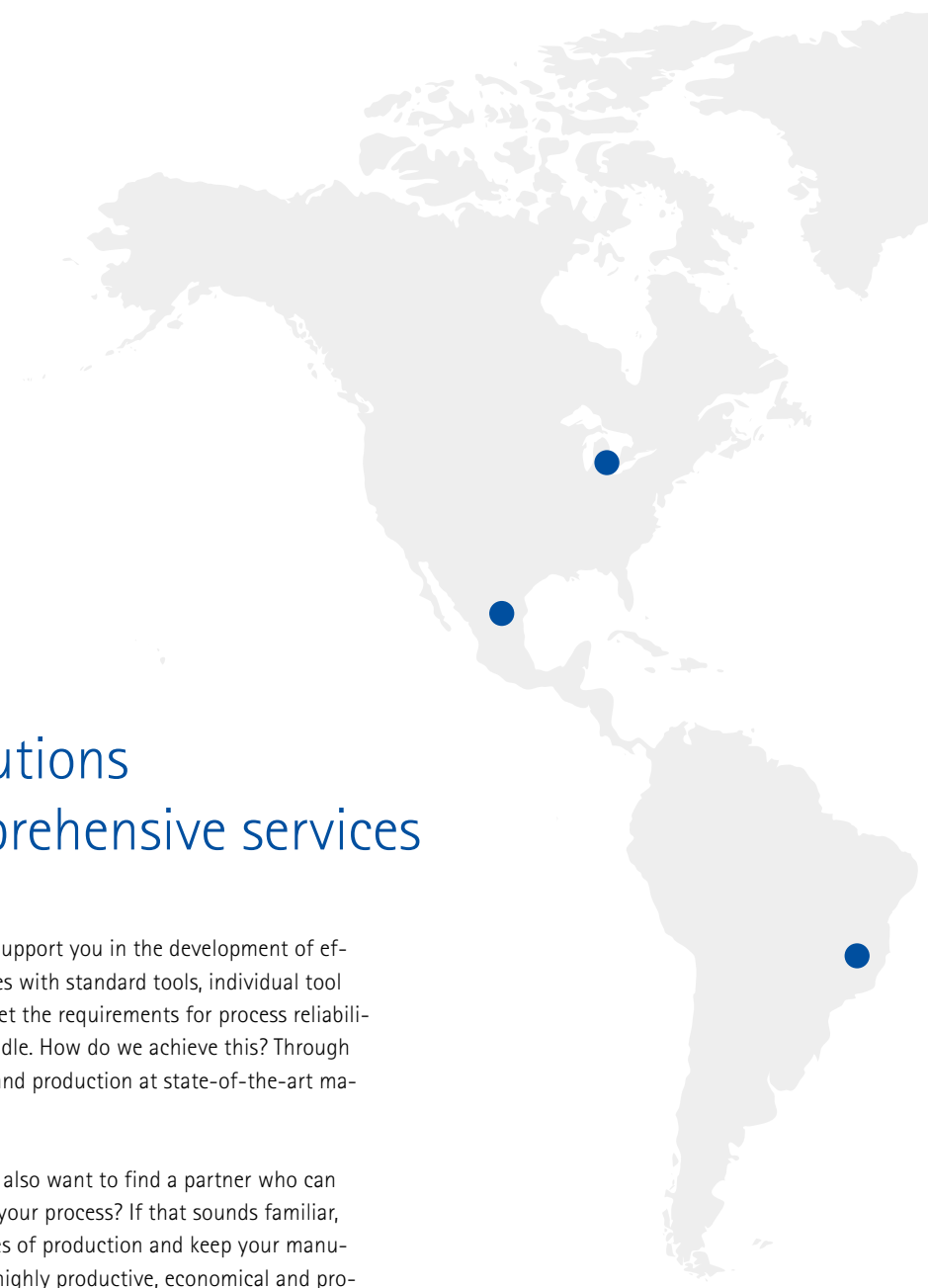

Your technology partner for cost-effective machining

BORE MACHINING



Tool and process solutions combined with comprehensive services

We see ourselves as a technology partner ready to support you in the development of efficient and resource-saving manufacturing processes with standard tools, individual tool concepts and tool detail optimisation. Our tools meet the requirements for process reliability, offer high levels of precision and are easy to handle. How do we achieve this? Through advanced development and construction methods and production at state-of-the-art manufacturing facilities.

You're looking for the perfect tool for your task but also want to find a partner who can take over and manage the entire planning stage of your process? If that sounds familiar, we're here for you. We support you during all phases of production and keep your manufacturing processes at the highest level – by being highly productive, economical and process-reliable. We also offer you complete networked solutions for all peripheral tasks related to the actual machining process.

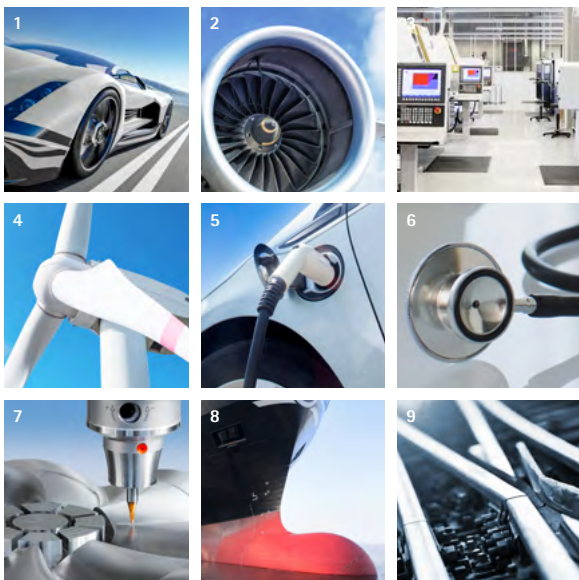

Sectors

- 1 Automotive
- 2 Aerospace
- 3 Machine engineering
- 4 Power generation
- 5 Electric mobility
- 6 Medical technology
- 7 Die & Mould sector
- 8 Shipbuilding
- 9 Rail transport



Over
5,000
 employees worldwide

No. 1
 technology leader
 for the machining
 of cubic parts



Product lines

- 1 Reaming and fine boring
- 2 Drilling from the solid, boring and countersinking
- 3 Milling
- 4 Turning
- 5 Actuating
- 6 Clamping
- 7 Setting, measuring and dispensing
- 8 Services



CONTENTS

01 Introduction

Bore machining competence	6
Overview of the range	8

02 Drilling from the solid

Product overview, series overview, selection guide, product ID code ____	12
Drilling from the solid	
Drilling from the solid using solid carbide	29
Drilling from the solid with a replaceable head system	183
Drilling from the solid using indexable inserts	239
Spot drilling	245
Stepped drilling	257
Deep drilling	267
Drill reaming	289
Custom solutions	300

03 Reaming and fine boring

Overview of the range	306
Fixed multi-bladed reamers	311
Tools with guide pads	477
Solutions for large diameters	560
Custom solutions	572

04 Countersinking

Countersinks	585
--------------------	-----

05 Boring and turning

Product overview	596
Custom solutions	598
ModulBore	613
Cartridges	643
Indexable inserts	663

06 Technical appendix

Technical appendix	737
--------------------------	-----

EXPERTISE IN BORE MACHINING

The optimum tool for every application

Based on experience gathered manufacturing custom tools for customer-specific machining solutions, MAPAL has developed an extensive standard range for bore machining.

MAPAL is one of the largest suppliers worldwide in the field of drilling with solid carbide tools. The range of solid carbide drills includes solutions for reliable and economical machining of almost every workpiece material and is augmented by modern replaceable head systems for maximum economic efficiency.

For fine bore machining, the portfolio includes fixed multi-bladed reamers as well as tools with guide pads, single-bladed reamers, the EasyAdjust system (EA system) as well as precision-ground indexable inserts and solutions for large diameters up to 400 mm.

Tools with indexable inserts take a leading role when it comes to boring. The positive indexable inserts for boring and turning are particularly economical. Tangential indexable inserts are available for the highest boring demands.



Drilling from the solid



MAPAL offers an extensive standard range of solid carbide drills for all machining tasks. In addition to two- and three-flute tools for drilling from the solid, the portfolio also includes spotting drills, step drills, deep drills, and drill reamers for drilling and reaming in one machining step. Solid drills with a replaceable head system and indexable inserts are also available. Regardless of the workpiece material, whether cast materials, non-ferrous metals, steels, modern lightweight materials or materials that are difficult to machine, MAPAL offers the right drill.

Reaming and fine boring



Reaming and fine boring are the most common methods for the fine machining of bores, yielding impressive, precise results. Depending on the complexity of the machining and the requirements for precision and surface finish, MAPAL offers the right solution.

Fixed multi-bladed reamers enable high feed rates and reduce machining time enormously. The portfolio includes monoblock reamers produced of carbide, cermet or HSS as well as HPR replaceable head reamers with high-precision HFS connection. A modular HPR range is available for machining large diameters up to 400 mm.

Tools with guide pads ensure the highest precision. Besides single-bladed reamers, the standard range includes the EasyAdjust system to set tools quickly and easily as well as precision-ground indexable inserts.

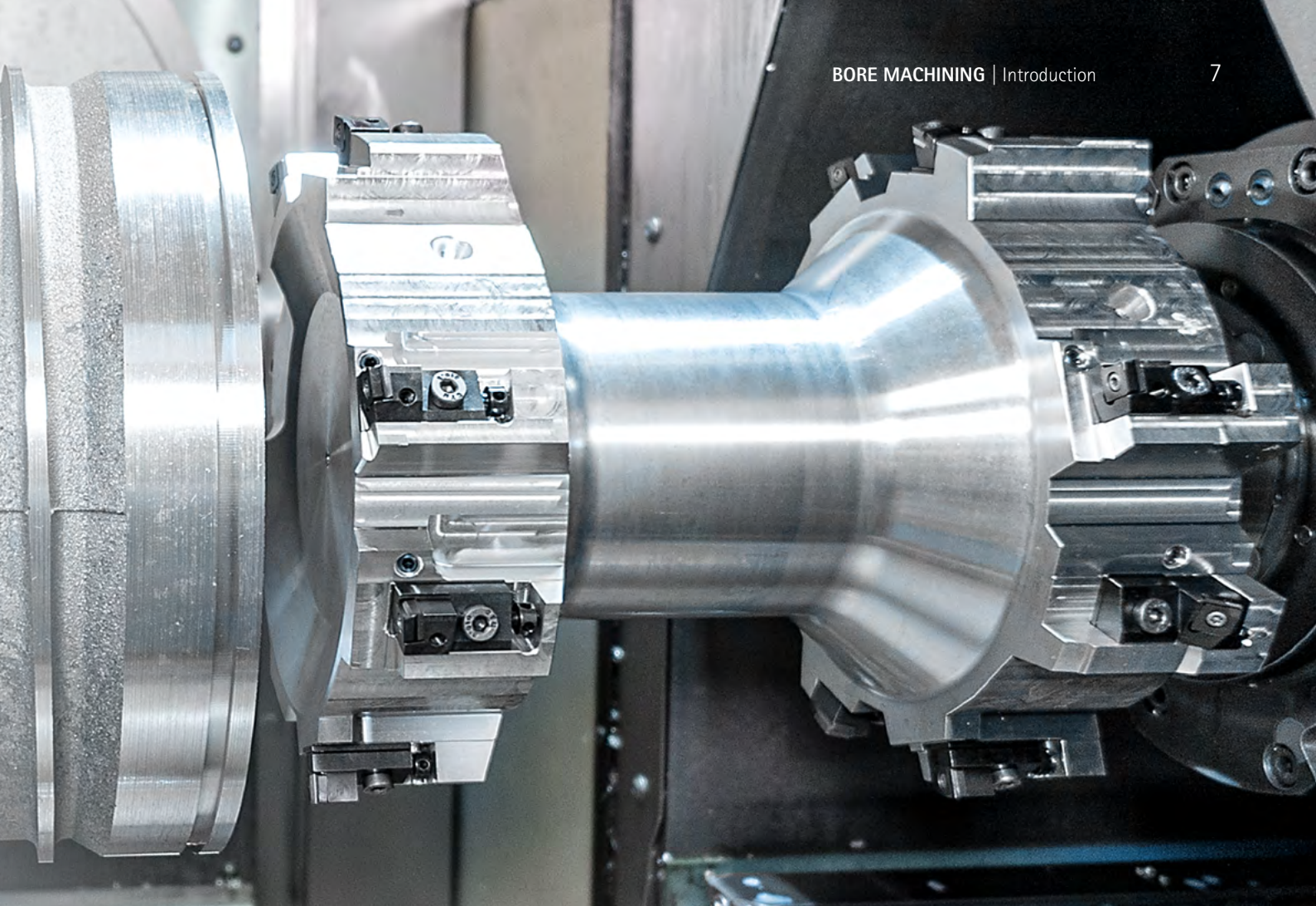

Countersinking



With extremely unequally spaced countersinks, MAPAL has established a new standard in this field. The countersinks, which are available as HSS and solid carbide variants, work with significantly reduced axial and radial forces compared to conventional countersinks. The resulting advantages are a better surface finish, long tool life, and optimum screw and rivet bore connections.

Boring and turning



MAPAL offers different concepts and tool solutions for boring and turning. They are optimised for different requirements and offer flexibility, economic efficiency and process reliability even for demanding machining operations. The portfolio includes cartridges, radial and tangential indexable inserts, individual solutions with PCD cutting edges or inserts, and the ModulBore range for boring, which is specifically adapted to the respective customer requirements.

OVERVIEW OF THE RANGE



1 | Drilling from the solid

- 1.1 Drilling from the solid using solid carbide (from page 29)
- 1.2 Drilling from the solid using a replaceable head system (from page 183)
 - Drilling from the solid using indexable inserts (from page 239)
- 1.3 Spot drilling (from page 245)
- 1.4 Stepped drilling (from page 257)
- 1.5 Deep drilling (from page 267)
- 1.6 Drill reaming (from page 289)

2 | Reaming and fine boring

- 2.1 High-performance reamer | FXR (from page 316)
- 2.2 Replaceable head reamer | HPR (from page 368)
 - Tipped high-performance reamer | MOR/MRF (from page 350)
- 2.3 Single bladed reamer (from page 478)
- 2.4 EasyAdjust system (from page 514)
- 2.5 Solutions for large diameters (from page 560)



3 | Countersinking

3.1 Countersinks (from page 586)

4 | Boring and turning

4.1 Custom solutions using PCD (from page 598)

4.2 Custom solutions using indexable inserts (from page 604)

4.3 ModulBore (from page 613)

4.4 Cartridges (from page 643)

4.5 Indexable inserts (from page 663)

DRILLING FROM THE SOLID

Optimal drills for almost all applications and workpiece materials.





PRODUCT OVERVIEW

For drilling from the solid, MAPAL offers a comprehensive standard range of solid carbide drills and replaceable head drills for almost all machining tasks. The range includes universal drills as well as tools for machining cast iron, non-ferrous metals, steels, lightweight or difficult to machine workpiece materials. Solutions for high-speed and high-feed machining with three cutting edges form part of the range.

MAPAL offers specially designed PCD-tipped drills for specific customer requirements. The solid carbide and replaceable head drill can also be individually customised. A worldwide service to re-grind tools to original quality guarantees the highest economic efficiency for all tools.







Basic Line:
Universal tools, wide range of applications, low acquisition costs







Performance Line:
High-performance tools, broad field of application, high productivity in series production

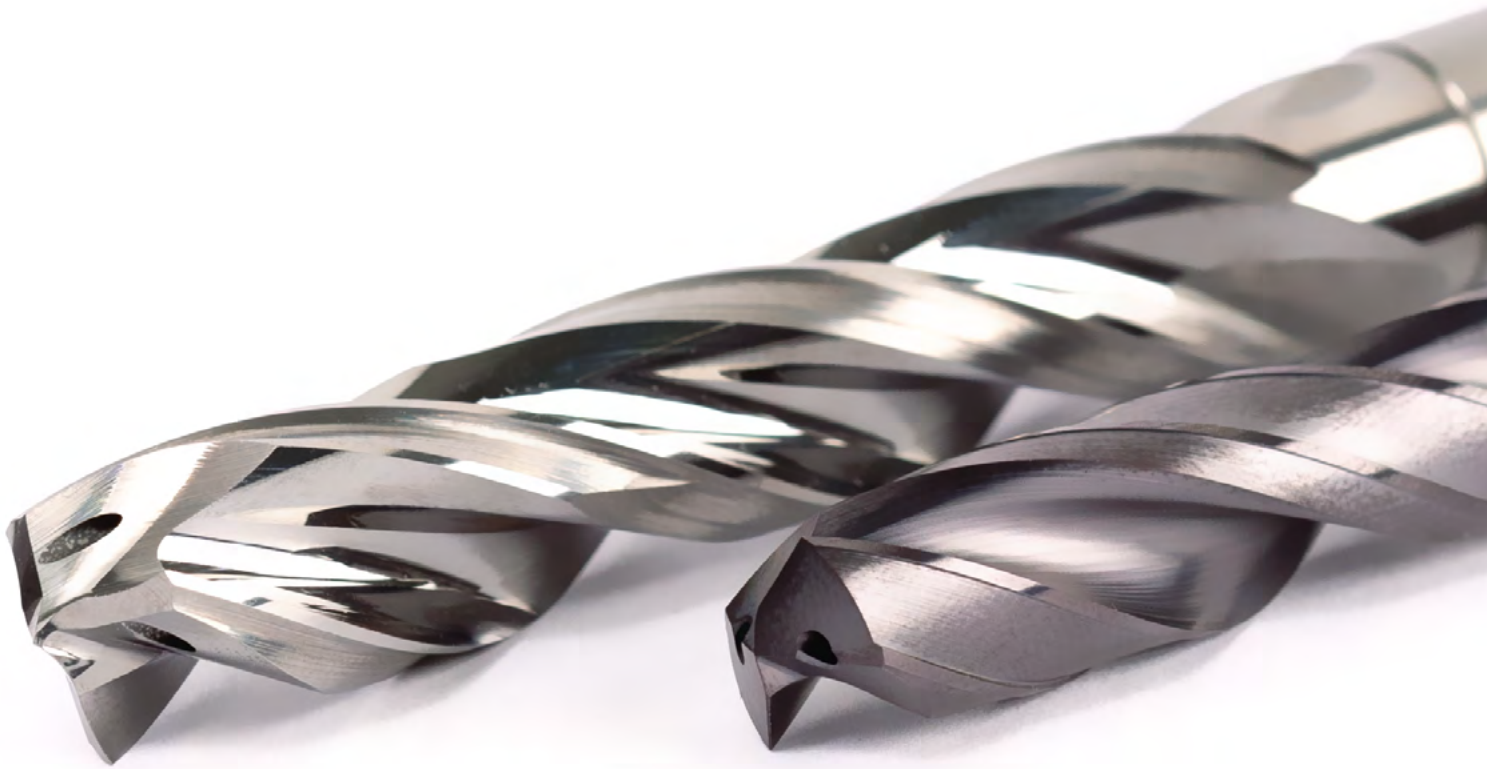

Expert Line:
Specialist tools for selected applications, maximum precision and productivity

Solid drills			Spotting drills	
				
<p>Drilling from the solid with solid carbide</p> <p>Solid carbide drills for almost all workpiece materials in three different performance classes.</p> <ul style="list-style-type: none"> - MEGA Drill: Double edged solid drills with coating and geometry matched to the respective workpiece material - Tritan-Drill: Triple-edge solid drills for maximum feed with self-centring chisel edge for difficult drilling situations - ECU-Drill: Extremely economical range with a good price-to-performance ratio <p>Ø range: 0.50 - 25.00 mm Drilling depth: 3xD 4xD 5xD 6xD 8xD 12xD</p> <p>P M K N C S H</p>	<p>Drilling from the solid with a replaceable head system</p> <p>Drilling from the solid with minimised use of carbide, maximum stability and precision.</p> <ul style="list-style-type: none"> - QTD indexable insert drill: Cost-effective system with indexable inserts that can be swapped out - TTD replaceable head drill: Double edged replaceable head drill with five different drill heads - TTD-Tritan replaceable head drill: Up to twice the feed rate of double edged replaceable head drills. High process reliability and stability even in difficult drilling situations <p>Ø range: 9.00 - 50.00 mm Drilling depth: 1xD 1.5xD 3xD 5xD</p> <p>P M K N C S H</p>	<p>Drilling from the solid using indexable inserts</p> <p>Drilling aluminium from solid with CVD-diamond-coated indexable inserts.</p> <ul style="list-style-type: none"> - CVD-diamond-coated indexable inserts with three cutting edges for highest productivity and economic efficiency - Drilling AISi1 to AISi12 from solid - With internal cooling, MQL also possible - Customer-specific solutions for: Ø 16 - 54.9 mm <p>Ø range: 16.00 - 54.90 mm Drilling depth: Up to 3xD</p> <p>N</p>	<p>Spot drilling</p> <p>Production of centring holes according to DIN.</p> <ul style="list-style-type: none"> - Tritan-Spot-Drill: Triple-edge spotting drill for demanding spot drilling situations, specially adapted to triple-edge drills - ECU-Centre-Drill: Production of DIN-compliant centring holes in rotationally symmetrical parts - CPD-Spot-Drill: Double edged centring drill with CFS connection <p>Ø range: 0.50 - 20.00 mm</p> <p>P M K S</p>	
<p>Page 29</p>	<p>Page 183</p>	<p>Page 239</p>	<p>Page 245</p>	

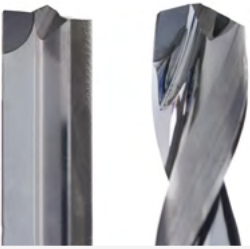

Step drills	Deep drills	Drill reamers	Special solutions
			
<p>Stepped drilling</p> <p>Production of core bores and chamfers for metric threads.</p> <ul style="list-style-type: none"> - Tritan-Step-Drill: Triple-edge step drill with self-centring chisel edge for machining threaded core bores without oscillating movement - MEGA-Step-Drill: Double edged step drill for the production of threaded core bores <p>Ø range: 2.50 - 17.50 mm</p> <p>P M</p>	<p>Deep drilling</p> <p>Process-reliable and efficient production of deep bores up to 40xD.</p> <ul style="list-style-type: none"> - MEGA-Deep-Drill: Deep drill with internal cooling for process-reliable machining of deep bores up to 40xD - MICRO-Step-Drill-Steel: Spotting drill specifically designed for the MEGA-Deep-Drill <p>Ø range: 1.00 - 16.00 mm Drilling depth:</p> <p>12xD 20xD 25xD 30xD 40xD</p> <p>P M K N</p>	<p>Drill reaming</p> <p>Drilling and reaming in one machining step.</p> <p>Tritan-Drill-Reamer:</p> <ul style="list-style-type: none"> - Most accurate solution for drill reaming - Three cutting edges and six guiding chamfers - Self-centring chisel edges for improved spot drilling - High degree of positional accuracy - Optimal roundness - With internal cooling - Tolerance versions: ±0.003 mm and H7 <p>Ø range: 3.80 - 20.05 mm Drilling depth:</p> <p>3xD 5xD</p> <p>P K N</p>	<p>Special solutions</p> <ul style="list-style-type: none"> - Application-specific special solutions in the range of solid carbide drills - PCD-tipped drills optimally designed for machining aluminium and CFRP - The portfolio ranges from the simple straight-fluted PCD-tipped drill to the twisted PCD-tipped step drills - World-leading Centre of Competence for PCD tools in Pforzheim
<p>Page 257</p>	<p>Page 267</p>	<p>Page 289</p>	<p>Page 300</p>

OVERVIEW OF SERIES

Drilling from the solid with solid carbide

MEGA DRILL

Double edged solid drills with coating and geometry matched to the respective workpiece material.



MEGA Drill

- Coating and geometry individually adapted to each workpiece material
- Wide range of applications
- Includes deep drills, step drills and micro drills for every application



Product category:



Material suitability:



Drilling depth:



Ø range: 0.50 - 25.00 mm

MEGA-Speed-Drill

- High-speed drill with two cutting edges
- Finely ground groove profile for fast chip removal
- Three guiding chamfers reduce friction and vibration



Product category:



Material suitability:



Drilling depth:



Ø range: 3.00 - 20.00 mm

MEGA-Quadro-Drill

- Four guiding chamfers for maximum bore quality, concentricity and positioning accuracy
- Optimal roundness and diameter tolerances



Product category:



Material suitability:



Drilling depth:



Ø range: 3.00 - 20.00 mm

MEGA 180° Drill

- Drilling from the solid with a flat bottom of the bore
- Low radial forces when spot drilling on inclined surfaces up to 45°



Product category:



Material suitability:



Drilling depth:



Ø range: 3.00 - 20.00 mm

TRITAN-DRILL

Triple-fluted solid drills for maximum feed with self-centring chisel edge for difficult drilling situations.



ECU DRILL

Extremely economical range with a good price-to-performance ratio.



Tritan-Drill

- Robust tool with stable cutting edges
- No oscillating movements during machining
- Optimum chip removal



Product category:



Material suitability:



Drilling depth:



ø range: 5.00 - 20.00 mm

ECU Drill

- Economical range
- Cutting material und coating specially suited to the workpiece material



Product category:



Material suitability:



Drilling depth:



ø range: 3.00 - 20.00 mm

SELECTING A DRILL

Step-by-step guide to selecting the right drill

Say you're looking for a solid drill to machine hardened steel.
This selection guide will show you how to pick the right drill step by step.

1	Application	Select the main use for your new drill.	➤		Drilling from the solid		Spot drilling
2	Design	Select your preferred tool design.	➤		Monolithic		QTS connection
3	Product category	Choose a product category.	➤	Basic Line: Universal tools, wide range of applications, low acquisition costs			
4	Material suitability	Select your workpiece according to the MAPAL machining groups (MMG). You'll find the MMG chart on the fold-out page at the end of the catalogue.	➤		Steel		Stainless steel
5	Part features	Check the demands the bore properties will place on your tool.	➤		High-feed machining		High-speed machining
			➤		Achievable bore tolerance		Achievable bore tolerance of H7
6	Design	Check that the geometric features meet your requirements.	➤	Diameter range	Number of cutting edges		
7	Product	Select the drill you need. Products of the stocked preferred series are available at short notice, while products with configurable features can be freely configured within predefined limits.	➤		Stocked preferred series		



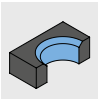

Stepped drilling

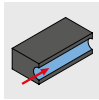

Deep drilling

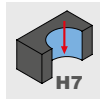

Drill reaming



TTS connection



CFS connection



With indexable insert



Performance Line:
High-performance tools, broad field of application, high productivity in series production



Expert Line:
Specialist tools for selected applications, maximum precision and productivity



Cast iron



Non-ferrous metals and plastics

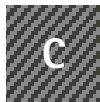

Composite materials



Super alloy and titanium



Hardened steel and cast steel

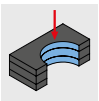

Drilling in packages

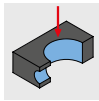

Cross bore

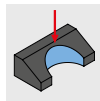

Inclined bore entrance

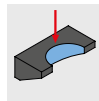

Inclined bore exit

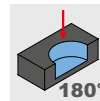

Flat bottom of the bore
180°



Tool grinding diameter tolerance



Maximum drilling depth

Number of guiding chamfers



Coolant supply



Product with configurable features

BORE MACHINING | Drilling from solid 19

Step 1: Application Step 2: Design Step 3: Product category Step 4: Material suitability Step 5: Part features Step 6: Design

Design				Product			
ø [mm]	z	ngC*		Product name	Specification		Page
3 - 25	2	2	✓	MEGA-Drill-Steel-Plus	SCD600, 601		51
2 - 20	2	2	✓	MEGA-Drill-Inox	SCD120, 121		129
2,8 - 20	2	2	✓	MEGA-Drill-Alu	SCD131		151
2,55 - 20	2	2	✓	MEGA-Drill-Hardened	SCD140		82
0,5 - 12	2	2		MEGA-Drill-Composite-IMP	SCD250		156
0,8 - 2,99	2	2	✓	MICRO-Drill-Steel	SCD371		79

6 → **7** →

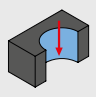

Drilling from the solid (1/2)

Design	Product category	Material suitability						Bore features							Drilling depth								
		P	M	K	N	C	S	H	HFC	HSC	W	U	V	W	180°	Tolerance	3xD	4xD	5xD	6xD	8xD	12xD	
Performance LINE		■	■	■	■	■	■	■				✓	✓			IT9	✓		✓		✓		
		■	■	■	■	■	■	■								IT9	✓		✓		✓		
		■	■	■	■	■	■	■								IT9	✓		✓		✓	✓	
		■	■	■	■	■	■	■								IT9		✓					
		■	■	■	■	■	■	■								IT9			✓				
		■	■	■	■	■	■	■								IT9			✓		✓	✓	
		■	■	■	■	■	■	■					✓			IT9			✓		✓	✓	
Expert LINE		■	■	■	■	■	■	■		✓		✓	✓	✓	✓	IT9			✓		✓	✓	
		■	■	■	■	■	■	■		✓		✓	✓	✓	✓	IT9	✓		✓		✓	✓	
		■	■	■	■	■	■	■			✓					IT9	✓		✓		✓		
		■	■	■	■	■	■	■			✓					IT9	✓		✓		✓	✓	
		■	■	■	■	■	■	■			✓					IT9			✓		✓	✓	
		■	■	■	■	■	■	■			✓					IT9			✓				
		■	■	■	■	■	■	■								IT9	✓		✓				
		■	■	■	■	■	■	■								IT9	✓		✓				
		■	■	■	■	■	■	■								IT9			✓				
		■	■	■	■	■	■	■								IT9		✓		✓			
Basic LINE		■	■	■	■	■	■	■							IT9		✓		✓				
		■	■	■	■	■	■	■							IT9	✓		✓		✓	✓		
		■	■	■	■	■	■	■							IT9			✓		✓			

■ highly suitable

■ suitable in some situations

Step 1:
Application

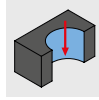

Step 2:
Design



Step 3:
Product category



Step 4:
Material suitability

















Step 5:
Part features

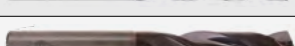
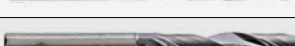

Step 6:
Design

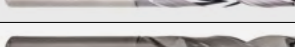
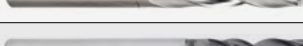
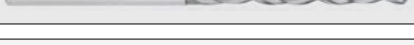
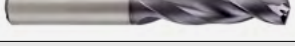
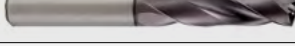

	Design				Product			
	ø [mm]	z	n _{GC} *		Product name	Specification		Page
	3 - 25	2	2	✓	MEGA-Drill-Steel-Plus	SCD600, 601		51
	2 - 20	2	2	✓	MEGA-Drill-Inox	SCD120, 121		129
	2,8 - 20	2	2	✓	MEGA-Drill-Alu	SCD131		151
	2,55 - 20	2	2		MEGA-Drill-Hardened	SCD140		82
	0,5 - 12	2	2		MEGA-Drill-Composite-MD	SCD250		156
	0,8 - 2,99	2	2	✓	MICRO-Drill-Steel	SCD371		79
	3 - 20	2	4	✓	MEGA-Quadro-Drill-Plus	SCD610, 611		70
	4 - 20	3	3	✓	Tritan-Drill-Uni-Plus	SCD631		30
	4 - 20	3	3	✓	Tritan-Drill-Steel	SCD661		85
	3 - 20	2	3	✓	MEGA-Speed-Drill-Uni	SCD221		36
	3 - 20	2	3	✓	MEGA-Speed-Drill-Steel	SCD621		95
	3 - 20	2	3	✓	MEGA-Speed-Drill-Inox	SCD411		142
	3 - 20	2	3	✓	MEGA-Speed-Drill-Iron	SCD421		150
	3 - 20	2	4	✓	MEGA-180°-Drill	SCD231		105
	3 - 20	2	4	✓	MEGA-180°-Drill-Alu	SCD241		160
	3 - 12	2	2		MEGA-Drill-Composite-UDX	SCD270, 271		158
	3 - 20	2	2	✓	ECU-Drill-Uni	SCD350, 351		42
	3 - 20	2	2	✓	ECU-Drill-Steel	SCD360, 361		111
	4,8 - 11,6	2	4	✓	ECU-G-Drill	SCD211		164

* n_{GC} = Number of guiding chamfers

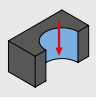







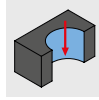







Drilling from the solid (2/2)

Design	Product category	Material suitability						Bore features							Drilling depth									
		P	M	K	N	S	H	HFC	HSC	Fluted	Double-fluted	Double-fluted	Double-fluted	Double-fluted	180°	Tolerance	1xD	1.5xD	3xD	5xD	8xD	12xD		
	Performance LINE	■		■												IT9	✓		✓	✓	✓	✓	✓	
		■		■													IT9	✓		✓	✓	✓	✓	✓
		■	■	■	■		■										IT9	✓		✓	✓	✓	✓	✓
					■												IT9	✓		✓	✓	✓	✓	✓
						■											IT9	✓		✓	✓	✓	✓	✓
	Expert LINE	■		■				✓		✓	✓	✓	✓		IT9			✓	✓	✓				
	Performance LINE	■		■						✓	✓				IT10		✓	✓	✓	✓	✓	✓	✓	
		■		■											IT10		✓	✓	✓	✓	✓	✓	✓	
		■		■											IT10		✓	✓	✓	✓	✓	✓	✓	
		■	■	■											IT10		✓	✓	✓	✓	✓	✓	✓	
					■											IT10		✓	✓	✓	✓	✓	✓	✓
						■										IT10		✓	✓	✓	✓	✓	✓	✓
	Performance LINE				■										IT9	✓	✓	✓						

■ highly suitable ■ suitable in some situations

Step 1:
ApplicationStep 2:
DesignStep 3:
Product categoryStep 4:
Material suitabilityStep 5:
Part featuresStep 6:
Design

	Design				Product			
	ø [mm]	z	n _{GC} *		Product name	Specification		Page
	12 - 45	2	4	✓	TTD Uni-Plus replaceable drill head	01P-Uni-Plus		206
	12 - 45	2	3	✓	TTD Steel replaceable drill head	04-Steel		207
	12 - 45	2	3	✓	TTD Inox replaceable drill head	02-Inox		209
	12 - 45	2	4	✓	TTD Iron replaceable drill head	05-Iron		211
	12 - 45	2	4	✓	TTD Alu replaceable drill head	03-Alu		212
	12 - 32,49	3	3	✓	TTD-Tritan Uni replaceable drill head	01-Uni		230
	9 - 50	2	2	✓	QTD Steel Indexable Insert	01-Steel		186
	14 - 32	2	2	✓	QTD Steel-Pyramid Indexable Insert	05-Pyramid		188
	10 - 33	2	2	✓	QTD Uni EK-Shaped Indexable Insert	10-Uni		190
	9 - 50	2	2	✓	QTD Inox Indexable Insert	02-Inox		191
	9 - 50	2	2	✓	QTD Iron Indexable Insert	04-Iron		193
	9 - 50	2	2	✓	QTD Alu Indexable Insert	03-Alu		194
	16 - 54,9	1	4	✓	WOGT Indexable Insert	WOGT-X40		241

* n_{GC} = Number of guiding chamfers

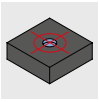

Spot drilling

Design	Product category	Material suitability						Bore features							Drilling depth							
		P	M	K	N	S	H	HFC	HSC	Fluted	Double-fluted	Single-fluted	Double-fluted	180°	Tolerance	1xD	1.5xD	3xD	5xD	8xD	12xD	
	Expert LINE	■	■	■	■	■	■															
	Basic LINE	■	■	■	■	■	■															
	Basic LINE	■	■	■	■	■	■															

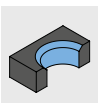

Stepped drilling

Design	Product category	Material suitability						Bore features							Drilling depth							
		P	M	K	N	S	H	HFC	HSC	Fluted	Double-fluted	Single-fluted	Double-fluted	180°	Tolerance	1xD	1.5xD	3xD	5xD	8xD	12xD	
	Expert LINE	■	■	■	■	■	■	✓							IT9							
	Performance LINE	■	■	■	■	■	■								IT9							

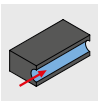

Deep drilling

Design	Product category	Material suitability						Bore features							Drilling depth							
		P	M	K	N	S	H	HFC	HSC	Fluted	Double-fluted	Single-fluted	Double-fluted	180°	Tolerance	15xD	20xD	25xD	30xD	40xD		
	Performance LINE	■	■	■	■	■	■															
		■	■	■	■	■	■							✓	IT9	✓	✓	✓	✓	✓		
		■	■	■	■	■	■							✓	IT9		✓	✓	✓	✓		

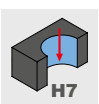

Drill reaming

Design	Product category	Material suitability						Bore features							Drilling depth							
		P	M	K	N	S	H	HFC	HSC	Fluted	Double-fluted	Single-fluted	Double-fluted	180°	Tolerance	1xD	1.5xD	3xD	5xD	8xD	12xD	
	Expert LINE	■	■	■	■	■	■				✓	✓	✓	✓	IT7				✓	✓		

■ highly suitable

▣ suitable in some situations

Step 1:
Application

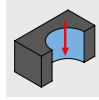

Step 2:
Design



Step 3:
Product category



Step 4:
Material suitability



Step 5:
Part features



Step 6:
Design



Design					Product			
ø [mm]	z	n _{GC} *			Product name	Specification		Page
4 - 20	3	0			Tritan-Spot-Drill-Steel	SCD670		246
0,5 - 2,5	2	2			ECU-Centre-Drill	SCD450		248
8 - 20	2	0			CPD-Spot-Drill	CPD100		249

Design					Product			
ø [mm]	z	n _{GC} *			Product name	Specification		Page
3,98 - 17,50	3	3	✓		Tritan-Step-Drill-Steel	SCD561		258
2,5 - 14	2	2	✓		MEGA-Step-Drill-Steel-Plus	SCD590, 591		259

Design					Product			
ø [mm]	z	n _{GC} *			Product name	Specification		Page
1 - 3	2	2	✓		MICRO-Step-Drill-Steel	SCD581		268
1 - 16	2	4	✓		MICRO-Deep-Drill MEGA-Deep-Drill	SCD171		269
3 - 12	2	4	✓		MEGA-Deep-Drill-Alu	SCD181		278

Design					Product			
ø [mm]	z	n _{GC} *			Product name	Specification		Page
3,80 - 20,05	3		✓		Tritan-Drill-Reamer	SDR301		292

* n_{GC} = Number of guiding chamfers

Product ID codes

Solid carbide drill

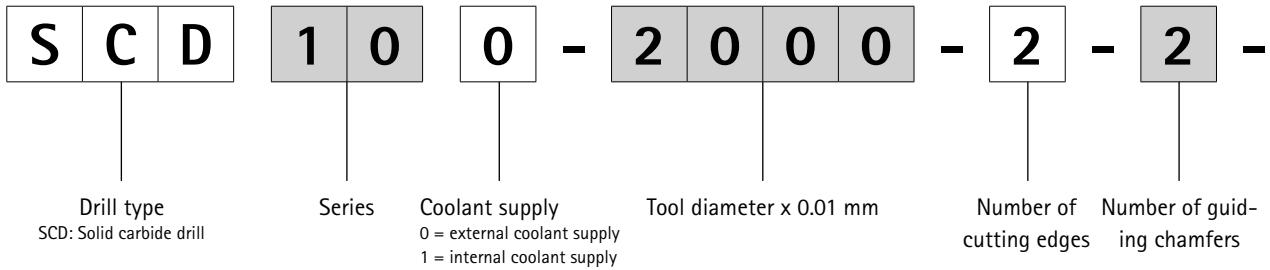

Drill reamers

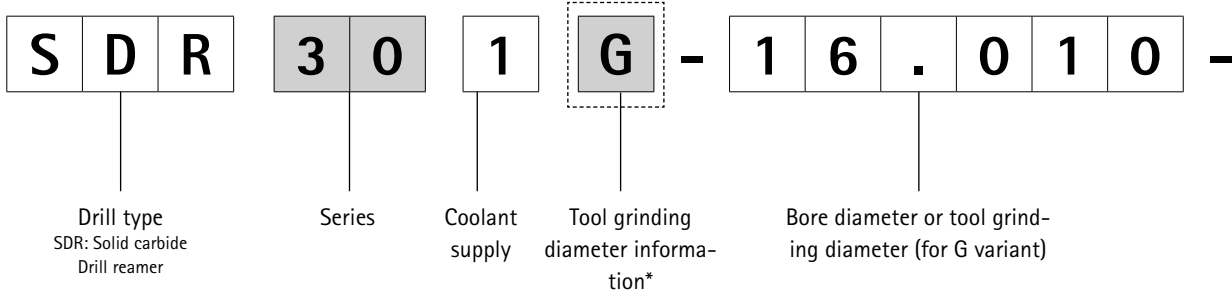

QTD and TTD changing systems

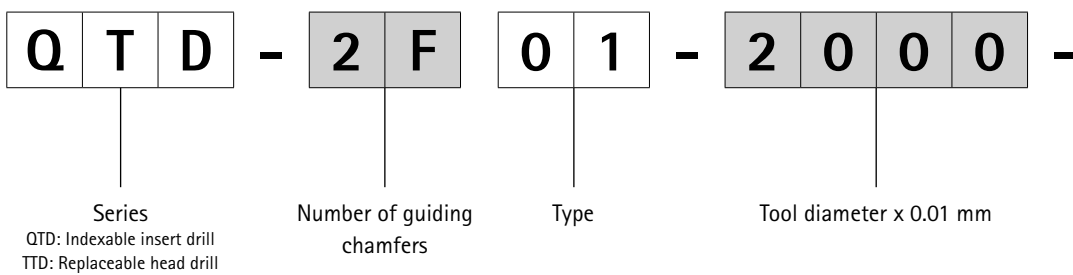

* Letter is only included for G variants

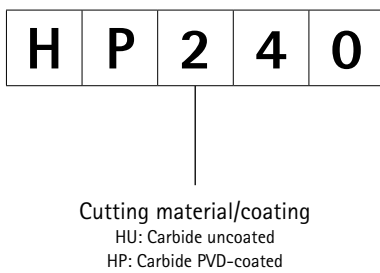
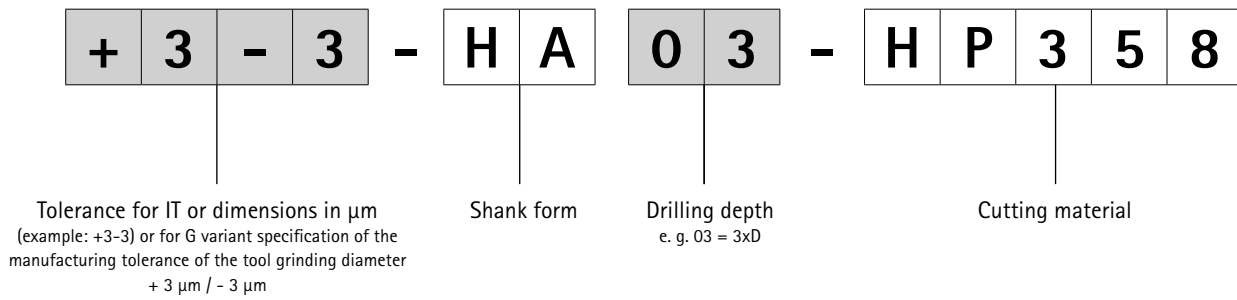
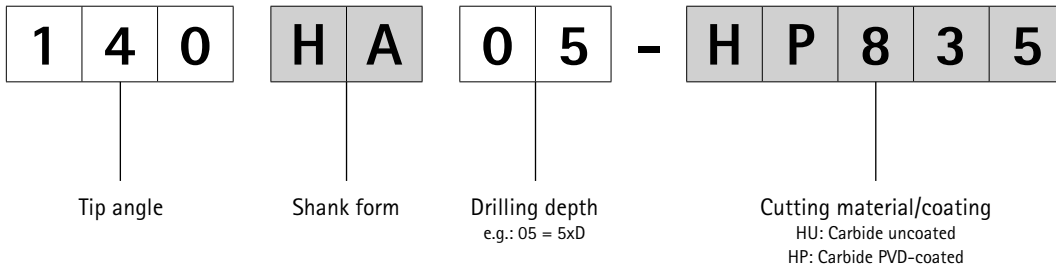

Product ID codes

TTD-Tritan changing system

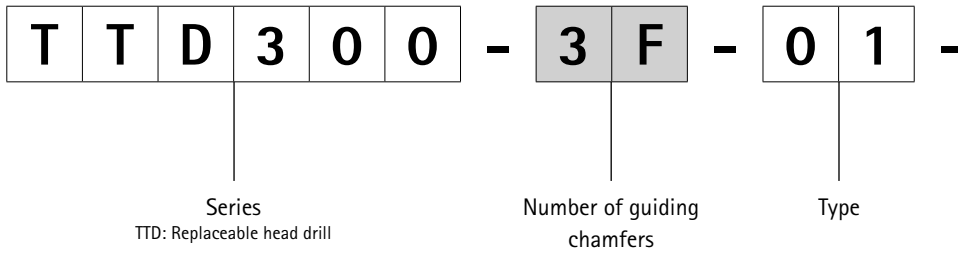

Holder Range TTS for TTD-Tritan

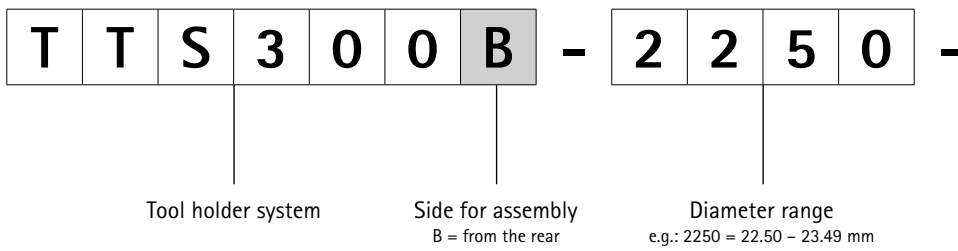

QTS for QTD holder range

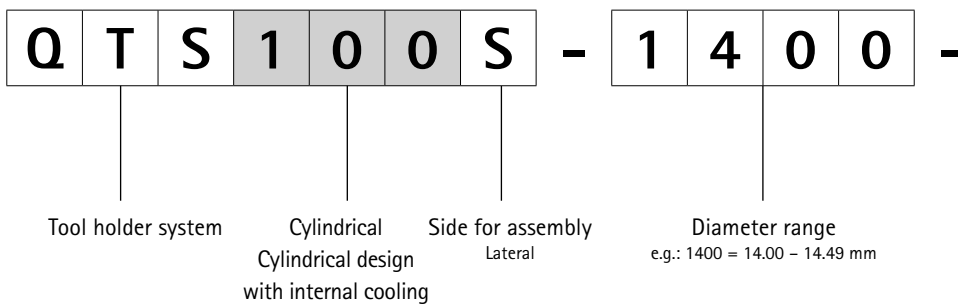

TTS for TTD holder range

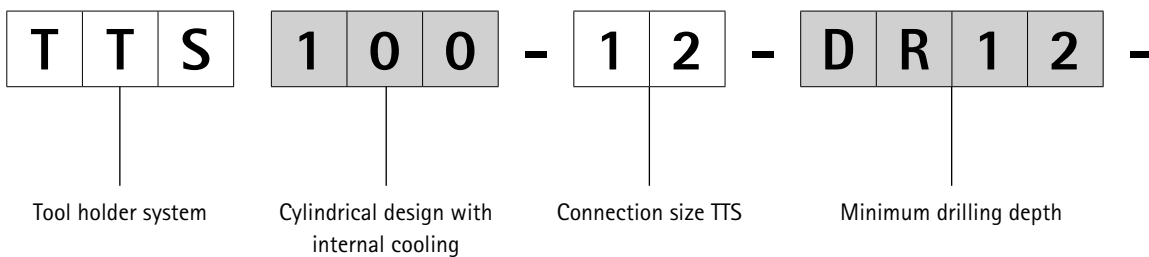

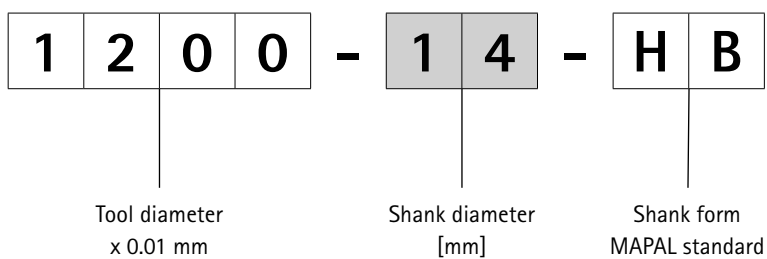
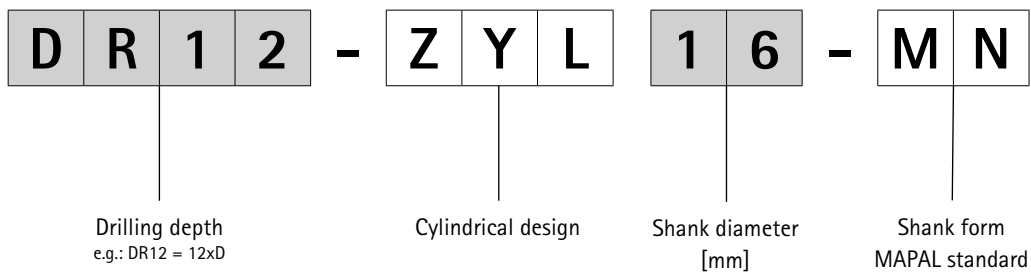
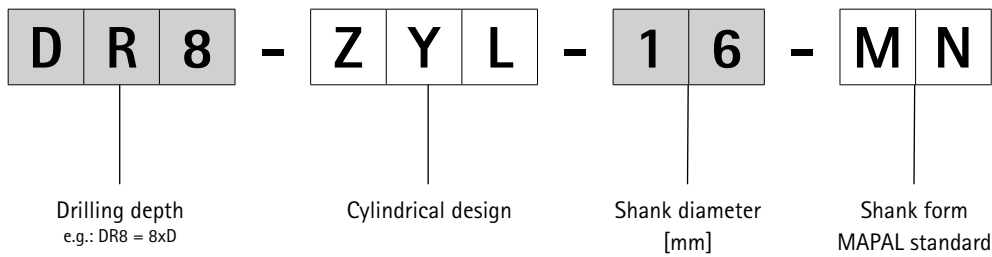
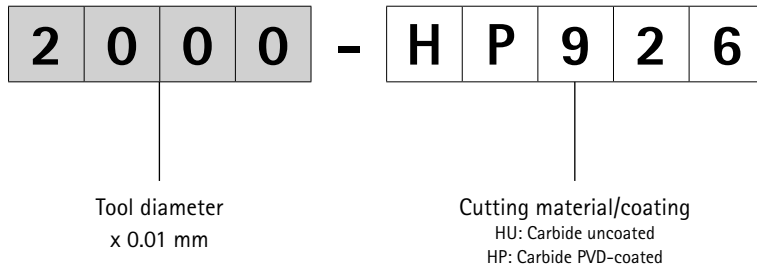



DRILLING FROM THE SOLID WITH SOLID CARBIDE

Universal application

Tritan-Drill-Uni-Plus	30
MEGA-Speed-Drill-Uni	36
ECU-Drill-Uni	42

Steel and hardened steel

MEGA-Drill-Steel-Plus	51
MEGA-Quadro-Drill-Plus	70
MICRO-Drill-Steel	79
MEGA-Drill-Hardened	82
Tritan-Drill-Steel	85
MEGA-Speed-Drill-Steel	95
MEGA 180° Drill	105
ECU-Drill-Steel	111

Inox and cast iron

MEGA-Drill-Inox	129
MEGA-Speed-Drill-Inox	142
MEGA-Speed-Drill-Iron	150

Aluminium and composite materials

MEGA-Drill-Alu	151
MEGA-Drill-Composite-MD	156
MEGA-Drill-Composite-UDX	158
MEGA-180°-Drill-Alu	160
ECU G Drill	164

Technical appendix

Cutting data recommendations	166
------------------------------------	-----



Tritan-Drill-Uni-Plus

Solid carbide twist drill

SCD631 (5xD), internal coolant supply, follow-up product to the Tritan-Drill-Uni (SCD44)

Design:

Drill diameter: 4.00 – 20.00 mm
 Bore tolerance: IT 9 (achievable)
 Cutting material: HP358
 Number of cutting edges: 3
 Number of guiding chamfers: 3
 Tip angle: 140°
 Helix angle: 30°

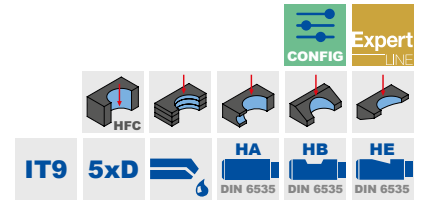
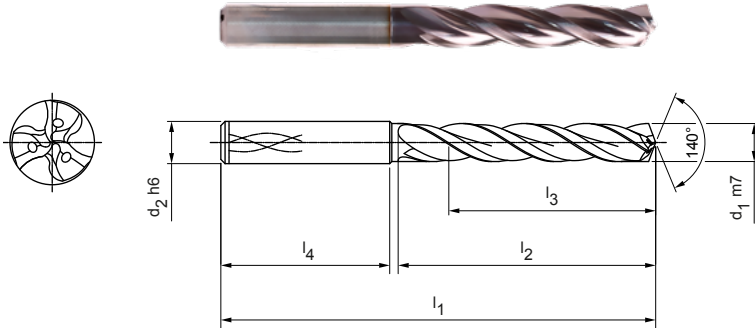

Stocked preferred series in shank form HA

Dimensions						Shank form HA	
d ₁ m7	d ₂ h6	l ₁	l ₂	l ₃	l ₄	Specification	Order no.
4,00	6	74	36	29	36	SCD631-0400-3-3-140HA05-HP358	31037282
4,10	6	74	36	29	36	SCD631-0410-3-3-140HA05-HP358	31037283
4,20	6	74	36	29	36	SCD631-0420-3-3-140HA05-HP358	31037284
4,30	6	74	36	29	36	SCD631-0430-3-3-140HA05-HP358	31037285
4,50	6	74	36	29	36	SCD631-0450-3-3-140HA05-HP358	31037287
4,80	6	82	44	35	36	SCD631-0480-3-3-140HA05-HP358	31037290
5,00	6	82	44	35	36	SCD631-0500-3-3-140HA05-HP358	31037292
5,10	6	82	44	35	36	SCD631-0510-3-3-140HA05-HP358	31037293
5,20	6	82	44	35	36	SCD631-0520-3-3-140HA05-HP358	31037294
5,30	6	82	44	35	36	SCD631-0530-3-3-140HA05-HP358	31037295
5,50	6	82	44	35	36	SCD631-0550-3-3-140HA05-HP358	31037297
5,55	6	82	44	35	36	SCD631-0555-3-3-140HA05-HP358	31307521
5,60	6	82	44	35	36	SCD631-0560-3-3-140HA05-HP358	31037298
5,70	6	82	44	35	36	SCD631-0570-3-3-140HA05-HP358	31037299
5,80	6	82	44	35	36	SCD631-0580-3-3-140HA05-HP358	31037300
5,90	6	82	44	35	36	SCD631-0590-3-3-140HA05-HP358	31037301
6,00	6	82	44	35	36	SCD631-0600-3-3-140HA05-HP358	31037302
6,10	8	91	53	43	36	SCD631-0610-3-3-140HA05-HP358	31037303
6,20	8	91	53	43	36	SCD631-0620-3-3-140HA05-HP358	31037304
6,30	8	91	53	43	36	SCD631-0630-3-3-140HA05-HP358	31037305
6,40	8	91	53	43	36	SCD631-0640-3-3-140HA05-HP358	31037306
6,50	8	91	53	43	36	SCD631-0650-3-3-140HA05-HP358	31037307
6,70	8	91	53	43	36	SCD631-0670-3-3-140HA05-HP358	31037309
6,80	8	91	53	43	36	SCD631-0680-3-3-140HA05-HP358	31037310
6,90	8	91	53	43	36	SCD631-0690-3-3-140HA05-HP358	31037311
7,00	8	91	53	43	36	SCD631-0700-3-3-140HA05-HP358	31037312
7,40	8	91	53	43	36	SCD631-0740-3-3-140HA05-HP358	31037316
7,50	8	91	53	43	36	SCD631-0750-3-3-140HA05-HP358	31037317
7,70	8	91	53	43	36	SCD631-0770-3-3-140HA05-HP358	31037319
7,80	8	91	53	43	36	SCD631-0780-3-3-140HA05-HP358	31037320
7,90	8	91	53	43	36	SCD631-0790-3-3-140HA05-HP358	31037321
8,00	8	91	53	43	36	SCD631-0800-3-3-140HA05-HP358	31037322
8,10	10	103	61	49	40	SCD631-0810-3-3-140HA05-HP358	31037323
8,50	10	103	61	49	40	SCD631-0850-3-3-140HA05-HP358	31037327
8,60	10	103	61	49	40	SCD631-0860-3-3-140HA05-HP358	31037328

Tritan-Drill-Uni-Plus | Solid carbide twist drill SCD631 (5xD), internal coolant supply

Dimensions						Shank form HA	
d ₁ m7	d ₂ h6	l ₁	l ₂	l ₃	l ₄	Specification	Order no.
8,80	10	103	61	49	40	SCD631-0880-3-3-140HA05-HP358	31037330
9,00	10	103	61	49	40	SCD631-0900-3-3-140HA05-HP358	31037332
9,30	10	103	61	49	40	SCD631-0930-3-3-140HA05-HP358	31037335
9,50	10	103	61	49	40	SCD631-0950-3-3-140HA05-HP358	31037337
9,80	10	103	61	49	40	SCD631-0980-3-3-140HA05-HP358	31037340
9,90	10	103	61	49	40	SCD631-0990-3-3-140HA05-HP358	31037341
10,00	10	103	61	49	40	SCD631-1000-3-3-140HA05-HP358	31037342
10,20	12	118	71	56	45	SCD631-1020-3-3-140HA05-HP358	31037344
10,50	12	118	71	56	45	SCD631-1050-3-3-140HA05-HP358	31037347
11,00	12	118	71	56	45	SCD631-1100-3-3-140HA05-HP358	31037352
11,20	12	118	71	56	45	SCD631-1120-3-3-140HA05-HP358	31037354
11,50	12	118	71	56	45	SCD631-1150-3-3-140HA05-HP358	31037357
11,70	12	118	71	56	45	SCD631-1170-3-3-140HA05-HP358	31037359
11,80	12	118	71	56	45	SCD631-1180-3-3-140HA05-HP358	31037360
12,00	12	118	71	56	45	SCD631-1200-3-3-140HA05-HP358	31037362
12,50	14	124	77	60	45	SCD631-1250-3-3-140HA05-HP358	31037364
13,00	14	124	77	60	45	SCD631-1300-3-3-140HA05-HP358	31037366
13,50	14	124	77	60	45	SCD631-1350-3-3-140HA05-HP358	31037368
13,80	14	124	77	60	45	SCD631-1380-3-3-140HA05-HP358	31037369
14,00	14	124	77	60	45	SCD631-1400-3-3-140HA05-HP358	31037370
14,50	16	133	83	63	48	SCD631-1450-3-3-140HA05-HP358	31037372
14,80	16	133	83	63	48	SCD631-1480-3-3-140HA05-HP358	31037373
15,00	16	133	83	63	48	SCD631-1500-3-3-140HA05-HP358	31037374
15,50	16	133	83	63	48	SCD631-1550-3-3-140HA05-HP358	31037376
16,00	16	133	83	63	48	SCD631-1600-3-3-140HA05-HP358	31037378
17,00	18	143	93	71	48	SCD631-1700-3-3-140HA05-HP358	31037382
17,50	18	143	93	71	48	SCD631-1750-3-3-140HA05-HP358	31037384
18,00	18	143	93	71	48	SCD631-1800-3-3-140HA05-HP358	31037386
18,50	20	153	101	77	50	SCD631-1850-3-3-140HA05-HP358	31037388
19,80	20	153	101	77	50	SCD631-1980-3-3-140HA05-HP358	31037393
20,00	20	153	101	77	50	SCD631-2000-3-3-140HA05-HP358	31037394

Configurable features



Diameter:
Diameter in increments of
0.01 mm freely selectable



Shank form:
Shank form: HB | HE

Specification:

SCD631-[diameter]-3-3-140[shank form]05-HP358

Dimensions of configurable series

d ₁ min.	d ₁ max.	d ₂ h6	l ₁	l ₂	l ₃	l ₄
4,00	4,70	6	74	36	29	36
4,71	6,00	6	82	44	35	36
6,01	8,00	8	91	53	43	36
8,01	10,00	10	103	61	49	40
10,01	12,00	12	118	71	56	45
12,01	14,00	14	124	77	60	45
14,01	16,00	16	133	83	63	48
16,01	18,00	18	143	93	71	48
18,01	20,00	20	153	101	77	50

Example:

SCD631-0431-3-3-140HE05-HP358

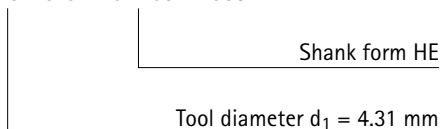

Dimensions in mm.

For cutting data recommendations, see end of chapter.

Special designs and other coatings available upon request.

Tritan-Drill-Uni-Plus

Solid carbide twist drill

SCD631 (8xD), internal coolant supply, follow-up product to the Tritan-Drill-Uni (SCD44)

Design:

Drill diameter: 4.00 – 20.00 mm
 Bore tolerance: IT 9 (achievable)
 Cutting material: HP358
 Number of cutting edges: 3
 Number of guiding chamfers: 3
 Tip angle: 135°
 Helix angle: 30°

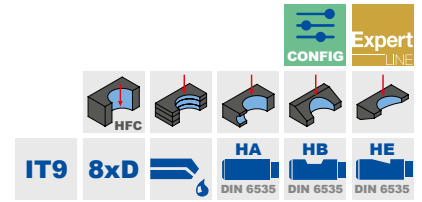
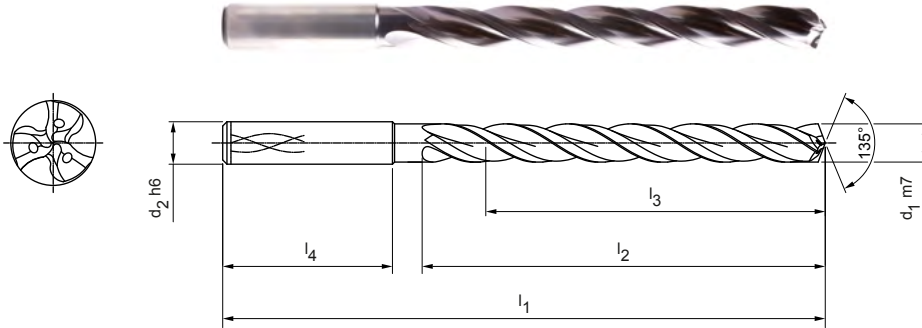

Stocked preferred series in shank form HA

Dimensions						Shank form HA	
d ₁ m7	d ₂ h6	l ₁	l ₂	l ₃	l ₄	Specification	Order no.
4,00	6	81	43	36	36	SCD631-0400-3-3-135HA08-HP358	31037395
4,10	6	81	43	36	36	SCD631-0410-3-3-135HA08-HP358	31037396
4,30	6	81	43	36	36	SCD631-0430-3-3-135HA08-HP358	31037398
4,50	6	81	43	36	36	SCD631-0450-3-3-135HA08-HP358	31037400
4,60	6	81	43	36	36	SCD631-0460-3-3-135HA08-HP358	31037401
4,70	6	81	43	36	36	SCD631-0470-3-3-135HA08-HP358	31037402
4,90	6	95	57	48	36	SCD631-0490-3-3-135HA08-HP358	31037404
5,00	6	95	57	48	36	SCD631-0500-3-3-135HA08-HP358	31037405
5,03	6	95	57	48	36	SCD631-0503-3-3-135HA08-HP358	31266415
5,10	6	95	57	48	36	SCD631-0510-3-3-135HA08-HP358	31037406
5,20	6	95	57	48	36	SCD631-0520-3-3-135HA08-HP358	31037407
5,50	6	95	57	48	36	SCD631-0550-3-3-135HA08-HP358	31037410
5,60	6	95	57	48	36	SCD631-0560-3-3-135HA08-HP358	31037411
5,80	6	95	57	48	36	SCD631-0580-3-3-135HA08-HP358	31037413
6,00	6	95	57	48	36	SCD631-0600-3-3-135HA08-HP358	31037415
6,10	8	114	76	64	36	SCD631-0610-3-3-135HA08-HP358	31037416
6,50	8	114	76	64	36	SCD631-0650-3-3-135HA08-HP358	31037420
6,80	8	114	76	64	36	SCD631-0680-3-3-135HA08-HP358	31037423
6,90	8	114	76	64	36	SCD631-0690-3-3-135HA08-HP358	31037424
7,00	8	114	76	64	36	SCD631-0700-3-3-135HA08-HP358	31037425
7,10	8	114	76	64	36	SCD631-0710-3-3-135HA08-HP358	31037426
7,50	8	114	76	64	36	SCD631-0750-3-3-135HA08-HP358	31037430
7,80	8	114	76	64	36	SCD631-0780-3-3-135HA08-HP358	31037433
7,90	8	114	76	64	36	SCD631-0790-3-3-135HA08-HP358	31037434
8,00	8	114	76	64	36	SCD631-0800-3-3-135HA08-HP358	31037435
8,50	10	142	95	80	40	SCD631-0850-3-3-135HA08-HP358	31037440
8,80	10	142	95	80	40	SCD631-0880-3-3-135HA08-HP358	31037443
9,00	10	142	95	80	40	SCD631-0900-3-3-135HA08-HP358	31037445
9,10	10	142	95	80	40	SCD631-0910-3-3-135HA08-HP358	31037446
9,40	10	142	95	80	40	SCD631-0940-3-3-135HA08-HP358	31037449
9,50	10	142	95	80	40	SCD631-0950-3-3-135HA08-HP358	31037450
9,80	10	142	95	80	40	SCD631-0980-3-3-135HA08-HP358	31037453
10,00	10	142	95	80	40	SCD631-1000-3-3-135HA08-HP358	31037455
11,00	12	162	114	96	45	SCD631-1100-3-3-135HA08-HP358	31037465
11,80	12	162	114	96	45	SCD631-1180-3-3-135HA08-HP358	31037473

Tritan-Drill-Uni-Plus | Solid carbide twist drill SCD631 (8xD), internal coolant supply

Dimensions						Shank form HA	
d ₁ m7	d ₂ h6	l ₁	l ₂	l ₃	l ₄	Specification	Order no.
12,00	12	162	114	96	45	SCD631-1200-3-3-135HA08-HP358	31037475
12,50	14	178	133	112	45	SCD631-1250-3-3-135HA08-HP358	31037477
13,00	14	178	133	112	45	SCD631-1300-3-3-135HA08-HP358	31037479
13,50	14	178	133	112	45	SCD631-1350-3-3-135HA08-HP358	31037481
14,00	14	178	133	112	45	SCD631-1400-3-3-135HA08-HP358	31037483
15,00	16	203	152	128	48	SCD631-1500-3-3-135HA08-HP358	31037487
16,00	16	203	152	128	48	SCD631-1600-3-3-135HA08-HP358	31037491
17,00	18	222	171	144	48	SCD631-1700-3-3-135HA08-HP358	31037495

Configurable features



Diameter:
Diameter in increments of
0.01 mm freely selectable



Shank form:
Shank form: HB | HE

Specification:

SCD631-[diameter]-3-3-140[shank form]08-HP358

Dimensions of configurable series

d ₁ min.	d ₁ max.	d ₂ h6	l ₁	l ₂	l ₃	l ₄
4,00	4,70	6	81	43	36	36
4,71	6,00	6	95	57	48	36
6,01	8,00	8	114	76	64	36
8,01	10,00	10	142	95	80	40
10,01	12,00	12	162	114	96	45
12,01	14,00	14	178	133	112	45
14,01	16,00	16	203	152	128	48
16,01	18,00	18	222	171	144	48
18,01	20,00	20	243	190	160	50

Example:

SCD631-0431-3-3-140HE08-HP358

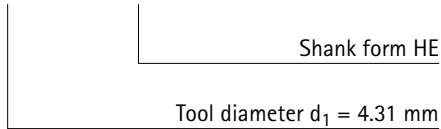

Dimensions in mm.

For cutting data recommendations, see end of chapter.

Special designs and other coatings available upon request.

Tritan-Drill-Uni-Plus

Solid carbide twist drill

SCD631 (12xD), internal coolant supply, follow-up product to the Tritan-Drill-Uni (SCD44)

Design:

Drill diameter: 4.00 – 20.00 mm
 Bore tolerance: IT 9 (achievable)
 Cutting material: HP358
 Number of cutting edges: 3
 Number of guiding chamfers: 3
 Tip angle: 135°
 Helix angle: 30°

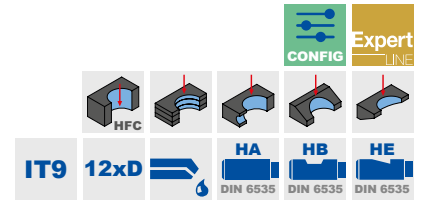
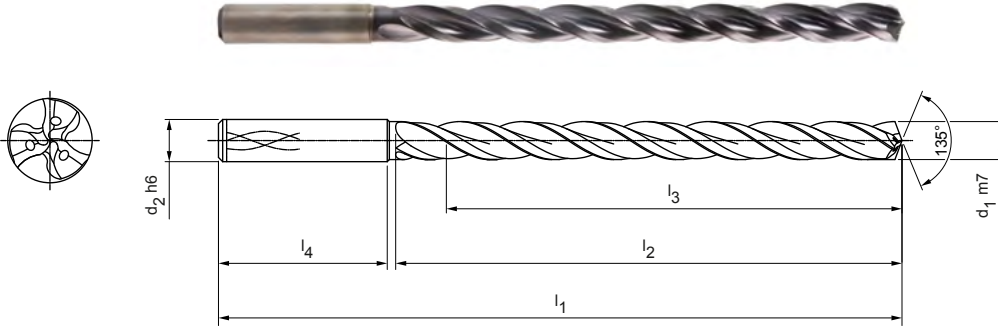

Stocked preferred series in shank form HA

Dimensions						Shank form HA	
d ₁ m7	d ₂ h6	l ₁	l ₂	l ₃	l ₄	Specification	Order no.
4,00	6	102	64	58	36	SCD631-0400-3-3-135HA12-HP358	31035357
4,10	6	102	64	58	36	SCD631-0410-3-3-135HA12-HP358	31035358
4,20	6	102	64	58	36	SCD631-0420-3-3-135HA12-HP358	31035359
4,30	6	102	64	58	36	SCD631-0430-3-3-135HA12-HP358	31035360
4,50	6	102	64	58	36	SCD631-0450-3-3-135HA12-HP358	31035362
4,60	6	102	64	58	36	SCD631-0460-3-3-135HA12-HP358	31035363
4,70	6	102	64	58	36	SCD631-0470-3-3-135HA12-HP358	31035364
4,80	6	116	78	70	36	SCD631-0480-3-3-135HA12-HP358	31035365
5,00	6	116	78	70	36	SCD631-0500-3-3-135HA12-HP358	31035367
5,10	6	116	78	70	36	SCD631-0510-3-3-135HA12-HP358	31035368
5,20	6	116	78	70	36	SCD631-0520-3-3-135HA12-HP358	31035369
5,40	6	116	78	70	36	SCD631-0540-3-3-135HA12-HP358	31035371
5,50	6	116	78	70	36	SCD631-0550-3-3-135HA12-HP358	31035372
5,80	6	116	78	70	36	SCD631-0580-3-3-135HA12-HP358	31035375
6,00	6	116	78	70	36	SCD631-0600-3-3-135HA12-HP358	31035377
6,10	8	146	108	94	36	SCD631-0610-3-3-135HA12-HP358	31035378
6,20	8	146	108	94	36	SCD631-0620-3-3-135HA12-HP358	31035379
6,50	8	146	108	94	36	SCD631-0650-3-3-135HA12-HP358	31035382
6,60	8	146	108	94	36	SCD631-0660-3-3-135HA12-HP358	31035383
6,80	8	146	108	94	36	SCD631-0680-3-3-135HA12-HP358	31035385
7,00	8	146	108	94	36	SCD631-0700-3-3-135HA12-HP358	31035387
7,50	8	146	108	94	36	SCD631-0750-3-3-135HA12-HP358	31035392
7,80	8	146	108	94	36	SCD631-0780-3-3-135HA12-HP358	31035395
8,00	8	146	108	94	36	SCD631-0800-3-3-135HA12-HP358	31035397
8,50	10	162	120	110	40	SCD631-0850-3-3-135HA12-HP358	31035402
9,00	10	162	120	110	40	SCD631-0900-3-3-135HA12-HP358	31035407
9,50	10	162	120	110	40	SCD631-0950-3-3-135HA12-HP358	31035412
9,80	10	162	120	110	40	SCD631-0980-3-3-135HA12-HP358	31035415
9,90	10	162	120	110	40	SCD631-0990-3-3-135HA12-HP358	31035416
10,00	10	162	120	110	40	SCD631-1000-3-3-135HA12-HP358	31035417
10,20	12	204	156	142	45	SCD631-1020-3-3-135HA12-HP358	31035419
10,50	12	204	156	142	45	SCD631-1050-3-3-135HA12-HP358	31035422
11,00	12	204	156	142	45	SCD631-1100-3-3-135HA12-HP358	31035427
11,30	12	204	156	142	45	SCD631-1130-3-3-135HA12-HP358	31035430
11,80	12	204	156	142	45	SCD631-1180-3-3-135HA12-HP358	31035435

Tritan-Drill-Uni-Plus | Solid carbide twist drill SCD631 (12xD), internal coolant supply

Dimensions						Shank form HA	
d ₁ m7	d ₂ h6	l ₁	l ₂	l ₃	l ₄	Specification	Order no.
12,00	12	204	156	142	45	SCD631-1200-3-3-135HA12-HP358	31035437
12,50	14	230	182	166	45	SCD631-1250-3-3-135HA12-HP358	31035439
13,00	14	230	182	166	45	SCD631-1300-3-3-135HA12-HP358	31035441
13,50	14	230	182	166	45	SCD631-1350-3-3-135HA12-HP358	31035443
13,80	14	230	182	166	45	SCD631-1380-3-3-135HA12-HP358	31035444
14,00	14	230	182	166	45	SCD631-1400-3-3-135HA12-HP358	31035445
15,00	16	260	208	192	48	SCD631-1500-3-3-135HA12-HP358	31035449
15,80	16	260	208	192	48	SCD631-1580-3-3-135HA12-HP358	31035452
16,00	16	260	208	192	48	SCD631-1600-3-3-135HA12-HP358	31035453

Configurable features

**Diameter:**

Diameter in increments of 0.01 mm freely selectable

**Shank form:**

Shank form: HB | HE

Specification:

SCD631-[diameter]-3-3-140[shank form]12-HP358

Dimensions of configurable series

d ₁ min.	d ₁ max.	d ₂ h6	l ₁	l ₂	l ₃	l ₄
4,00	4,70	6	102	64	58	36
4,71	6,00	6	116	78	70	36
6,01	8,00	8	146	108	94	36
8,01	10,00	10	162	120	110	40
10,01	12,00	12	204	156	142	45
12,01	14,00	14	230	182	166	45
14,01	16,00	16	260	208	192	48
16,01	18,00	18	285	234	216	48
18,01	20,00	20	310	258	240	50

Example:

SCD631-0431-3-3-140HE12-HP358

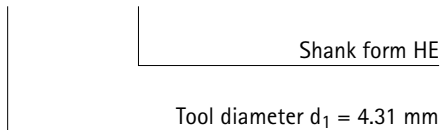

Dimensions in mm.

For cutting data recommendations, see end of chapter.

Special designs and other coatings available upon request.

MEGA-Speed-Drill-Uni

Solid carbide twist drill
SCD221 (3xD), internal coolant supply

Design:
 Drill diameter: 3.00 – 20.00 mm
 Bore tolerance: ≥ IT 9
 Cutting material: HP374
 Number of cutting edges: 2
 Number of guiding chamfers: 3
 Tip angle: 135°
 Helix angle: 30°

Application:
 For high-speed machining.

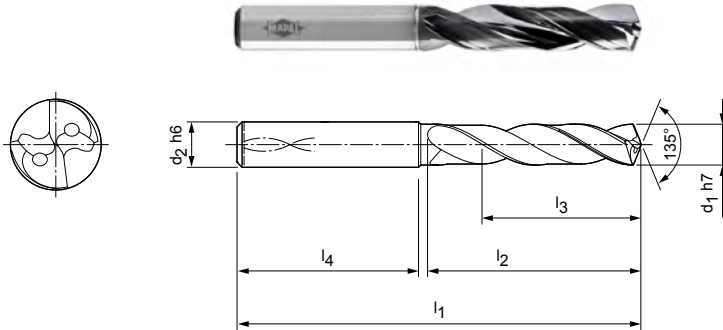

Stocked preferred series in shank form HA

Dimensions						Shank form HA	
d ₁ h7	d ₂ h6	l ₁	l ₂	l ₃	l ₄	Specification	Order no.
3,00	6	62	20	14	36	SCD221-0300-2-3-135HA03-HP374	30404127
3,10	6	62	20	14	36	SCD221-0310-2-3-135HA03-HP374	30404128
3,20	6	62	20	14	36	SCD221-0320-2-3-135HA03-HP374	30404129
3,30	6	62	20	14	36	SCD221-0330-2-3-135HA03-HP374	30404130
3,40	6	62	20	14	36	SCD221-0340-2-3-135HA03-HP374	30404131
3,50	6	62	20	14	36	SCD221-0350-2-3-135HA03-HP374	30404132
3,70	6	62	20	14	36	SCD221-0370-2-3-135HA03-HP374	30404134
4,00	6	66	24	17	36	SCD221-0400-2-3-135HA03-HP374	30404137
4,20	6	66	24	17	36	SCD221-0420-2-3-135HA03-HP374	30404139
4,30	6	66	24	17	36	SCD221-0430-2-3-135HA03-HP374	30404140
4,50	6	66	24	17	36	SCD221-0450-2-3-135HA03-HP374	30404142
5,00	6	66	28	20	36	SCD221-0500-2-3-135HA03-HP374	30404148
5,10	6	66	28	20	36	SCD221-0510-2-3-135HA03-HP374	30404149
5,20	6	66	28	20	36	SCD221-0520-2-3-135HA03-HP374	30404150
5,50	6	66	28	20	36	SCD221-0550-2-3-135HA03-HP374	30404153
5,55	6	66	28	20	36	SCD221-0555-2-3-135HA03-HP374	30404154
5,60	6	66	28	20	36	SCD221-0560-2-3-135HA03-HP374	30404155
5,80	6	66	28	20	36	SCD221-0580-2-3-135HA03-HP374	30404157
6,00	6	66	28	20	36	SCD221-0600-2-3-135HA03-HP374	30404159
6,30	8	79	34	24	36	SCD221-0630-2-3-135HA03-HP374	30404162
6,50	8	79	34	24	36	SCD221-0650-2-3-135HA03-HP374	30404164
6,80	8	79	34	24	36	SCD221-0680-2-3-135HA03-HP374	30404167
6,90	8	79	34	24	36	SCD221-0690-2-3-135HA03-HP374	30404168
7,00	8	79	34	24	36	SCD221-0700-2-3-135HA03-HP374	30404169
7,40	8	79	41	29	36	SCD221-0740-2-3-135HA03-HP374	30404173
7,50	8	79	41	29	36	SCD221-0750-2-3-135HA03-HP374	30404175
7,80	8	79	41	29	36	SCD221-0780-2-3-135HA03-HP374	30404178
8,00	8	79	41	29	36	SCD221-0800-2-3-135HA03-HP374	30404180
8,50	10	89	47	35	40	SCD221-0850-2-3-135HA03-HP374	30404185
8,60	10	89	47	35	40	SCD221-0860-2-3-135HA03-HP374	30404186
8,80	10	89	47	35	40	SCD221-0880-2-3-135HA03-HP374	30404188
9,00	10	89	47	35	40	SCD221-0900-2-3-135HA03-HP374	30404190
9,50	10	89	47	35	40	SCD221-0950-2-3-135HA03-HP374	30404195
9,80	10	89	47	35	40	SCD221-0980-2-3-135HA03-HP374	30404198
9,90	10	89	47	35	40	SCD221-0990-2-3-135HA03-HP374	30404199

MEGA-Speed-Drill-Uni | Solid carbide twist drill SCD221 (3xD), internal coolant supply

Dimensions						Shank form HA	
d ₁ h7	d ₂ h6	l ₁	l ₂	l ₃	l ₄	Specification	Order no.
10,00	10	89	47	35	40	SCD221-1000-2-3-135HA03-HP374	30404200
10,20	12	102	55	40	45	SCD221-1020-2-3-135HA03-HP374	30404202
10,30	12	102	55	40	45	SCD221-1030-2-3-135HA03-HP374	30404203
10,50	12	102	55	40	45	SCD221-1050-2-3-135HA03-HP374	30404205
10,60	12	102	55	40	45	SCD221-1060-2-3-135HA03-HP374	30404206
11,00	12	102	55	40	45	SCD221-1100-2-3-135HA03-HP374	30404210
11,50	12	102	55	40	45	SCD221-1150-2-3-135HA03-HP374	30404215
11,60	12	102	55	40	45	SCD221-1160-2-3-135HA03-HP374	30404216
11,80	12	102	55	40	45	SCD221-1180-2-3-135HA03-HP374	30404219
12,00	12	102	55	40	45	SCD221-1200-2-3-135HA03-HP374	30404221
12,50	14	107	60	43	45	SCD221-1250-2-3-135HA03-HP374	30404222
13,00	14	107	60	43	45	SCD221-1300-2-3-135HA03-HP374	30404224
13,50	14	107	60	43	45	SCD221-1350-2-3-135HA03-HP374	30404225
14,00	14	107	60	43	45	SCD221-1400-2-3-135HA03-HP374	30404227
14,50	16	115	65	45	48	SCD221-1450-2-3-135HA03-HP374	30404228
15,00	16	115	65	45	48	SCD221-1500-2-3-135HA03-HP374	30404230
16,00	16	115	65	45	48	SCD221-1600-2-3-135HA03-HP374	30404233
17,00	18	123	73	51	48	SCD221-1700-2-3-135HA03-HP374	30404236
17,50	18	123	73	51	48	SCD221-1750-2-3-135HA03-HP374	30404237
17,80	18	123	73	51	48	SCD221-1780-2-3-135HA03-HP374	30404238
18,00	18	123	73	51	48	SCD221-1800-2-3-135HA03-HP374	30404239
18,50	20	131	79	55	50	SCD221-1850-2-3-135HA03-HP374	30404240
19,50	20	131	79	55	50	SCD221-1950-2-3-135HA03-HP374	30404243
20,00	20	131	79	55	50	SCD221-2000-2-3-135HA03-HP374	30404245

Configurable features



Diameter:
Diameter in increments of
0.01 mm freely selectable



Shank form:
Shank form: HB | HE

Specification:

SCD221-[diameter]-3-3-140[shank form]03-HP358

Dimensions of configurable series

d ₁ min.	d ₁ max.	d ₂ h6	l ₁	l ₂	l ₃	l ₄
3,00	3,70	6	62	20	14	36
3,71	4,70	6	66	24	17	36
4,71	6,00	6	66	28	20	36
6,01	8,00	8	79	34	24	36
8,01	10,00	10	89	47	35	40
10,01	12,00	12	102	55	40	45
12,01	14,00	14	107	60	43	45
14,01	16,00	16	115	65	45	48
16,01	18,00	18	123	73	51	48
18,01	20,00	20	131	79	55	50

Example:

SCD221-0431-3-3-140HE03-HP358

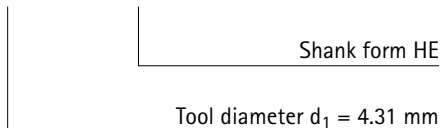

Dimensions in mm.

For cutting data recommendations, see end of chapter.

Special designs and other coatings available upon request.

MEGA-Speed-Drill-Uni

Solid carbide twist drill
SCD221 (5xD), internal coolant supply

Design:
 Drill diameter: 3.00 – 20.00 mm
 Bore tolerance: \geq IT 9
 Cutting material: HP374
 Number of cutting edges: 2
 Number of guiding chamfers: 3
 Tip angle: 135°
 Helix angle: 30°

Application:
 For high-speed machining.

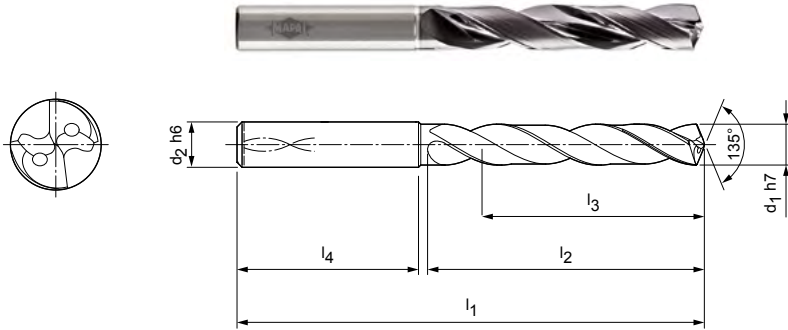

Stocked preferred series in shank form HA

Dimensions						Shank form HA	
d ₁ h7	d ₂ h6	l ₁	l ₂	l ₃	l ₄	Specification	Order no.
3,00	6	66	28	23	36	SCD221-0300-2-3-135HA05-HP374	30392925
3,10	6	66	28	23	36	SCD221-0310-2-3-135HA05-HP374	30392926
3,20	6	66	28	23	36	SCD221-0320-2-3-135HA05-HP374	30392927
3,30	6	66	28	23	36	SCD221-0330-2-3-135HA05-HP374	30392928
3,40	6	66	28	23	36	SCD221-0340-2-3-135HA05-HP374	30392929
3,50	6	66	28	23	36	SCD221-0350-2-3-135HA05-HP374	30392930
3,70	6	66	28	23	36	SCD221-0370-2-3-135HA05-HP374	30392932
4,00	6	74	36	29	36	SCD221-0400-2-3-135HA05-HP374	30392935
4,20	6	74	36	29	36	SCD221-0420-2-3-135HA05-HP374	30392937
4,30	6	74	36	29	36	SCD221-0430-2-3-135HA05-HP374	30392938
4,50	6	74	36	29	36	SCD221-0450-2-3-135HA05-HP374	30392940
5,00	6	82	44	35	36	SCD221-0500-2-3-135HA05-HP374	30392946
5,10	6	82	44	35	36	SCD221-0510-2-3-135HA05-HP374	30392947
5,20	6	82	44	35	36	SCD221-0520-2-3-135HA05-HP374	30392948
5,50	6	82	44	35	36	SCD221-0550-2-3-135HA05-HP374	30392951
5,60	6	82	44	35	36	SCD221-0560-2-3-135HA05-HP374	30392953
5,80	6	82	44	35	36	SCD221-0580-2-3-135HA05-HP374	30392955
6,00	6	82	44	35	36	SCD221-0600-2-3-135HA05-HP374	30392957
6,50	8	91	53	43	36	SCD221-0650-2-3-135HA05-HP374	30392962
6,60	8	91	53	43	36	SCD221-0660-2-3-135HA05-HP374	30392963
6,80	8	91	53	43	36	SCD221-0680-2-3-135HA05-HP374	30392965
6,90	8	91	53	43	36	SCD221-0690-2-3-135HA05-HP374	30392966
7,00	8	91	53	43	36	SCD221-0700-2-3-135HA05-HP374	30392967
7,40	8	91	53	43	36	SCD221-0740-2-3-135HA05-HP374	30392971
7,50	8	91	53	43	36	SCD221-0750-2-3-135HA05-HP374	30392972
7,80	8	91	53	43	36	SCD221-0780-2-3-135HA05-HP374	30392975
8,00	8	91	53	43	36	SCD221-0800-2-3-135HA05-HP374	30392977
8,50	10	103	61	49	40	SCD221-0850-2-3-135HA05-HP374	30392982
8,60	10	103	61	49	40	SCD221-0860-2-3-135HA05-HP374	30392983
8,80	10	103	61	49	40	SCD221-0880-2-3-135HA05-HP374	30392985
9,00	10	103	61	49	40	SCD221-0900-2-3-135HA05-HP374	30392987
9,50	10	103	61	49	40	SCD221-0950-2-3-135HA05-HP374	30392992
9,70	10	103	61	49	40	SCD221-0970-2-3-135HA05-HP374	30392994
9,80	10	103	61	49	40	SCD221-0980-2-3-135HA05-HP374	30392995
10,00	10	103	61	49	40	SCD221-1000-2-3-135HA05-HP374	30392997

MEGA-Speed-Drill-Uni | Solid carbide twist drill SCD221 (5xD), internal coolant supply

Dimensions						Shank form HA	
d ₁ h7	d ₂ h6	l ₁	l ₂	l ₃	l ₄	Specification	Order no.
10,20	12	118	71	56	45	SCD221-1020-2-3-135HA05-HP374	30392999
10,30	12	118	71	56	45	SCD221-1030-2-3-135HA05-HP374	30393000
10,50	12	118	71	56	45	SCD221-1050-2-3-135HA05-HP374	30393002
11,00	12	118	71	56	45	SCD221-1100-2-3-135HA05-HP374	30393007
11,50	12	118	71	56	45	SCD221-1150-2-3-135HA05-HP374	30393012
11,80	12	118	71	56	45	SCD221-1180-2-3-135HA05-HP374	30393015
12,00	12	118	71	56	45	SCD221-1200-2-3-135HA05-HP374	30393017
12,50	14	124	77	60	45	SCD221-1250-2-3-135HA05-HP374	30393018
13,00	14	124	77	60	45	SCD221-1300-2-3-135HA05-HP374	30393020
13,50	14	124	77	60	45	SCD221-1350-2-3-135HA05-HP374	30393021
13,80	14	124	77	60	45	SCD221-1380-2-3-135HA05-HP374	30393022
14,00	14	124	77	60	45	SCD221-1400-2-3-135HA05-HP374	30393023
14,50	16	133	83	63	48	SCD221-1450-2-3-135HA05-HP374	30393024
15,00	16	133	83	63	48	SCD221-1500-2-3-135HA05-HP374	30393026
15,50	16	133	83	63	48	SCD221-1550-2-3-135HA05-HP374	30393027
15,80	16	133	83	63	48	SCD221-1580-2-3-135HA05-HP374	30393028
16,00	16	133	83	63	48	SCD221-1600-2-3-135HA05-HP374	30393029
16,80	18	143	93	71	48	SCD221-1680-2-3-135HA05-HP374	30393031
17,00	18	143	93	71	48	SCD221-1700-2-3-135HA05-HP374	30393032
17,50	18	143	93	71	48	SCD221-1750-2-3-135HA05-HP374	30393033
17,80	18	143	93	71	48	SCD221-1780-2-3-135HA05-HP374	30393034
18,00	18	143	93	71	48	SCD221-1800-2-3-135HA05-HP374	30393035
18,50	20	153	101	77	50	SCD221-1850-2-3-135HA05-HP374	30393036
18,80	20	153	101	77	50	SCD221-1880-2-3-135HA05-HP374	30393037
19,00	20	153	101	77	50	SCD221-1900-2-3-135HA05-HP374	30393038
20,00	20	153	101	77	50	SCD221-2000-2-3-135HA05-HP374	30393041

Configurable features



Diameter:
Diameter in increments of
0.01 mm freely selectable



Shank form:
Shank form: HB | HE

Specification:

SCD221-[diameter]-3-3-140[shank form]05-HP358

Dimensions of configurable series

d ₁ min.	d ₁ max.	d ₂ h6	l ₁	l ₂	l ₃	l ₄
3,00	3,70	6	66	28	23	36
3,71	4,70	6	74		29	36
4,71	6,00	6	82	44	35	36
6,01	8,00	8	91	53	43	36
8,01	10,00	10	103	61	49	40
10,01	12,00	12	118	71	56	45
12,01	14,00	14	124	77	60	45
14,01	16,00	16	133	83	63	48
16,01	18,00	18	143	93	71	48
18,01	20,00	20	153	101	77	50

Example:

SCD221-0431-3-3-140HE05-HP374

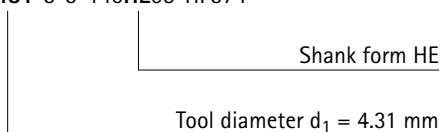

Dimensions in mm.

For cutting data recommendations, see end of chapter.

Special designs and other coatings available upon request.

MEGA-Speed-Drill-Uni

Solid carbide twist drill
SCD221 (8xD), internal coolant supply

Design:

Drill diameter: 3.00 – 20.00 mm
Bore tolerance: \geq IT 9
Cutting material: HP374
Number of cutting edges: 2
Number of guiding chamfers: 3
Tip angle: 135°
Helix angle: 30°

Application:

For high-speed machining.

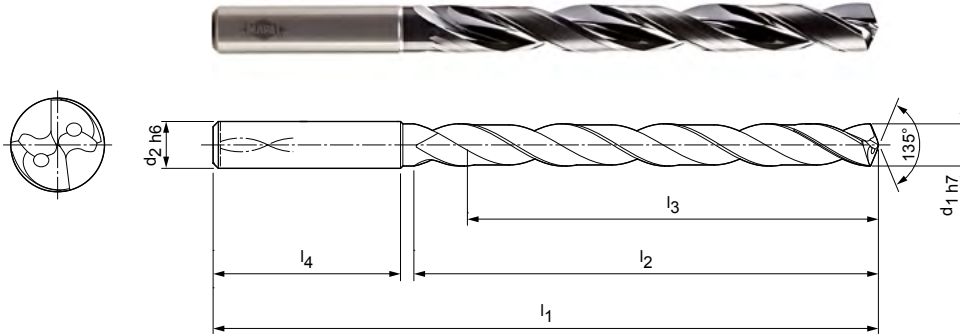

Stocked preferred series in shank form HA

Dimensions						Shank form HA	
d ₁ h7	d ₂ h6	l ₁	l ₂	l ₃	l ₄	Specification	Order no.
3,00	6	72	34	29	36	SCD221-0300-2-3-135HA08-HP374	30404000
3,20	6	72	34	29	36	SCD221-0320-2-3-135HA08-HP374	30404002
3,30	6	72	34	29	36	SCD221-0330-2-3-135HA08-HP374	30404003
3,40	6	72	34	29	36	SCD221-0340-2-3-135HA08-HP374	30404004
3,50	6	72	34	29	36	SCD221-0350-2-3-135HA08-HP374	30404005
3,70	6	72	34	29	36	SCD221-0370-2-3-135HA08-HP374	30404007
4,00	6	81	43	36	36	SCD221-0400-2-3-135HA08-HP374	30404010
4,10	6	81	43	36	36	SCD221-0410-2-3-135HA08-HP374	30404011
4,20	6	81	43	36	36	SCD221-0420-2-3-135HA08-HP374	30404012
4,30	6	81	43	36	36	SCD221-0430-2-3-135HA08-HP374	30404013
4,50	6	81	43	36	36	SCD221-0450-2-3-135HA08-HP374	30404015
4,80	6	95	57	48	36	SCD221-0480-2-3-135HA08-HP374	30404019
5,00	6	95	57	48	36	SCD221-0500-2-3-135HA08-HP374	30404021
5,10	6	95	57	48	36	SCD221-0510-2-3-135HA08-HP374	30404022
5,20	6	95	57	48	36	SCD221-0520-2-3-135HA08-HP374	30404023
5,40	6	95	57	48	36	SCD221-0540-2-3-135HA08-HP374	30404025
5,50	6	95	57	48	36	SCD221-0550-2-3-135HA08-HP374	30404026
5,80	6	95	57	48	36	SCD221-0580-2-3-135HA08-HP374	30404030
6,00	6	95	57	48	36	SCD221-0600-2-3-135HA08-HP374	30404032
6,10	8	114	76	64	36	SCD221-0610-2-3-135HA08-HP374	30404033
6,40	8	114	76	64	36	SCD221-0640-2-3-135HA08-HP374	30404036
6,50	8	114	76	64	36	SCD221-0650-2-3-135HA08-HP374	30404037
6,80	8	114	76	64	36	SCD221-0680-2-3-135HA08-HP374	30404040
7,00	8	114	76	64	36	SCD221-0700-2-3-135HA08-HP374	30404043
7,50	8	114	76	64	36	SCD221-0750-2-3-135HA08-HP374	30404048
7,80	8	114	76	64	36	SCD221-0780-2-3-135HA08-HP374	30404051
8,00	8	114	76	64	36	SCD221-0800-2-3-135HA08-HP374	30404053
8,50	10	142	95	80	40	SCD221-0850-2-3-135HA08-HP374	30404058
9,00	10	142	95	80	40	SCD221-0900-2-3-135HA08-HP374	30404063
9,30	10	142	95	80	40	SCD221-0930-2-3-135HA08-HP374	30404066
9,50	10	142	95	80	40	SCD221-0950-2-3-135HA08-HP374	30404068
9,60	10	142	95	80	40	SCD221-0960-2-3-135HA08-HP374	30404069
9,80	10	142	95	80	40	SCD221-0980-2-3-135HA08-HP374	30404071
10,00	10	142	95	80	40	SCD221-1000-2-3-135HA08-HP374	30404073
10,20	12	162	114	96	45	SCD221-1020-2-3-135HA08-HP374	30404075

MEGA-Speed-Drill-Uni | Solid carbide twist drill SCD221 (8xD), internal coolant supply

Dimensions						Shank form HA	
d ₁ h7	d ₂ h6	l ₁	l ₂	l ₃	l ₄	Specification	Order no.
10,50	12	162	114	96	45	SCD221-1050-2-3-135HA08-HP374	30404078
11,00	12	162	114	96	45	SCD221-1100-2-3-135HA08-HP374	30404083
11,40	12	162	114	96	45	SCD221-1140-2-3-135HA08-HP374	30404088
11,80	12	162	114	96	45	SCD221-1180-2-3-135HA08-HP374	30404092
12,00	12	162	114	96	45	SCD221-1200-2-3-135HA08-HP374	30404094
12,50	14	178	133	112	45	SCD221-1250-2-3-135HA08-HP374	30404095
13,00	14	178	133	112	45	SCD221-1300-2-3-135HA08-HP374	30404097
13,50	14	178	133	112	45	SCD221-1350-2-3-135HA08-HP374	30404098
14,00	14	178	133	112	45	SCD221-1400-2-3-135HA08-HP374	30404100
15,00	16	203	152	128	48	SCD221-1500-2-3-135HA08-HP374	30404103
16,00	16	203	152	128	48	SCD221-1600-2-3-135HA08-HP374	30404106
17,50	18	222	171	144	48	SCD221-1750-2-3-135HA08-HP374	30404110

Configurable features



Diameter:
Diameter in increments of
0.01 mm freely selectable



Shank form:
Shank form: HB | HE

Specification:

SCD221-[diameter]-3-3-140[shank form]08-HP374

Dimensions of configurable series

d ₁ min.	d ₁ max.	d ₂ h6	l ₁	l ₂	l ₃	l ₄
3,00	3,70	6	72	34	29	36
3,71	4,70	6	81	43	36	36
4,80	6,00	6	95	57	48	36
6,01	8,00	8	114	76	64	36
8,01	10,00	10	142	95	80	40
10,01	12,00	12	162	114	96	45
12,01	14,00	14	178	133	112	45
14,01	16,00	16	203	152	128	48
16,01	18,00	18	222	171	144	48
18,01	20,00	20	243	190	160	50

Example:

SCD221-0431-3-3-140HE08-HP374

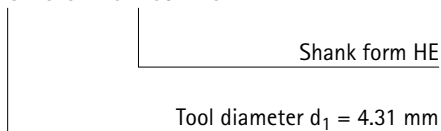

Dimensions in mm.

For cutting data recommendations, see end of chapter.

Special designs and other coatings available upon request.

ECU Drill Uni

Solid carbide twist drill
SCD351 (4xD), internal coolant supply

Design:

Drill diameter: 3.00 - 20.00 mm
Bore tolerance: ≥ IT 9
Cutting material: HP765
Number of cutting edges: 2
Tip angle: 140°
Helix angle: 30°

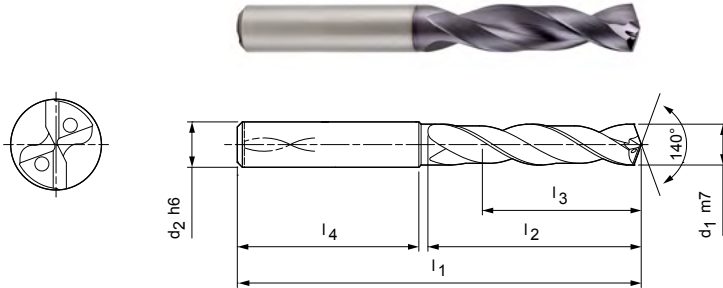

Stocked preferred series in shank form HA

Dimensions						Shank form HA	
d ₁ m7	d ₂ h6	l ₁	l ₂	l ₃	l ₄	Specification	Order no.
3,00	6	62	22	16	36	SCD351-0300-2-2-140HA04-HP765	30421828
3,10	6	62	22	16	36	SCD351-0310-2-2-140HA04-HP765	30421829
3,20	6	62	22	16	36	SCD351-0320-2-2-140HA04-HP765	30421830
3,30	6	62	22	16	36	SCD351-0330-2-2-140HA04-HP765	30421831
3,40	6	62	22	16	36	SCD351-0340-2-2-140HA04-HP765	30421832
3,50	6	62	22	16	36	SCD351-0350-2-2-140HA04-HP765	30421833
3,60	6	62	22	16	36	SCD351-0360-2-2-140HA04-HP765	30421834
3,70*	6	62	22	16	36	SCD351-0370-2-2-140HA04-HP765	30421835
3,80	6	66	26	22	36	SCD351-0380-2-2-140HA04-HP765	30421836
3,90	6	66	26	22	36	SCD351-0390-2-2-140HA04-HP765	30421837
4,00	6	66	26	22	36	SCD351-0400-2-2-140HA04-HP765	30421838
4,10	6	66	26	22	36	SCD351-0410-2-2-140HA04-HP765	30421839
4,20	6	66	26	22	36	SCD351-0420-2-2-140HA04-HP765	30421840
4,30	6	66	26	22	36	SCD351-0430-2-2-140HA04-HP765	30421842
4,40	6	66	26	22	36	SCD351-0440-2-2-140HA04-HP765	30421843
4,50	6	66	26	22	36	SCD351-0450-2-2-140HA04-HP765	30421844
4,60	6	66	26	22	36	SCD351-0460-2-2-140HA04-HP765	30421845
4,65*	6	66	26	22	36	SCD351-0465-2-2-140HA04-HP765	30421846
4,70	6	66	26	22	36	SCD351-0470-2-2-140HA04-HP765	30421847
4,80	6	66	30	24	36	SCD351-0480-2-2-140HA04-HP765	30421848
4,90	6	66	30	24	36	SCD351-0490-2-2-140HA04-HP765	30421849
5,00	6	66	30	24	36	SCD351-0500-2-2-140HA04-HP765	30421850
5,10	6	66	30	24	36	SCD351-0510-2-2-140HA04-HP765	30421851
5,20	6	66	30	24	36	SCD351-0520-2-2-140HA04-HP765	30421852
5,30	6	66	30	24	36	SCD351-0530-2-2-140HA04-HP765	30421853
5,40	6	66	30	24	36	SCD351-0540-2-2-140HA04-HP765	30421854
5,50	6	66	30	24	36	SCD351-0550-2-2-140HA04-HP765	30421855
5,55*	6	66	30	24	36	SCD351-0555-2-2-140HA04-HP765	30421856
5,60	6	66	30	24	36	SCD351-0560-2-2-140HA04-HP765	30421857
5,70	6	66	30	24	36	SCD351-0570-2-2-140HA04-HP765	30421858
5,80	6	66	30	24	36	SCD351-0580-2-2-140HA04-HP765	30421859
5,90	6	66	30	24	36	SCD351-0590-2-2-140HA04-HP765	30421860
6,00	6	66	30	24	36	SCD351-0600-2-2-140HA04-HP765	30421861
6,10	8	79	38	30	36	SCD351-0610-2-2-140HA04-HP765	30421862

ECU-Drill-Uni | Solid carbide twist drill SCD351 (4xD), internal coolant supply

Dimensions						Shank form HA	
d ₁ m7	d ₂ h6	l ₁	l ₂	l ₃	l ₄	Specification	Order no.
6,20	8	79	38	30	36	SCD351-0620-2-2-140HA04-HP765	30421863
6,30	8	79	38	30	36	SCD351-0630-2-2-140HA04-HP765	30421864
6,40	8	79	38	30	36	SCD351-0640-2-2-140HA04-HP765	30421865
6,50	8	79	38	30	36	SCD351-0650-2-2-140HA04-HP765	30421866
6,60	8	79	38	30	36	SCD351-0660-2-2-140HA04-HP765	30421867
6,70	8	79	38	30	36	SCD351-0670-2-2-140HA04-HP765	30421868
6,80	8	79	38	30	36	SCD351-0680-2-2-140HA04-HP765	30421869
6,90	8	79	38	30	36	SCD351-0690-2-2-140HA04-HP765	30421870
7,00	8	79	38	30	36	SCD351-0700-2-2-140HA04-HP765	30421871
7,10	8	79	42	34	36	SCD351-0710-2-2-140HA04-HP765	30421872
7,20	8	79	42	34	36	SCD351-0720-2-2-140HA04-HP765	30421873
7,30	8	79	42	34	36	SCD351-0730-2-2-140HA04-HP765	30421874
7,40	8	79	42	34	36	SCD351-0740-2-2-140HA04-HP765	30421875
7,45*	8	79	42	34	36	SCD351-0745-2-2-140HA04-HP765	30569196
7,50	8	79	42	34	36	SCD351-0750-2-2-140HA04-HP765	30421876
7,60	8	79	42	34	36	SCD351-0760-2-2-140HA04-HP765	30421878
7,70	8	79	42	34	36	SCD351-0770-2-2-140HA04-HP765	30421879
7,80	8	79	42	34	36	SCD351-0780-2-2-140HA04-HP765	30421880
7,90	8	79	42	34	36	SCD351-0790-2-2-140HA04-HP765	30421881
8,00	8	79	42	34	36	SCD351-0800-2-2-140HA04-HP765	30421882
8,10	10	89	49	38	40	SCD351-0810-2-2-140HA04-HP765	30421883
8,20	10	89	49	38	40	SCD351-0820-2-2-140HA04-HP765	30421884
8,30	10	89	49	38	40	SCD351-0830-2-2-140HA04-HP765	30421885
8,40	10	89	49	38	40	SCD351-0840-2-2-140HA04-HP765	30421886
8,50	10	89	49	38	40	SCD351-0850-2-2-140HA04-HP765	30421887
8,60	10	89	49	38	40	SCD351-0860-2-2-140HA04-HP765	30421888
8,70	10	89	49	38	40	SCD351-0870-2-2-140HA04-HP765	30421889
8,80	10	89	49	38	40	SCD351-0880-2-2-140HA04-HP765	30421890
8,90	10	89	49	38	40	SCD351-0890-2-2-140HA04-HP765	30421891
9,00	10	89	49	38	40	SCD351-0900-2-2-140HA04-HP765	30421892
9,10	10	89	49	38	40	SCD351-0910-2-2-140HA04-HP765	30421893
9,20	10	89	49	38	40	SCD351-0920-2-2-140HA04-HP765	30421894
9,30*	10	89	49	40	40	SCD351-0930-2-2-140HA04-HP765	30421896
9,40	10	89	49	40	40	SCD351-0940-2-2-140HA04-HP765	30421897
9,50	10	89	49	40	40	SCD351-0950-2-2-140HA04-HP765	30421898
9,60	10	89	49	40	40	SCD351-0960-2-2-140HA04-HP765	30421899
9,70	10	89	49	40	40	SCD351-0970-2-2-140HA04-HP765	30421900
9,80	10	89	49	40	40	SCD351-0980-2-2-140HA04-HP765	30421901
9,90	10	89	49	40	40	SCD351-0990-2-2-140HA04-HP765	30421902
10,00	10	89	49	40	40	SCD351-1000-2-2-140HA04-HP765	30421903
10,10	12	102	56	45	45	SCD351-1010-2-2-140HA04-HP765	30421904
10,20	12	102	56	45	45	SCD351-1020-2-2-140HA04-HP765	30421905
10,30	12	102	56	45	45	SCD351-1030-2-2-140HA04-HP765	30421906
10,40	12	102	56	45	45	SCD351-1040-2-2-140HA04-HP765	30421907
10,50	12	102	56	45	45	SCD351-1050-2-2-140HA04-HP765	30421908
10,60	12	102	56	45	45	SCD351-1060-2-2-140HA04-HP765	30421909
10,70	12	102	56	45	45	SCD351-1070-2-2-140HA04-HP765	30421910
10,80	12	102	56	45	45	SCD351-1080-2-2-140HA04-HP765	30421911
10,90	12	102	56	45	45	SCD351-1090-2-2-140HA04-HP765	30421912
11,00	12	102	56	45	45	SCD351-1100-2-2-140HA04-HP765	30421913
11,10	12	102	56	45	45	SCD351-1110-2-2-140HA04-HP765	30421914
11,20*	12	102	56	45	45	SCD351-1120-2-2-140HA04-HP765	30421915
11,50	12	102	56	45	45	SCD351-1150-2-2-140HA04-HP765	30421918
11,70	12	102	56	45	45	SCD351-1170-2-2-140HA04-HP765	30421920
11,80	12	102	56	45	45	SCD351-1180-2-2-140HA04-HP765	30421921

Continued on next page.

ECU-Drill-Uni | Solid carbide twist drill SCD351 (4xD), internal coolant supply

Dimensions						Shank form HA	
d ₁ m7	d ₂ h6	l ₁	l ₂	l ₃	l ₄	Specification	Order no.
11,90	12	102	56	45	45	SCD351-1190-2-2-140HA04-HP765	30421922
12,00	12	102	56	45	45	SCD351-1200-2-2-140HA04-HP765	30421923
12,20	14	107	61	50	45	SCD351-1220-2-2-140HA04-HP765	30421924
12,50	14	107	61	50	45	SCD351-1250-2-2-140HA04-HP765	30421925
12,70	14	107	61	50	45	SCD351-1270-2-2-140HA04-HP765	30421926
12,80	14	107	61	50	45	SCD351-1280-2-2-140HA04-HP765	30421927
13,00	14	107	61	50	45	SCD351-1300-2-2-140HA04-HP765	30421928
13,50	14	107	61	50	45	SCD351-1350-2-2-140HA04-HP765	30421929
13,80	14	107	61	50	45	SCD351-1380-2-2-140HA04-HP765	30421931
14,00	14	107	61	50	45	SCD351-1400-2-2-140HA04-HP765	30421932
14,20	16	115	65	51	48	SCD351-1420-2-2-140HA04-HP765	30421934
14,50	16	115	65	51	48	SCD351-1450-2-2-140HA04-HP765	30421935
14,80	16	115	65	51	48	SCD351-1480-2-2-140HA04-HP765	30421936
15,00	16	115	65	51	48	SCD351-1500-2-2-140HA04-HP765	30421937
15,10	16	115	65	51	48	SCD351-1510-2-2-140HA04-HP765	30421938
15,20	16	115	65	51	48	SCD351-1520-2-2-140HA04-HP765	30421939
15,50	16	115	65	51	48	SCD351-1550-2-2-140HA04-HP765	30421941
15,70	16	115	65	51	48	SCD351-1570-2-2-140HA04-HP765	30421942
15,80	16	115	65	51	48	SCD351-1580-2-2-140HA04-HP765	30421943
16,00	16	115	65	51	48	SCD351-1600-2-2-140HA04-HP765	30421944
16,50	18	123	73	53	48	SCD351-1650-2-2-140HA04-HP765	30421946
16,80	18	123	73	53	48	SCD351-1680-2-2-140HA04-HP765	30569199
17,00	18	123	73	53	48	SCD351-1700-2-2-140HA04-HP765	30421947
17,30	18	123	73	53	48	SCD351-1730-2-2-140HA04-HP765	30421949
17,50	18	123	73	53	48	SCD351-1750-2-2-140HA04-HP765	30421950
17,70	18	123	73	53	48	SCD351-1770-2-2-140HA04-HP765	30421951
18,00	18	123	73	53	48	SCD351-1800-2-2-140HA04-HP765	30421952
18,50	20	131	79	55	50	SCD351-1850-2-2-140HA04-HP765	30421953
19,00	20	131	79	55	50	SCD351-1900-2-2-140HA04-HP765	30421954
19,50	20	131	79	55	50	SCD351-1950-2-2-140HA04-HP765	30421956
20,00	20	131	79	55	50	SCD351-2000-2-2-140HA04-HP765	30421957

Configurable features



Shank form:
Shank form: HB | HE



Specification:
SCD351-0430-3-3-140[shank form]04-HP765

Example:
SCD351-0430-3-3-140HE04-HP765

Shank form HE

Dimensions in mm.

* Particularly suitable for the premanufacturing of core bores for thread formers.

For cutting data recommendations, see end of chapter.

Special designs and other coatings available upon request.

ECU-Drill-Uni

Solid carbide twist drill
SCD350 (4xD), external coolant supply

Design:
 Drill diameter: 3.00 - 20.00 mm
 Bore tolerance: \geq IT 9
 Cutting material: HP765
 Number of cutting edges: 2
 Tip angle: 140°
 Helix angle: 30°

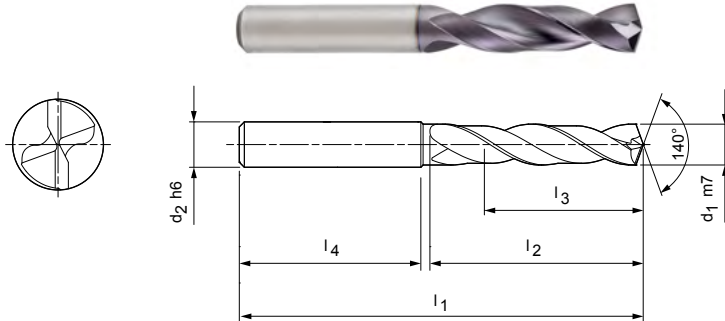

Stocked preferred series in shank form HA

Dimensions						Shank form HA	
d ₁ m7	d ₂ h6	l ₁	l ₂	l ₃	l ₄	Specification	Order no.
3,00	6	62	22	16	36	SCD350-0300-2-2-140HA04-HP765	30421694
3,10	6	62	22	16	36	SCD350-0310-2-2-140HA04-HP765	30421696
3,20	6	62	22	16	36	SCD350-0320-2-2-140HA04-HP765	30421697
3,30	6	62	22	16	36	SCD350-0330-2-2-140HA04-HP765	30421698
3,40	6	62	22	16	36	SCD350-0340-2-2-140HA04-HP765	30421699
3,50	6	62	22	16	36	SCD350-0350-2-2-140HA04-HP765	30421700
3,60	6	62	22	16	36	SCD350-0360-2-2-140HA04-HP765	30421701
3,70*	6	62	22	16	36	SCD350-0370-2-2-140HA04-HP765	30421703
3,80	6	66	26	22	36	SCD350-0380-2-2-140HA04-HP765	30421704
3,90	6	66	26	22	36	SCD350-0390-2-2-140HA04-HP765	30421705
4,00	6	66	26	22	36	SCD350-0400-2-2-140HA04-HP765	30421706
4,10	6	66	26	22	36	SCD350-0410-2-2-140HA04-HP765	30421707
4,20	6	66	26	22	36	SCD350-0420-2-2-140HA04-HP765	30421708
4,30	6	66	26	22	36	SCD350-0430-2-2-140HA04-HP765	30421709
4,40	6	66	26	22	36	SCD350-0440-2-2-140HA04-HP765	30421710
4,50	6	66	26	22	36	SCD350-0450-2-2-140HA04-HP765	30421711
4,60	6	66	26	22	36	SCD350-0460-2-2-140HA04-HP765	30421712
4,65*	6	66	26	22	36	SCD350-0465-2-2-140HA04-HP765	30421713
4,70	6	66	26	22	36	SCD350-0470-2-2-140HA04-HP765	30421714
4,80	6	66	30	24	36	SCD350-0480-2-2-140HA04-HP765	30421715
4,90	6	66	30	24	36	SCD350-0490-2-2-140HA04-HP765	30421716
5,00	6	66	30	24	36	SCD350-0500-2-2-140HA04-HP765	30421717
5,10	6	66	30	24	36	SCD350-0510-2-2-140HA04-HP765	30421718
5,20	6	66	30	24	36	SCD350-0520-2-2-140HA04-HP765	30421719
5,30	6	66	30	24	36	SCD350-0530-2-2-140HA04-HP765	30421720
5,40	6	66	30	24	36	SCD350-0540-2-2-140HA04-HP765	30421721
5,50	6	66	30	24	36	SCD350-0550-2-2-140HA04-HP765	30421722
5,55*	6	66	30	24	36	SCD350-0555-2-2-140HA04-HP765	30421723
5,60	6	66	30	24	36	SCD350-0560-2-2-140HA04-HP765	30421725
5,70	6	66	30	24	36	SCD350-0570-2-2-140HA04-HP765	30421726
5,80	6	66	30	24	36	SCD350-0580-2-2-140HA04-HP765	30421727
5,90	6	66	30	24	36	SCD350-0590-2-2-140HA04-HP765	30421728
6,00	6	66	30	24	36	SCD350-0600-2-2-140HA04-HP765	30421731
6,10	8	79	38	30	36	SCD350-0610-2-2-140HA04-HP765	30421732

ECU-Drill-Uni | Solid carbide twist drill SCD350 (4xD), external coolant supply

Dimensions						Shank form HA	
d ₁ m7	d ₂ h6	l ₁	l ₂	l ₃	l ₄	Specification	Order no.
6,20	8	79	38	30	36	SCD350-0620-2-2-140HA04-HP765	30421733
6,30	8	79	38	30	36	SCD350-0630-2-2-140HA04-HP765	30421734
6,40	8	79	38	30	36	SCD350-0640-2-2-140HA04-HP765	30421735
6,50	8	79	38	30	36	SCD350-0650-2-2-140HA04-HP765	30421736
6,60	8	79	38	30	36	SCD350-0660-2-2-140HA04-HP765	30421737
6,70	8	79	38	30	36	SCD350-0670-2-2-140HA04-HP765	30421738
6,80	8	79	38	30	36	SCD350-0680-2-2-140HA04-HP765	30421739
6,90	8	79	38	30	36	SCD350-0690-2-2-140HA04-HP765	30421740
7,00	8	79	38	30	36	SCD350-0700-2-2-140HA04-HP765	30421741
7,10	8	79	42	34	36	SCD350-0710-2-2-140HA04-HP765	30421742
7,20	8	79	42	34	36	SCD350-0720-2-2-140HA04-HP765	30421743
7,30	8	79	42	34	36	SCD350-0730-2-2-140HA04-HP765	30421744
7,40	8	79	42	34	36	SCD350-0740-2-2-140HA04-HP765	30421745
7,50	8	79	42	34	36	SCD350-0750-2-2-140HA04-HP765	30421746
7,60	8	79	42	34	36	SCD350-0760-2-2-140HA04-HP765	30421748
7,70	8	79	42	34	36	SCD350-0770-2-2-140HA04-HP765	30421749
7,80	8	79	42	34	36	SCD350-0780-2-2-140HA04-HP765	30421750
7,90	8	79	42	34	36	SCD350-0790-2-2-140HA04-HP765	30421751
8,00	8	79	42	34	36	SCD350-0800-2-2-140HA04-HP765	30421752
8,10	10	89	49	38	40	SCD350-0810-2-2-140HA04-HP765	30421753
8,20	10	89	49	38	40	SCD350-0820-2-2-140HA04-HP765	30421754
8,30	10	89	49	38	40	SCD350-0830-2-2-140HA04-HP765	30421755
8,40	10	89	49	38	40	SCD350-0840-2-2-140HA04-HP765	30421756
8,50	10	89	49	38	40	SCD350-0850-2-2-140HA04-HP765	30421757
8,60	10	89	49	38	40	SCD350-0860-2-2-140HA04-HP765	30421758
8,70	10	89	49	38	40	SCD350-0870-2-2-140HA04-HP765	30421759
8,80	10	89	49	38	40	SCD350-0880-2-2-140HA04-HP765	30421760
8,90	10	89	49	38	40	SCD350-0890-2-2-140HA04-HP765	30421761
9,00	10	89	49	38	40	SCD350-0900-2-2-140HA04-HP765	30421762
9,10	10	89	49	38	40	SCD350-0910-2-2-140HA04-HP765	30421763
9,20	10	89	49	38	40	SCD350-0920-2-2-140HA04-HP765	30421764
9,30*	10	89	49	40	40	SCD350-0930-2-2-140HA04-HP765	30421766
9,40	10	89	49	40	40	SCD350-0940-2-2-140HA04-HP765	30421767
9,50	10	89	49	40	40	SCD350-0950-2-2-140HA04-HP765	30421768
9,60	10	89	49	40	40	SCD350-0960-2-2-140HA04-HP765	30421769
9,70	10	89	49	40	40	SCD350-0970-2-2-140HA04-HP765	30421770
9,80	10	89	49	40	40	SCD350-0980-2-2-140HA04-HP765	30421771
9,90	10	89	49	40	40	SCD350-0990-2-2-140HA04-HP765	30421772
10,00	10	89	49	40	40	SCD350-1000-2-2-140HA04-HP765	30421773
10,10	12	102	56	45	45	SCD350-1010-2-2-140HA04-HP765	30421774
10,20	12	102	56	45	45	SCD350-1020-2-2-140HA04-HP765	30421775
10,30	12	102	56	45	45	SCD350-1030-2-2-140HA04-HP765	30421776
10,40	12	102	56	45	45	SCD350-1040-2-2-140HA04-HP765	30421777
10,50	12	102	56	45	45	SCD350-1050-2-2-140HA04-HP765	30421778
10,60	12	102	56	45	45	SCD350-1060-2-2-140HA04-HP765	30421779
10,80	12	102	56	45	45	SCD350-1080-2-2-140HA04-HP765	30421781
10,90	12	102	56	45	45	SCD350-1090-2-2-140HA04-HP765	30421782
11,00	12	102	56	45	45	SCD350-1100-2-2-140HA04-HP765	30421783
11,10	12	102	56	45	45	SCD350-1110-2-2-140HA04-HP765	30421784
11,20*	12	102	56	45	45	SCD350-1120-2-2-140HA04-HP765	30421785
11,30	12	102	56	45	45	SCD350-1130-2-2-140HA04-HP765	30421786
11,40	12	102	56	45	45	SCD350-1140-2-2-140HA04-HP765	30421787
11,50	12	102	56	45	45	SCD350-1150-2-2-140HA04-HP765	30421788
11,60	12	102	56	45	45	SCD350-1160-2-2-140HA04-HP765	30421789
11,70	12	102	56	45	45	SCD350-1170-2-2-140HA04-HP765	30421790

ECU-Drill-Uni | Solid carbide twist drill SCD350 (4xD), external coolant supply

Dimensions						Shank form HA	
d ₁ m7	d ₂ h6	l ₁	l ₂	l ₃	l ₄	Specification	Order no.
11,80	12	102	56	45	45	SCD350-1180-2-2-140HA04-HP765	30421791
12,00	12	102	56	45	45	SCD350-1200-2-2-140HA04-HP765	30421793
12,20	14	107	61	50	45	SCD350-1220-2-2-140HA04-HP765	30421794
12,50	14	107	61	50	45	SCD350-1250-2-2-140HA04-HP765	30421795
12,80	14	107	61	50	45	SCD350-1280-2-2-140HA04-HP765	30421798
13,00	14	107	61	50	45	SCD350-1300-2-2-140HA04-HP765	30421799
13,50	14	107	61	50	45	SCD350-1350-2-2-140HA04-HP765	30421800
13,80	14	107	61	50	45	SCD350-1380-2-2-140HA04-HP765	30421802
14,00	14	107	61	50	45	SCD350-1400-2-2-140HA04-HP765	30421803
14,20	16	115	65	51	48	SCD350-1420-2-2-140HA04-HP765	30421804
14,50	16	115	65	51	48	SCD350-1450-2-2-140HA04-HP765	30421805
14,80	16	115	65	51	48	SCD350-1480-2-2-140HA04-HP765	30421807
15,00	16	115	65	51	48	SCD350-1500-2-2-140HA04-HP765	30421808
15,10	16	115	65	51	48	SCD350-1510-2-2-140HA04-HP765	30421809
15,20	16	115	65	51	48	SCD350-1520-2-2-140HA04-HP765	30421810
15,50	16	115	65	51	48	SCD350-1550-2-2-140HA04-HP765	30421811
15,70	16	115	65	51	48	SCD350-1570-2-2-140HA04-HP765	30421813
15,80	16	115	65	51	48	SCD350-1580-2-2-140HA04-HP765	30421814
16,00	16	115	65	51	48	SCD350-1600-2-2-140HA04-HP765	30421815
16,50	18	123	73	53	48	SCD350-1650-2-2-140HA04-HP765	30421817
17,00	18	123	73	53	48	SCD350-1700-2-2-140HA04-HP765	30421818
17,50	18	123	73	53	48	SCD350-1750-2-2-140HA04-HP765	30421820
17,70	18	123	73	53	48	SCD350-1770-2-2-140HA04-HP765	30421821
18,00	18	123	73	53	48	SCD350-1800-2-2-140HA04-HP765	30421822
18,50	20	131	79	55	50	SCD350-1850-2-2-140HA04-HP765	30421823
19,00	20	131	79	55	50	SCD350-1900-2-2-140HA04-HP765	30421824
19,50	20	131	79	55	50	SCD350-1950-2-2-140HA04-HP765	30421826
20,00	20	131	79	55	50	SCD350-2000-2-2-140HA04-HP765	30421827

Configurable features



Shank form:
Shank form: HB | HE

**Specification:**

SCD350-0430-3-3-140[shank form]04-HP765

Example:

SCD350-0430-3-3-140HE04-HP765

Shank form HE

Dimensions in mm.

* Particularly suitable for the premanufacturing of core bores for thread formers.

For cutting data recommendations, see end of chapter.

Special designs and other coatings available upon request.

ECU-Drill-Uni

Solid carbide twist drill
SCD351 (6xD), internal coolant supply

Design:

Drill diameter: 3.00 - 20.00 mm
Bore tolerance: \geq IT 9
Cutting material: HP765
Number of cutting edges: 2
Tip angle: 140°
Helix angle: 30°

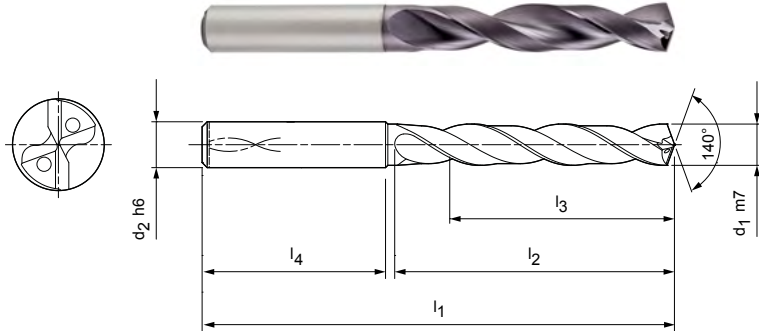

Stocked preferred series in shank form HA

Dimensions						Shank form HA	
d ₁ m7	d ₂ h6	l ₁	l ₂	l ₃	l ₄	Specification	Order no.
3,00	6	66	28	23	36	SCD351-0300-2-2-140HA06-HP765	30421958
3,10	6	66	28	23	36	SCD351-0310-2-2-140HA06-HP765	30421959
3,20	6	66	28	23	36	SCD351-0320-2-2-140HA06-HP765	30421960
3,30	6	66	28	23	36	SCD351-0330-2-2-140HA06-HP765	30421961
3,40	6	66	28	23	36	SCD351-0340-2-2-140HA06-HP765	30421962
3,50	6	66	28	23	36	SCD351-0350-2-2-140HA06-HP765	30421963
3,60	6	66	28	23	36	SCD351-0360-2-2-140HA06-HP765	30421964
3,70*	6	66	28	23	36	SCD351-0370-2-2-140HA06-HP765	30421965
3,80	6	74	36	29	36	SCD351-0380-2-2-140HA06-HP765	30421966
3,90	6	74	36	29	36	SCD351-0390-2-2-140HA06-HP765	30421967
4,00	6	74	36	29	36	SCD351-0400-2-2-140HA06-HP765	30421968
4,10	6	74	36	29	36	SCD351-0410-2-2-140HA06-HP765	30421969
4,20	6	74	36	29	36	SCD351-0420-2-2-140HA06-HP765	30421970
4,30	6	74	36	29	36	SCD351-0430-2-2-140HA06-HP765	30421971
4,40	6	74	36	29	36	SCD351-0440-2-2-140HA06-HP765	30421972
4,50	6	74	36	29	36	SCD351-0450-2-2-140HA06-HP765	30421973
4,60	6	74	36	29	36	SCD351-0460-2-2-140HA06-HP765	30421974
4,65*	6	74	36	29	36	SCD351-0465-2-2-140HA06-HP765	30421975
4,70	6	74	36	29	36	SCD351-0470-2-2-140HA06-HP765	30421976
4,80	6	82	44	35	36	SCD351-0480-2-2-140HA06-HP765	30421977
4,90	6	82	44	35	36	SCD351-0490-2-2-140HA06-HP765	30421978
5,00	6	82	44	35	36	SCD351-0500-2-2-140HA06-HP765	30421979
5,10	6	82	44	35	36	SCD351-0510-2-2-140HA06-HP765	30421980
5,20	6	82	44	35	36	SCD351-0520-2-2-140HA06-HP765	30421981
5,30	6	82	44	35	36	SCD351-0530-2-2-140HA06-HP765	30421982
5,40	6	82	44	35	36	SCD351-0540-2-2-140HA06-HP765	30421983
5,50	6	82	44	35	36	SCD351-0550-2-2-140HA06-HP765	30421984
5,55*	6	82	44	35	36	SCD351-0555-2-2-140HA06-HP765	30421985
5,60	6	82	44	35	36	SCD351-0560-2-2-140HA06-HP765	30421987
5,70	6	82	44	35	36	SCD351-0570-2-2-140HA06-HP765	30421988
5,80	6	82	44	35	36	SCD351-0580-2-2-140HA06-HP765	30421989
5,90	6	82	44	35	36	SCD351-0590-2-2-140HA06-HP765	30421990
6,00	6	82	44	35	36	SCD351-0600-2-2-140HA06-HP765	30421991
6,10	8	91	53	43	36	SCD351-0610-2-2-140HA06-HP765	30421992
6,20	8	91	53	43	36	SCD351-0620-2-2-140HA06-HP765	30421993

ECU-Drill-Uni | Solid carbide twist drill SCD351 (6xD), internal coolant supply

Dimensions						Shank form HA	
d ₁ m7	d ₂ h6	l ₁	l ₂	l ₃	l ₄	Specification	Order no.
6,30	8	91	53	43	36	SCD351-0630-2-2-140HA06-HP765	30421994
6,40	8	91	53	43	36	SCD351-0640-2-2-140HA06-HP765	30421995
6,50	8	91	53	43	36	SCD351-0650-2-2-140HA06-HP765	30421996
6,60	8	91	53	43	36	SCD351-0660-2-2-140HA06-HP765	30421997
6,70	8	91	53	43	36	SCD351-0670-2-2-140HA06-HP765	30421998
6,80	8	91	53	43	36	SCD351-0680-2-2-140HA06-HP765	30421999
6,90	8	91	53	43	36	SCD351-0690-2-2-140HA06-HP765	30422000
7,00	8	91	53	43	36	SCD351-0700-2-2-140HA06-HP765	30422001
7,10	8	91	53	43	36	SCD351-0710-2-2-140HA06-HP765	30422002
7,20	8	91	53	43	36	SCD351-0720-2-2-140HA06-HP765	30422003
7,30	8	91	53	43	36	SCD351-0730-2-2-140HA06-HP765	30422004
7,40	8	91	53	43	36	SCD351-0740-2-2-140HA06-HP765	30422005
7,45*	8	91	53	43	36	SCD351-0745-2-2-140HA06-HP765	30569230
7,50	8	91	53	43	36	SCD351-0750-2-2-140HA06-HP765	30422006
7,60	8	91	53	43	36	SCD351-0760-2-2-140HA06-HP765	30422008
7,70	8	91	53	43	36	SCD351-0770-2-2-140HA06-HP765	30422009
7,80	8	91	53	43	36	SCD351-0780-2-2-140HA06-HP765	30422010
7,90	8	91	53	43	36	SCD351-0790-2-2-140HA06-HP765	30422011
8,00	8	91	53	43	36	SCD351-0800-2-2-140HA06-HP765	30422012
8,10	10	103	61	49	40	SCD351-0810-2-2-140HA06-HP765	30422013
8,20	10	103	61	49	40	SCD351-0820-2-2-140HA06-HP765	30422014
8,30	10	103	61	49	40	SCD351-0830-2-2-140HA06-HP765	30422015
8,40	10	103	61	49	40	SCD351-0840-2-2-140HA06-HP765	30422016
8,50	10	103	61	49	40	SCD351-0850-2-2-140HA06-HP765	30422017
8,60	10	103	61	49	40	SCD351-0860-2-2-140HA06-HP765	30422018
8,70	10	103	61	49	40	SCD351-0870-2-2-140HA06-HP765	30422019
8,80	10	103	61	49	40	SCD351-0880-2-2-140HA06-HP765	30422020
8,90	10	103	61	49	40	SCD351-0890-2-2-140HA06-HP765	30422021
9,00	10	103	61	49	40	SCD351-0900-2-2-140HA06-HP765	30422022
9,10	10	103	61	49	40	SCD351-0910-2-2-140HA06-HP765	30422023
9,20	10	103	61	49	40	SCD351-0920-2-2-140HA06-HP765	30422024
9,30*	10	103	61	49	40	SCD351-0930-2-2-140HA06-HP765	30422026
9,40	10	103	61	49	40	SCD351-0940-2-2-140HA06-HP765	30422027
9,50	10	103	61	49	40	SCD351-0950-2-2-140HA06-HP765	30422028
9,60	10	103	61	49	40	SCD351-0960-2-2-140HA06-HP765	30422029
9,70	10	103	61	49	40	SCD351-0970-2-2-140HA06-HP765	30422030
9,80	10	103	61	49	40	SCD351-0980-2-2-140HA06-HP765	30422031
9,90	10	103	61	49	40	SCD351-0990-2-2-140HA06-HP765	30422032
10,00	10	103	61	49	40	SCD351-1000-2-2-140HA06-HP765	30422033
10,10	12	118	71	56	45	SCD351-1010-2-2-140HA06-HP765	30422034
10,20	12	118	71	56	45	SCD351-1020-2-2-140HA06-HP765	30422035
10,30	12	118	71	56	45	SCD351-1030-2-2-140HA06-HP765	30422036
10,40	12	118	71	56	45	SCD351-1040-2-2-140HA06-HP765	30422037
10,50	12	118	71	56	45	SCD351-1050-2-2-140HA06-HP765	30422038
10,60	12	118	71	56	45	SCD351-1060-2-2-140HA06-HP765	30422039
10,70	12	118	71	56	45	SCD351-1070-2-2-140HA06-HP765	30422040
10,80	12	118	71	56	45	SCD351-1080-2-2-140HA06-HP765	30422041
10,90	12	118	71	56	45	SCD351-1090-2-2-140HA06-HP765	30422042
11,00	12	118	71	56	45	SCD351-1100-2-2-140HA06-HP765	30422043
11,10	12	118	71	56	45	SCD351-1110-2-2-140HA06-HP765	30422044
11,20*	12	118	71	56	45	SCD351-1120-2-2-140HA06-HP765	30422045
11,30	12	118	71	56	45	SCD351-1130-2-2-140HA06-HP765	30422046
11,50	12	118	71	56	45	SCD351-1150-2-2-140HA06-HP765	30422048
11,60	12	118	71	56	45	SCD351-1160-2-2-140HA06-HP765	30422049
11,80	12	118	71	56	45	SCD351-1180-2-2-140HA06-HP765	30422051
11,90	12	118	71	56	45	SCD351-1190-2-2-140HA06-HP765	30422052
12,00	12	118	71	56	45	SCD351-1200-2-2-140HA06-HP765	30422053

Continued on next page.

ECU-Drill-Uni | Solid carbide twist drill SCD351 (6xD), internal coolant supply

Dimensions						Shank form HA	
d ₁ m7	d ₂ h6	l ₁	l ₂	l ₃	l ₄	Specification	Order no.
12,20	14	124	77	60	45	SCD351-1220-2-2-140HA06-HP765	30422054
12,50	14	124	77	60	45	SCD351-1250-2-2-140HA06-HP765	30422055
12,70	14	124	77	60	45	SCD351-1270-2-2-140HA06-HP765	30422056
12,80	14	124	77	60	45	SCD351-1280-2-2-140HA06-HP765	30422057
13,00	14	124	77	60	45	SCD351-1300-2-2-140HA06-HP765	30422058
13,50	14	124	77	60	45	SCD351-1350-2-2-140HA06-HP765	30422059
13,70	14	124	77	60	45	SCD351-1370-2-2-140HA06-HP765	30422060
13,80	14	124	77	60	45	SCD351-1380-2-2-140HA06-HP765	30422061
14,00	14	124	77	60	45	SCD351-1400-2-2-140HA06-HP765	30422062
14,20	16	133	83	63	48	SCD351-1420-2-2-140HA06-HP765	30422063
14,50	16	133	83	63	48	SCD351-1450-2-2-140HA06-HP765	30422064
14,80	16	133	83	63	48	SCD351-1480-2-2-140HA06-HP765	30422066
15,00	16	133	83	63	48	SCD351-1500-2-2-140HA06-HP765	30422067
15,50	16	133	83	63	48	SCD351-1550-2-2-140HA06-HP765	30422069
15,70	16	133	83	63	48	SCD351-1570-2-2-140HA06-HP765	30422070
15,80	16	133	83	63	48	SCD351-1580-2-2-140HA06-HP765	30422071
16,00	16	133	83	63	48	SCD351-1600-2-2-140HA06-HP765	30422072
16,50	18	143	93	71	48	SCD351-1650-2-2-140HA06-HP765	30422073
17,00	18	143	93	71	48	SCD351-1700-2-2-140HA06-HP765	30422074
17,50	18	143	93	71	48	SCD351-1750-2-2-140HA06-HP765	30422075
18,00	18	143	93	71	48	SCD351-1800-2-2-140HA06-HP765	30422076
18,50	20	153	101	77	50	SCD351-1850-2-2-140HA06-HP765	30422077
19,00	20	153	101	77	50	SCD351-1900-2-2-140HA06-HP765	30422078
19,50	20	153	101	77	50	SCD351-1950-2-2-140HA06-HP765	30422079
20,00	20	153	101	77	50	SCD351-2000-2-2-140HA06-HP765	30422080

Configurable features



Shank form:
Shank form: HB | HE



Specification:
SCD351-0430-3-3-140[shank form]06-HP765

Example:
SCD351-0430-3-3-140HE06-HP765

Shank form HE

Dimensions in mm.

* Particularly suitable for the premanufacturing of core bores for thread formers.

For cutting data recommendations, see end of chapter.

Special designs and other coatings available upon request.

MEGA-Drill-Steel-Plus

Solid carbide twist drill

SCD600 (3xD), external coolant supply, follow-up product to the MEGA-Drill-Steel (SCD10)

Design:

- Drill diameter: 3.00 – 25.00 mm
- Bore tolerance: \geq IT 9
- Cutting material: HP358
- Number of cutting edges: 2
- Number of guiding chamfers: 2
- Tip angle: 140°
- Helix angle: 30°

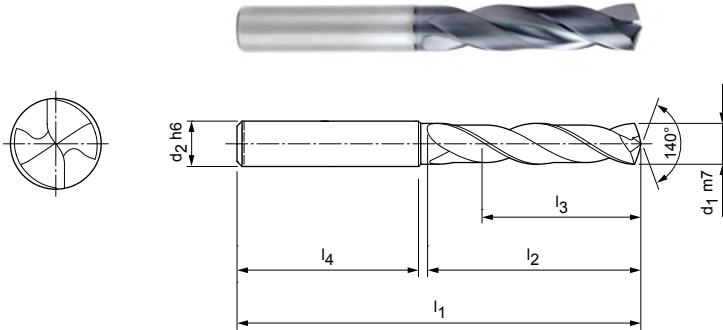

Stocked preferred series in shank form HA

Dimensions						Shank form HA	
d ₁ m7	d ₂ h6	l ₁	l ₂	l ₃	l ₄	Specification	Order no.
3,00	6	62	20	14	36	SCD600-0300-2-2-140HA03-HP358	30801131
3,10	6	62	20	14	36	SCD600-0310-2-2-140HA03-HP358	30801132
3,15	6	62	20	14	36	SCD600-0315-2-2-140HA03-HP358	30801133
3,20	6	62	20	14	36	SCD600-0320-2-2-140HA03-HP358	30801134
3,25	6	62	20	14	36	SCD600-0325-2-2-140HA03-HP358	30801136
3,30	6	62	20	14	36	SCD600-0330-2-2-140HA03-HP358	30801137
3,40	6	62	20	14	36	SCD600-0340-2-2-140HA03-HP358	30801138
3,50	6	62	20	14	36	SCD600-0350-2-2-140HA03-HP358	30801139
3,60	6	62	20	14	36	SCD600-0360-2-2-140HA03-HP358	30801140
3,70*	6	62	20	14	36	SCD600-0370-2-2-140HA03-HP358	30801141
3,80	6	66	24	17	36	SCD600-0380-2-2-140HA03-HP358	30801142
3,85	6	66	24	17	36	SCD600-0385-2-2-140HA03-HP358	30801143
3,90	6	66	24	17	36	SCD600-0390-2-2-140HA03-HP358	30801144
4,00	6	66	24	17	36	SCD600-0400-2-2-140HA03-HP358	30801145
4,10	6	66	24	17	36	SCD600-0410-2-2-140HA03-HP358	30801146
4,20	6	66	24	17	36	SCD600-0420-2-2-140HA03-HP358	30801147
4,25	6	66	24	17	36	SCD600-0425-2-2-140HA03-HP358	30801148
4,30	6	66	24	17	36	SCD600-0430-2-2-140HA03-HP358	30801149
4,35	6	66	24	17	36	SCD600-0435-2-2-140HA03-HP358	30801150
4,40	6	66	24	17	36	SCD600-0440-2-2-140HA03-HP358	30801151
4,45	6	66	24	17	36	SCD600-0445-2-2-140HA03-HP358	30801152
4,50	6	66	24	17	36	SCD600-0450-2-2-140HA03-HP358	30801153
4,60	6	66	24	17	36	SCD600-0460-2-2-140HA03-HP358	30801154
4,65*	6	66	24	17	36	SCD600-0465-2-2-140HA03-HP358	30801155
4,70	6	66	24	17	36	SCD600-0470-2-2-140HA03-HP358	30801156
4,80	6	66	28	20	36	SCD600-0480-2-2-140HA03-HP358	30801157
4,90	6	66	28	20	36	SCD600-0490-2-2-140HA03-HP358	30801158
4,95	6	66	28	20	36	SCD600-0495-2-2-140HA03-HP358	30801159
5,00	6	66	28	20	36	SCD600-0500-2-2-140HA03-HP358	30801160
5,05	6	66	28	20	36	SCD600-0505-2-2-140HA03-HP358	30801161
5,10	6	66	28	20	36	SCD600-0510-2-2-140HA03-HP358	30801162
5,20	6	66	28	20	36	SCD600-0520-2-2-140HA03-HP358	30801163
5,30	6	66	28	20	36	SCD600-0530-2-2-140HA03-HP358	30801164
5,40	6	66	28	20	36	SCD600-0540-2-2-140HA03-HP358	30801165
5,50	6	66	28	20	36	SCD600-0550-2-2-140HA03-HP358	30801166

MEGA-Drill-Steel-Plus | Solid carbide twist drill SCD600 (3xD), external coolant supply

Dimensions						Shank form HA	
d ₁ m7	d ₂ h6	l ₁	l ₂	l ₃	l ₄	Specification	Order no.
5,55*	6	66	28	20	36	SCD600-0555-2-2-140HA03-HP358	30801167
5,60	6	66	28	20	36	SCD600-0560-2-2-140HA03-HP358	30801168
5,70	6	66	28	20	36	SCD600-0570-2-2-140HA03-HP358	30801169
5,75	6	66	28	20	36	SCD600-0575-2-2-140HA03-HP358	30801170
5,80	6	66	28	20	36	SCD600-0580-2-2-140HA03-HP358	30801171
5,90	6	66	28	20	36	SCD600-0590-2-2-140HA03-HP358	30801172
5,95	6	66	28	20	36	SCD600-0595-2-2-140HA03-HP358	30801173
6,00	6	66	28	20	36	SCD600-0600-2-2-140HA03-HP358	30801174
6,10	8	79	34	24	36	SCD600-0610-2-2-140HA03-HP358	30801175
6,20	8	79	34	24	36	SCD600-0620-2-2-140HA03-HP358	30801176
6,30	8	79	34	24	36	SCD600-0630-2-2-140HA03-HP358	30801177
6,40	8	79	34	24	36	SCD600-0640-2-2-140HA03-HP358	30801178
6,50	8	79	34	24	36	SCD600-0650-2-2-140HA03-HP358	30801179
6,60	8	79	34	24	36	SCD600-0660-2-2-140HA03-HP358	30801180
6,70	8	79	34	24	36	SCD600-0670-2-2-140HA03-HP358	30801181
6,80	8	79	34	24	36	SCD600-0680-2-2-140HA03-HP358	30801182
6,90	8	79	34	24	36	SCD600-0690-2-2-140HA03-HP358	30801183
7,00	8	79	34	24	36	SCD600-0700-2-2-140HA03-HP358	30801184
7,10	8	79	41	29	36	SCD600-0710-2-2-140HA03-HP358	30801185
7,20	8	79	41	29	36	SCD600-0720-2-2-140HA03-HP358	30801186
7,30	8	79	41	29	36	SCD600-0730-2-2-140HA03-HP358	30801187
7,40	8	79	41	29	36	SCD600-0740-2-2-140HA03-HP358	30801188
7,45*	8	79	41	29	36	SCD600-0745-2-2-140HA03-HP358	30801189
7,50	8	79	41	29	36	SCD600-0750-2-2-140HA03-HP358	30801190
7,60	8	79	41	29	36	SCD600-0760-2-2-140HA03-HP358	30801191
7,70	8	79	41	29	36	SCD600-0770-2-2-140HA03-HP358	30801192
7,80	8	79	41	29	36	SCD600-0780-2-2-140HA03-HP358	30801193
7,90	8	79	41	29	36	SCD600-0790-2-2-140HA03-HP358	30801194
8,00	8	79	41	29	36	SCD600-0800-2-2-140HA03-HP358	30801195
8,10	10	89	47	35	40	SCD600-0810-2-2-140HA03-HP358	30801196
8,20	10	89	47	35	40	SCD600-0820-2-2-140HA03-HP358	30801197
9,10	10	89	47	35	40	SCD600-0910-2-2-140HA03-HP358	30801206
9,20	10	89	47	35	40	SCD600-0920-2-2-140HA03-HP358	30801207
9,30*	10	89	47	35	40	SCD600-0930-2-2-140HA03-HP358	30801208
9,35	10	89	47	35	40	SCD600-0935-2-2-140HA03-HP358	30801209
9,50	10	89	47	35	40	SCD600-0950-2-2-140HA03-HP358	30801212
9,60	10	89	47	35	40	SCD600-0960-2-2-140HA03-HP358	30801213
9,70	10	89	47	35	40	SCD600-0970-2-2-140HA03-HP358	30801214
9,80	10	89	47	35	40	SCD600-0980-2-2-140HA03-HP358	30801215
9,90	10	89	47	35	40	SCD600-0990-2-2-140HA03-HP358	30801216
10,00	10	89	47	35	40	SCD600-1000-2-2-140HA03-HP358	30801217
10,10	12	102	55	40	45	SCD600-1010-2-2-140HA03-HP358	30801218
10,20	12	102	55	40	45	SCD600-1020-2-2-140HA03-HP358	30801219
10,30	12	102	55	40	45	SCD600-1030-2-2-140HA03-HP358	30801220
10,40	12	102	55	40	45	SCD600-1040-2-2-140HA03-HP358	30801221
10,50	12	102	55	40	45	SCD600-1050-2-2-140HA03-HP358	30801222
10,55	12	102	55	40	45	SCD600-1055-2-2-140HA03-HP358	30801223
10,60	12	102	55	40	45	SCD600-1060-2-2-140HA03-HP358	30801224
10,70	12	102	55	40	45	SCD600-1070-2-2-140HA03-HP358	30801225
10,80	12	102	55	40	45	SCD600-1080-2-2-140HA03-HP358	30801227
10,90	12	102	55	40	45	SCD600-1090-2-2-140HA03-HP358	30801228
11,00	12	102	55	40	45	SCD600-1100-2-2-140HA03-HP358	30801229
11,10	12	102	55	40	45	SCD600-1110-2-2-140HA03-HP358	30801230
11,20*	12	102	55	40	45	SCD600-1120-2-2-140HA03-HP358	30801231
11,25	12	102	55	40	45	SCD600-1125-2-2-140HA03-HP358	30801232
11,30	12	102	55	40	45	SCD600-1130-2-2-140HA03-HP358	30801233
11,35	12	102	55	40	45	SCD600-1135-2-2-140HA03-HP358	30801234

MEGA-Drill-Steel-Plus | Solid carbide twist drill SCD600 (3xD), external coolant supply

Dimensions						Shank form HA	
d ₁ m7	d ₂ h6	l ₁	l ₂	l ₃	l ₄	Specification	Order no.
11,40	12	102	55	40	45	SCD600-1140-2-2-140HA03-HP358	30801235
11,50	12	102	55	40	45	SCD600-1150-2-2-140HA03-HP358	30801237
11,60	12	102	55	40	45	SCD600-1160-2-2-140HA03-HP358	30801238
11,70	12	102	55	40	45	SCD600-1170-2-2-140HA03-HP358	30801239
11,80	12	102	55	40	45	SCD600-1180-2-2-140HA03-HP358	30801240
11,90	12	102	55	40	45	SCD600-1190-2-2-140HA03-HP358	30801241
12,00	12	102	55	40	45	SCD600-1200-2-2-140HA03-HP358	30801242
12,15	14	107	60	43	45	SCD600-1215-2-2-140HA03-HP358	30801243
12,25	14	107	60	43	45	SCD600-1225-2-2-140HA03-HP358	30801244
12,50	14	107	60	43	45	SCD600-1250-2-2-140HA03-HP358	30801245
12,55	14	107	60	43	45	SCD600-1255-2-2-140HA03-HP358	30801246
12,70	14	107	60	43	45	SCD600-1270-2-2-140HA03-HP358	30801247
12,80	14	107	60	43	45	SCD600-1280-2-2-140HA03-HP358	30801248
13,00	14	107	60	43	45	SCD600-1300-2-2-140HA03-HP358	30801250
13,10	14	107	60	43	45	SCD600-1310-2-2-140HA03-HP358	30801251
13,30	14	107	60	43	45	SCD600-1330-2-2-140HA03-HP358	30801252
13,35	14	107	60	43	45	SCD600-1335-2-2-140HA03-HP358	30801253
13,50	14	107	60	43	45	SCD600-1350-2-2-140HA03-HP358	30801254
13,70	14	107	60	43	45	SCD600-1370-2-2-140HA03-HP358	30801255
13,80	14	107	60	43	45	SCD600-1380-2-2-140HA03-HP358	30801256
14,00	14	107	60	43	45	SCD600-1400-2-2-140HA03-HP358	30801257
14,20	16	115	65	45	48	SCD600-1420-2-2-140HA03-HP358	30801258
14,50	16	115	65	45	48	SCD600-1450-2-2-140HA03-HP358	30801259
14,80	16	115	65	45	48	SCD600-1480-2-2-140HA03-HP358	30801260
15,00	16	115	65	45	48	SCD600-1500-2-2-140HA03-HP358	30801261
15,10	16	115	65	45	48	SCD600-1510-2-2-140HA03-HP358	30801262
15,25	16	115	65	45	48	SCD600-1525-2-2-140HA03-HP358	30801263
15,30	16	115	65	45	48	SCD600-1530-2-2-140HA03-HP358	30801264
15,35	16	115	65	45	48	SCD600-1535-2-2-140HA03-HP358	30801265
15,50	16	115	65	45	48	SCD600-1550-2-2-140HA03-HP358	30801266
15,60	16	115	65	45	48	SCD600-1560-2-2-140HA03-HP358	30801267
15,80	16	115	65	45	48	SCD600-1580-2-2-140HA03-HP358	30801268
16,00	16	115	65	45	48	SCD600-1600-2-2-140HA03-HP358	30801269
16,05	18	123	73	51	48	SCD600-1605-2-2-140HA03-HP358	30801270
16,50	18	123	73	51	48	SCD600-1650-2-2-140HA03-HP358	30801271
16,80	18	123	73	51	48	SCD600-1680-2-2-140HA03-HP358	30801272
17,00	18	123	73	51	48	SCD600-1700-2-2-140HA03-HP358	30801274
17,50	18	123	73	51	48	SCD600-1750-2-2-140HA03-HP358	30801275
17,80	18	123	73	51	48	SCD600-1780-2-2-140HA03-HP358	30801277
18,00	18	123	73	51	48	SCD600-1800-2-2-140HA03-HP358	30801278
18,50	20	131	79	55	50	SCD600-1850-2-2-140HA03-HP358	30801279
19,00	20	131	79	55	50	SCD600-1900-2-2-140HA03-HP358	30801282
19,35	20	131	79	55	50	SCD600-1935-2-2-140HA03-HP358	30801283
19,60	20	131	79	55	50	SCD600-1960-2-2-140HA03-HP358	30801285
19,80	20	131	79	55	50	SCD600-1980-2-2-140HA03-HP358	30801286
20,00	20	131	79	55	50	SCD600-2000-2-2-140HA03-HP358	30801287

Continued on next page.

MEGA-Drill-Steel-Plus | Solid carbide twist drill SCD600 (3xD), external coolant supply

Configurable features



Diameter:
Diameter in increments of 0.01 mm freely selectable





Shank form:
Shank form: HB | HE

Specification:
SCD600-[diameter]-3-3-140[shank form]03-HP358

Dimensions of configurable series

d ₁ min.	d ₁ max.	d ₂ h6	l ₁	l ₂	l ₃	l ₄
3,00	3,70	6	62	20	14	36
3,71	4,70	6	66	24	17	36
4,71	6,00	6	66	28	20	36
6,01	7,00	8	79	34	24	36
7,01	8,00	8	79	41	29	36
8,01	10,00	10	89	47	35	40
10,01	12,00	12	102	55	40	45
12,01	14,00	14	107	60	43	45
14,01	16,00	16	115	65	45	48
16,01	18,00	18	123	73	51	48
18,01	20,00	20	131	79	55	50

Example:

SCD600-0431-3-3-140HE03-HP358

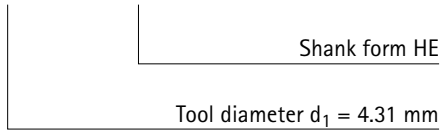

Dimensions in mm.

* Particularly suitable for the premanufacturing of core bores for thread formers.

For cutting data recommendations, see end of chapter.

Special designs and other coatings available upon request.

MEGA-Drill-Steel-Plus

Solid carbide twist drill

SCD601 (3xD), internal coolant supply, follow-up product to the MEGA-Drill-Steel (SCD10)

Design:

- Drill diameter: 3.00 – 25.00 mm
- Bore tolerance: \geq IT 9
- Cutting material: HP358
- Number of cutting edges: 2
- Number of guiding chamfers: 2
- Tip angle: 140°
- Helix angle: 30°

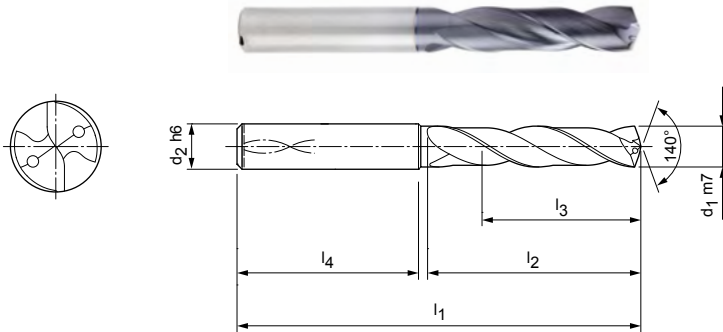

Stocked preferred series in shank form HA

Dimensions						Shank form HA	
d ₁ m7	d ₂ h6	l ₁	l ₂	l ₃	l ₄	Specification	Order no.
3,00	6	62	20	14	36	SCD601-0300-2-2-140HA03-HP358	30802107
3,10	6	62	20	14	36	SCD601-0310-2-2-140HA03-HP358	30802108
3,15	6	62	20	14	36	SCD601-0315-2-2-140HA03-HP358	30802109
3,20	6	62	20	14	36	SCD601-0320-2-2-140HA03-HP358	30802110
3,22	6	62	20	14	36	SCD601-0322-2-2-140HA03-HP358	30802111
3,25	6	62	20	14	36	SCD601-0325-2-2-140HA03-HP358	30802112
3,30	6	62	20	14	36	SCD601-0330-2-2-140HA03-HP358	30802113
3,40	6	62	20	14	36	SCD601-0340-2-2-140HA03-HP358	30802115
3,50	6	62	20	14	36	SCD601-0350-2-2-140HA03-HP358	30802116
3,60	6	62	20	14	36	SCD601-0360-2-2-140HA03-HP358	30802117
3,70*	6	62	20	14	36	SCD601-0370-2-2-140HA03-HP358	30802118
3,80	6	66	24	17	36	SCD601-0380-2-2-140HA03-HP358	30802119
3,85	6	66	24	17	36	SCD601-0385-2-2-140HA03-HP358	30802120
3,90	6	66	24	17	36	SCD601-0390-2-2-140HA03-HP358	30802121
4,00	6	66	24	17	36	SCD601-0400-2-2-140HA03-HP358	30802122
4,10	6	66	24	17	36	SCD601-0410-2-2-140HA03-HP358	30802123
4,20	6	66	24	17	36	SCD601-0420-2-2-140HA03-HP358	30802124
4,25	6	66	24	17	36	SCD601-0425-2-2-140HA03-HP358	30802125
4,30	6	66	24	17	36	SCD601-0430-2-2-140HA03-HP358	30802126
4,40	6	66	24	17	36	SCD601-0440-2-2-140HA03-HP358	30802129
4,50	6	66	24	17	36	SCD601-0450-2-2-140HA03-HP358	30802131
4,60	6	66	24	17	36	SCD601-0460-2-2-140HA03-HP358	30802132
4,65*	6	66	24	17	36	SCD601-0465-2-2-140HA03-HP358	30802133
4,70	6	66	24	17	36	SCD601-0470-2-2-140HA03-HP358	30802134
4,80	6	66	28	20	36	SCD601-0480-2-2-140HA03-HP358	30802135
4,90	6	66	28	20	36	SCD601-0490-2-2-140HA03-HP358	30802136
4,95	6	66	28	20	36	SCD601-0495-2-2-140HA03-HP358	30802137
5,00	6	66	28	20	36	SCD601-0500-2-2-140HA03-HP358	30802138
5,05	6	66	28	20	36	SCD601-0505-2-2-140HA03-HP358	30802139
5,10	6	66	28	20	36	SCD601-0510-2-2-140HA03-HP358	30802140
5,20	6	66	28	20	36	SCD601-0520-2-2-140HA03-HP358	30802141
5,30	6	66	28	20	36	SCD601-0530-2-2-140HA03-HP358	30802142
5,40	6	66	28	20	36	SCD601-0540-2-2-140HA03-HP358	30802143
5,50	6	66	28	20	36	SCD601-0550-2-2-140HA03-HP358	30802144
5,55*	6	66	28	20	36	SCD601-0555-2-2-140HA03-HP358	30802145

MEGA-Drill-Steel-Plus | Solid carbide twist drill SCD601 (3xD), internal coolant supply

Dimensions						Shank form HA	
d ₁ m7	d ₂ h6	l ₁	l ₂	l ₃	l ₄	Specification	Order no.
5,60	6	66	28	20	36	SCD601-0560-2-2-140HA03-HP358	30802146
5,70	6	66	28	20	36	SCD601-0570-2-2-140HA03-HP358	30802147
5,75	6	66	28	20	36	SCD601-0575-2-2-140HA03-HP358	30802148
5,80	6	66	28	20	36	SCD601-0580-2-2-140HA03-HP358	30802149
5,90	6	66	28	20	36	SCD601-0590-2-2-140HA03-HP358	30802150
5,95	6	66	28	20	36	SCD601-0595-2-2-140HA03-HP358	30802151
6,00	6	66	28	20	36	SCD601-0600-2-2-140HA03-HP358	30802152
6,10	8	79	34	24	36	SCD601-0610-2-2-140HA03-HP358	30802153
6,20	8	79	34	24	36	SCD601-0620-2-2-140HA03-HP358	30802154
6,30	8	79	34	24	36	SCD601-0630-2-2-140HA03-HP358	30802155
6,40	8	79	34	24	36	SCD601-0640-2-2-140HA03-HP358	30802156
6,50	8	79	34	24	36	SCD601-0650-2-2-140HA03-HP358	30802157
6,60	8	79	34	24	36	SCD601-0660-2-2-140HA03-HP358	30802158
6,70	8	79	34	24	36	SCD601-0670-2-2-140HA03-HP358	30802159
6,80	8	79	34	24	36	SCD601-0680-2-2-140HA03-HP358	30802160
6,90	8	79	34	24	36	SCD601-0690-2-2-140HA03-HP358	30802161
7,00	8	79	34	24	36	SCD601-0700-2-2-140HA03-HP358	30802162
7,10	8	79	41	29	36	SCD601-0710-2-2-140HA03-HP358	30802163
7,20	8	79	41	29	36	SCD601-0720-2-2-140HA03-HP358	30802164
7,30	8	79	41	29	36	SCD601-0730-2-2-140HA03-HP358	30802165
7,40	8	79	41	29	36	SCD601-0740-2-2-140HA03-HP358	30802166
7,45*	8	79	41	29	36	SCD601-0745-2-2-140HA03-HP358	30802167
7,50	8	79	41	29	36	SCD601-0750-2-2-140HA03-HP358	30802168
7,60	8	79	41	29	36	SCD601-0760-2-2-140HA03-HP358	30802169
7,70	8	79	41	29	36	SCD601-0770-2-2-140HA03-HP358	30802170
7,80	8	79	41	29	36	SCD601-0780-2-2-140HA03-HP358	30802171
7,90	8	79	41	29	36	SCD601-0790-2-2-140HA03-HP358	30802172
8,00	8	79	41	29	36	SCD601-0800-2-2-140HA03-HP358	30802173
8,10	10	89	47	35	40	SCD601-0810-2-2-140HA03-HP358	30802174
8,20	10	89	47	35	40	SCD601-0820-2-2-140HA03-HP358	30802175
8,30	10	89	47	35	40	SCD601-0830-2-2-140HA03-HP358	30802176
8,40	10	89	47	35	40	SCD601-0840-2-2-140HA03-HP358	30802177
8,50	10	89	47	35	40	SCD601-0850-2-2-140HA03-HP358	30802178
8,60	10	89	47	35	40	SCD601-0860-2-2-140HA03-HP358	30802179
8,70	10	89	47	35	40	SCD601-0870-2-2-140HA03-HP358	30802180
8,80	10	89	47	35	40	SCD601-0880-2-2-140HA03-HP358	30802181
8,90	10	89	47	35	40	SCD601-0890-2-2-140HA03-HP358	30802182
9,00	10	89	47	35	40	SCD601-0900-2-2-140HA03-HP358	30802183
9,10	10	89	47	35	40	SCD601-0910-2-2-140HA03-HP358	30802184
9,20	10	89	47	35	40	SCD601-0920-2-2-140HA03-HP358	30802185
9,30*	10	89	47	35	40	SCD601-0930-2-2-140HA03-HP358	30802186
9,35	10	89	47	35	40	SCD601-0935-2-2-140HA03-HP358	30802187
9,40	10	89	47	35	40	SCD601-0940-2-2-140HA03-HP358	30802188
9,50	10	89	47	35	40	SCD601-0950-2-2-140HA03-HP358	30802190
9,60	10	89	47	35	40	SCD601-0960-2-2-140HA03-HP358	30802191
9,70	10	89	47	35	40	SCD601-0970-2-2-140HA03-HP358	30802192
9,80	10	89	47	35	40	SCD601-0980-2-2-140HA03-HP358	30802193
9,90	10	89	47	35	40	SCD601-0990-2-2-140HA03-HP358	30802194
10,00	10	89	47	35	40	SCD601-1000-2-2-140HA03-HP358	30802195
10,10	12	102	55	40	45	SCD601-1010-2-2-140HA03-HP358	30802196
10,20	12	102	55	40	45	SCD601-1020-2-2-140HA03-HP358	30802197
10,30	12	102	55	40	45	SCD601-1030-2-2-140HA03-HP358	30802198
10,40	12	102	55	40	45	SCD601-1040-2-2-140HA03-HP358	30802199
10,50	12	102	55	40	45	SCD601-1050-2-2-140HA03-HP358	30802200
10,55	12	102	55	40	45	SCD601-1055-2-2-140HA03-HP358	30802201
10,60	12	102	55	40	45	SCD601-1060-2-2-140HA03-HP358	30802202
10,70	12	102	55	40	45	SCD601-1070-2-2-140HA03-HP358	30802203

MEGA-Drill-Steel-Plus | Solid carbide twist drill SCD601 (3xD), internal coolant supply

Dimensions						Shank form HA	
d ₁ m7	d ₂ h6	l ₁	l ₂	l ₃	l ₄	Specification	Order no.
10,75	12	102	55	40	45	SCD601-1075-2-2-140HA03-HP358	30802204
10,80	12	102	55	40	45	SCD601-1080-2-2-140HA03-HP358	30802205
10,90	12	102	55	40	45	SCD601-1090-2-2-140HA03-HP358	30802206
11,00	12	102	55	40	45	SCD601-1100-2-2-140HA03-HP358	30802207
11,10	12	102	55	40	45	SCD601-1110-2-2-140HA03-HP358	30802208
11,20*	12	102	55	40	45	SCD601-1120-2-2-140HA03-HP358	30802209
11,25	12	102	55	40	45	SCD601-1125-2-2-140HA03-HP358	30802210
11,30	12	102	55	40	45	SCD601-1130-2-2-140HA03-HP358	30802211
11,45	12	102	55	40	45	SCD601-1145-2-2-140HA03-HP358	30802214
11,50	12	102	55	40	45	SCD601-1150-2-2-140HA03-HP358	30802215
11,60	12	102	55	40	45	SCD601-1160-2-2-140HA03-HP358	30802216
11,70	12	102	55	40	45	SCD601-1170-2-2-140HA03-HP358	30802217
11,80	12	102	55	40	45	SCD601-1180-2-2-140HA03-HP358	30802218
11,90	12	102	55	40	45	SCD601-1190-2-2-140HA03-HP358	30802219
12,00	12	102	55	40	45	SCD601-1200-2-2-140HA03-HP358	30802220
12,15	14	107	60	43	45	SCD601-1215-2-2-140HA03-HP358	30802221
12,20	14	107	60	43	45	SCD601-1220-2-2-140HA03-HP358	31307544
12,25	14	107	60	43	45	SCD601-1225-2-2-140HA03-HP358	30802222
12,50	14	107	60	43	45	SCD601-1250-2-2-140HA03-HP358	30802223
12,55	14	107	60	43	45	SCD601-1255-2-2-140HA03-HP358	30802224
12,70	14	107	60	43	45	SCD601-1270-2-2-140HA03-HP358	30802225
12,80	14	107	60	43	45	SCD601-1280-2-2-140HA03-HP358	30802226
12,90	14	107	60	43	45	SCD601-1290-2-2-140HA03-HP358	30802227
13,00	14	107	60	43	45	SCD601-1300-2-2-140HA03-HP358	30802228
13,10	14	107	60	43	45	SCD601-1310-2-2-140HA03-HP358	30802229
13,30	14	107	60	43	45	SCD601-1330-2-2-140HA03-HP358	30802230
13,35	14	107	60	43	45	SCD601-1335-2-2-140HA03-HP358	30802231
13,50	14	107	60	43	45	SCD601-1350-2-2-140HA03-HP358	30802232
13,70	14	107	60	43	45	SCD601-1370-2-2-140HA03-HP358	30802233
13,80	14	107	60	43	45	SCD601-1380-2-2-140HA03-HP358	30802234
14,00	14	107	60	43	45	SCD601-1400-2-2-140HA03-HP358	30802235
14,20	16	115	65	45	48	SCD601-1420-2-2-140HA03-HP358	30802236
14,50	16	115	65	45	48	SCD601-1450-2-2-140HA03-HP358	30802237
14,80	16	115	65	45	48	SCD601-1480-2-2-140HA03-HP358	30802238
15,00	16	115	65	45	48	SCD601-1500-2-2-140HA03-HP358	30802239
15,10	16	115	65	45	48	SCD601-1510-2-2-140HA03-HP358	30802240
15,25	16	115	65	45	48	SCD601-1525-2-2-140HA03-HP358	30802241
15,30	16	115	65	45	48	SCD601-1530-2-2-140HA03-HP358	30802242
15,35	16	115	65	45	48	SCD601-1535-2-2-140HA03-HP358	30802243
15,50	16	115	65	45	48	SCD601-1550-2-2-140HA03-HP358	30802244
15,60	16	115	65	45	48	SCD601-1560-2-2-140HA03-HP358	30802245
15,80	16	115	65	45	48	SCD601-1580-2-2-140HA03-HP358	30802246
16,00	16	115	65	45	48	SCD601-1600-2-2-140HA03-HP358	30802247
16,05	18	123	73	51	48	SCD601-1605-2-2-140HA03-HP358	30802248
16,50	18	123	73	51	48	SCD601-1650-2-2-140HA03-HP358	30802249
16,60	18	123	73	51	48	SCD601-1660-2-2-140HA03-HP358	31307545
16,90	18	123	73	51	48	SCD601-1690-2-2-140HA03-HP358	30802251
17,00	18	123	73	51	48	SCD601-1700-2-2-140HA03-HP358	30802252
17,50	18	123	73	51	48	SCD601-1750-2-2-140HA03-HP358	30802253
17,60	18	123	73	51	48	SCD601-1760-2-2-140HA03-HP358	30802254
17,80	18	123	73	51	48	SCD601-1780-2-2-140HA03-HP358	30802255
18,00	18	123	73	51	48	SCD601-1800-2-2-140HA03-HP358	30802256
18,50	20	131	79	55	50	SCD601-1850-2-2-140HA03-HP358	30802257
18,90	20	131	79	55	50	SCD601-1890-2-2-140HA03-HP358	30802259
19,00	20	131	79	55	50	SCD601-1900-2-2-140HA03-HP358	30802260
19,35	20	131	79	55	50	SCD601-1935-2-2-140HA03-HP358	30802261
19,50	20	131	79	55	50	SCD601-1950-2-2-140HA03-HP358	30802262

Continued on next page.

MEGA-Drill-Steel-Plus | Solid carbide twist drill SCD601 (3xD), internal coolant supply

Dimensions						Shank form HA	
d ₁ m7	d ₂ h6	l ₁	l ₂	l ₃	l ₄	Specification	Order no.
19,80	20	131	79	55	50	SCD601-1980-2-2-140HA03-HP358	30802264
20,00	20	131	79	55	50	SCD601-2000-2-2-140HA03-HP358	30802265
21,00	25	151	93	66	56	SCD601-2100-2-2-140HA03-HP358	30802267
21,50	25	151	93	66	56	SCD601-2150-2-2-140HA03-HP358	30802268
22,00	25	151	93	66	56	SCD601-2200-2-2-140HA03-HP358	30802269
23,50	25	151	93	66	56	SCD601-2350-2-2-140HA03-HP358	30802272

Configurable features

**Diameter:**

Diameter in increments of 0.01 mm freely selectable

**Shank form:**

Shank form: HB | HE

Specification:

SCD601-[diameter]-3-3-140[shank form]03-HP358

Example:

SCD601-0431-3-3-140HE03-HP358

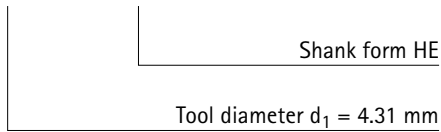

Dimensions of configurable series

d ₁ min.	d ₁ max.	d ₂ h6	l ₁	l ₂	l ₃	l ₄
3,00	3,70	6	62	20	14	36
3,71	4,70	6	66	24	17	36
4,71	6,00	6	66	28	20	36
6,01	7,00	8	79	34	24	36
7,01	8,00	8	79	41	29	36
8,01	10,00	10	89	47	35	40
10,01	12,00	12	102	55	40	45
12,01	14,00	14	107	60	43	45
14,01	16,00	16	115	65	45	48
16,01	18,00	18	123	73	51	48
18,01	20,00	20	131	79	55	50
20,01	25,00	25	151	93	66	56

Dimensions in mm.

* Particularly suitable for the premanufacturing of core bores for thread formers.

For cutting data recommendations, see end of chapter.

Special designs and other coatings available upon request.

MEGA-Drill-Steel-Plus

Solid carbide twist drill

SCD600 (5xD), external coolant supply, follow-up product to the MEGA-Drill-Steel (SCD10)

Design:

- Drill diameter: 3.00 – 25.00 mm
- Bore tolerance: ≥ IT 9
- Cutting material: HP358
- Number of cutting edges: 2
- Number of guiding chamfers: 2
- Tip angle: 140°
- Helix angle: 30°

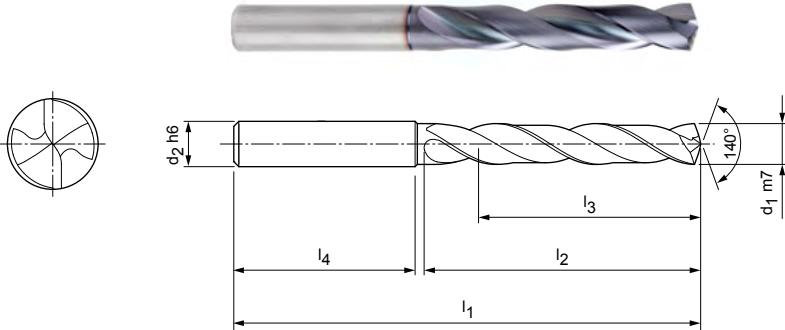

Stocked preferred series in shank form HA

Dimensions						Shank form HA	
d ₁ m7	d ₂ h6	l ₁	l ₂	l ₃	l ₄	Specification	Order no.
3,00	6	66	28	23	36	SCD600-0300-2-2-140HA05-HP358	30801634
3,10	6	66	28	23	36	SCD600-0310-2-2-140HA05-HP358	30801635
3,15	6	66	28	23	36	SCD600-0315-2-2-140HA05-HP358	30801636
3,20	6	66	28	23	36	SCD600-0320-2-2-140HA05-HP358	30801637
3,25	6	66	28	23	36	SCD600-0325-2-2-140HA05-HP358	30801639
3,30	6	66	28	23	36	SCD600-0330-2-2-140HA05-HP358	30801640
3,40	6	66	28	23	36	SCD600-0340-2-2-140HA05-HP358	30801641
3,50	6	66	28	23	36	SCD600-0350-2-2-140HA05-HP358	30801642
3,60	6	66	28	23	36	SCD600-0360-2-2-140HA05-HP358	30801643
3,70	6	66	28	23	36	SCD600-0370-2-2-140HA05-HP358	30801644
3,80	6	74	36	29	36	SCD600-0380-2-2-140HA05-HP358	30801645
3,90	6	74	36	29	36	SCD600-0390-2-2-140HA05-HP358	30801647
4,00	6	74	36	29	36	SCD600-0400-2-2-140HA05-HP358	30801648
4,10	6	74	36	29	36	SCD600-0410-2-2-140HA05-HP358	30801649
4,20	6	74	36	29	36	SCD600-0420-2-2-140HA05-HP358	30801650
4,25	6	74	36	29	36	SCD600-0425-2-2-140HA05-HP358	30801651
4,30	6	74	36	29	36	SCD600-0430-2-2-140HA05-HP358	30801652
4,35	6	74	36	29	36	SCD600-0435-2-2-140HA05-HP358	30801653
4,40	6	74	36	29	36	SCD600-0440-2-2-140HA05-HP358	30801654
4,50	6	74	36	29	36	SCD600-0450-2-2-140HA05-HP358	30801656
4,60	6	74	36	29	36	SCD600-0460-2-2-140HA05-HP358	30801657
4,65	6	74	36	29	36	SCD600-0465-2-2-140HA05-HP358	30801658
4,70	6	74	36	29	36	SCD600-0470-2-2-140HA05-HP358	30801659
4,80	6	82	44	35	36	SCD600-0480-2-2-140HA05-HP358	30801660
4,90	6	82	44	35	36	SCD600-0490-2-2-140HA05-HP358	30801662
4,95	6	82	44	35	36	SCD600-0495-2-2-140HA05-HP358	30801663
5,00	6	82	44	35	36	SCD600-0500-2-2-140HA05-HP358	30801664
5,05	6	82	44	35	36	SCD600-0505-2-2-140HA05-HP358	30801665
5,10	6	82	44	35	36	SCD600-0510-2-2-140HA05-HP358	30801666
5,20	6	82	44	35	36	SCD600-0520-2-2-140HA05-HP358	30801667
5,30	6	82	44	35	36	SCD600-0530-2-2-140HA05-HP358	30801668
5,40	6	82	44	35	36	SCD600-0540-2-2-140HA05-HP358	30801669
5,50	6	82	44	35	36	SCD600-0550-2-2-140HA05-HP358	30801670
5,55	6	82	44	35	36	SCD600-0555-2-2-140HA05-HP358	30801671
5,60	6	82	44	35	36	SCD600-0560-2-2-140HA05-HP358	30801672

MEGA-Drill-Steel-Plus | Solid carbide twist drill SCD600 (5xD), external coolant supply

Dimensions						Shank form HA	
d ₁ m7	d ₂ h6	l ₁	l ₂	l ₃	l ₄	Specification	Order no.
5,70	6	82	44	35	36	SCD600-0570-2-2-140HA05-HP358	30801673
5,75	6	82	44	35	36	SCD600-0575-2-2-140HA05-HP358	30801674
5,80	6	82	44	35	36	SCD600-0580-2-2-140HA05-HP358	30801675
5,90	6	82	44	35	36	SCD600-0590-2-2-140HA05-HP358	30801676
5,95	6	82	44	35	36	SCD600-0595-2-2-140HA05-HP358	30801677
6,00	6	82	44	35	36	SCD600-0600-2-2-140HA05-HP358	30801678
6,10	8	91	53	43	36	SCD600-0610-2-2-140HA05-HP358	30801679
6,20	8	91	53	43	36	SCD600-0620-2-2-140HA05-HP358	30801680
6,30	8	91	53	43	36	SCD600-0630-2-2-140HA05-HP358	30801681
6,40	8	91	53	43	36	SCD600-0640-2-2-140HA05-HP358	30801682
6,50	8	91	53	43	36	SCD600-0650-2-2-140HA05-HP358	30801683
6,60	8	91	53	43	36	SCD600-0660-2-2-140HA05-HP358	30801684
6,70	8	91	53	43	36	SCD600-0670-2-2-140HA05-HP358	30801685
6,80	8	91	53	43	36	SCD600-0680-2-2-140HA05-HP358	30801686
6,90	8	91	53	43	36	SCD600-0690-2-2-140HA05-HP358	30801687
7,00	8	91	53	43	36	SCD600-0700-2-2-140HA05-HP358	30801688
7,10	8	91	53	43	36	SCD600-0710-2-2-140HA05-HP358	30801689
7,20	8	91	53	43	36	SCD600-0720-2-2-140HA05-HP358	30801690
7,30	8	91	53	43	36	SCD600-0730-2-2-140HA05-HP358	30801691
7,40	8	91	53	43	36	SCD600-0740-2-2-140HA05-HP358	30801692
7,45	8	91	53	43	36	SCD600-0745-2-2-140HA05-HP358	30801693
7,50	8	91	53	43	36	SCD600-0750-2-2-140HA05-HP358	30801694
7,60	8	91	53	43	36	SCD600-0760-2-2-140HA05-HP358	30801695
7,80	8	91	53	43	36	SCD600-0780-2-2-140HA05-HP358	30801697
7,90	8	91	53	43	36	SCD600-0790-2-2-140HA05-HP358	30801698
8,00	8	91	53	43	36	SCD600-0800-2-2-140HA05-HP358	30801699
8,10	10	103	61	49	40	SCD600-0810-2-2-140HA05-HP358	30801700
8,20	10	103	61	49	40	SCD600-0820-2-2-140HA05-HP358	30801701
8,30	10	103	61	49	40	SCD600-0830-2-2-140HA05-HP358	30801702
8,40	10	103	61	49	40	SCD600-0840-2-2-140HA05-HP358	30801703
8,50	10	103	61	49	40	SCD600-0850-2-2-140HA05-HP358	30801704
8,60	10	103	61	49	40	SCD600-0860-2-2-140HA05-HP358	30801705
8,70	10	103	61	49	40	SCD600-0870-2-2-140HA05-HP358	30801706
8,80	10	103	61	49	40	SCD600-0880-2-2-140HA05-HP358	30801707
8,90	10	103	61	49	40	SCD600-0890-2-2-140HA05-HP358	30801708
9,00	10	103	61	49	40	SCD600-0900-2-2-140HA05-HP358	30801709
9,10	10	103	61	49	40	SCD600-0910-2-2-140HA05-HP358	30801710
9,20	10	103	61	49	40	SCD600-0920-2-2-140HA05-HP358	30801711
9,30	10	103	61	49	40	SCD600-0930-2-2-140HA05-HP358	30801712
9,50	10	103	61	49	40	SCD600-0950-2-2-140HA05-HP358	30801716
9,60	10	103	61	49	40	SCD600-0960-2-2-140HA05-HP358	30801717
9,70	10	103	61	49	40	SCD600-0970-2-2-140HA05-HP358	30801718
9,80	10	103	61	49	40	SCD600-0980-2-2-140HA05-HP358	30801719
9,90	10	103	61	49	40	SCD600-0990-2-2-140HA05-HP358	30801720
10,00	10	103	61	49	40	SCD600-1000-2-2-140HA05-HP358	30801721
10,10	12	118	71	56	45	SCD600-1010-2-2-140HA05-HP358	30801722
10,20	12	118	71	56	45	SCD600-1020-2-2-140HA05-HP358	30801723
10,30	12	118	71	56	45	SCD600-1030-2-2-140HA05-HP358	30801724
10,40	12	118	71	56	45	SCD600-1040-2-2-140HA05-HP358	30801725
10,50	12	118	71	56	45	SCD600-1050-2-2-140HA05-HP358	30801726
10,70	12	118	71	56	45	SCD600-1070-2-2-140HA05-HP358	30801729
10,75	12	118	71	56	45	SCD600-1075-2-2-140HA05-HP358	30801731
10,80	12	118	71	56	45	SCD600-1080-2-2-140HA05-HP358	30801732
11,00	12	118	71	56	45	SCD600-1100-2-2-140HA05-HP358	30801734
11,20	12	118	71	56	45	SCD600-1120-2-2-140HA05-HP358	30801736
11,25	12	118	71	56	45	SCD600-1125-2-2-140HA05-HP358	30801737
11,30	12	118	71	56	45	SCD600-1130-2-2-140HA05-HP358	30801738

MEGA-Drill-Steel-Plus | Solid carbide twist drill SCD600 (5xD), external coolant supply

Dimensions						Shank form HA	
d ₁ m7	d ₂ h6	l ₁	l ₂	l ₃	l ₄	Specification	Order no.
11,35	12	118	71	56	45	SCD600-1135-2-2-140HA05-HP358	30801739
11,50	12	118	71	56	45	SCD600-1150-2-2-140HA05-HP358	30801742
11,80	12	118	71	56	45	SCD600-1180-2-2-140HA05-HP358	30801745
11,90	12	118	71	56	45	SCD600-1190-2-2-140HA05-HP358	30801746
12,00	12	118	71	56	45	SCD600-1200-2-2-140HA05-HP358	30801747
12,15	14	124	77	60	45	SCD600-1215-2-2-140HA05-HP358	30801748
12,25	14	124	77	60	45	SCD600-1225-2-2-140HA05-HP358	30801749
12,50	14	124	77	60	45	SCD600-1250-2-2-140HA05-HP358	30801750
12,70	14	124	77	60	45	SCD600-1270-2-2-140HA05-HP358	30801752
12,80	14	124	77	60	45	SCD600-1280-2-2-140HA05-HP358	30801753
12,90	14	124	77	60	45	SCD600-1290-2-2-140HA05-HP358	30801754
13,00	14	124	77	60	45	SCD600-1300-2-2-140HA05-HP358	30801755
13,10	14	124	77	60	45	SCD600-1310-2-2-140HA05-HP358	30801756
13,30	14	124	77	60	45	SCD600-1330-2-2-140HA05-HP358	30801757
13,35	14	124	77	60	45	SCD600-1335-2-2-140HA05-HP358	30801758
13,50	14	124	77	60	45	SCD600-1350-2-2-140HA05-HP358	30801759
13,80	14	124	77	60	45	SCD600-1380-2-2-140HA05-HP358	30801761
14,00	14	124	77	60	45	SCD600-1400-2-2-140HA05-HP358	30801762
14,20	16	133	83	63	48	SCD600-1420-2-2-140HA05-HP358	30801763
14,50	16	133	83	63	48	SCD600-1450-2-2-140HA05-HP358	30801764
14,80	16	133	83	63	48	SCD600-1480-2-2-140HA05-HP358	30801765
15,00	16	133	83	63	48	SCD600-1500-2-2-140HA05-HP358	30801766
15,10	16	133	83	63	48	SCD600-1510-2-2-140HA05-HP358	30801767
15,25	16	133	83	63	48	SCD600-1525-2-2-140HA05-HP358	30801768
15,30	16	133	83	63	48	SCD600-1530-2-2-140HA05-HP358	30801769
15,50	16	133	83	63	48	SCD600-1550-2-2-140HA05-HP358	30801771
15,80	16	133	83	63	48	SCD600-1580-2-2-140HA05-HP358	30801773
16,00	16	133	83	63	48	SCD600-1600-2-2-140HA05-HP358	30801774
16,50	18	143	93	71	48	SCD600-1650-2-2-140HA05-HP358	30801776
16,80	18	143	93	71	48	SCD600-1680-2-2-140HA05-HP358	30801777
17,00	18	143	93	71	48	SCD600-1700-2-2-140HA05-HP358	30801779
17,50	18	143	93	71	48	SCD600-1750-2-2-140HA05-HP358	30801780
17,60	18	143	93	71	48	SCD600-1760-2-2-140HA05-HP358	30801781
18,00	18	143	93	71	48	SCD600-1800-2-2-140HA05-HP358	30801783
18,50	20	153	101	77	50	SCD600-1850-2-2-140HA05-HP358	30801784
18,80	20	153	101	77	50	SCD600-1880-2-2-140HA05-HP358	30801785
18,90	20	153	101	77	50	SCD600-1890-2-2-140HA05-HP358	30801786
19,00	20	153	101	77	50	SCD600-1900-2-2-140HA05-HP358	30801787
19,50	20	153	101	77	50	SCD600-1950-2-2-140HA05-HP358	30801789
19,80	20	153	101	77	50	SCD600-1980-2-2-140HA05-HP358	30801791
20,00	20	153	101	77	50	SCD600-2000-2-2-140HA05-HP358	30801792

Continued on next page.

MEGA-Drill-Steel-Plus | Solid carbide twist drill SCD600 (5xD), external coolant supply

Configurable features

**Diameter:**

Diameter in increments of 0.01 mm freely selectable

**Shank form:**

Shank form: HB | HE

Specification:

SCD600-[diameter]-3-3-140[shank form]05-HP358

Dimensions of configurable series

d ₁ min.	d ₁ max.	d ₂ h6	l ₁	l ₂	l ₃	l ₄
3,00	3,70	6	66	28	23	36
3,71	4,70	6	74	36	29	36
4,71	6,00	6	82	44	35	36
6,01	8,00	8	91	53	43	36
8,01	10,00	10	103	61	49	40
10,01	12,00	12	118	71	56	45
12,01	14,00	14	124	77	60	45
14,01	16,00	16	133	83	63	48
16,01	18,00	18	143	93	71	48
18,01	20,00	20	153	101	77	50

Example:

SCD600-0431-3-3-140HE05-HP358

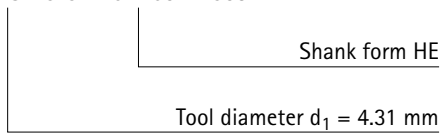

MEGA-Drill-Steel-Plus

Solid carbide twist drill

SCD601 (5xD), internal coolant supply, follow-up product to the MEGA-Drill-Steel (SCD10)

Design:

- Drill diameter: 3.00 – 25.00 mm
- Bore tolerance: \geq IT 9
- Cutting material: HP358
- Number of cutting edges: 2
- Number of guiding chamfers: 2
- Tip angle: 140°
- Helix angle: 30°

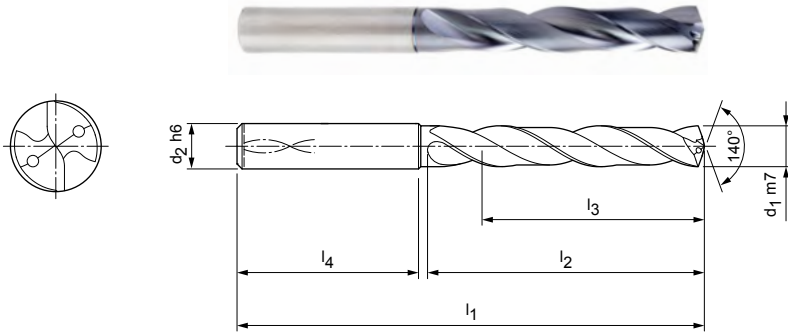

Stocked preferred series in shank form HA

Dimensions						Shank form HA	
d ₁ m7	d ₂ h6	l ₁	l ₂	l ₃	l ₄	Specification	Order no.
3,00	6	66	28	23	36	SCD601-0300-2-2-140HA05-HP358	30802611
3,10	6	66	28	23	36	SCD601-0310-2-2-140HA05-HP358	30802612
3,15	6	66	28	23	36	SCD601-0315-2-2-140HA05-HP358	30802613
3,20	6	66	28	23	36	SCD601-0320-2-2-140HA05-HP358	30802614
3,25	6	66	28	23	36	SCD601-0325-2-2-140HA05-HP358	30802616
3,30	6	66	28	23	36	SCD601-0330-2-2-140HA05-HP358	30802617
3,40	6	66	28	23	36	SCD601-0340-2-2-140HA05-HP358	30802618
3,50	6	66	28	23	36	SCD601-0350-2-2-140HA05-HP358	30802619
3,60	6	66	28	23	36	SCD601-0360-2-2-140HA05-HP358	30802620
3,65	6	66	28	23	36	SCD601-0365-2-2-140HA05-HP358	31307546
3,70*	6	66	28	23	36	SCD601-0370-2-2-140HA05-HP358	30802621
3,80	6	74	36	29	36	SCD601-0380-2-2-140HA05-HP358	30802622
3,85	6	74	36	29	36	SCD601-0385-2-2-140HA05-HP358	30802623
3,90	6	74	36	29	36	SCD601-0390-2-2-140HA05-HP358	30802624
4,00	6	74	36	29	36	SCD601-0400-2-2-140HA05-HP358	30802625
4,10	6	74	36	29	36	SCD601-0410-2-2-140HA05-HP358	30802626
4,20	6	74	36	29	36	SCD601-0420-2-2-140HA05-HP3583	30802627
4,25	6	74	36	29	36	SCD601-0425-2-2-140HA05-HP358	30802628
4,30	6	74	36	29	36	SCD601-0430-2-2-140HA05-HP358	30802629
4,35	6	74	36	29	36	SCD601-0435-2-2-140HA05-HP358	30802630
4,40	6	74	36	29	36	SCD601-0440-2-2-140HA05-HP358	30802631
4,45	6	74	36	29	36	SCD601-0445-2-2-140HA05-HP358	30802632
4,50	6	74	36	29	36	SCD601-0450-2-2-140HA05-HP358	30802633
4,60	6	74	36	29	36	SCD601-0460-2-2-140HA05-HP358	30802634
4,65*	6	74	36	29	36	SCD601-0465-2-2-140HA05-HP358	30802635
4,70	6	74	36	29	36	SCD601-0470-2-2-140HA05-HP358	30802636
4,80	6	82	44	35	36	SCD601-0480-2-2-140HA05-HP358	30802637
4,90	6	82	44	35	36	SCD601-0490-2-2-140HA05-HP358	30802638
4,95	6	82	44	35	36	SCD601-0495-2-2-140HA05-HP358	30802639
5,00	6	82	44	35	36	SCD601-0500-2-2-140HA05-HP358	30802640
5,05	6	82	44	35	36	SCD601-0505-2-2-140HA05-HP358	30802641
5,10	6	82	44	35	36	SCD601-0510-2-2-140HA05-HP358	30802642
5,20	6	82	44	35	36	SCD601-0520-2-2-140HA05-HP358	30802643
5,30	6	82	44	35	36	SCD601-0530-2-2-140HA05-HP358	30802644
5,40	6	82	44	35	36	SCD601-0540-2-2-140HA05-HP358	30802645

MEGA-Drill-Steel-Plus | Solid carbide twist drill SCD601 (5xD), internal coolant supply

Dimensions						Shank form HA	
d ₁ m7	d ₂ h6	l ₁	l ₂	l ₃	l ₄	Specification	Order no.
5,50	6	82	44	35	36	SCD601-0550-2-2-140HA05-HP358	30802646
5,55*	6	82	44	35	36	SCD601-0555-2-2-140HA05-HP358	30802647
5,60	6	82	44	35	36	SCD601-0560-2-2-140HA05-HP358	30802648
5,70	6	82	44	35	36	SCD601-0570-2-2-140HA05-HP358	30802649
5,75	6	82	44	35	36	SCD601-0575-2-2-140HA05-HP358	30802650
5,80	6	82	44	35	36	SCD601-0580-2-2-140HA05-HP358	30802651
5,90	6	82	44	35	36	SCD601-0590-2-2-140HA05-HP358	30802652
5,95	6	82	44	35	36	SCD601-0595-2-2-140HA05-HP358	30802653
6,00	6	82	44	35	36	SCD601-0600-2-2-140HA05-HP358	30802654
6,10	8	91	53	43	36	SCD601-0610-2-2-140HA05-HP358	30802655
6,20	8	91	53	43	36	SCD601-0620-2-2-140HA05-HP358	30802656
6,30	8	91	53	43	36	SCD601-0630-2-2-140HA05-HP358	30802657
6,40	8	91	53	43	36	SCD601-0640-2-2-140HA05-HP358	30802658
6,50	8	91	53	43	36	SCD601-0650-2-2-140HA05-HP358	30802659
6,60	8	91	53	43	36	SCD601-0660-2-2-140HA05-HP358	30802660
6,70	8	91	53	43	36	SCD601-0670-2-2-140HA05-HP358	30802661
6,80	8	91	53	43	36	SCD601-0680-2-2-140HA05-HP358	30802662
6,90	8	91	53	43	36	SCD601-0690-2-2-140HA05-HP358	30802663
7,00	8	91	53	43	36	SCD601-0700-2-2-140HA05-HP358	30802664
7,10	8	91	53	43	36	SCD601-0710-2-2-140HA05-HP358	30802665
7,20	8	91	53	43	36	SCD601-0720-2-2-140HA05-HP358	30802666
7,30	8	91	53	43	36	SCD601-0730-2-2-140HA05-HP358	30802667
7,40	8	91	53	43	36	SCD601-0740-2-2-140HA05-HP358	30802668
7,45*	8	91	53	43	36	SCD601-0745-2-2-140HA05-HP358	30802669
7,50	8	91	53	43	36	SCD601-0750-2-2-140HA05-HP358	30802670
7,60	8	91	53	43	36	SCD601-0760-2-2-140HA05-HP358	30802671
7,70	8	91	53	43	36	SCD601-0770-2-2-140HA05-HP358	30802672
7,80	8	91	53	43	36	SCD601-0780-2-2-140HA05-HP358	30802673
7,90	8	91	53	43	36	SCD601-0790-2-2-140HA05-HP358	30802674
8,00	8	91	53	43	36	SCD601-0800-2-2-140HA05-HP358	30802675
8,10	10	103	61	49	40	SCD601-0810-2-2-140HA05-HP358	30802676
8,20	10	103	61	49	40	SCD601-0820-2-2-140HA05-HP358	30802677
8,30	10	103	61	49	40	SCD601-0830-2-2-140HA05-HP358	30802678
8,40	10	103	61	49	40	SCD601-0840-2-2-140HA05-HP358	30802679
8,50	10	103	61	49	40	SCD601-0850-2-2-140HA05-HP358	30802680
8,60	10	103	61	49	40	SCD601-0860-2-2-140HA05-HP358	30802681
8,70	10	103	61	49	40	SCD601-0870-2-2-140HA05-HP358	30802682
8,80	10	103	61	49	40	SCD601-0880-2-2-140HA05-HP358	30802683
8,90	10	103	61	49	40	SCD601-0890-2-2-140HA05-HP358	30802684
9,00	10	103	61	49	40	SCD601-0900-2-2-140HA05-HP358	30802685
9,10	10	103	61	49	40	SCD601-0910-2-2-140HA05-HP358	30802686
9,20	10	103	61	49	40	SCD601-0920-2-2-140HA05-HP358	30802687
9,30*	10	103	61	49	40	SCD601-0930-2-2-140HA05-HP358	30802688
9,35	10	103	61	49	40	SCD601-0935-2-2-140HA05-HP358	30802689
9,40	10	103	61	49	40	SCD601-0940-2-2-140HA05-HP358	30802690
9,45	10	103	61	49	40	SCD601-0945-2-2-140HA05-HP358	30802691
9,50	10	103	61	49	40	SCD601-0950-2-2-140HA05-HP358	30802692
9,60	10	103	61	49	40	SCD601-0960-2-2-140HA05-HP358	30802693
9,70	10	103	61	49	40	SCD601-0970-2-2-140HA05-HP358	30802694
9,80	10	103	61	49	40	SCD601-0980-2-2-140HA05-HP358	30802695
9,90	10	103	61	49	40	SCD601-0990-2-2-140HA05-HP358	30802696
10,00	10	103	61	49	40	SCD601-1000-2-2-140HA05-HP358	30802697
10,10	12	118	71	56	45	SCD601-1010-2-2-140HA05-HP358	30802698
10,20	12	118	71	56	45	SCD601-1020-2-2-140HA05-HP358	30802699
10,30	12	118	71	56	45	SCD601-1030-2-2-140HA05-HP358	30802700
10,40	12	118	71	56	45	SCD601-1040-2-2-140HA05-HP358	30802701
10,50	12	118	71	56	45	SCD601-1050-2-2-140HA05-HP358	30802702

MEGA-Drill-Steel-Plus | Solid carbide twist drill SCD601 (5xD), internal coolant supply

Dimensions						Shank form HA	
d ₁ m7	d ₂ h6	l ₁	l ₂	l ₃	l ₄	Specification	Order no.
10,55	12	118	71	56	45	SCD601-1055-2-2-140HA05-HP358	30802703
10,60	12	118	71	56	45	SCD601-1060-2-2-140HA05-HP358	30802704
10,70	12	118	71	56	45	SCD601-1070-2-2-140HA05-HP358	30802705
10,80	12	118	71	56	45	SCD601-1080-2-2-140HA05-HP358	30802707
10,90	12	118	71	56	45	SCD601-1090-2-2-140HA05-HP358	30802708
11,00	12	118	71	56	45	SCD601-1100-2-2-140HA05-HP358	30802709
11,10	12	118	71	56	45	SCD601-1110-2-2-140HA05-HP358	30802710
11,20*	12	118	71	56	45	SCD601-1120-2-2-140HA05-HP358	30802711
11,25	12	118	71	56	45	SCD601-1125-2-2-140HA05-HP358	30802712
11,30	12	118	71	56	45	SCD601-1130-2-2-140HA05-HP358	30802713
11,40	12	118	71	56	45	SCD601-1140-2-2-140HA05-HP358	30802715
11,50	12	118	71	56	45	SCD601-1150-2-2-140HA05-HP358	30802717
11,60	12	118	71	56	45	SCD601-1160-2-2-140HA05-HP358	30802718
11,70	12	118	71	56	45	SCD601-1170-2-2-140HA05-HP358	30802719
11,80	12	118	71	56	45	SCD601-1180-2-2-140HA05-HP358	30802720
11,90	12	118	71	56	45	SCD601-1190-2-2-140HA05-HP358	30802721
12,00	12	118	71	56	45	SCD601-1200-2-2-140HA05-HP358	30802722
12,15	14	124	77	60	45	SCD601-1215-2-2-140HA05-HP358	30802723
12,25	14	124	77	60	45	SCD601-1225-2-2-140HA05-HP358	30802724
12,30	14	124	77	60	45	SCD601-1230-2-2-140HA05-HP358	31201193
12,50	14	124	77	60	45	SCD601-1250-2-2-140HA05-HP358	30802725
12,55	14	124	77	60	45	SCD601-1255-2-2-140HA05-HP358	30802726
12,70	14	124	77	60	45	SCD601-1270-2-2-140HA05-HP358	30802727
12,80	14	124	77	60	45	SCD601-1280-2-2-140HA05-HP358	30802728
12,90	14	124	77	60	45	SCD601-1290-2-2-140HA05-HP358	30802729
13,00	14	124	77	60	45	SCD601-1300-2-2-140HA05-HP358	30802730
13,10	14	124	77	60	45	SCD601-1310-2-2-140HA05-HP358	30802731
13,30	14	124	77	60	45	SCD601-1330-2-2-140HA05-HP358	30802732
13,35	14	124	77	60	45	SCD601-1335-2-2-140HA05-HP358	30802733
13,50	14	124	77	60	45	SCD601-1350-2-2-140HA05-HP358	30802734
13,70	14	124	77	60	45	SCD601-1370-2-2-140HA05-HP358	30802735
13,80	14	124	77	60	45	SCD601-1380-2-2-140HA05-HP358	30802736
14,00	14	124	77	60	45	SCD601-1400-2-2-140HA05-HP358	30802737
14,20	16	133	83	63	48	SCD601-1420-2-2-140HA05-HP358	30802738
14,50	16	133	83	63	48	SCD601-1450-2-2-140HA05-HP358	30802739
14,80	16	133	83	63	48	SCD601-1480-2-2-140HA05-HP358	30802740
15,00	16	133	83	63	48	SCD601-1500-2-2-140HA05-HP358	30802741
15,10	16	133	83	63	48	SCD601-1510-2-2-140HA05-HP358	30802742
15,25	16	133	83	63	48	SCD601-1525-2-2-140HA05-HP358	30802743
15,30	16	133	83	63	48	SCD601-1530-2-2-140HA05-HP358	30802744
15,35	16	133	83	63	48	SCD601-1535-2-2-140HA05-HP358	30802745
15,50	16	133	83	63	48	SCD601-1550-2-2-140HA05-HP358	30802746
15,60	16	133	83	63	48	SCD601-1560-2-2-140HA05-HP358	30802747
15,80	16	133	83	63	48	SCD601-1580-2-2-140HA05-HP358	30802748
16,00	16	133	83	63	48	SCD601-1600-2-2-140HA05-HP358	30802749
16,05	18	143	93	71	48	SCD601-1605-2-2-140HA05-HP358	30802750
16,50	18	143	93	71	48	SCD601-1650-2-2-140HA05-HP358	30802751
16,80	18	143	93	71	48	SCD601-1680-2-2-140HA05-HP358	30802752
16,90	18	143	93	71	48	SCD601-1690-2-2-140HA05-HP358	30802753
17,00	18	143	93	71	48	SCD601-1700-2-2-140HA05-HP358	30802754

Continued on next page.

MEGA-Drill-Steel-Plus | Solid carbide twist drill SCD601 (5xD), internal coolant supply

Configurable features



Diameter:
Diameter in increments of
0.01 mm freely selectable



Shank form:
Shank form: HB | HE

Specification:

SCD601-[diameter]-3-3-140[shank form]05-HP358

Example:

SCD601-0431-3-3-140HE05-HP358

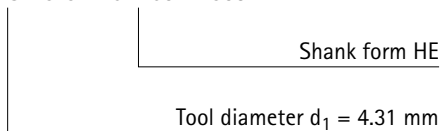

Dimensions of configurable series

d ₁ min.	d ₁ max.	d ₂ h6	l ₁	l ₂	l ₃	l ₄
3,00	3,70	6	66	28	23	36
3,71	4,70	6	74	36	29	36
4,71	6,00	6	82	44	35	36
6,01	8,00	8	91	53	43	36
8,01	10,00	10	103	61	49	40
10,01	12,00	12	118	71	56	45
12,01	14,00	14	124	77	60	45
14,01	16,00	16	133	83	63	48
16,01	18,00	18	143	93	71	48
18,01	20,00	20	153	101	77	50
20,01	22,00	25	200	135	110	56
22,01	25,00	25	200	140	120	56

Dimensions in mm.

* Particularly suitable for the premanufacturing of core bores for thread formers.

For cutting data recommendations, see end of chapter.

Special designs and other coatings available upon request.

MEGA-Drill-Steel-Plus

Solid carbide twist drill

SCD601 (8xD), internal coolant supply, follow-up product to the MEGA-Drill-Steel (SCD10)

Design:

Drill diameter: 3.00 – 20.00 mm
 Bore tolerance: \geq IT 9
 Cutting material: HP358
 Number of cutting edges: 2
 Number of guiding chamfers: 2
 Tip angle: 135°
 Helix angle: 30°

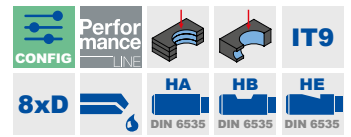
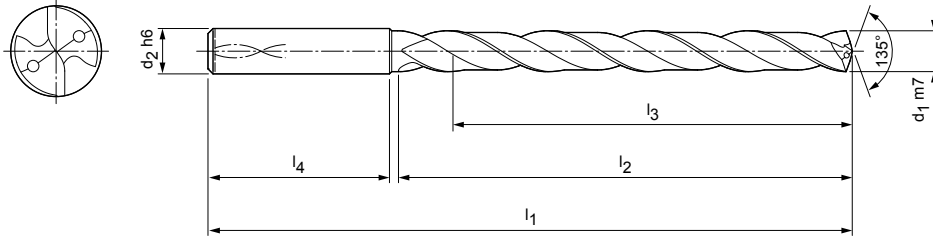

Stocked preferred series in shank form HA

Dimensions						Shank form HA	
d ₁ m7	d ₂ h6	l ₁	l ₂	l ₃	l ₄	Specification	Order no.
3,00	6	72	34	29	36	SCD601-0300-2-2-135HA08-HP358	30803112
3,10	6	72	34	29	36	SCD601-0310-2-2-135HA08-HP358	30803113
3,20	6	72	34	29	36	SCD601-0320-2-2-135HA08-HP358	30803114
3,30	6	72	34	29	36	SCD601-0330-2-2-135HA08-HP358	30803115
3,40	6	72	34	29	36	SCD601-0340-2-2-135HA08-HP358	30803116
3,50	6	72	34	29	36	SCD601-0350-2-2-135HA08-HP358	30803117
3,60	6	72	34	29	36	SCD601-0360-2-2-135HA08-HP358	30803118
3,70	6	72	34	29	36	SCD601-0370-2-2-135HA08-HP358	30803119
3,80	6	81	43	36	36	SCD601-0380-2-2-135HA08-HP358	30803120
3,90	6	81	43	36	36	SCD601-0390-2-2-135HA08-HP358	30803121
4,00	6	81	43	36	36	SCD601-0400-2-2-135HA08-HP358	30803122
4,10	6	81	43	36	36	SCD601-0410-2-2-135HA08-HP358	30803123
4,20	6	81	43	36	36	SCD601-0420-2-2-135HA08-HP358	30803124
4,30	6	81	43	36	36	SCD601-0430-2-2-135HA08-HP358	30803125
4,40	6	81	43	36	36	SCD601-0440-2-2-135HA08-HP358	30803126
4,50	6	81	43	36	36	SCD601-0450-2-2-135HA08-HP358	30803127
4,60	6	81	43	36	36	SCD601-0460-2-2-135HA08-HP358	30803128
4,70	6	81	43	36	36	SCD601-0470-2-2-135HA08-HP358	30803129
4,80	6	95	57	48	36	SCD601-0480-2-2-135HA08-HP358	30803130
4,90	6	95	57	48	36	SCD601-0490-2-2-135HA08-HP358	30803131
5,00	6	95	57	48	36	SCD601-0500-2-2-135HA08-HP358	30803132
5,10	6	95	57	48	36	SCD601-0510-2-2-135HA08-HP358	30803133
5,20	6	95	57	48	36	SCD601-0520-2-2-135HA08-HP358	30803134
5,30	6	95	57	48	36	SCD601-0530-2-2-135HA08-HP358	30803135
5,40	6	95	57	48	36	SCD601-0540-2-2-135HA08-HP358	30803136
5,50	6	95	57	48	36	SCD601-0550-2-2-135HA08-HP358	30803137
5,60	6	95	57	48	36	SCD601-0560-2-2-135HA08-HP358	30803138
5,70	6	95	57	48	36	SCD601-0570-2-2-135HA08-HP358	30803139
5,80	6	95	57	48	36	SCD601-0580-2-2-135HA08-HP358	30803140
5,90	6	95	57	48	36	SCD601-0590-2-2-135HA08-HP358	30803141
6,00	6	95	57	48	36	SCD601-0600-2-2-135HA08-HP358	30803142
6,10	8	114	76	64	36	SCD601-0610-2-2-135HA08-HP358	30803143
6,20	8	114	76	64	36	SCD601-0620-2-2-135HA08-HP358	30803144
6,30	8	114	76	64	36	SCD601-0630-2-2-135HA08-HP358	30803145
6,40	8	114	76	64	36	SCD601-0640-2-2-135HA08-HP358	30803146

MEGA-Drill-Steel-Plus | Solid carbide twist drill SCD601 (8xD), internal coolant supply

Dimensions						Shank form HA	
d ₁ m7	d ₂ h6	l ₁	l ₂	l ₃	l ₄	Specification	Order no.
6,50	8	114	76	64	36	SCD601-0650-2-2-135HA08-HP358	30803147
6,60	8	114	76	64	36	SCD601-0660-2-2-135HA08-HP358	30803148
6,70	8	114	76	64	36	SCD601-0670-2-2-135HA08-HP358	30803149
6,80	8	114	76	64	36	SCD601-0680-2-2-135HA08-HP358	30803150
6,90	8	114	76	64	36	SCD601-0690-2-2-135HA08-HP358	30803151
7,00	8	114	76	64	36	SCD601-0700-2-2-135HA08-HP358	30803152
7,10	8	114	76	64	36	SCD601-0710-2-2-135HA08-HP358	30803153
7,20	8	114	76	64	36	SCD601-0720-2-2-135HA08-HP358	30803154
7,30	8	114	76	64	36	SCD601-0730-2-2-135HA08-HP358	30803155
7,40	8	114	76	64	36	SCD601-0740-2-2-135HA08-HP358	30803156
7,50	8	114	76	64	36	SCD601-0750-2-2-135HA08-HP358	30803157
7,60	8	114	76	64	36	SCD601-0760-2-2-135HA08-HP358	30803158
7,70	8	114	76	64	36	SCD601-0770-2-2-135HA08-HP358	30803159
7,80	8	114	76	64	36	SCD601-0780-2-2-135HA08-HP358	30803160
7,90	8	114	76	64	36	SCD601-0790-2-2-135HA08-HP358	30803161
8,00	8	114	76	64	36	SCD601-0800-2-2-135HA08-HP358	30803162
8,10	10	142	95	80	40	SCD601-0810-2-2-135HA08-HP358	30803163
8,20	10	142	95	80	40	SCD601-0820-2-2-135HA08-HP358	30803164
8,40	10	142	95	80	40	SCD601-0840-2-2-135HA08-HP358	30803166
8,50	10	142	95	80	40	SCD601-0850-2-2-135HA08-HP358	30803167
8,60	10	142	95	80	40	SCD601-0860-2-2-135HA08-HP358	30803168
8,70	10	142	95	80	40	SCD601-0870-2-2-135HA08-HP358	30803169
8,80	10	142	95	80	40	SCD601-0880-2-2-135HA08-HP358	30803170
8,90	10	142	95	80	40	SCD601-0890-2-2-135HA08-HP358	30803171
9,00	10	142	95	80	40	SCD601-0900-2-2-135HA08-HP358	30803172
9,10	10	142	95	80	40	SCD601-0910-2-2-135HA08-HP358	30803173
9,20	10	142	95	80	40	SCD601-0920-2-2-135HA08-HP358	30803174
9,30	10	142	95	80	40	SCD601-0930-2-2-135HA08-HP358	30803175
9,40	10	142	95	80	40	SCD601-0940-2-2-135HA08-HP358	30803176
9,50	10	142	95	80	40	SCD601-0950-2-2-135HA08-HP358	30803177
9,60	10	142	95	80	40	SCD601-0960-2-2-135HA08-HP358	30803178
9,80	10	142	95	80	40	SCD601-0980-2-2-135HA08-HP358	30803180
9,90	10	142	95	80	40	SCD601-0990-2-2-135HA08-HP358	30803181
10,00	10	142	95	80	40	SCD601-1000-2-2-135HA08-HP358	30803182
10,10	12	162	114	96	45	SCD601-1010-2-2-135HA08-HP358	30803183
10,20	12	162	114	96	45	SCD601-1020-2-2-135HA08-HP358	30803184
10,30	12	162	114	95	45	SCD601-1030-2-2-135HA08-HP358	30803185
10,40	12	162	114	96	45	SCD601-1040-2-2-135HA08-HP358	30803186
10,50	12	162	114	96	45	SCD601-1050-2-2-135HA08-HP358	30803187
10,70	12	162	114	96	45	SCD601-1070-2-2-135HA08-HP358	30803189
10,80	12	162	114	96	45	SCD601-1080-2-2-135HA08-HP358	30803190
11,00	12	162	114	96	45	SCD601-1100-2-2-135HA08-HP358	30803192
11,10	12	162	114	96	45	SCD601-1110-2-2-135HA08-HP358	30803193
11,20	12	162	114	96	45	SCD601-1120-2-2-135HA08-HP358	30803194
11,30	12	162	114	96	45	SCD601-1130-2-2-135HA08-HP358	30803195
11,40	12	162	114	96	45	SCD601-1140-2-2-135HA08-HP358	30803196
11,50	12	162	114	96	45	SCD601-1150-2-2-135HA08-HP358	30803197
11,80	12	162	114	96	45	SCD601-1180-2-2-135HA08-HP358	30803200
12,00	12	162	114	96	45	SCD601-1200-2-2-135HA08-HP358	30803202
12,50	14	178	133	112	45	SCD601-1250-2-2-135HA08-HP358	30803203
12,80	14	178	133	112	45	SCD601-1280-2-2-135HA08-HP358	30803204
13,00	14	178	133	112	45	SCD601-1300-2-2-135HA08-HP358	30803205
13,50	14	178	133	112	45	SCD601-1350-2-2-135HA08-HP358	30803206
13,80	14	178	133	112	45	SCD601-1380-2-2-135HA08-HP358	30803207
14,00	14	178	133	112	45	SCD601-1400-2-2-135HA08-HP358	30803208
14,50	16	203	152	128	48	SCD601-1450-2-2-135HA08-HP358	30803209
14,80	16	203	152	128	48	SCD601-1480-2-2-135HA08-HP358	30803210

MEGA-Drill-Steel-Plus | Solid carbide twist drill SCD601 (8xD), internal coolant supply

Dimensions						Shank form HA	
d ₁ m7	d ₂ h6	l ₁	l ₂	l ₃	l ₄	Specification	Order no.
15,00	16	203	152	128	48	SCD601-1500-2-2-135HA08-HP358	30803211
15,50	16	203	152	128	48	SCD601-1550-2-2-135HA08-HP358	30803212
15,80	16	203	152	128	48	SCD601-1580-2-2-135HA08-HP358	30803213
16,00	16	203	152	128	48	SCD601-1600-2-2-135HA08-HP358	30803214
17,00	18	222	171	144	48	SCD601-1700-2-2-135HA08-HP358	30803217
17,50	18	222	171	144	48	SCD601-1750-2-2-135HA08-HP358	30803218
17,80	18	222	171	144	48	SCD601-1780-2-2-135HA08-HP358	30803219
18,00	18	222	171	144	48	SCD601-1800-2-2-135HA08-HP358	30803220
18,50	20	243	190	160	50	SCD601-1850-2-2-135HA08-HP358	30803221
18,80	20	243	190	160	50	SCD601-1880-2-2-135HA08-HP358	30803222
19,50	20	243	190	160	50	SCD601-1950-2-2-135HA08-HP358	30803224
19,80	20	243	190	160	50	SCD601-1980-2-2-135HA08-HP358	30803225
20,00	20	243	190	160	50	SCD601-2000-2-2-135HA08-HP358	30803226

Configurable features



Diameter:
Diameter in increments of
0.01 mm freely selectable



Shank form:
Shank form: HB | HE

Specification:

SCD601-[diameter]-2-2-135[shank form]08-HP358

Dimensions of configurable series

d ₁ min.	d ₁ max.	d ₂ h6	l ₁	l ₂	l ₃	l ₄
3,00	3,70	6	72	34	29	36
3,71	4,70	6	81	43	36	36
4,71	6,00	6	95	57	48	36
6,01	8,00	8	114	76	64	36
8,01	10,00	10	142	95	80	40
10,01	12,00	12	162	114	96	45
12,01	14,00	14	178	133	112	45
14,01	16,00	16	203	152	128	48
16,01	18,00	18	222	171	144	48
18,01	20,00	20	243	190	160	50

Example:

SCD601-0431-2-2-135HE08-HP358

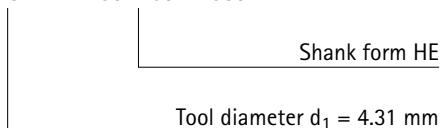

Dimensions in mm.

For cutting data recommendations, see end of chapter.

Special designs and other coatings available upon request.

MEGA-Quadro-Drill-Plus

Solid carbide twist drill

SCD610 (5xD), external coolant supply, follow-up product to the MEGA Quadro Drill (SCD16)

Design:

Drill diameter: 3.00 – 20.00 mm
 Bore tolerance: \geq IT 8
 Cutting material: HP358
 Number of cutting edges: 2
 Number of guiding chamfers: 4
 Tip angle: 140°
 Helix angle: 30°

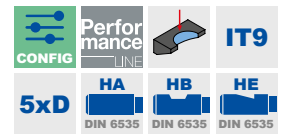
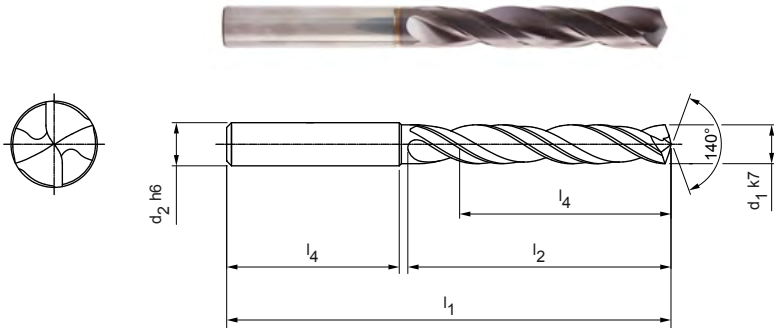

Stocked preferred series in shank form HA

Dimensions						Shank form HA	
d ₁ k7	d ₂ h6	l ₁	l ₂	l ₃	l ₄	Specification	Order no.
3,00	6	66	28	23	36	SCD610-0300-2-4-140HA05-HP358	31052631
3,10	6	66	28	23	36	SCD610-0310-2-4-140HA05-HP358	31052632
3,20	6	66	28	23	36	SCD610-0320-2-4-140HA05-HP358	31052633
3,30	6	66	28	23	36	SCD610-0330-2-4-140HA05-HP358	31052634
3,40	6	66	28	23	36	SCD610-0340-2-4-140HA05-HP358	31052635
3,50	6	66	28	23	36	SCD610-0350-2-4-140HA05-HP358	31052636
3,70	6	66	28	23	36	SCD610-0370-2-4-140HA05-HP358	31052638
4,00	6	74	36	29	36	SCD610-0400-2-4-140HA05-HP358	31052641
4,20	6	74	36	29	36	SCD610-0420-2-4-140HA05-HP358	31052643
4,30	6	74	36	29	36	SCD610-0430-2-4-140HA05-HP358	31052644
4,50	6	74	36	29	36	SCD610-0450-2-4-140HA05-HP358	31052646
4,80	6	82	44	35	36	SCD610-0480-2-4-140HA05-HP358	31052649
5,00	6	82	44	35	36	SCD610-0500-2-4-140HA05-HP358	31052651
5,10	6	82	44	35	36	SCD610-0510-2-4-140HA05-HP358	31052652
5,20	6	82	44	35	36	SCD610-0520-2-4-140HA05-HP358	31052653
5,50	6	82	44	35	36	SCD610-0550-2-4-140HA05-HP358	31052656
5,60	6	82	44	35	36	SCD610-0560-2-4-140HA05-HP358	31052657
5,80	6	82	44	35	36	SCD610-0580-2-4-140HA05-HP358	31052659
6,00	6	82	44	35	36	SCD610-0600-2-4-140HA05-HP358	31052661
6,40	8	91	53	43	36	SCD610-0640-2-4-140HA05-HP358	31052665
6,50	8	91	53	43	36	SCD610-0650-2-4-140HA05-HP358	31052666
6,80	8	91	53	43	36	SCD610-0680-2-4-140HA05-HP358	31052669
6,90	8	91	53	43	36	SCD610-0690-2-4-140HA05-HP358	31052670
7,00	8	91	53	43	36	SCD610-0700-2-4-140HA05-HP358	31052671
7,40	8	91	53	43	36	SCD610-0740-2-4-140HA05-HP358	31052675
7,50	8	91	53	43	36	SCD610-0750-2-4-140HA05-HP358	31052676
7,80	8	91	53	43	36	SCD610-0780-2-4-140HA05-HP358	31052679
8,00	8	91	53	43	36	SCD610-0800-2-4-140HA05-HP358	31052681
8,50	10	103	61	49	40	SCD610-0850-2-4-140HA05-HP358	31052686
8,60	10	103	61	49	40	SCD610-0860-2-4-140HA05-HP358	31052687
8,80	10	103	61	49	40	SCD610-0880-2-4-140HA05-HP358	31052689
9,00	10	103	61	49	40	SCD610-0900-2-4-140HA05-HP358	31052691
9,50	10	103	61	49	40	SCD610-0950-2-4-140HA05-HP358	31052696
9,80	10	103	61	49	40	SCD610-0980-2-4-140HA05-HP358	31052699
10,00	10	103	61	49	40	SCD610-1000-2-4-140HA05-HP358	31052701

MEGA-Quadro-Drill-Plus | Solid carbide twist drills SCD610 (5xD), external coolant supply

Dimensions						Shank form HA	
d ₁ k7	d ₂ h6	l ₁	l ₂	l ₃	l ₄	Specification	Order no.
10,20	12	118	71	56	45	SCD610-1020-2-4-140HA05-HP358	31052703
10,30	12	118	71	56	45	SCD610-1030-2-4-140HA05-HP358	31052704
10,50	12	118	71	56	45	SCD610-1050-2-4-140HA05-HP358	31052706
10,90	12	118	71	56	45	SCD610-1090-2-4-140HA05-HP358	31052710
11,00	12	118	71	56	45	SCD610-1100-2-4-140HA05-HP358	31052711
11,50	12	118	71	56	45	SCD610-1150-2-4-140HA05-HP358	31052716
11,80	12	118	71	56	45	SCD610-1180-2-4-140HA05-HP358	31052719
12,00	12	118	71	56	45	SCD610-1200-2-4-140HA05-HP358	31052721
12,50	14	124	77	60	45	SCD610-1250-2-4-140HA05-HP358	31052722
13,00	14	124	77	60	45	SCD610-1300-2-4-140HA05-HP358	31052724
13,50	14	124	77	60	45	SCD610-1350-2-4-140HA05-HP358	31052725
14,00	14	124	77	60	45	SCD610-1400-2-4-140HA05-HP358	31052727
14,50	16	133	83	63	48	SCD610-1450-2-4-140HA05-HP358	31052728
15,00	16	133	83	63	48	SCD610-1500-2-4-140HA05-HP358	31052730
16,00	16	133	83	63	48	SCD610-1600-2-4-140HA05-HP358	31052733
17,00	18	143	93	71	48	SCD610-1700-2-4-140HA05-HP358	31052736
17,50	18	143	93	71	48	SCD610-1750-2-4-140HA05-HP358	31052737
18,00	18	143	93	71	48	SCD610-1800-2-4-140HA05-HP358	31052739
18,50	20	153	101	77	50	SCD610-1850-2-4-140HA05-HP358	31052740
20,00	20	153	101	77	50	SCD610-2000-2-4-140HA05-HP358	31052745

Configurable features



Diameter:
Diameter in increments of
0.01 mm freely selectable



Shank form:
Shank form: HB | HE

Specification:

SCD610-[diameter]-3-3-140[shank form]05-HP358

Dimensions of configurable series

d ₁ min.	d ₁ max.	d ₂ h6	l ₁	l ₂	l ₃	l ₄
3,00	3,70	6	66	28	23	36
3,71	4,70	6	74	36	29	36
4,71	6,00	6	82	44	35	36
6,01	8,00	8	91	53	43	36
8,01	10,00	10	103	61	49	40
10,01	12,00	12	118	71	56	45
12,01	14,00	14	124	77	60	45
14,01	16,00	16	133	83	63	48
16,01	18,00	18	143	93	71	48
18,01	20,00	20	153	101	77	50

Example:

SCD610-0431-3-3-140HE05-HP358

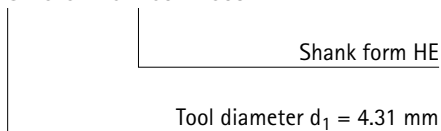

Dimensions in mm.

For cutting data recommendations, see end of chapter.

Special designs and other coatings available upon request.

MEGA-Quadro-Drill-Plus

Solid carbide twist drill

SCD611 (5xD), internal coolant supply, follow-up product to the MEGA Quadro Drill (SCD16)

Design:

Drill diameter: 3.00 – 20.00 mm
 Bore tolerance: ≥ IT 8
 Cutting material: HP358
 Number of cutting edges: 2
 Number of guiding chamfers: 4
 Tip angle: 140°
 Helix angle: 30°

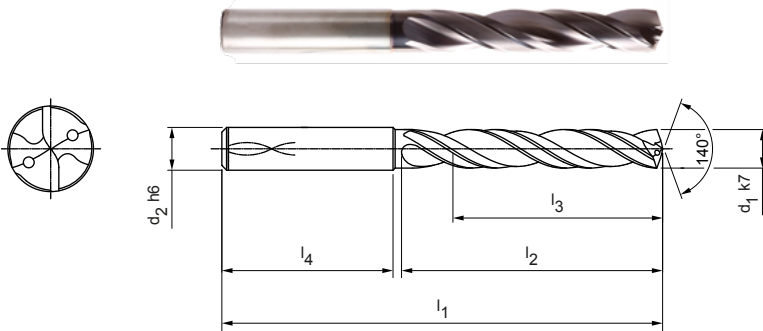

Stocked preferred series in shank form HA

Dimensions						Shank form HA	
d ₁ k7	d ₂ h6	l ₁	l ₂	l ₃	l ₄	Specification	Order no.
3,00	6	66	28	23	36	SCD611-0300-2-4-140HA05-HP358	31052795
3,10	6	66	28	23	36	SCD611-0310-2-4-140HA05-HP358	31052796
3,20	6	66	28	23	36	SCD611-0320-2-4-140HA05-HP358	31052797
3,30	6	66	28	23	36	SCD611-0330-2-4-140HA05-HP358	31052798
3,40	6	66	28	23	36	SCD611-0340-2-4-140HA05-HP358	31052799
3,50	6	66	28	23	36	SCD611-0350-2-4-140HA05-HP358	31052800
3,70	6	66	28	23	36	SCD611-0370-2-4-140HA05-HP358	31052802
3,80	6	74	36	29	36	SCD611-0380-2-4-140HA05-HP358	31052803
3,90	6	74	36	29	36	SCD611-0390-2-4-140HA05-HP358	31052804
4,00	6	74	36	29	36	SCD611-0400-2-4-140HA05-HP358	31052805
4,20	6	74	36	29	36	SCD611-0420-2-4-140HA05-HP358	31052807
4,30	6	74	36	29	36	SCD611-0430-2-4-140HA05-HP358	31052808
4,50	6	74	36	29	36	SCD611-0450-2-4-140HA05-HP358	31052810
4,80	6	82	44	35	36	SCD611-0480-2-4-140HA05-HP358	31052813
5,00	6	82	44	35	36	SCD611-0500-2-4-140HA05-HP358	31052815
5,10	6	82	44	35	36	SCD611-0510-2-4-140HA05-HP358	31052816
5,20	6	82	44	35	36	SCD611-0520-2-4-140HA05-HP358	31052817
5,30	6	82	44	35	36	SCD611-0530-2-4-140HA05-HP358	31052818
5,50	6	82	44	35	36	SCD611-0550-2-4-140HA05-HP358	31052820
5,60	6	82	44	35	36	SCD611-0560-2-4-140HA05-HP358	31052821
5,80	6	82	44	35	36	SCD611-0580-2-4-140HA05-HP358	31052823
5,90	6	82	44	35	36	SCD611-0590-2-4-140HA05-HP358	31052824
6,00	6	82	44	35	36	SCD611-0600-2-4-140HA05-HP358	31052825
6,40	8	91	53	43	36	SCD611-0640-2-4-140HA05-HP358	31052829
6,50	8	91	53	43	36	SCD611-0650-2-4-140HA05-HP358	31052830
6,60	8	91	53	43	36	SCD611-0660-2-4-140HA05-HP358	31052831
6,70	8	91	53	43	36	SCD611-0670-2-4-140HA05-HP358	31052832
6,80	8	91	53	43	36	SCD611-0680-2-4-140HA05-HP358	31052833
6,90	8	91	53	43	36	SCD611-0690-2-4-140HA05-HP358	31052834
7,00	8	91	53	43	36	SCD611-0700-2-4-140HA05-HP358	31052835
7,20	8	91	53	43	36	SCD611-0720-2-4-140HA05-HP358	31052837
7,40	8	91	53	43	36	SCD611-0740-2-4-140HA05-HP358	31052839
7,50	8	91	53	43	36	SCD611-0750-2-4-140HA05-HP358	31052840
7,80	8	91	53	43	36	SCD611-0780-2-4-140HA05-HP358	31052843
7,90	8	91	53	43	36	SCD611-0790-2-4-140HA05-HP358	31052844

MEGA-Quadro-Drill-Plus | Solid carbide twist drill SCD611 (5xD), internal coolant supply

Dimensions						Shank form HA	
d ₁ k7	d ₂ h6	l ₁	l ₂	l ₃	l ₄	Specification	Order no.
8,00	8	91	53	43	36	SCD611-0800-2-4-140HA05-HP358	31052845
8,10	10	103	61	49	40	SCD611-0810-2-4-140HA05-HP358	31052846
8,30	10	103	61	49	40	SCD611-0830-2-4-140HA05-HP358	31052848
8,40	10	103	61	49	40	SCD611-0840-2-4-140HA05-HP358	31052849
8,50	10	103	61	49	40	SCD611-0850-2-4-140HA05-HP358	31052850
8,60	10	103	61	49	40	SCD611-0860-2-4-140HA05-HP358	31052851
8,80	10	103	61	49	40	SCD611-0880-2-4-140HA05-HP358	31052853
9,00	10	103	61	49	40	SCD611-0900-2-4-140HA05-HP358	31052855
9,20	10	103	61	49	40	SCD611-0920-2-4-140HA05-HP358	31052857
9,30	10	103	61	49	40	SCD611-0930-2-4-140HA05-HP358	31052858
9,50	10	103	61	49	40	SCD611-0950-2-4-140HA05-HP358	31052860
9,80	10	103	61	49	40	SCD611-0980-2-4-140HA05-HP358	31052863
9,90	10	103	61	49	40	SCD611-0990-2-4-140HA05-HP358	31052864
10,00	10	103	61	49	40	SCD611-1000-2-4-140HA05-HP358	31052865
10,20	12	118	71	56	45	SCD611-1020-2-4-140HA05-HP358	31052867
10,30	12	118	71	56	45	SCD611-1030-2-4-140HA05-HP358	31052868
10,40	12	118	71	56	45	SCD611-1040-2-4-140HA05-HP358	31052869
10,50	12	118	71	56	45	SCD611-1050-2-4-140HA05-HP358	31052870
10,90	12	118	71	56	45	SCD611-1090-2-4-140HA05-HP358	31052874
11,00	12	118	71	56	45	SCD611-1100-2-4-140HA05-HP358	31052875
11,50	12	118	71	56	45	SCD611-1150-2-4-140HA05-HP358	31052880
11,70	12	118	71	56	45	SCD611-1170-2-4-140HA05-HP358	31052882
11,80	12	118	71	56	45	SCD611-1180-2-4-140HA05-HP358	31052883

Configurable features



Diameter:
Diameter in increments of
0.01 mm freely selectable



Shank form:
Shank form: HB | HE

Specification:

SCD611-[diameter]-3-3-140[shank form]05-HP358

Dimensions of configurable series

d ₁ min.	d ₁ max.	d ₂ h6	l ₁	l ₂	l ₃	l ₄
3,00	3,70	6	66	28	23	36
3,71	4,70	6	74	36	29	36
4,71	6,00	6	82	44	35	36
6,01	8,00	8	91	53	43	36
8,01	10,00	10	103	61	49	40
10,01	12,00	12	118	71	56	45
12,01	14,00	14	124	77	60	45
14,01	16,00	16	133	83	63	48
16,01	18,00	18	143	93	71	48
18,01	20,00	20	153	101	77	50

Example:

SCD611-0431-3-3-140HE05-HP358

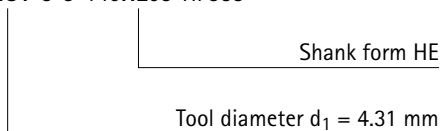

Dimensions in mm.

For cutting data recommendations, see end of chapter.

Special designs and other coatings available upon request.

MEGA-Quadro-Drill-Plus

Solid carbide twist drill

SCD611 (8xD), internal coolant supply, follow-up product to the MEGA Quadro Drill (SCD16)

Design:

Drill diameter: 3.00 – 20.00 mm
 Bore tolerance: \geq IT 8
 Cutting material: HP358
 Number of cutting edges: 2
 Number of guiding chamfers: 4
 Tip angle: 140°
 Helix angle: 30°

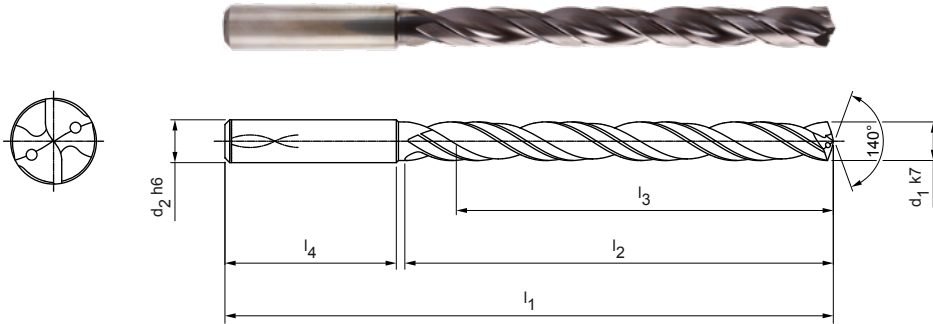

Stocked preferred series in shank form HA

Dimensions						Shank form HA	
d ₁ k7	d ₂ h6	l ₁	l ₂	l ₃	l ₄	Specification	Order no.
3,00	6	72	34	29	36	SCD611-0300-2-4-140HA08-HP358	31052910
3,10	6	72	34	29	36	SCD611-0310-2-4-140HA08-HP358	31052911
3,20	6	72	34	29	36	SCD611-0320-2-4-140HA08-HP358	31052912
3,30	6	72	34	29	36	SCD611-0330-2-4-140HA08-HP358	31052913
3,40	6	72	34	29	36	SCD611-0340-2-4-140HA08-HP358	31052914
3,50	6	72	34	29	36	SCD611-0350-2-4-140HA08-HP358	31052915
3,60	6	72	34	29	36	SCD611-0360-2-4-140HA08-HP358	31052916
3,70	6	72	34	29	36	SCD611-0370-2-4-140HA08-HP358	31052917
3,80	6	81	43	36	36	SCD611-0380-2-4-140HA08-HP358	31052918
3,90	6	81	43	36	36	SCD611-0390-2-4-140HA08-HP358	31052919
4,00	6	81	43	36	36	SCD611-0400-2-4-140HA08-HP358	31052920
4,10	6	81	43	36	36	SCD611-0410-2-4-140HA08-HP358	31052921
4,20	6	81	43	36	36	SCD611-0420-2-4-140HA08-HP358	31052922
4,30	6	81	43	36	36	SCD611-0430-2-4-140HA08-HP358	31052923
4,40	6	81	43	36	36	SCD611-0440-2-4-140HA08-HP358	31052924
4,50	6	81	43	36	36	SCD611-0450-2-4-140HA08-HP358	31052925
4,60	6	81	43	36	36	SCD611-0460-2-4-140HA08-HP358	31052926
4,80	6	95	57	48	36	SCD611-0480-2-4-140HA08-HP358	31052928
4,90	6	95	57	48	36	SCD611-0490-2-4-140HA08-HP358	31052929
5,00	6	95	57	48	36	SCD611-0500-2-4-140HA08-HP358	31052930
5,10	6	95	57	48	36	SCD611-0510-2-4-140HA08-HP358	31052931
5,20	6	95	57	48	36	SCD611-0520-2-4-140HA08-HP358	31052932
5,40	6	95	57	48	36	SCD611-0540-2-4-140HA08-HP358	31052934
5,50	6	95	57	48	36	SCD611-0550-2-4-140HA08-HP358	31052935
5,60	6	95	57	48	36	SCD611-0560-2-4-140HA08-HP358	31052936
5,70	6	95	57	48	36	SCD611-0570-2-4-140HA08-HP358	31052937
5,80	6	95	57	48	36	SCD611-0580-2-4-140HA08-HP358	31052938
6,00	6	95	57	48	36	SCD611-0600-2-4-140HA08-HP358	31052940
6,10	8	114	76	64	36	SCD611-0610-2-4-140HA08-HP358	31052941
6,20	8	114	76	64	36	SCD611-0620-2-4-140HA08-HP358	31052942
6,50	8	114	76	64	36	SCD611-0650-2-4-140HA08-HP358	31052945
6,60	8	114	76	64	36	SCD611-0660-2-4-140HA08-HP358	31052946
6,80	8	114	76	64	36	SCD611-0680-2-4-140HA08-HP358	31052948
6,90	8	114	76	64	36	SCD611-0690-2-4-140HA08-HP358	31052949
7,00	8	114	76	64	36	SCD611-0700-2-4-140HA08-HP358	31052950

MEGA-Quadro-Drill-Plus | Solid carbide twist drill SCD611 (8xD), internal coolant supply

Dimensions						Shank form HA	
d ₁ k7	d ₂ h6	l ₁	l ₂	l ₃	l ₄	Specification	Order no.
7,20	8	114	76	64	36	SCD611-0720-2-4-140HA08-HP358	31052952
7,40	8	114	76	64	36	SCD611-0740-2-4-140HA08-HP358	31052954
7,50	8	114	76	64	36	SCD611-0750-2-4-140HA08-HP358	31052955
7,60	8	114	76	64	36	SCD611-0760-2-4-140HA08-HP358	31052956
7,80	8	114	76	64	36	SCD611-0780-2-4-140HA08-HP358	31052958
8,00	8	114	76	64	36	SCD611-0800-2-4-140HA08-HP358	31052960
8,20	10	142	95	80	40	SCD611-0820-2-4-140HA08-HP358	31052962
8,50	10	142	95	80	40	SCD611-0850-2-4-140HA08-HP358	31052965
8,60	10	142	95	80	40	SCD611-0860-2-4-140HA08-HP358	31052966
8,70	10	142	95	80	40	SCD611-0870-2-4-140HA08-HP358	31052967
8,90	10	142	95	80	40	SCD611-0890-2-4-140HA08-HP358	31052969
9,00	10	142	95	80	40	SCD611-0900-2-4-140HA08-HP358	31052970
9,50	10	142	95	80	40	SCD611-0950-2-4-140HA08-HP358	31052975
9,60	10	142	95	80	40	SCD611-0960-2-4-140HA08-HP358	31052976
9,70	10	142	95	80	40	SCD611-0970-2-4-140HA08-HP358	31052977
9,80	10	142	95	80	40	SCD611-0980-2-4-140HA08-HP358	31052978
9,90	10	142	95	80	40	SCD611-0990-2-4-140HA08-HP358	31052979
10,00	10	142	95	80	40	SCD611-1000-2-4-140HA08-HP358	31052980
10,10	12	162	114	96	45	SCD611-1010-2-4-140HA08-HP358	31052981
10,20	12	162	114	96	45	SCD611-1020-2-4-140HA08-HP358	31052982
10,50	12	162	114	96	45	SCD611-1050-2-4-140HA08-HP358	31052985
10,60	12	162	114	96	45	SCD611-1060-2-4-140HA08-HP358	31052986
10,70	12	162	114	96	45	SCD611-1070-2-4-140HA08-HP358	31052987
11,00	12	162	114	96	45	SCD611-1100-2-4-140HA08-HP358	31052990
11,30	12	162	114	96	45	SCD611-1130-2-4-140HA08-HP358	31052993
11,70	12	162	114	96	45	SCD611-1170-2-4-140HA08-HP358	31052997
11,80	12	162	114	96	45	SCD611-1180-2-4-140HA08-HP358	31052998
12,00	12	162	114	96	45	SCD611-1200-2-4-140HA08-HP358	31053000
12,50	14	178	133	112	45	SCD611-1250-2-4-140HA08-HP358	31053001
12,80	14	178	133	112	45	SCD611-1280-2-4-140HA08-HP358	31053002
13,00	14	178	133	112	45	SCD611-1300-2-4-140HA08-HP358	31053003
13,50	14	178	133	112	45	SCD611-1350-2-4-140HA08-HP358	31053004
14,00	14	178	133	112	45	SCD611-1400-2-4-140HA08-HP358	31053006
15,00	16	203	152	128	48	SCD611-1500-2-4-140HA08-HP358	31053009
15,80	16	203	152	128	48	SCD611-1580-2-4-140HA08-HP358	31053011
16,00	16	203	152	128	48	SCD611-1600-2-4-140HA08-HP358	31053012
16,50	18	222	171	144	48	SCD611-1650-2-4-140HA08-HP358	31053013
20,00	20	243	190	160	50	SCD611-2000-2-4-140HA08-HP358	31053024

Configurable features



Diameter:
Diameter in increments of
0.01 mm freely selectable



Shank form:
Shank form: HB | HE

Specification:

SCD611-[diameter]-3-3-140[shank form]08-HP358

Dimensions of configurable series

d ₁ min.	d ₁ max.	d ₂ h6	l ₁	l ₂	l ₃	l ₄
3,00	3,70	6	72	34	29	36
3,71	4,70	6	81	43	36	36
4,71	6,00	6	95	57	48	36
6,01	8,00	8	114	76	64	36
8,01	10,00	10	142	95	80	40
10,01	12,00	12	162	114	96	45
12,01	14,00	14	178	133	112	45
14,01	16,00	16	203	152	128	48
16,01	18,00	18	222	171	144	48
18,01	20,00	20	243	190	160	50

Example:

SCD611-0431-2-4-140HE08-HP358

Shank form HE

Tool diameter d₁ = 4.31 mm

Dimensions in mm.

For cutting data recommendations, see end of chapter.

Special designs and other coatings available upon request.

MEGA-Quadro-Drill-Plus

Solid carbide twist drill

SCD611 (12xD), internal coolant supply, follow-up product to the MEGA Quadro Drill (SCD16)

Design:

Drill diameter: 3.00 – 20.00 mm
 Bore tolerance: \geq IT 8
 Cutting material: HP358
 Number of cutting edges: 2
 Number of guiding chamfers: 4
 Tip angle: 140°
 Helix angle: 30°

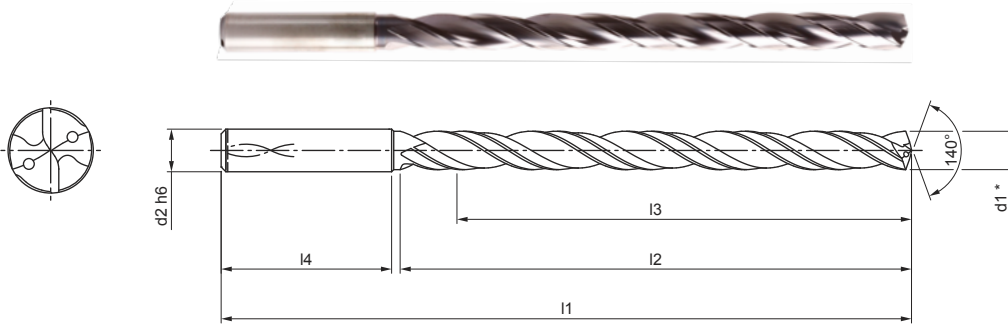

Stocked preferred series in shank form HA

Dimensions						Shank form HA	
d ₁ k7	d ₂ h6	l ₁	l ₂	l ₃	l ₄	Specification	Order no.
3,00	6	92	54	48	36	SCD611-0300-2-4-140HA12-HP358	31053025
3,10	6	92	54	48	36	SCD611-0310-2-4-140HA12-HP358	31053026
3,20	6	92	54	48	36	SCD611-0320-2-4-140HA12-HP358	31053027
3,30	6	92	54	48	36	SCD611-0330-2-4-140HA12-HP358	31053028
3,40	6	92	54	48	36	SCD611-0340-2-4-140HA12-HP358	31053029
3,50	6	92	54	48	36	SCD611-0350-2-4-140HA12-HP358	31053030
3,60	6	92	54	48	36	SCD611-0360-2-4-140HA12-HP358	31053031
3,70	6	92	54	48	36	SCD611-0370-2-4-140HA12-HP358	31053032
3,80	6	102	64	58	36	SCD611-0380-2-4-140HA12-HP358	31053033
3,90	6	102	64	58	36	SCD611-0390-2-4-140HA12-HP358	31053034
4,00	6	102	64	58	36	SCD611-0400-2-4-140HA12-HP358	31053035
4,05	6	102	64	58	36	SCD611-0405-2-4-140HA12-HP358	31300718
4,10	6	102	64	58	36	SCD611-0410-2-4-140HA12-HP358	31053036
4,20	6	102	64	58	36	SCD611-0420-2-4-140HA12-HP358	31053037
4,30	6	102	64	58	36	SCD611-0430-2-4-140HA12-HP358	31053038
4,40	6	102	64	58	36	SCD611-0440-2-4-140HA12-HP358	31053039
4,50	6	102	64	58	36	SCD611-0450-2-4-140HA12-HP358	31053040
4,60	6	102	64	58	36	SCD611-0460-2-4-140HA12-HP358	31053041
4,65	6	116	78	58	36	SCD611-0465-2-4-140HA12-HP358	31179333
4,70	6	102	64	58	36	SCD611-0470-2-4-140HA12-HP358	31053042
4,80	6	116	78	70	36	SCD611-0480-2-4-140HA12-HP358	31053043
5,00	6	116	78	70	36	SCD611-0500-2-4-140HA12-HP358	31053045
5,05	6	116	78	70	36	SCD611-0505-2-4-140HA12-HP358	31245107
5,10	6	116	78	70	36	SCD611-0510-2-4-140HA12-HP358	31053046
5,20	6	116	78	70	36	SCD611-0520-2-4-140HA12-HP358	31053047
5,40	6	116	78	70	36	SCD611-0540-2-4-140HA12-HP358	31053049
5,50	6	116	78	70	36	SCD611-0550-2-4-140HA12-HP358	31053050
5,60	6	116	78	70	36	SCD611-0560-2-4-140HA12-HP358	31053051
5,70	6	116	78	70	36	SCD611-0570-2-4-140HA12-HP358	31053052
5,80	6	116	78	70	36	SCD611-0580-2-4-140HA12-HP358	31053053
6,00	6	116	78	70	36	SCD611-0600-2-4-140HA12-HP358	31053055
6,10	8	146	108	94	36	SCD611-0610-2-4-140HA12-HP358	31053056
6,40	8	146	108	94	36	SCD611-0640-2-4-140HA12-HP358	31053059
6,50	8	146	108	94	36	SCD611-0650-2-4-140HA12-HP358	31053060
6,80	8	146	108	94	36	SCD611-0680-2-4-140HA12-HP358	31053063

MEGA-Quadro-Drill-Plus | Solid carbide twist drill SCD611 (12xD), internal coolant supply

Dimensions						Shank form HA	
d ₁ k7	d ₂ h6	l ₁	l ₂	l ₃	l ₄	Specification	Order no.
6,90	8	146	108	94	36	SCD611-0690-2-4-140HA12-HP358	31053064
7,00	8	146	108	94	36	SCD611-0700-2-4-140HA12-HP358	31053065
7,10	8	146	108	94	36	SCD611-0710-2-4-140HA12-HP358	31053066
7,50	8	146	108	94	36	SCD611-0750-2-4-140HA12-HP358	31053070
7,60	8	146	108	94	36	SCD611-0760-2-4-140HA12-HP358	31053071
7,70	8	146	108	94	36	SCD611-0770-2-4-140HA12-HP358	31053072
7,80	8	146	108	94	36	SCD611-0780-2-4-140HA12-HP358	31053073
7,90	8	146	108	94	36	SCD611-0790-2-4-140HA12-HP358	31053074
8,00	8	146	108	94	36	SCD611-0800-2-4-140HA12-HP358	31053075
8,20	10	162	120	110	40	SCD611-0820-2-4-140HA12-HP358	31053077
8,30	10	162	120	110	40	SCD611-0830-2-4-140HA12-HP358	31053078
8,40	10	162	120	110	40	SCD611-0840-2-4-140HA12-HP358	31053079
8,50	10	162	120	110	40	SCD611-0850-2-4-140HA12-HP358	31053080
8,60	10	162	120	110	40	SCD611-0860-2-4-140HA12-HP358	31053081
8,70	10	162	120	110	40	SCD611-0870-2-4-140HA12-HP358	31053082
9,00	10	162	120	110	40	SCD611-0900-2-4-140HA12-HP358	31053085
9,50	10	162	120	110	40	SCD611-0950-2-4-140HA12-HP358	31053090
9,60	10	162	120	110	40	SCD611-0960-2-4-140HA12-HP358	31053091
9,80	10	162	120	110	40	SCD611-0980-2-4-140HA12-HP358	31053093
9,90	10	162	120	110	40	SCD611-0990-2-4-140HA12-HP358	31053094
10,00	10	162	120	110	40	SCD611-1000-2-4-140HA12-HP358	31053095
10,20	12	204	156	142	45	SCD611-1020-2-4-140HA12-HP358	31053097
10,50	12	204	156	142	45	SCD611-1050-2-4-140HA12-HP358	31053100
10,60	12	204	156	142	45	SCD611-1060-2-4-140HA12-HP358	31053101
11,00	12	204	156	142	45	SCD611-1100-2-4-140HA12-HP358	31053105
11,20	12	204	156	142	45	SCD611-1120-2-4-140HA12-HP358	31053107
11,70	12	204	156	142	45	SCD611-1170-2-4-140HA12-HP358	31053112
11,80	12	204	156	142	45	SCD611-1180-2-4-140HA12-HP358	31053113
12,00	12	204	156	142	45	SCD611-1200-2-4-140HA12-HP358	31053115
12,50	14	230	182	166	45	SCD611-1250-2-4-140HA12-HP358	31053116
13,00	14	230	182	166	45	SCD611-1300-2-4-140HA12-HP358	31053118
13,50	14	230	182	166	45	SCD611-1350-2-4-140HA12-HP358	31053119
14,00	14	230	182	166	45	SCD611-1400-2-4-140HA12-HP358	31053121
14,50	16	260	208	192	48	SCD611-1450-2-4-140HA12-HP358	31053122
15,00	16	260	208	192	48	SCD611-1500-2-4-140HA12-HP358	31053124
16,00	16	260	208	192	48	SCD611-1600-2-4-140HA12-HP358	31053127
16,50	18	285	234	216	48	SCD611-1650-2-4-140HA12-HP358	31053128
17,50	18	285	234	216	48	SCD611-1750-2-4-140HA12-HP358	31053131
19,50	20	310	258	240	50	SCD611-1950-2-4-140HA12-HP358	31053137

Continued on next page.

MEGA-Quadro-Drill-Plus | Solid carbide twist drill SCD611 (12xD), internal coolant supply

Configurable features

**Diameter:**

Diameter in increments of 0.01 mm freely selectable

**Shank form:**

Shank form: HB | HE

Specification:

SCD611-[diameter]-2-4-140[shank form]12-HP358

Dimensions of configurable series

d ₁ min.	d ₁ max.	d ₂ h6	l ₁	l ₂	l ₃	l ₄
3,00	3,70	6	92	54	48	36
3,71	4,70	6	102	64	58	36
4,71	6,00	6	116	78	70	36
6,01	8,00	8	146	108	94	36
8,01	10,00	10	162	120	110	40
10,01	12,00	12	204	156	142	45
12,01	14,00	14	230	182	166	45
14,01	16,00	16	260	208	192	48
16,01	18,00	18	285	234	216	48
18,01	20,00	20	310	258	240	50

Example:

SCD611-**0431**-2-4-140**HE**12-HP358

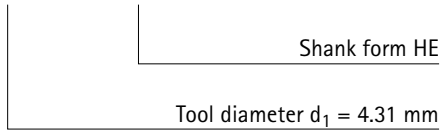

MICRO-Drill-Steel

Solid carbide twist drill
SCD371 (5xD), internal coolant supply

Design:

Drill diameter: 0.80 – 2.99 mm
Bore tolerance: IT9 (available)
Cutting material: HP246
Number of cutting edges: 2
Number of guiding chamfers: 4
Tip angle: 142°
Helix angle: 30°

Application:

Spotting drill specifically designed for the MEGA-Deep-Drill.
Maximum use up to < diameter 3.00 mm.

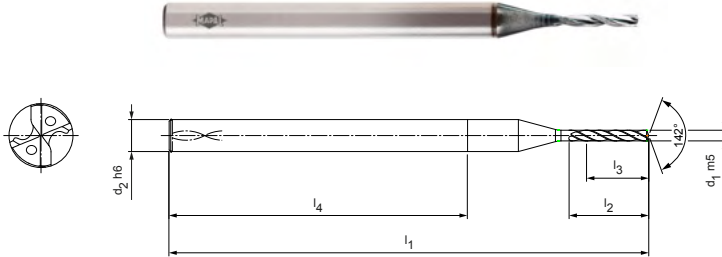

Stocked preferred series in shank form HA

Dimensions						Shank form HA	
d ₁ m5	d ₂ h6	l ₁	l ₂	l ₃	l ₄	Specification	Order no.
0,80	3	45	6	4	28	SCD371-0080-2-4-142HA05-HP246	31238823
1,00	3	45	7,5	5	28	SCD371-0100-2-4-142HA05-HP246	31238825
1,10	3	45	8,3	5	28	SCD371-0110-2-4-142HA05-HP246	31238826
1,20	3	45	9	6	28	SCD371-0120-2-4-142HA05-HP246	31238827
1,50	3	45	11,3	7,5	28	SCD371-0150-2-4-142HA05-HP246	31238890
1,60	3	50	12	8	28	SCD371-0160-2-4-142HA05-HP246	31238891
1,70	3	50	12,8	8	28	SCD371-0170-2-4-142HA05-HP246	31238892
1,80	3	50	13,5	8	28	SCD371-0180-2-4-142HA05-HP246	31238893
1,90	3	50	14,3	9,5	28	SCD371-0190-2-4-142HA05-HP246	31238894
2,00	3	50	15	10	28	SCD371-0200-2-4-142HA05-HP246	31238895
2,10	3	50	28	9,5	28	SCD371-0210-2-4-142HA05-HP246	31238896
2,20	3	52	16,5	11	28	SCD371-0220-2-4-142HA05-HP246	31238897
2,40	3	52	18	12	28	SCD371-0240-2-4-142HA05-HP246	31238899
2,50	3	52	18,8	12,5	28	SCD371-0250-2-4-142HA05-HP246	31238900
2,60	3	55	19,5	13	28	SCD371-0260-2-4-142HA05-HP246	31238901
2,70	3	55	20,3	13	28	SCD371-0270-2-4-142HA05-HP246	31238902
2,80	3	55	21	14	28	SCD371-0280-2-4-142HA05-HP246	31238903
2,90	3	55	21,8	13	28	SCD371-0290-2-4-142HA05-HP246	31238904

Configurable features



Diameter:
Diameter in increments of 0.01 mm freely selectable



Specification:

SCD371-[diameter]-2-4-142HA05-HP246

Example:

SCD371-0221-2-4-142HA05-HP246

Tool diameter d₁ = 2.21 mm

Dimensions of configurable series

d ₁ min.	d ₁ max.	d ₂ h6	l ₁	l ₂	l ₃	l ₄
0,80	0,99	3	45	6,0	4,0	28
1,00	1,29	3	45	7,5	5,0	28
1,30	1,59	3	45	9,8	6,5	28
1,60	1,89	3	50	12,0	8,0	28
1,90	2,19	3	50	14,3	9,5	28
2,20	2,59	3	52	16,5	11,0	28
2,60	2,99	3	55	19,5	13,0	28

Dimensions in mm.

For cutting data recommendations, see end of chapter.

Special designs and other coatings available upon request.

MICRO-Drill-Steel

Solid carbide twist drill
SCD371 (8xD), internal coolant supply

Design:
 Drill diameter: 1.00 – 2.99 mm
 Bore tolerance: IT9 (available)
 Cutting material: HP246
 Number of cutting edges: 2
 Number of guiding chamfers: 4
 Tip angle: 142°
 Helix angle: 30°

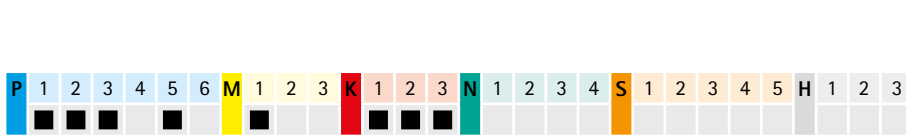
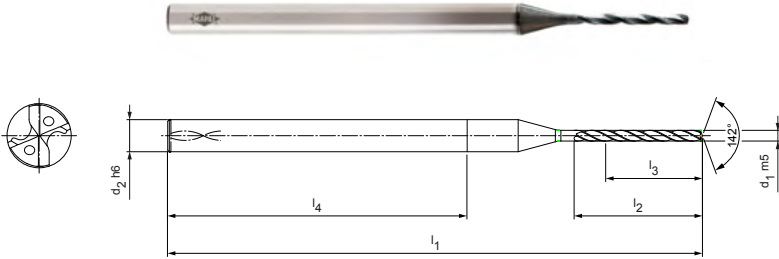

Stocked preferred series in shank form HA

Dimensions						Shank form HA	
d ₁ m5	d ₂ h6	l ₁	l ₂	l ₃	l ₄	Specification	Order no.
1,00	3	50	12	8	28	SCD371-0100-2-4-142HA08-HP246	31238905
1,20	3	50	14,4	9,6	28	SCD371-0120-2-4-142HA08-HP246	31238907
1,50	3	52	18	12	28	SCD371-0150-2-4-142HA08-HP246	31238910
1,60	3	55	19,2	12,8	28	SCD371-0160-2-4-142HA08-HP246	31238911
1,80	3	55	21,6	12,8	28	SCD371-0180-2-4-142HA08-HP246	31238913
1,90	3	60	22,8	15,2	28	SCD371-0190-2-4-142HA08-HP246	31238914
2,00	3	60	24	16	28	SCD371-0200-2-4-142HA08-HP246	31238915
2,10	3	60	25,2	15,2	28	SCD371-0210-2-4-142HA08-HP246	31238916
2,20	3	62	26,4	17,6	28	SCD371-0220-2-4-142HA08-HP246	31238917
2,50	3	62	30	20	28	SCD371-0250-2-4-142HA08-HP246	31238920
2,80	3	66	33,6	20,8	28	SCD371-0280-2-4-142HA08-HP246	31238923
2,90	3	66	34,8	20,8	28,0	SCD371-0290-2-4-142HA08-HP246	31238924

Configurable features



Diameter:
Diameter in increments of 0.01 mm freely selectable

Specification:
SCD371-[diameter]-2-4-142HA08-HP246

Dimensions of configurable series

d ₁ min.	d ₁ max.	d ₂ h6	l ₁	l ₂	l ₃	l ₄
1,00	1,29	3	50	12,0	8,0	28
1,30	1,59	3	52	15,6	10,4	28
1,60	1,89	3	55	19,2	12,8	28
1,90	2,19	3	60	22,8	15,2	28
2,20	2,59	3	62	26,4	17,6	28
2,60	2,99	3	66	31,2	20,8	28

Example:

SCD371-0221-2-4-142HA08-HP246

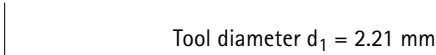

Dimensions in mm.
 For cutting data recommendations, see end of chapter.
 Special designs and other coatings available upon request.

MICRO-Drill-Steel

Solid carbide twist drill
SCD371 (12xD), internal coolant supply

Design:

Drill diameter: 1.00 – 2.99 mm
Bore tolerance: IT9 (available)
Cutting material: HP246
Number of cutting edges: 2
Number of guiding chamfers: 4
Tip angle: 142°
Helix angle: 30°

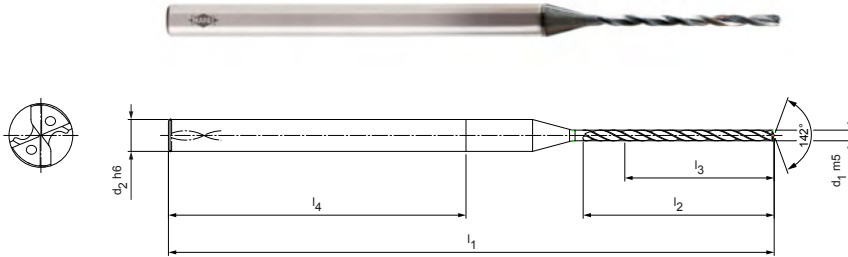

Stocked preferred series in shank form HA

Dimensions						Shank form HA	
d ₁ m5	d ₂ h6	l ₁	l ₂	l ₃	l ₄	Specification	Order no.
1,00	3	57	18	12	28	SCD371-0100-2-4-142HA12-HP246	31238925
1,20	3	57	21,6	14,4	28	SCD371-0120-2-4-142HA12-HP246	31238927
1,30	3	62	23,4	15,6	28	SCD371-0130-2-4-142HA12-HP246	31238928
1,50	3	62	27	18	28	SCD371-0150-2-4-142HA12-HP246	31238930
2,00	3	72	36	24	28	SCD371-0200-2-4-142HA12-HP246	31238935
2,10	3	72	37,8	22,8	28	SCD371-0210-2-4-142HA12-HP246	31238936
2,50	3	79	45	30	28	SCD371-0250-2-4-142HA12-HP246	31238940
2,80	3	85	50,4	31,2	28	SCD371-0280-2-4-142HA12-HP246	31238943
2,90	3	85	52,2	31,2	28	SCD371-0290-2-4-142HA12-HP246	31238944

Configurable features



Diameter:
Diameter in increments of
0.01 mm freely selectable



Specification:

SCD371-[diameter]-2-4-142HA12-HP246

Example:

SCD371-0221-2-4-142HA12-HP246

Tool diameter d₁ = 2.21 mm

Dimensions of configurable series

d ₁ min.	d ₁ max.	d ₂ h6	l ₁	l ₂	l ₃	l ₄
1,00	1,29	3	57	18,0	12,0	28
1,30	1,59	3	62	23,4	15,6	28
1,60	1,89	3	66	28,8	19,2	28
1,90	2,19	3	72	34,2	22,8	28
2,20	2,59	3	79	39,6	26,4	28
2,60	2,99	3	85	46,8	31,2	28

Dimensions in mm.

For cutting data recommendations, see end of chapter.

Special designs and other coatings available upon request.

MEGA-Drill-Hardened

Solid carbide twist drill
SCD140 (3xD)

Design:

Drill diameter: 2.55 – 20.00 mm
Bore tolerance: IT 9 (achievable)
Cutting material: HP809
Number of cutting edges: 2
Number of guiding chamfers: 2
Tip angle: 140°
Helix angle: 15°

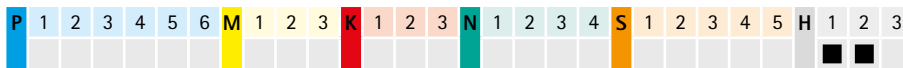
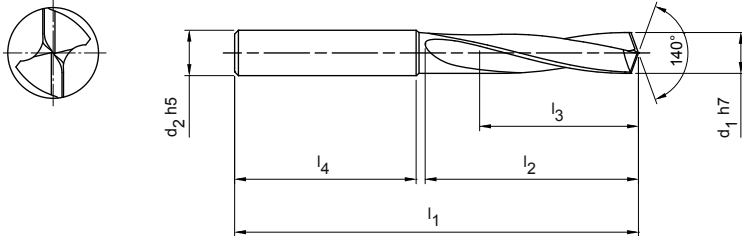

Stocked preferred series in shank form HA

Dimensions						Shank form HA	
d ₁ h7	d ₂ h5	l ₁	l ₂	l ₃	l ₄	Specification	Order no.
2,55	6	62	20	14	36	SCD140-0255-2-2-140HA03-HP809	31198190
2,60	6	62	20	14	36	SCD140-0260-2-2-140HA03-HP809	31198191
2,70	6	62	20	14	36	SCD140-0270-2-2-140HA03-HP809	31198192
2,80	6	62	20	14	36	SCD140-0280-2-2-140HA03-HP809	31198194
2,90	6	62	20	14	36	SCD140-0290-2-2-140HA03-HP809	31198196
3,00	6	62	20	14	36	SCD140-0300-2-2-140HA03-HP809	31151191
3,10	6	62	20	14	36	SCD140-0310-2-2-140HA03-HP809	31151192
3,20	6	62	20	14	36	SCD140-0320-2-2-140HA03-HP809	31151193
3,30	6	62	20	14	36	SCD140-0330-2-2-140HA03-HP809	31151194
3,40	6	62	20	14	36	SCD140-0340-2-2-140HA03-HP809	31151195
3,50	6	62	20	14	36	SCD140-0350-2-2-140HA03-HP809	31151196
3,60	6	62	20	14	36	SCD140-0360-2-2-140HA03-HP809	31151197
3,70	6	62	20	14	36	SCD140-0370-2-2-140HA03-HP809	31151198
3,80	6	66	24	17	36	SCD140-0380-2-2-140HA03-HP809	31151199
3,90	6	66	24	17	36	SCD140-0390-2-2-140HA03-HP809	31151330
4,00	6	66	24	17	36	SCD140-0400-2-2-140HA03-HP809	31151331
4,10	6	66	24	17	36	SCD140-0410-2-2-140HA03-HP809	31151332
4,20	6	66	24	17	36	SCD140-0420-2-2-140HA03-HP809	31151333
4,30	6	66	24	17	36	SCD140-0430-2-2-140HA03-HP809	31151334
4,40	6	66	24	17	36	SCD140-0440-2-2-140HA03-HP809	31151335
4,50	6	66	24	17	36	SCD140-0450-2-2-140HA03-HP809	31151336
4,60	6	66	24	17	36	SCD140-0460-2-2-140HA03-HP809	31151337
4,70	6	66	24	17	36	SCD140-0470-2-2-140HA03-HP809	31151339
4,80	6	66	28	20	36	SCD140-0480-2-2-140HA03-HP809	31151340
4,90	6	66	28	20	36	SCD140-0490-2-2-140HA03-HP809	31151341
5,00	6	66	28	20	36	SCD140-0500-2-2-140HA03-HP809	31151342
5,10	6	66	28	20	36	SCD140-0510-2-2-140HA03-HP809	31151343
5,20	6	66	28	20	36	SCD140-0520-2-2-140HA03-HP809	31151344
5,30	6	66	28	20	36	SCD140-0530-2-2-140HA03-HP809	31151345
5,40	6	66	28	20	36	SCD140-0540-2-2-140HA03-HP809	31151346
5,50	6	66	28	20	36	SCD140-0550-2-2-140HA03-HP809	31151347
5,55	6	66	28	20	36	SCD140-0555-2-2-140HA03-HP809	31151348
5,60	6	66	28	20	36	SCD140-0560-2-2-140HA03-HP809	31151349
5,70	6	66	28	20	36	SCD140-0570-2-2-140HA03-HP809	31151350
5,80	6	66	28	20	36	SCD140-0580-2-2-140HA03-HP809	31151351

MEGA-Drill-Hardened | Solid carbide twist drill SCD140 (3xD)

Dimensions						Shank form HA	
d ₁ h7	d ₂ h5	l ₁	l ₂	l ₃	l ₄	Specification	Order no.
5,90	6	66	28	20	36	SCD140-0590-2-2-140HA03-HP809	31151352
6,00	6	66	28	20	36	SCD140-0600-2-2-140HA03-HP809	31151353
6,10	8	79	34	24	36	SCD140-0610-2-2-140HA03-HP809	31151354
6,20	8	79	34	24	36	SCD140-0620-2-2-140HA03-HP809	31151355
6,30	8	79	34	24	36	SCD140-0630-2-2-140HA03-HP809	31151356
6,40	8	79	34	24	36	SCD140-0640-2-2-140HA03-HP809	31151357
6,50	8	79	34	24	36	SCD140-0650-2-2-140HA03-HP809	31151358
6,60	8	79	34	24	36	SCD140-0660-2-2-140HA03-HP809	31151359
6,70	8	79	34	24	36	SCD140-0670-2-2-140HA03-HP809	31151360
6,80	8	79	34	24	36	SCD140-0680-2-2-140HA03-HP809	31151361
6,90	8	79	34	24	36	SCD140-0690-2-2-140HA03-HP809	31151362
7,00	8	79	34	24	36	SCD140-0700-2-2-140HA03-HP809	31151363
7,10	8	79	41	29	36	SCD140-0710-2-2-140HA03-HP809	31151364
7,30	8	79	41	29	36	SCD140-0730-2-2-140HA03-HP809	31151366
7,40	8	79	41	29	36	SCD140-0740-2-2-140HA03-HP809	31151367
7,50	8	79	41	29	36	SCD140-0750-2-2-140HA03-HP809	31151368
7,80	8	79	41	29	36	SCD140-0780-2-2-140HA03-HP809	31151371
7,90	8	79	41	29	36	SCD140-0790-2-2-140HA03-HP809	31151372
8,00	8	79	41	29	36	SCD140-0800-2-2-140HA03-HP809	31151373
8,10	10	89	47	35	40	SCD140-0810-2-2-140HA03-HP809	31151374
8,20	10	89	47	35	40	SCD140-0820-2-2-140HA03-HP809	31151375
8,50	10	89	47	35	40	SCD140-0850-2-2-140HA03-HP809	31151378
8,60	10	89	47	35	40	SCD140-0860-2-2-140HA03-HP809	31151379
8,80	10	89	47	35	40	SCD140-0880-2-2-140HA03-HP809	31151381
9,00	10	89	47	35	40	SCD140-0900-2-2-140HA03-HP809	31151383
9,30	10	89	47	35	40	SCD140-0930-2-2-140HA03-HP809	31151386
9,50	10	89	47	35	40	SCD140-0950-2-2-140HA03-HP809	31151388
9,60	10	89	47	35	40	SCD140-0960-2-2-140HA03-HP809	31151389
9,70	10	89	47	35	40	SCD140-0970-2-2-140HA03-HP809	31151390
9,80	10	89	47	35	40	SCD140-0980-2-2-140HA03-HP809	31151391
10,00	10	89	47	35	40	SCD140-1000-2-2-140HA03-HP809	31151393
10,10	12	102	55	40	45	SCD140-1010-2-2-140HA03-HP809	31151394
10,20	12	102	55	40	45	SCD140-1020-2-2-140HA03-HP809	31151395
10,30	12	102	55	40	45	SCD140-1030-2-2-140HA03-HP809	31151396
10,40	12	102	55	40	45	SCD140-1040-2-2-140HA03-HP809	31151397
10,50	12	102	55	40	45	SCD140-1050-2-2-140HA03-HP809	31151398
11,00	12	102	55	40	45	SCD140-1100-2-2-140HA03-HP809	31151403
11,50	12	102	55	40	45	SCD140-1150-2-2-140HA03-HP809	31151408
11,80	12	102	55	40	45	SCD140-1180-2-2-140HA03-HP809	31151411
11,90	12	102	55	40	45	SCD140-1190-2-2-140HA03-HP809	31151412
12,00	12	102	55	40	45	SCD140-1200-2-2-140HA03-HP809	31151413
12,50	14	107	60	43	45	SCD140-1250-2-2-140HA03-HP809	31151415
12,80	14	107	60	43	45	SCD140-1280-2-2-140HA03-HP809	31151416
13,00	14	107	60	43	45	SCD140-1300-2-2-140HA03-HP809	31151417
13,50	14	107	60	43	45	SCD140-1350-2-2-140HA03-HP809	31151418
14,00	14	107	60	43	45	SCD140-1400-2-2-140HA03-HP809	31151420
14,20	16	115	65	45	48	SCD140-1420-2-2-140HA03-HP809	31151421
14,50	16	115	65	45	48	SCD140-1450-2-2-140HA03-HP809	31151422
14,80	16	115	65	45	48	SCD140-1480-2-2-140HA03-HP809	31151423
15,00	16	115	65	45	48	SCD140-1500-2-2-140HA03-HP809	31151424
15,50	16	115	65	45	48	SCD140-1550-2-2-140HA03-HP809	31151426
16,00	16	115	65	45	48	SCD140-1600-2-2-140HA03-HP809	31151428
17,50	18	123	73	51	48	SCD140-1750-2-2-140HA03-HP809	31151432

Continued on next page.

MEGA-Drill-Hardened | Solid carbide twist drill SCD140 (3xD)

Configurable features

**Diameter:**

Diameter in increments of 0.01 mm freely selectable

**Shank form:**

Shank form: HB | HE

Specification:

SCD140-[diameter]-2-2-140[shank form]03-HP809

Example:

SCD140-0431-2-2-140HE03-HP809

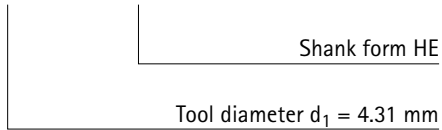

Dimensions of configurable series

d ₁ min.	d ₁ max.	d ₂ h6	l ₁	l ₂	l ₃	l ₄
2,55	3,79	6	62	20	14	36
3,80	4,79	6	66	24	17	36
4,80	6,00	6	66	28	20	36
6,01	7,00	8	79	34	24	36
7,01	8,00	8	79	41	29	36
8,01	10,00	10	89	47	35	40
10,01	12,00	12	102	55	40	45
12,01	14,00	14	107	60	43	45
14,01	16,00	16	115	65	45	48
16,01	18,00	18	123	73	51	48
18,01	20,00	20	131	79	55	50

Dimensions in mm.

For cutting data recommendations, see end of chapter.

Special designs and other coatings available upon request.

Tritan-Drill-Steel

Solid carbide twist drill
SCD661 (3xD), internal coolant supply

Design:
 Drill diameter: 4.00 – 20.00 mm
 Bore tolerance: \geq IT 9
 Cutting material: HP358
 Number of cutting edges: 3
 Number of guiding chamfers: 3
 Tip angle: 145°
 Helix angle: 30°

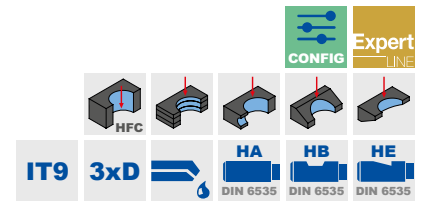
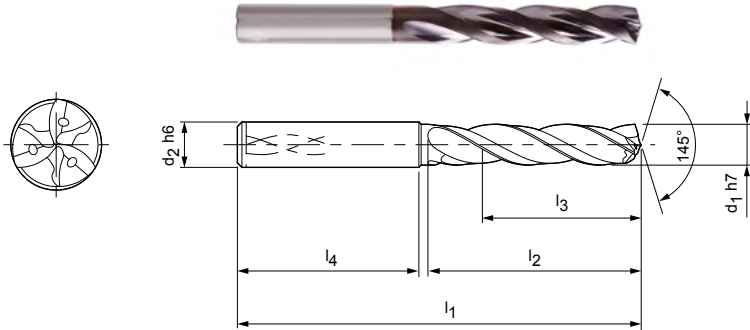

Stocked preferred series in shank form HA

Dimensions						Shank form HA	
d ₁ h7	d ₂ h6	l ₁	l ₂	l ₃	l ₄	Specification	Order no.
4,00	6	66	24	17	36	SCD661-0400-3-3-145HA03-HP358	30902036
4,10	6	66	24	17	36	SCD661-0410-3-3-145HA03-HP358	30902037
4,20	6	66	24	17	36	SCD661-0420-3-3-145HA03-HP358	30902038
4,30	6	66	24	17	36	SCD661-0430-3-3-145HA03-HP358	30902039
4,40	6	66	24	17	36	SCD661-0440-3-3-145HA03-HP358	30902040
4,50	6	66	24	17	36	SCD661-0450-3-3-145HA03-HP358	30902041
4,60	6	66	24	17	36	SCD661-0460-3-3-145HA03-HP358	30902042
4,65	6	66	24	17	36	SCD661-0465-3-3-145HA03-HP358	30902043
4,70	6	66	24	17	36	SCD661-0470-3-3-145HA03-HP358	30902044
4,80	6	66	28	20	36	SCD661-0480-3-3-145HA03-HP358	30902045
4,90	6	66	28	20	36	SCD661-0490-3-3-145HA03-HP358	30902046
5,00	6	66	28	20	36	SCD661-0500-3-3-145HA03-HP358	30902047
5,10	6	66	28	20	36	SCD661-0510-3-3-145HA03-HP358	30902048
5,20	6	66	28	20	36	SCD661-0520-3-3-145HA03-HP358	30902049
5,30	6	66	28	20	36	SCD661-0530-3-3-145HA03-HP358	30902050
5,40	6	66	28	20	36	SCD661-0540-3-3-145HA03-HP358	30902051
5,50	6	66	28	20	36	SCD661-0550-3-3-145HA03-HP358	30902052
5,55	6	66	28	20	36	SCD661-0555-3-3-145HA03-HP358	30902053
5,60	6	66	28	20	36	SCD661-0560-3-3-145HA03-HP358	30902054
5,70	6	66	28	20	36	SCD661-0570-3-3-145HA03-HP358	30902055
5,80	6	66	28	20	36	SCD661-0580-3-3-145HA03-HP358	30902056
5,90	6	66	28	20	36	SCD661-0590-3-3-145HA03-HP358	30902057
6,00	6	66	28	20	36	SCD661-0600-3-3-145HA03-HP358	30902058
6,10	8	79	34	24	36	SCD661-0610-3-3-145HA03-HP358	30902059
6,20	8	79	34	24	36	SCD661-0620-3-3-145HA03-HP358	30902060
6,30	8	79	34	24	36	SCD661-0630-3-3-145HA03-HP358	30902061
6,35	8	79	34	24	36	SCD661-0635-3-3-145HA03-HP358	31307522
6,40	8	79	34	24	36	SCD661-0640-3-3-145HA03-HP358	30902062
6,50	8	79	34	24	36	SCD661-0650-3-3-145HA03-HP358	30902063
6,60	8	79	34	24	36	SCD661-0660-3-3-145HA03-HP358	30902064
6,70	8	79	34	24	36	SCD661-0670-3-3-145HA03-HP358	30902065
6,80	8	79	34	24	36	SCD661-0680-3-3-145HA03-HP358	30902066
6,90	8	79	34	24	36	SCD661-0690-3-3-145HA03-HP358	30902067
7,00	8	79	34	24	36	SCD661-0700-3-3-145HA03-HP358	30902068
7,10	8	79	41	29	36	SCD661-0710-3-3-145HA03-HP358	30902069

Tritan-Drill-Steel | Solid carbide twist drill SCD661 (3xD), internal coolant supply

Dimensions						Shank form HA	
d ₁ h7	d ₂ h6	l ₁	l ₂	l ₃	l ₄	Specification	Order no.
7,20	8	79	41	29	36	SCD661-0720-3-3-145HA03-HP358	30902070
7,30	8	79	41	29	36	SCD661-0730-3-3-145HA03-HP358	30902071
7,40	8	79	41	29	36	SCD661-0740-3-3-145HA03-HP358	30902072
7,45	8	79	41	29	36	SCD661-0745-3-3-145HA03-HP358	30902073
7,50	8	79	41	29	36	SCD661-0750-3-3-145HA03-HP358	30902074
7,60	8	79	41	29	36	SCD661-0760-3-3-145HA03-HP358	30902075
7,70	8	79	41	29	36	SCD661-0770-3-3-145HA03-HP358	30902076
7,80	8	79	41	29	36	SCD661-0780-3-3-145HA03-HP358	30902077
7,90	8	79	41	29	36	SCD661-0790-3-3-145HA03-HP358	30902078
8,00	8	79	41	29	36	SCD661-0800-3-3-145HA03-HP358	30902079
8,10	10	89	47	35	40	SCD661-0810-3-3-145HA03-HP358	30902080
8,20	10	89	47	35	40	SCD661-0820-3-3-145HA03-HP358	30902081
8,30	10	89	47	35	40	SCD661-0830-3-3-145HA03-HP358	30902082
8,40	10	89	47	35	40	SCD661-0840-3-3-145HA03-HP358	30902083
8,50	10	89	47	35	40	SCD661-0850-3-3-145HA03-HP358	30902084
8,60	10	89	47	35	40	SCD661-0860-3-3-145HA03-HP358	30902085
8,70	10	89	47	35	40	SCD661-0870-3-3-145HA03-HP358	30902086
8,80	10	89	47	35	40	SCD661-0880-3-3-145HA03-HP358	30902087
9,00	10	89	47	35	40	SCD661-0900-3-3-145HA03-HP358	30902089
9,10	10	89	47	35	40	SCD661-0910-3-3-145HA03-HP358	30902090
9,20	10	89	47	35	40	SCD661-0920-3-3-145HA03-HP358	30902091
9,30	10	89	47	35	40	SCD661-0930-3-3-145HA03-HP358	30902092
9,35	10	89	47	35	40	SCD661-0935-3-3-145HA03-HP358	31307523
9,40	10	89	47	35	40	SCD661-0940-3-3-145HA03-HP358	30902093
9,50	10	89	47	35	40	SCD661-0950-3-3-145HA03-HP358	30902094
9,60	10	89	47	35	40	SCD661-0960-3-3-145HA03-HP358	30902095
9,70	10	89	47	35	40	SCD661-0970-3-3-145HA03-HP358	30902096
9,80	10	89	47	35	40	SCD661-0980-3-3-145HA03-HP358	30902097
9,90	10	89	47	35	40	SCD661-0990-3-3-145HA03-HP358	30902098
10,00	10	89	47	35	40	SCD661-1000-3-3-145HA03-HP358	30902099
10,10	12	102	55	40	45	SCD661-1010-3-3-145HA03-HP358	30902100
10,20	12	102	55	40	45	SCD661-1020-3-3-145HA03-HP358	30902101
10,30	12	102	55	40	45	SCD661-1030-3-3-145HA03-HP358	30902102
10,40	12	102	55	40	45	SCD661-1040-3-3-145HA03-HP358	30902103
10,50	12	102	55	40	45	SCD661-1050-3-3-145HA03-HP358	30902104
10,80	12	102	55	40	45	SCD661-1080-3-3-145HA03-HP358	30902107
10,90	12	102	55	40	45	SCD661-1090-3-3-145HA03-HP358	30902108
11,00	12	102	55	40	45	SCD661-1100-3-3-145HA03-HP358	30902109
11,10	12	102	55	40	45	SCD661-1110-3-3-145HA03-HP358	30902110
11,20	12	102	55	40	45	SCD661-1120-3-3-145HA03-HP358	30902111
11,30	12	102	55	40	45	SCD661-1130-3-3-145HA03-HP358	30902112
11,40	12	102	55	40	45	SCD661-1140-3-3-145HA03-HP358	30902113
11,50	12	102	55	40	45	SCD661-1150-3-3-145HA03-HP358	30902114
11,60	12	102	55	40	45	SCD661-1160-3-3-145HA03-HP358	30902115
11,70	12	102	55	40	45	SCD661-1170-3-3-145HA03-HP358	30902116
11,80	12	102	55	40	45	SCD661-1180-3-3-145HA03-HP358	30902117
11,90	12	102	55	40	45	SCD661-1190-3-3-145HA03-HP358	30902118
12,00	12	102	55	40	45	SCD661-1200-3-3-145HA03-HP358	30902119
12,20	14	107	60	43	45	SCD661-1220-3-3-145HA03-HP358	30902120
12,23	14	107	60	43	45	SCD661-1223-3-3-145HA03-HP358	31271441
12,50	14	107	60	43	45	SCD661-1250-3-3-145HA03-HP358	30902121
12,70	14	107	60	43	45	SCD661-1270-3-3-145HA03-HP358	31307524
13,00	14	107	60	43	45	SCD661-1300-3-3-145HA03-HP358	30902123
13,50	14	107	60	43	45	SCD661-1350-3-3-145HA03-HP358	30902125
13,80	14	107	60	43	45	SCD661-1380-3-3-145HA03-HP358	30902126
14,00	14	107	60	43	45	SCD661-1400-3-3-145HA03-HP358	30902127
14,20	16	115	65	45	48	SCD661-1420-3-3-145HA03-HP358	30902128

Tritan-Drill-Steel | Solid carbide twist drill SCD661 (3xD), internal coolant supply

Dimensions						Shank form HA	
d ₁ h7	d ₂ h6	l ₁	l ₂	l ₃	l ₄	Specification	Order no.
14,50	16	115	65	45	48	SCD661-1450-3-3-145HA03-HP358	30902129
14,80	16	115	65	45	48	SCD661-1480-3-3-145HA03-HP358	30902130
15,00	16	115	65	45	48	SCD661-1500-3-3-145HA03-HP358	30902131
15,20	16	115	65	45	48	SCD661-1520-3-3-145HA03-HP358	30902132
15,50	16	115	65	45	48	SCD661-1550-3-3-145HA03-HP358	30902133
15,80	16	115	65	45	48	SCD661-1580-3-3-145HA03-HP358	30902134
16,00	16	115	65	45	48	SCD661-1600-3-3-145HA03-HP358	30902135
16,20	18	123	73	51	48	SCD661-1620-3-3-145HA03-HP358	30902136
16,50	18	123	73	51	48	SCD661-1650-3-3-145HA03-HP358	30902137
17,00	18	123	73	51	48	SCD661-1700-3-3-145HA03-HP358	30902139
17,35	18	123	73	51	48	SCD661-1735-3-3-145HA03-HP358	31307525
17,50	18	123	73	51	48	SCD661-1750-3-3-145HA03-HP358	30902141
17,80	18	123	73	51	48	SCD661-1780-3-3-145HA03-HP358	30902142
18,00	18	123	73	51	48	SCD661-1800-3-3-145HA03-HP358	30902143
18,50	20	131	79	55	50	SCD661-1850-3-3-145HA03-HP358	30902145
18,80	20	131	79	55	50	SCD661-1880-3-3-145HA03-HP358	30902146
19,00	20	131	79	55	50	SCD661-1900-3-3-145HA03-HP358	30902147
19,50	20	131	79	55	50	SCD661-1950-3-3-145HA03-HP358	30902149
20,00	20	131	79	55	50	SCD661-2000-3-3-145HA03-HP358	30902151

Configurable features



Diameter:
Diameter in increments of
0.01 mm freely selectable



Shank form:
Shank form: HB | HE

Specification:

SCD661-[diameter]-3-3-140[shank form]03-HP358

Dimensions of configurable series

d ₁ min.	d ₁ max.	d ₂ h6	l ₁	l ₂	l ₃	l ₄
4,00	4,70	6	66	24	17	36
4,71	6,00	6	66	28	20	36
6,01	7,00	8	79	34	24	36
7,01	8,00	8	79	41	29	36
8,01	10,00	10	89	47	35	40
10,01	12,00	12	102	55	40	45
12,01	14,00	14	107	60	43	45
14,01	16,00	16	115	65	45	48
16,01	18,00	18	123	73	51	48
18,01	20,00	20	131	79	55	50

Example:

SCD661-0431-3-3-140HE03-HP358

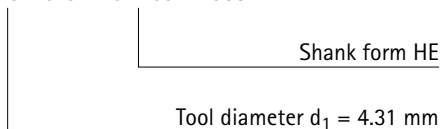

Dimensions in mm.

For cutting data recommendations, see end of chapter.

Special designs and other coatings available upon request.

Tritan-Drill-Steel

Solid carbide twist drill
SCD661 (5xD), internal coolant supply

Design:
 Drill diameter: 4.00 – 20.00 mm
 Bore tolerance: $\geq IT 9$
 Cutting material: HP358
 Number of cutting edges: 3
 Number of guiding chamfers: 3
 Tip angle: 145°
 Helix angle: 30°

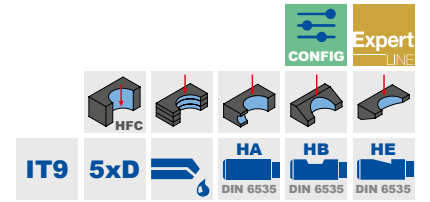
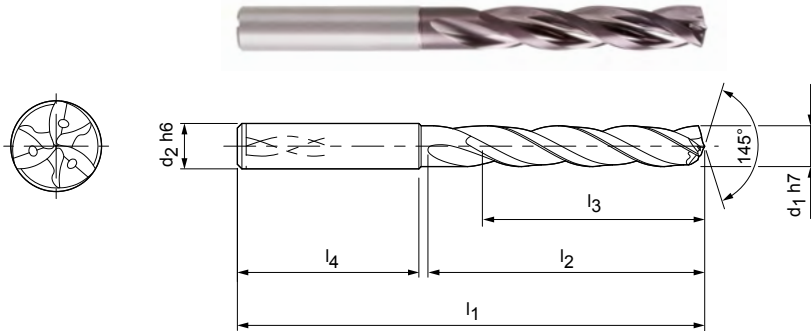

Stocked preferred series in shank form HA

Dimensions						Shank form HA	
d ₁ h7	d ₂ h6	l ₁	l ₂	l ₃	l ₄	Specification	Order no.
4,00	6	74	36	29	36	SCD661-0400-3-3-145HA05-HP358	30902152
4,10	6	74	36	29	36	SCD661-0410-3-3-145HA05-HP358	30902153
4,20	6	74	36	29	36	SCD661-0420-3-3-145HA05-HP358	30902154
4,30	6	74	36	29	36	SCD661-0430-3-3-145HA05-HP358	30902155
4,40	6	74	36	29	36	SCD661-0440-3-3-145HA05-HP358	30902156
4,50	6	74	36	29	36	SCD661-0450-3-3-145HA05-HP358	30902157
4,60	6	74	36	29	36	SCD661-0460-3-3-145HA05-HP358	30902158
4,65	6	74	36	29	36	SCD661-0465-3-3-145HA05-HP358	30902159
4,70	6	74	36	29	36	SCD661-0470-3-3-145HA05-HP358	30902160
4,80	6	82	44	35	36	SCD661-0480-3-3-145HA05-HP358	30902161
4,90	6	82	44	35	36	SCD661-0490-3-3-145HA05-HP358	30902162
5,00	6	82	44	35	36	SCD661-0500-3-3-145HA05-HP358	30902163
5,10	6	82	44	35	36	SCD661-0510-3-3-145HA05-HP358	30902164
5,20	6	82	44	35	36	SCD661-0520-3-3-145HA05-HP358	30902165
5,30	6	82	44	35	36	SCD661-0530-3-3-145HA05-HP358	30902166
5,40	6	82	44	35	36	SCD661-0540-3-3-145HA05-HP358	30902167
5,50	6	82	44	35	36	SCD661-0550-3-3-145HA05-HP358	30902168
5,55	6	82	44	35	36	SCD661-0555-3-3-145HA05-HP358	30902169
5,60	6	82	44	35	36	SCD661-0560-3-3-145HA05-HP358	30902170
5,70	6	82	44	35	36	SCD661-0570-3-3-145HA05-HP358	30902171
5,80	6	82	44	35	36	SCD661-0580-3-3-145HA05-HP358	30902172
5,90	6	82	44	35	36	SCD661-0590-3-3-145HA05-HP358	30902173
6,00	6	82	44	35	36	SCD661-0600-3-3-145HA05-HP358	30902174
6,05	8	91	53	43	36	SCD661-0605-3-3-145HA05-HP358	31307526
6,10	8	91	53	43	36	SCD661-0610-3-3-145HA05-HP358	30902175
6,20	8	91	53	43	36	SCD661-0620-3-3-145HA05-HP358	30902176
6,30	8	91	53	43	36	SCD661-0630-3-3-145HA05-HP358	30902177
6,40	8	91	53	43	36	SCD661-0640-3-3-145HA05-HP358	30902178
6,50	8	91	53	43	36	SCD661-0650-3-3-145HA05-HP358	30902179
6,60	8	91	53	43	36	SCD661-0660-3-3-145HA05-HP358	30902180
6,80	8	91	53	43	36	SCD661-0680-3-3-145HA05-HP358	30902182
6,90	8	91	53	43	36	SCD661-0690-3-3-145HA05-HP358	30902183
7,00	8	91	53	43	36	SCD661-0700-3-3-145HA05-HP358	30902184
7,10	8	91	53	43	36	SCD661-0710-3-3-145HA05-HP358	30902185
7,20	8	91	53	43	36	SCD661-0720-3-3-145HA05-HP358	30902186

Tritan-Drill-Steel | Solid carbide twist drill SCD661 (5xD), internal coolant supply

Dimensions						Shank form HA	
d ₁ h7	d ₂ h6	l ₁	l ₂	l ₃	l ₄	Specification	Order no.
7,30	8	91	53	43	36	SCD661-0730-3-3-145HA05-HP358	30902187
7,40	8	91	53	43	36	SCD661-0740-3-3-145HA05-HP358	30902188
7,45	8	91	53	43	36	SCD661-0745-3-3-145HA05-HP358	30902189
7,50	8	91	53	43	36	SCD661-0750-3-3-145HA05-HP358	30902190
7,60	8	91	53	43	36	SCD661-0760-3-3-145HA05-HP358	30902191
7,70	8	91	53	43	36	SCD661-0770-3-3-145HA05-HP358	30902192
7,80	8	91	53	43	36	SCD661-0780-3-3-145HA05-HP358	30902193
7,90	8	91	53	43	36	SCD661-0790-3-3-145HA05-HP358	30902194
8,00	8	91	53	43	36	SCD661-0800-3-3-145HA05-HP358	30902195
8,10	10	103	61	49	40	SCD661-0810-3-3-145HA05-HP358	30902196
8,20	10	103	61	49	40	SCD661-0820-3-3-145HA05-HP358	30902197
8,30	10	103	61	49	40	SCD661-0830-3-3-145HA05-HP358	30902198
8,40	10	103	61	49	40	SCD661-0840-3-3-145HA05-HP358	30902199
8,50	10	103	61	49	40	SCD661-0850-3-3-145HA05-HP358	30902200
8,60	10	103	61	49	40	SCD661-0860-3-3-145HA05-HP358	30902201
8,70	10	103	61	49	40	SCD661-0870-3-3-145HA05-HP358	30902202
8,80	10	103	61	49	40	SCD661-0880-3-3-145HA05-HP358	30902203
8,90	10	103	61	49	40	SCD661-0890-3-3-145HA05-HP358	30902204
9,00	10	103	61	49	40	SCD661-0900-3-3-145HA05-HP358	30902205
9,10	10	103	61	49	40	SCD661-0910-3-3-145HA05-HP358	30902206
9,20	10	103	61	49	40	SCD661-0920-3-3-145HA05-HP358	30902207
9,30	10	103	61	49	40	SCD661-0930-3-3-145HA05-HP358	30902208
9,35	10	103	61	49	40	SCD661-0935-3-3-145HA05-HP358	30902209
9,40	10	103	61	49	40	SCD661-0940-3-3-145HA05-HP358	30902210
9,50	10	103	61	49	40	SCD661-0950-3-3-145HA05-HP358	30902211
9,70	10	103	61	49	40	SCD661-0970-3-3-145HA05-HP358	30902214
9,80	10	103	61	49	40	SCD661-0980-3-3-145HA05-HP358	30902215
9,90	10	103	61	49	40	SCD661-0990-3-3-145HA05-HP358	30902216
10,00	10	103	61	49	40	SCD661-1000-3-3-145HA05-HP358	30902217
10,10	12	118	71	56	45	SCD661-1010-3-3-145HA05-HP358	30902218
10,20	12	118	71	56	45	SCD661-1020-3-3-145HA05-HP358	30902219
10,30	12	118	71	56	45	SCD661-1030-3-3-145HA05-HP358	30902220
10,40	12	118	71	56	45	SCD661-1040-3-3-145HA05-HP358	30902221
10,50	12	118	71	56	45	SCD661-1050-3-3-145HA05-HP358	30902222
10,80	12	118	71	56	45	SCD661-1080-3-3-145HA05-HP358	30902225
11,00	12	118	71	56	45	SCD661-1100-3-3-145HA05-HP358	30902227
11,10	12	118	71	56	45	SCD661-1110-3-3-145HA05-HP358	30902228
11,20	12	118	71	56	45	SCD661-1120-3-3-145HA05-HP358	30902229
11,30	12	118	71	56	45	SCD661-1130-3-3-145HA05-HP358	30902230
11,40	12	118	71	56	45	SCD661-1140-3-3-145HA05-HP358	30902231
11,50	12	118	71	56	45	SCD661-1150-3-3-145HA05-HP358	30902232
11,80	12	118	71	56	45	SCD661-1180-3-3-145HA05-HP358	30902235
11,90	12	118	71	56	45	SCD661-1190-3-3-145HA05-HP358	30902236
12,00	12	118	71	56	45	SCD661-1200-3-3-145HA05-HP358	30902237
12,20	14	124	77	60	45	SCD661-1220-3-3-145HA05-HP358	30902238
12,50	14	124	77	60	45	SCD661-1250-3-3-145HA05-HP358	30902239
12,80	14	124	77	60	45	SCD661-1280-3-3-145HA05-HP358	30902240
13,00	14	124	77	60	45	SCD661-1300-3-3-145HA05-HP358	30902241
13,50	14	124	77	60	45	SCD661-1350-3-3-145HA05-HP358	30902243
13,80	14	124	77	60	45	SCD661-1380-3-3-145HA05-HP358	30902244
14,00	14	124	77	60	45	SCD661-1400-3-3-145HA05-HP358	30902245
14,20	16	133	83	63	48	SCD661-1420-3-3-145HA05-HP358	30902246
14,50	16	133	83	63	48	SCD661-1450-3-3-145HA05-HP358	30902247
14,80	16	133	83	63	48	SCD661-1480-3-3-145HA05-HP358	30902248
15,00	16	133	83	63	48	SCD661-1500-3-3-145HA05-HP358	30902249
15,10	16	133	83	63	48	SCD661-1510-3-3-145HA05-HP358	30902250
15,20	16	133	83	63	48	SCD661-1520-3-3-145HA05-HP358	30902251

Continued on next page.

Tritan-Drill-Steel | Solid carbide twist drill SCD661 (5xD), internal coolant supply

Dimensions						Shank form HA	
d ₁ h7	d ₂ h6	l ₁	l ₂	l ₃	l ₄	Specification	Order no.
15,25	16	133	83	63	48	SCD661-1525-3-3-145HA05-HP358	30902252
15,50	16	133	83	63	48	SCD661-1550-3-3-145HA05-HP358	30902253
15,80	16	133	83	63	48	SCD661-1580-3-3-145HA05-HP358	30902254
16,00	16	133	83	63	48	SCD661-1600-3-3-145HA05-HP358	30902255
16,20	18	143	93	71	48	SCD661-1620-3-3-145HA05-HP358	30902256
16,50	18	143	93	71	48	SCD661-1650-3-3-145HA05-HP358	30902257
16,80	18	143	93	71	48	SCD661-1680-3-3-145HA05-HP358	30902258
17,00	18	143	93	71	48	SCD661-1700-3-3-145HA05-HP358	30902259
17,50	18	143	93	71	48	SCD661-1750-3-3-145HA05-HP358	30902261
18,00	18	143	93	71	48	SCD661-1800-3-3-145HA05-HP358	30902263
18,50	20	153	101	77	50	SCD661-1850-3-3-145HA05-HP358	30902265
18,80	20	153	101	77	50	SCD661-1880-3-3-145HA05-HP358	30902266
19,00	20	153	101	77	50	SCD661-1900-3-3-145HA05-HP358	30902267
19,50	20	153	101	77	50	SCD661-1950-3-3-145HA05-HP358	30902269
19,80	20	153	101	77	50	SCD661-1980-3-3-145HA05-HP358	30902270
20,00	20	153	101	77	50	SCD661-2000-3-3-145HA05-HP358	30902271

Configurable features



Diameter:
Diameter in increments of
0.01 mm freely selectable



Shank form:
Shank form: HB | HE

Specification:

SCD661-[diameter]-3-3-145[shank form]05-HP358

Dimensions of configurable series

d ₁ min.	d ₁ max.	d ₂ h6	l ₁	l ₂	l ₃	l ₄
4,00	4,70	6	74	36	29	36
4,71	6,00	6	82	44	35	36
6,01	8,00	8	91	53	43	36
8,01	10,00	10	103	61	49	40
10,01	12,00	12	118	71	56	45
12,01	14,00	14	124	77	60	45
14,01	16,00	16	133	83	63	48
16,01	18,00	18	143	93	71	48
18,01	20,00	20	153	101	77	50

Example:

SCD661-0431-3-3-145HE05-HP358

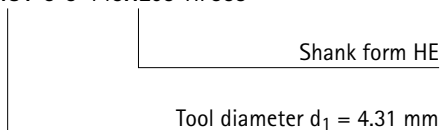

Dimensions in mm.

For cutting data recommendations, see end of chapter.

Special designs and other coatings available upon request.

Tritan-Drill-Steel

Solid carbide twist drill
SCD661 (8xD), internal coolant supply

Design:
 Drill diameter: 4.00 – 20.00 mm
 Bore tolerance: \geq IT 9
 Cutting material: HP358
 Number of cutting edges: 3
 Number of guiding chamfers: 3
 Tip angle: 140°
 Helix angle: 30°

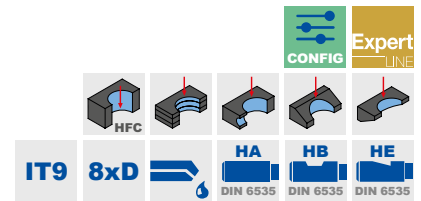
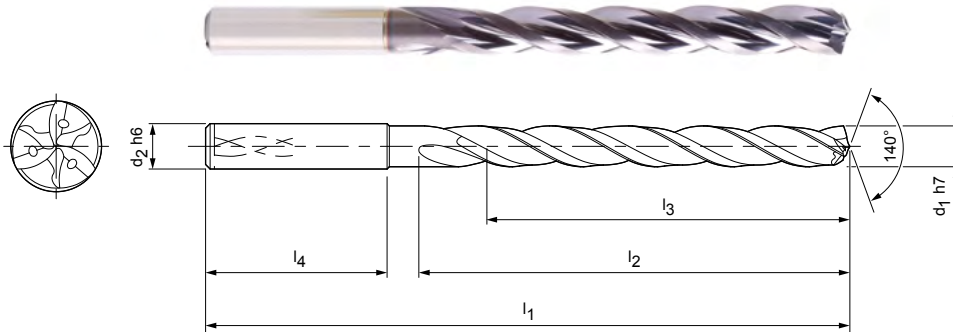

Stocked preferred series in shank form HA

Dimensions						Shank form HA	
d ₁ h7	d ₂ h6	l ₁	l ₂	l ₃	l ₄	Specification	Order no.
4,00	6	81	43	36	36	SCD661-0400-3-3-140HA08-HP358	30902272
4,10	6	81	43	36	36	SCD661-0410-3-3-140HA08-HP358	30902273
4,20	6	81	43	36	36	SCD661-0420-3-3-140HA08-HP358	30902274
4,30	6	81	43	36	36	SCD661-0430-3-3-140HA08-HP358	30902275
4,50	6	81	43	36	36	SCD661-0450-3-3-140HA08-HP358	30902277
4,60	6	81	43	36	36	SCD661-0460-3-3-140HA08-HP358	30902278
4,70	6	81	43	36	36	SCD661-0470-3-3-140HA08-HP358	30902279
4,80	6	95	57	48	36	SCD661-0480-3-3-140HA08-HP358	30902280
5,00	6	95	57	48	36	SCD661-0500-3-3-140HA08-HP358	30902282
5,10	6	95	57	48	36	SCD661-0510-3-3-140HA08-HP358	30902283
5,20	6	95	57	48	36	SCD661-0520-3-3-140HA08-HP358	30902284
5,40	6	95	57	48	36	SCD661-0540-3-3-140HA08-HP358	30902286
5,50	6	95	57	48	36	SCD661-0550-3-3-140HA08-HP358	30902287
5,60	6	95	57	48	36	SCD661-0560-3-3-140HA08-HP358	30902288
5,80	6	95	57	48	36	SCD661-0580-3-3-140HA08-HP358	30902290
5,90	6	95	57	48	36	SCD661-0590-3-3-140HA08-HP358	30902291
6,00	6	95	57	48	36	SCD661-0600-3-3-140HA08-HP358	30902292
6,10	8	114	76	64	36	SCD661-0610-3-3-140HA08-HP358	30902293
6,50	8	114	76	64	36	SCD661-0650-3-3-140HA08-HP358	30902297
6,60	8	114	76	64	36	SCD661-0660-3-3-140HA08-HP358	30902298
6,80	8	114	76	64	36	SCD661-0680-3-3-140HA08-HP358	30902300
6,90	8	114	76	64	36	SCD661-0690-3-3-140HA08-HP358	30902301
7,00	8	114	76	64	36	SCD661-0700-3-3-140HA08-HP358	30902302
7,50	8	114	76	64	36	SCD661-0750-3-3-140HA08-HP358	30902307
7,80	8	114	76	64	36	SCD661-0780-3-3-140HA08-HP358	30902310
7,90	8	114	76	64	36	SCD661-0790-3-3-140HA08-HP358	30902311
8,00	8	114	76	64	36	SCD661-0800-3-3-140HA08-HP358	30902312
8,10	10	142	95	80	40	SCD661-0810-3-3-140HA08-HP358	30902313
8,20	10	142	95	80	40	SCD661-0820-3-3-140HA08-HP358	30902314
8,50	10	142	95	80	40	SCD661-0850-3-3-140HA08-HP358	30902317
8,60	10	142	95	80	40	SCD661-0860-3-3-140HA08-HP358	30902318
8,80	10	142	95	80	40	SCD661-0880-3-3-140HA08-HP358	30902320
9,00	10	142	95	80	40	SCD661-0900-3-3-140HA08-HP358	30902322
9,10	10	142	95	80	40	SCD661-0910-3-3-140HA08-HP358	30902323
9,50	10	142	95	80	40	SCD661-0950-3-3-140HA08-HP358	30902327

Tritan-Drill-Steel | Solid carbide twist drill SCD661 (8xD), internal coolant supply

Dimensions						Shank form HA	
d ₁ h7	d ₂ h6	l ₁	l ₂	l ₃	l ₄	Specification	Order no.
9,80	10	142	95	80	40	SCD661-0980-3-3-140HA08-HP358	30902330
10,00	10	142	95	80	40	SCD661-1000-3-3-140HA08-HP358	30902332
10,20	12	162	114	96	45	SCD661-1020-3-3-140HA08-HP358	30902334
10,30	12	162	114	96	45	SCD661-1030-3-3-140HA08-HP358	30902335
10,50	12	162	114	96	45	SCD661-1050-3-3-140HA08-HP358	30902337
11,00	12	162	114	96	45	SCD661-1100-3-3-140HA08-HP358	30902342
11,50	12	162	114	96	45	SCD661-1150-3-3-140HA08-HP358	30902347
11,80	12	162	114	96	45	SCD661-1180-3-3-140HA08-HP358	30902350
11,90	12	162	114	96	45	SCD661-1190-3-3-140HA08-HP358	30902351
12,00	12	162	114	96	45	SCD661-1200-3-3-140HA08-HP358	30902352
12,20	14	178	133	112	45	SCD661-1220-3-3-140HA08-HP358	30902353
12,50	14	178	133	112	45	SCD661-1250-3-3-140HA08-HP358	30902354
13,00	14	178	133	112	45	SCD661-1300-3-3-140HA08-HP358	30902356
13,50	14	178	133	112	45	SCD661-1350-3-3-140HA08-HP358	30902358
13,80	14	178	133	112	45	SCD661-1380-3-3-140HA08-HP358	30902359
14,00	14	178	133	112	45	SCD661-1400-3-3-140HA08-HP358	30902360
14,20	16	203	152	128	48	SCD661-1420-3-3-140HA08-HP358	30902361
14,50	16	203	152	128	48	SCD661-1450-3-3-140HA08-HP358	30902362
15,00	16	203	152	128	48	SCD661-1500-3-3-140HA08-HP358	30902364
15,50	16	203	152	128	48	SCD661-1550-3-3-140HA08-HP358	30902366
15,80	16	203	152	128	48	SCD661-1580-3-3-140HA08-HP358	30902367
16,00	16	203	152	128	48	SCD661-1600-3-3-140HA08-HP358	30902368
17,00	18	222	171	144	48	SCD661-1700-3-3-140HA08-HP358	30902372
17,50	18	222	171	144	48	SCD661-1750-3-3-140HA08-HP358	30902374
18,00	18	222	171	144	48	SCD661-1800-3-3-140HA08-HP358	30902376
18,50	20	243	190	160	50	SCD661-1850-3-3-140HA08-HP358	30902378
19,00	20	243	190	160	50	SCD661-1900-3-3-140HA08-HP358	30902380
19,20	20	243	190	160	50	SCD661-1920-3-3-140HA08-HP358	30902381
19,50	20	243	190	160	50	SCD661-1950-3-3-140HA08-HP358	30902382
20,00	20	243	190	160	50	SCD661-2000-3-3-140HA08-HP358	30902384

Configurable features



Diameter:
Diameter in increments of 0.01 mm freely selectable



Shank form:
Shank form: HB | HE

Specification:
SCD661-[diameter]-3-3-140[shank form]08-HP358

Dimensions of configurable series

d ₁ min.	d ₁ max.	d ₂ h6	l ₁	l ₂	l ₃	l ₄
4,00	4,70	6	81	43	36	36
4,71	6,00	6	95	57	48	36
6,01	8,00	8	114	76	64	36
8,01	10,00	10	142	95	80	40
10,01	12,00	12	162	114	96	45
12,01	14,00	14	178	133	112	45
14,01	16,00	16	203	152	128	48
16,01	18,00	18	222	171	144	48
18,01	20,00	20	243	190	160	50

Example:

SCD661-0431-3-3-140HE08-HP358

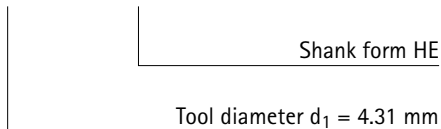

Dimensions in mm.

For cutting data recommendations, see end of chapter.

Special designs and other coatings available upon request.

Tritan-Drill-Steel

Solid carbide twist drill
SCD661 (12xD), internal coolant supply

Design:

Drill diameter: 4.00 – 20.00 mm
Bore tolerance: \geq IT 9
Cutting material: HP358
Number of cutting edges: 3
Number of guiding chamfers: 3
Tip angle: 140°
Helix angle: 30°

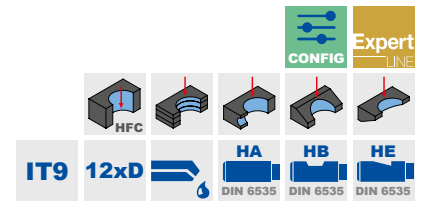
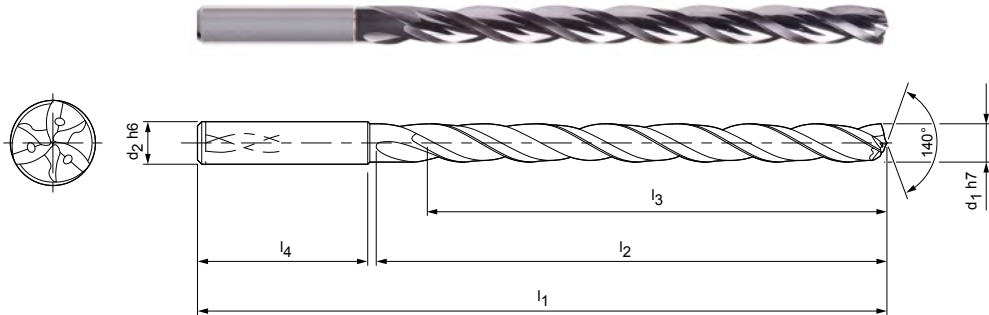

Stocked preferred series in shank form HA

Dimensions						Shank form HA	
d ₁ h7	d ₂ h6	l ₁	l ₂	l ₃	l ₄	Specification	Order no.
4,00	6	102	64	58	36	SCD661-0400-3-3-140HA12-HP358	30902385
4,10	6	102	64	58	36	SCD661-0410-3-3-140HA12-HP358	30902386
4,20	6	102	64	58	36	SCD661-0420-3-3-140HA12-HP358	30902387
4,30	6	102	64	58	36	SCD661-0430-3-3-140HA12-HP358	30902388
4,50	6	102	64	58	36	SCD661-0450-3-3-140HA12-HP358	30902390
4,60	6	102	64	58	36	SCD661-0460-3-3-140HA12-HP358	30902391
4,80	6	116	78	70	36	SCD661-0480-3-3-140HA12-HP358	30902393
5,00	6	116	78	70	36	SCD661-0500-3-3-140HA12-HP358	30902395
5,10	6	116	78	70	36	SCD661-0510-3-3-140HA12-HP358	30902396
5,20	6	116	78	70	36	SCD661-0520-3-3-140HA12-HP358	30902397
5,40	6	116	78	70	36	SCD661-0540-3-3-140HA12-HP358	30902399
5,50	6	116	78	70	36	SCD661-0550-3-3-140HA12-HP358	30902400
5,80	6	116	78	70	36	SCD661-0580-3-3-140HA12-HP358	30902403
5,90	6	116	78	70	36	SCD661-0590-3-3-140HA12-HP358	30902404
6,00	6	116	78	70	36	SCD661-0600-3-3-140HA12-HP358	30902405
6,10	8	146	108	94	36	SCD661-0610-3-3-140HA12-HP358	30902406
6,50	8	146	108	94	36	SCD661-0650-3-3-140HA12-HP358	30902410
6,80	8	146	108	94	36	SCD661-0680-3-3-140HA12-HP358	30902413
7,00	8	146	108	94	36	SCD661-0700-3-3-140HA12-HP358	30902415
7,50	8	146	108	94	36	SCD661-0750-3-3-140HA12-HP358	30902420
7,80	8	146	108	94	36	SCD661-0780-3-3-140HA12-HP358	30902423
7,90	8	146	108	94	36	SCD661-0790-3-3-140HA12-HP358	30902424
8,00	8	146	108	94	36	SCD661-0800-3-3-140HA12-HP358	30902425
8,20	10	162	120	110	40	SCD661-0820-3-3-140HA12-HP358	30902427
8,40	10	162	120	110	40	SCD661-0840-3-3-140HA12-HP358	30902429
8,50	10	162	120	110	40	SCD661-0850-3-3-140HA12-HP358	30902430
8,80	10	162	120	110	40	SCD661-0880-3-3-140HA12-HP358	30902433
9,00	10	162	120	110	40	SCD661-0900-3-3-140HA12-HP358	30902435
9,50	10	162	120	110	40	SCD661-0950-3-3-140HA12-HP358	30902440
9,60	10	162	120	110	40	SCD661-0960-3-3-140HA12-HP358	30902441
9,80	10	162	120	110	40	SCD661-0980-3-3-140HA12-HP358	30902443
10,00	10	162	120	110	40	SCD661-1000-3-3-140HA12-HP358	30902445
10,20	12	204	156	142	45	SCD661-1020-3-3-140HA12-HP358	30902447
10,30	12	204	156	142	45	SCD661-1030-3-3-140HA12-HP358	30902448
10,50	12	204	156	142	45	SCD661-1050-3-3-140HA12-HP358	30902450

Tritan-Drill-Steel | Solid carbide twist drill SCD661 (12xD), internal coolant supply

Dimensions						Shank form HA	
d ₁ h7	d ₂ h6	l ₁	l ₂	l ₃	l ₄	Specification	Order no.
11,00	12	204	156	142	45	SCD661-1100-3-3-140HA12-HP358	30902455
11,50	12	204	156	142	45	SCD661-1150-3-3-140HA12-HP358	30902460
11,80	12	204	156	142	45	SCD661-1180-3-3-140HA12-HP358	30902463
12,00	12	204	156	142	45	SCD661-1200-3-3-140HA12-HP358	30902465
12,50	14	230	182	166	45	SCD661-1250-3-3-140HA12-HP358	30902467
13,00	14	230	182	166	45	SCD661-1300-3-3-140HA12-HP358	30902469
13,50	14	230	182	166	45	SCD661-1350-3-3-140HA12-HP358	30902471
14,00	14	230	182	166	45	SCD661-1400-3-3-140HA12-HP358	30902473
14,50	16	260	208	192	48	SCD661-1450-3-3-140HA12-HP358	30902475
15,00	16	260	208	192	48	SCD661-1500-3-3-140HA12-HP358	30902477
15,50	16	260	208	192	48	SCD661-1550-3-3-140HA12-HP358	30902479
16,00	16	260	208	192	48	SCD661-1600-3-3-140HA12-HP358	30902481
16,50	18	285	234	216	48	SCD661-1650-3-3-140HA12-HP358	30902483
17,00	18	285	234	216	48	SCD661-1700-3-3-140HA12-HP358	30902485
17,50	18	285	234	216	48	SCD661-1750-3-3-140HA12-HP358	30902487
18,00	18	285	234	216	48	SCD661-1800-3-3-140HA12-HP358	30902489
18,50	20	310	258	240	50	SCD661-1850-3-3-140HA12-HP358	30902491
19,00	20	310	258	240	50	SCD661-1900-3-3-140HA12-HP358	30902493
19,50	20	310	258	240	50	SCD661-1950-3-3-140HA12-HP358	30902495
20,00	20	310	258	240	50	SCD661-2000-3-3-140HA12-HP358	30902497

Configurable features

**Diameter:**

Diameter in increments of 0.01 mm freely selectable

**Shank form:**

Shank form: HB | HE

Specification:

SCD661-[diameter]-3-3-140[shank form]12-HP358

Dimensions of configurable series

d ₁ min.	d ₁ max.	d ₂ h6	l ₁	l ₂	l ₃	l ₄
4,00	4,70	6	102	64	58	36
4,71	6,00	6	116	78	70	36
6,01	8,00	8	146	108	94	36
8,01	10,00	10	162	120	110	40
10,01	12,00	12	204	156	142	45
12,01	14,00	14	230	182	166	45
14,01	16,00	16	260	208	192	48
16,01	18,00	18	285	234	216	48
18,01	20,00	20	310	258	240	50

Example:

SCD661-0431-3-3-140HE12-HP358

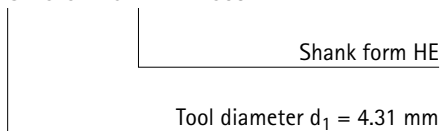

Dimensions in mm.

For cutting data recommendations, see end of chapter.

Special designs and other coatings available upon request.

MEGA-Speed-Drill-Steel

Solid carbide twist drill

SCD621 (3xD), internal coolant supply, follow-up product to the MEGA-Speed-Drill-Uni (SCD22)

Design:

Drill diameter: 3.00 – 20.00 mm
 Bore tolerance: IT 9 (achievable)
 Cutting material: HP358
 Number of cutting edges: 2
 Number of guiding chamfers: 3
 Tip angle: 145°
 Helix angle: 30°

Application:

For high-speed machining.

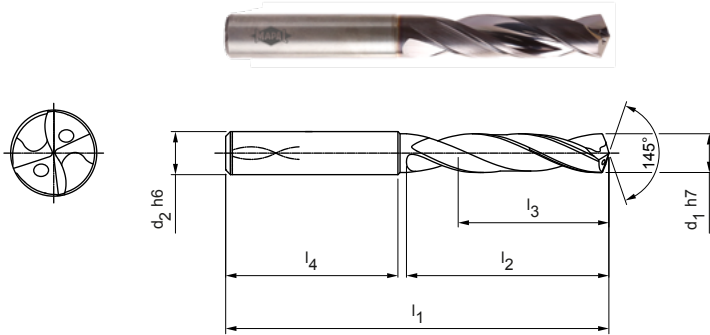

Stocked preferred series in shank form HA

Dimensions						Shank form HA	
d ₁ h7	d ₂ h6	l ₁	l ₂	l ₃	l ₄	Specification	Order no.
3,00	6	62	20	14	36	SCD621-0300-2-3-145HA03-HP358	31036265
3,20	6	62	20	14	36	SCD621-0320-2-3-145HA03-HP358	31036267
3,30	6	62	20	14	36	SCD621-0330-2-3-145HA03-HP358	31036268
3,40	6	62	20	14	36	SCD621-0340-2-3-145HA03-HP358	31036269
3,50	6	62	20	14	36	SCD621-0350-2-3-145HA03-HP358	31036270
3,70	6	62	20	14	36	SCD621-0370-2-3-145HA03-HP358	31036272
3,80	6	66	24	17	36	SCD621-0380-2-3-145HA03-HP358	31036273
3,90	6	66	24	17	36	SCD621-0390-2-3-145HA03-HP358	31036274
4,00	6	66	24	17	36	SCD621-0400-2-3-145HA03-HP358	31036275
4,10	6	66	24	17	36	SCD621-0410-2-3-145HA03-HP358	31036276
4,20	6	66	24	17	36	SCD621-0420-2-3-145HA03-HP358	31036277
4,30	6	66	24	17	36	SCD621-0430-2-3-145HA03-HP358	31036278
4,50	6	66	24	17	36	SCD621-0450-2-3-145HA03-HP358	31036280
4,60	6	66	24	17	36	SCD621-0460-2-3-145HA03-HP358	31036281
4,65	6	66	24	17	36	SCD621-0465-2-3-145HA03-HP358	31307528
4,70	6	66	24	17	36	SCD621-0470-2-3-145HA03-HP358	31036282
4,90	6	66	28	20	36	SCD621-0490-2-3-145HA03-HP358	31036284
5,00	6	66	28	20	36	SCD621-0500-2-3-145HA03-HP358	31036285
5,10	6	66	28	20	36	SCD621-0510-2-3-145HA03-HP358	31036286
5,20	6	66	28	20	36	SCD621-0520-2-3-145HA03-HP358	31036287
5,50	6	66	28	20	36	SCD621-0550-2-3-145HA03-HP358	31036290
5,60	6	66	28	20	36	SCD621-0560-2-3-145HA03-HP358	31036291
5,80	6	66	28	20	36	SCD621-0580-2-3-145HA03-HP358	31036293
5,90	6	66	28	20	36	SCD621-0590-2-3-145HA03-HP358	31036294
6,00	6	66	28	20	36	SCD621-0600-2-3-145HA03-HP358	31036295
6,10	8	79	34	24	36	SCD621-0610-2-3-145HA03-HP358	31036296
6,20	8	79	34	24	36	SCD621-0620-2-3-145HA03-HP358	31036297
6,30	8	79	34	24	36	SCD621-0630-2-3-145HA03-HP358	31036298
6,40	8	79	34	24	36	SCD621-0640-2-3-145HA03-HP358	31036299
6,50	8	79	34	24	36	SCD621-0650-2-3-145HA03-HP358	31036300
6,60	8	79	34	24	36	SCD621-0660-2-3-145HA03-HP358	31036301
6,80	8	79	34	24	36	SCD621-0680-2-3-145HA03-HP358	31036303
6,90	8	79	34	24	36	SCD621-0690-2-3-145HA03-HP358	31036304
7,00	8	79	34	24	36	SCD621-0700-2-3-145HA03-HP358	31036305
7,15	8	79	41	29	36	SCD621-0715-2-3-145HA03-HP358	31307529

MEGA-Speed-Drill-Steel | Solid carbide twist drill SCD621 (3xD), internal coolant supply

Dimensions						Shank form HA	
d ₁ h7	d ₂ h6	l ₁	l ₂	l ₃	l ₄	Specification	Order no.
7,30	8	79	41	29	36	SCD621-0730-2-3-145HA03-HP358	31036308
7,40	8	79	41	29	36	SCD621-0740-2-3-145HA03-HP358	31036309
7,50	8	79	41	29	36	SCD621-0750-2-3-145HA03-HP358	31036310
7,60	8	79	41	29	36	SCD621-0760-2-3-145HA03-HP358	31036311
7,70	8	79	41	29	36	SCD621-0770-2-3-145HA03-HP358	31036312
7,80	8	79	41	29	36	SCD621-0780-2-3-145HA03-HP358	31036313
8,00	8	79	41	29	36	SCD621-0800-2-3-145HA03-HP358	31036315
8,20	10	89	47	35	40	SCD621-0820-2-3-145HA03-HP358	31036317
8,50	10	89	47	35	40	SCD621-0850-2-3-145HA03-HP358	31036320
8,60	10	89	47	35	40	SCD621-0860-2-3-145HA03-HP358	31036321
8,70	10	89	47	35	40	SCD621-0870-2-3-145HA03-HP358	31036322
8,80	10	89	47	35	40	SCD621-0880-2-3-145HA03-HP358	31036323
8,90	10	89	47	35	40	SCD621-0890-2-3-145HA03-HP358	31036324
9,00	10	89	47	35	40	SCD621-0900-2-3-145HA03-HP358	31036325
9,10	10	89	47	35	40	SCD621-0910-2-3-145HA03-HP358	31036326
9,20	10	89	47	35	40	SCD621-0920-2-3-145HA03-HP358	31036327
9,30	10	89	47	35	40	SCD621-0930-2-3-145HA03-HP358	31036328
9,40	10	89	47	35	40	SCD621-0940-2-3-145HA03-HP358	31036329
9,50	10	89	47	35	40	SCD621-0950-2-3-145HA03-HP358	31036330
9,60	10	89	47	35	40	SCD621-0960-2-3-145HA03-HP358	31036331
9,80	10	89	47	35	40	SCD621-0980-2-3-145HA03-HP358	31036333
9,90	10	89	47	35	40	SCD621-0990-2-3-145HA03-HP358	31036334
10,00	10	89	47	35	40	SCD621-1000-2-3-145HA03-HP358	31036335
10,20	12	102	55	40	45	SCD621-1020-2-3-145HA03-HP358	31036337
10,30	12	102	55	40	45	SCD621-1030-2-3-145HA03-HP358	31036338
10,50	12	102	55	40	45	SCD621-1050-2-3-145HA03-HP358	31036340
11,00	12	102	55	40	45	SCD621-1100-2-3-145HA03-HP358	31036345
11,20	12	102	55	40	45	SCD621-1120-2-3-145HA03-HP358	31036347
11,50	12	102	55	40	45	SCD621-1150-2-3-145HA03-HP358	31036350
11,80	12	102	55	40	45	SCD621-1180-2-3-145HA03-HP358	31036353
11,90	12	102	55	40	45	SCD621-1190-2-3-145HA03-HP358	31036354
12,00	12	102	55	40	45	SCD621-1200-2-3-145HA03-HP358	31036355
13,00	14	107	60	43	45	SCD621-1300-2-3-145HA03-HP358	31036359
13,80	14	107	60	43	45	SCD621-1380-2-3-145HA03-HP358	31036361
14,00	14	107	60	43	45	SCD621-1400-2-3-145HA03-HP358	31036362
14,50	16	115	65	45	48	SCD621-1450-2-3-145HA03-HP358	31036364
15,00	16	115	65	45	48	SCD621-1500-2-3-145HA03-HP358	31036366
16,00	16	115	65	45	48	SCD621-1600-2-3-145HA03-HP358	31036370
17,00	18	123	73	51	48	SCD621-1700-2-3-145HA03-HP358	31036373
17,50	18	123	73	51	48	SCD621-1750-2-3-145HA03-HP358	31036374
18,00	18	123	73	51	48	SCD621-1800-2-3-145HA03-HP358	31036376
18,50	20	131	79	55	50	SCD621-1850-2-3-145HA03-HP358	31036377
20,00	20	131	79	55	50	SCD621-2000-2-3-145HA03-HP358	31036392

MEGA-Speed-Drill-Steel | Solid carbide twist drill SCD621 (3xD), internal coolant supply

Configurable features



Diameter:
Diameter in increments of
0.01 mm freely selectable



Shank form:
Shank form HB | HE

Specification:

SCD621-[diameter]-2-3-145[shank form]03-HP358

Example:

SCD621-0431-2-3-145HE03-HP358

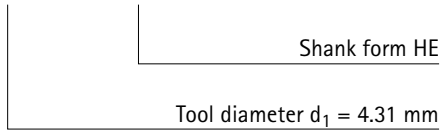

Dimensions of configurable series

d ₁ min.	d ₁ max.	d ₂ h6	l ₁	l ₂	l ₃	l ₄
3,00	3,70	6	62	20	14	36
3,71	4,70	6	66	24	17	36
4,71	6,00	6	66	28	20	36
6,01	6,80	8	79	34	24	36
6,81	8,00	8	79	41	29	36
8,01	10,00	10	89	47	35	40
10,01	12,00	12	102	55	40	45
12,01	14,00	14	107	60	43	45
14,01	16,00	16	115	65	45	48
16,01	18,00	18	123	73	51	48
18,01	20,00	20	131	79	55	50

Dimensions in mm.

For cutting data recommendations, see end of chapter.

Special designs and other coatings available upon request.

MEGA-Speed-Drill-Steel

Solid carbide twist drill

SCD621 (5xD), internal coolant supply, follow-up product to the MEGA-Speed-Drill-Uni (SCD22)

Design:

Drill diameter: 3.00 – 20.00 mm
 Bore tolerance: $\geq IT 9$
 Cutting material: HP358
 Number of cutting edges: 2
 Number of guiding chamfers: 3
 Tip angle: 145°
 Helix angle: 30°

Application:

For high-speed machining.

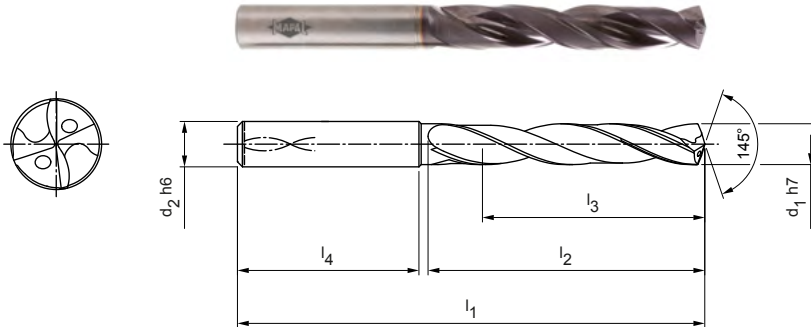

Stocked preferred series in shank form HA

Dimensions						Shank form HA	
d ₁ h7	d ₂ h6	l ₁	l ₂	l ₃	l ₄	Specification	Order no.
3,00	6	66	28	23	36	SCD621-0300-2-3-145HA05-HP358	30966287
3,10	6	66	28	23	36	SCD621-0310-2-3-145HA05-HP358	30966288
3,20	6	66	28	23	36	SCD621-0320-2-3-145HA05-HP358	30966289
3,30	6	66	28	23	36	SCD621-0330-2-3-145HA05-HP358	30966310
3,40	6	66	28	23	36	SCD621-0340-2-3-145HA05-HP358	30966311
3,50	6	66	28	23	36	SCD621-0350-2-3-145HA05-HP358	30959126
3,70	6	66	28	23	36	SCD621-0370-2-3-145HA05-HP358	30966313
3,80	6	74	36	29	36	SCD621-0380-2-3-145HA05-HP358	30966314
4,00	6	74	36	29	36	SCD621-0400-2-3-145HA05-HP358	30966316
4,20	6	74	36	29	36	SCD621-0420-2-3-145HA05-HP358	30966318
4,30	6	74	36	29	36	SCD621-0430-2-3-145HA05-HP358	30966319
4,50	6	74	36	29	36	SCD621-0450-2-3-145HA05-HP358	30966321
4,65	6	74	36	29	36	SCD621-0465-2-3-145HA05-HP358	31307540
4,70	6	74	36	29	36	SCD621-0470-2-3-145HA05-HP358	30966323
4,80	6	82	44	35	36	SCD621-0480-2-3-145HA05-HP358	30966324
4,90	6	82	44	35	36	SCD621-0490-2-3-145HA05-HP358	30966326
5,00	6	82	44	35	36	SCD621-0500-2-3-145HA05-HP358	30966327
5,10	6	82	44	35	36	SCD621-0510-2-3-145HA05-HP358	30966328
5,20	6	82	44	35	36	SCD621-0520-2-3-145HA05-HP358	30966329
5,30	6	82	44	35	36	SCD621-0530-2-3-145HA05-HP358	30966330
5,40	6	82	44	35	36	SCD621-0540-2-3-145HA05-HP358	30966331
5,50	6	82	44	35	36	SCD621-0550-2-3-145HA05-HP358	30966332
5,55	6	82	44	35	36	SCD621-0555-2-3-145HA05-HP358	31307541
5,60	6	82	44	35	36	SCD621-0560-2-3-145HA05-HP358	30966333
5,70	6	82	44	35	36	SCD621-0570-2-3-145HA05-HP358	30966334
5,80	6	82	44	35	36	SCD621-0580-2-3-145HA05-HP358	30966335
5,90	6	82	44	35	36	SCD621-0590-2-3-145HA05-HP358	30966336
6,00	6	82	44	35	36	SCD621-0600-2-3-145HA05-HP358	30966337
6,10	8	91	53	43	36	SCD621-0610-2-3-145HA05-HP358	30966338
6,20	8	91	53	43	36	SCD621-0620-2-3-145HA05-HP358	30966339
6,30	8	91	53	43	36	SCD621-0630-2-3-145HA05-HP358	30966340
6,50	8	91	53	43	36	SCD621-0650-2-3-145HA05-HP358	30966342
6,70	8	91	53	43	36	SCD621-0670-2-3-145HA05-HP358	30966344
6,80	8	91	53	43	36	SCD621-0680-2-3-145HA05-HP358	30966345

MEGA-Speed-Drill-Steel | Solid carbide twist drill SCD621 (5xD), internal coolant supply

Dimensions						Shank form HA	
d ₁ h7	d ₂ h6	l ₁	l ₂	l ₃	l ₄	Specification	Order no.
6,90	8	91	53	43	36	SCD621-0690-2-3-145HA05-HP358	30966346
7,00	8	91	53	43	36	SCD621-0700-2-3-145HA05-HP358	30966347
7,10	8	91	53	43	36	SCD621-0710-2-3-145HA05-HP358	30966348
7,20	8	91	53	43	36	SCD621-0720-2-3-145HA05-HP358	30966349
7,30	8	91	53	43	36	SCD621-0730-2-3-145HA05-HP358	30966350
7,40	8	91	53	43	36	SCD621-0740-2-3-145HA05-HP358	30966351
7,50	8	91	53	43	36	SCD621-0750-2-3-145HA05-HP358	30966352
7,60	8	91	53	43	36	SCD621-0760-2-3-145HA05-HP358	30966353
7,80	8	91	53	43	36	SCD621-0780-2-3-145HA05-HP358	30966355
8,00	8	91	53	43	36	SCD621-0800-2-3-145HA05-HP358	30948674
8,10	10	103	61	49	40	SCD621-0810-2-3-145HA05-HP358	30966357
8,20	10	103	61	49	40	SCD621-0820-2-3-145HA05-HP358	30966358
8,30	10	103	61	49	40	SCD621-0830-2-3-145HA05-HP358	30966359
8,40	10	103	61	49	40	SCD621-0840-2-3-145HA05-HP358	30966360
8,50	10	103	61	49	40	SCD621-0850-2-3-145HA05-HP358	30959302
8,60	10	103	61	49	40	SCD621-0860-2-3-145HA05-HP358	30966361
8,70	10	89	47	35	40	SCD621-0870-2-3-145HA05-HP358	30812607
8,80	10	103	61	49	40	SCD621-0880-2-3-145HA05-HP358	30966362
9,00	10	103	61	49	40	SCD621-0900-2-3-145HA05-HP358	30966364
9,10	10	103	61	49	40	SCD621-0910-2-3-145HA05-HP358	30966365
9,30	10	103	61	49	40	SCD621-0930-2-3-145HA05-HP358	30966367
9,40	10	103	61	49	40	SCD621-0940-2-3-145HA05-HP358	30966368
9,50	10	103	61	49	40	SCD621-0950-2-3-145HA05-HP358	30966369
9,70	10	103	61	49	40	SCD621-0970-2-3-145HA05-HP358	30958145
9,80	10	103	61	49	40	SCD621-0980-2-3-145HA05-HP358	30959402
9,90	10	103	61	49	40	SCD621-0990-2-3-145HA05-HP358	30966371
10,00	10	103	61	49	40	SCD621-1000-2-3-145HA05-HP358	30948675
10,20	12	118	71	56	45	SCD621-1020-2-3-145HA05-HP358	30966373
10,30	12	118	71	56	45	SCD621-1030-2-3-145HA05-HP358	30966374
10,50	12	118	71	56	45	SCD621-1050-2-3-145HA05-HP358	30966376
11,00	12	118	71	56	45	SCD621-1100-2-3-145HA05-HP358	30966381
11,10	12	118	71	56	45	SCD621-1110-2-3-145HA05-HP358	30966382
11,20	12	118	71	56	45	SCD621-1120-2-3-145HA05-HP358	30966383
11,30	12	118	71	56	45	SCD621-1130-2-3-145HA05-HP358	30966384
11,40	12	118	71	56	45	SCD621-1140-2-3-145HA05-HP358	30966385
11,50	12	118	71	56	45	SCD621-1150-2-3-145HA05-HP358	30966386
11,60	12	118	71	56	45	SCD621-1160-2-3-145HA05-HP358	30966387
11,80	12	118	71	56	45	SCD621-1180-2-3-145HA05-HP358	30966389
11,90	12	118	71	56	45	SCD621-1190-2-3-145HA05-HP358	30966390
12,00	12	118	71	56	45	SCD621-1200-2-3-145HA05-HP358	30948676
12,20	14	124	77	60	45	SCD621-1220-2-3-145HA05-HP358	30966391
12,50	14	124	77	60	45	SCD621-1250-2-3-145HA05-HP358	30966392
12,80	14	124	77	60	45	SCD621-1280-2-3-145HA05-HP358	30980599
13,00	14	124	77	60	45	SCD621-1300-2-3-145HA05-HP358	30966393
13,50	14	124	77	60	45	SCD621-1350-2-3-145HA05-HP358	30966394
13,80	14	124	77	60	45	SCD621-1380-2-3-145HA05-HP358	30966395
14,00	14	124	77	60	45	SCD621-1400-2-3-145HA05-HP358	30966396
14,20	16	133	83	63	48	SCD621-1420-2-3-145HA05-HP358	30966397
14,50	16	133	83	63	48	SCD621-1450-2-3-145HA05-HP358	30966398
15,00	16	133	83	63	48	SCD621-1500-2-3-145HA05-HP358	30966400
15,20	16	133	83	63	48	SCD621-1520-2-3-145HA05-HP358	30966401
15,50	16	133	83	63	48	SCD621-1550-2-3-145HA05-HP358	30966402
16,00	16	133	83	63	48	SCD621-1600-2-3-145HA05-HP358	30966404
16,50	18	143	93	71	48	SCD621-1650-2-3-145HA05-HP358	30966405
17,00	18	143	93	71	48	SCD621-1700-2-3-145HA05-HP358	30966407
17,50	18	143	93	71	48	SCD621-1750-2-3-145HA05-HP358	30966408

Continued on next page.

MEGA-Speed-Drill-Steel | Solid carbide twist drill SCD621 (5xD), internal coolant supply

Dimensions						Shank form HA	
d ₁ h7	d ₂ h6	l ₁	l ₂	l ₃	l ₄	Specification	Order no.
18,00	18	143	93	71	48	SCD621-1800-2-3-145HA05-HP358	30966410
18,50	20	153	101	77	50	SCD621-1850-2-3-145HA05-HP358	30966411
19,80	20	153	101	77	50	SCD621-1980-2-3-145HA05-HP358	30966415
20,00	20	153	101	77	50	SCD621-2000-2-3-145HA05-HP358	30966416

Configurable features

**Diameter:**

Diameter in increments of 0.01 mm freely selectable

**Shank form:**

Shank form: HB | HE

Specification:

SCD621-[diameter]-2-3-145[shank form]05-HP358

Example:

SCD621-0431-2-3-145HE05-HP358

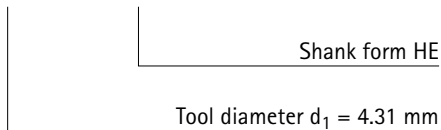

Dimensions of configurable series

d ₁ min.	d ₁ max.	d ₂ h6	l ₁	l ₂	l ₃	l ₄
3,00	3,70	6	66	28	23	36
3,71	4,70	6	74	36	29	36
4,71	6,00	6	82	44	35	36
6,01	6,80	8	91	53	43	36
6,81	8,00	8	91	53	43	36
8,01	9,00	10	103	61	49	40
9,01	10,00	10	103	61	49	40
10,01	11,00	12	118	71	56	45
11,01	12,00	12	118	71	56	45
12,01	14,00	14	124	77	60	45
14,01	16,00	16	133	83	63	48
16,01	18,00	18	143	93	71	48
18,01	20,00	20	153	101	77	50

Dimensions in mm.

For cutting data recommendations, see end of chapter.

Special designs and other coatings available upon request.

MEGA-Speed-Drill-Steel

Solid carbide twist drill

SCD621 (8xD), internal coolant supply, follow-up product to the MEGA-Speed-Drill-Uni (SCD22)

Design:

Drill diameter: 3.00 – 20.00 mm
 Bore tolerance: IT 9 (achievable)
 Cutting material: HP358
 Number of cutting edges: 2
 Number of guiding chamfers: 3
 Tip angle: 145°
 Helix angle: 30°

Application:

For high-speed machining.

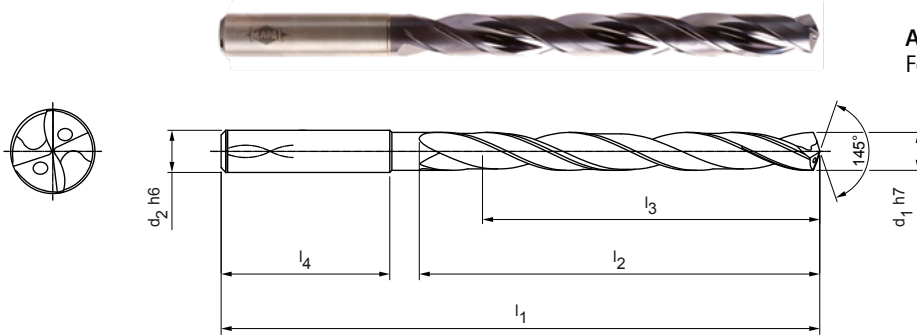

Stocked preferred series in shank form HA

Dimensions						Shank form HA	
d ₁ h7	d ₂ h6	l ₁	l ₂	l ₃	l ₄	Specification	Order no.
3,00	6	72	34	29	36	SCD621-0300-2-3-145HA08-HP358	31036147
3,10	6	72	34	29	36	SCD621-0310-2-3-145HA08-HP358	31036148
3,20	6	72	34	29	36	SCD621-0320-2-3-145HA08-HP358	31036149
3,30	6	72	34	29	36	SCD621-0330-2-3-145HA08-HP358	31036150
3,40	6	72	34	29	36	SCD621-0340-2-3-145HA08-HP358	31036151
3,50	6	72	34	29	36	SCD621-0350-2-3-145HA08-HP358	31036152
3,70	6	72	34	29	36	SCD621-0370-2-3-145HA08-HP358	31036154
4,00	6	81	43	36	36	SCD621-0400-2-3-145HA08-HP358	31036157
4,10	6	81	43	36	36	SCD621-0410-2-3-145HA08-HP358	31036158
4,20	6	81	43	36	36	SCD621-0420-2-3-145HA08-HP358	31036159
4,30	6	81	43	36	36	SCD621-0430-2-3-145HA08-HP358	31036160
4,50	6	81	43	36	36	SCD621-0450-2-3-145HA08-HP358	31036162
4,65	6	81	43	36	36	SCD621-0465-2-3-145HA08-HP358	31307542
4,80	6	95	57	48	36	SCD621-0480-2-3-145HA08-HP358	31036165
4,90	6	95	57	48	36	SCD621-0490-2-3-145HA08-HP358	31036166
5,00	6	95	57	48	36	SCD621-0500-2-3-145HA08-HP358	31036167
5,10	6	95	57	48	36	SCD621-0510-2-3-145HA08-HP358	31036168
5,20	6	95	57	48	36	SCD621-0520-2-3-145HA08-HP358	31036169
5,40	6	95	57	48	36	SCD621-0540-2-3-145HA08-HP358	31036171
5,50	6	95	57	48	36	SCD621-0550-2-3-145HA08-HP358	31036172
5,55	6	95	57	48	36	SCD621-0555-2-3-145HA08-HP358	31307543
5,60	6	95	57	48	36	SCD621-0560-2-3-145HA08-HP358	31036173
5,80	6	95	57	48	36	SCD621-0580-2-3-145HA08-HP358	31036175
5,90	6	95	57	48	36	SCD621-0590-2-3-145HA08-HP358	31036176
6,00	6	95	57	48	36	SCD621-0600-2-3-145HA08-HP358	31036177
6,10	8	114	76	64	36	SCD621-0610-2-3-145HA08-HP358	31036178
6,20	8	114	76	64	36	SCD621-0620-2-3-145HA08-HP358	31036179
6,50	8	114	76	64	36	SCD621-0650-2-3-145HA08-HP358	31036182
6,80	8	114	76	64	36	SCD621-0680-2-3-145HA08-HP358	31036185
6,90	8	114	76	64	36	SCD621-0690-2-3-145HA08-HP358	31036186
7,00	8	114	76	64	36	SCD621-0700-2-3-145HA08-HP358	31036187
7,50	8	114	76	64	36	SCD621-0750-2-3-145HA08-HP358	31036192
7,80	8	114	76	64	36	SCD621-0780-2-3-145HA08-HP358	31036195
8,00	8	114	76	64	36	SCD621-0800-2-3-145HA08-HP358	31036197
8,10	10	142	95	80	40	SCD621-0810-2-3-145HA08-HP358	31036198

MEGA-Speed-Drill-Steel | Solid carbide twist drill SCD621 (8xD), internal coolant supply

Dimensions						Shank form HA	
d ₁ h7	d ₂ h6	l ₁	l ₂	l ₃	l ₄	Specification	Order no.
8,50	10	142	95	80	40	SCD621-0850-2-3-145HA08-HP358	31036202
9,00	10	142	95	80	40	SCD621-0900-2-3-145HA08-HP358	31036207
9,50	10	142	95	80	40	SCD621-0950-2-3-145HA08-HP358	31036212
9,80	10	142	95	80	40	SCD621-0980-2-3-145HA08-HP358	31036215
10,00	10	142	95	80	40	SCD621-1000-2-3-145HA08-HP358	31036217
10,20	12	162	114	96	45	SCD621-1020-2-3-145HA08-HP358	31036219
10,30	12	162	114	96	45	SCD621-1030-2-3-145HA08-HP358	31036220
10,50	12	162	114	96	45	SCD621-1050-2-3-145HA08-HP358	31036222
11,00	12	162	114	96	45	SCD621-1100-2-3-145HA08-HP358	31036227
11,80	12	162	114	96	45	SCD621-1180-2-3-145HA08-HP358	31036235
12,00	12	162	114	96	45	SCD621-1200-2-3-145HA08-HP358	31036237
12,50	14	178	133	112	45	SCD621-1250-2-3-145HA08-HP358	31036239
13,00	14	178	133	112	45	SCD621-1300-2-3-145HA08-HP358	31036241
13,50	14	178	133	112	45	SCD621-1350-2-3-145HA08-HP358	31036242
14,00	14	178	133	112	45	SCD621-1400-2-3-145HA08-HP358	31036244
15,00	16	203	152	128	48	SCD621-1500-2-3-145HA08-HP358	31036248
15,80	16	203	152	128	48	SCD621-1580-2-3-145HA08-HP358	31036251
16,00	16	203	152	128	48	SCD621-1600-2-3-145HA08-HP358	31036252
19,00	20	243	190	160	50	SCD621-1900-2-3-145HA08-HP358	31036261
19,80	20	243	190	160	50	SCD621-1980-2-3-145HA08-HP358	31036263

Configurable features



Diameter:
Diameter in increments of
0.01 mm freely selectable



Shank form:
Shank form: HB | HE

Specification:

SCD621-[diameter]-2-3-145[shank form]08-HP358

Example:

SCD621-0431-2-3-145HE08-HP358

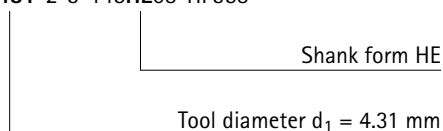

Dimensions of configurable series

d ₁ min.	d ₁ max.	d ₂ h6	l ₁	l ₂	l ₃	l ₄
3,00	3,70	6	72	34	29	36
3,71	4,70	6	81	43	36	36
4,71	6,00	6	95	57	48	36
6,01	6,80	8	114	76	64	36
6,81	8,00	8	114	76	64	36
8,01	9,00	10	142	95	80	40
9,01	10,00	10	142	95	80	40
10,01	11,00	12	162	114	96	45
11,01	12,00	12	162	114	96	45
12,01	14,00	14	178	133	112	45
14,01	16,00	16	203	152	128	48
16,01	18,00	18	222	171	144	48
18,01	20,00	20	243	190	160	50

Dimensions in mm.

For cutting data recommendations, see end of chapter.

Special designs and other coatings available upon request.

MEGA-Speed-Drill-Steel

Solid carbide twist drill

SCD621 (12xD), internal coolant supply, follow-up product to the MEGA-Speed-Drill-Uni (SCD22)

Design:

Drill diameter: 3.00 – 20.00 mm
 Bore tolerance: \geq IT 9
 Cutting material: HP358
 Number of cutting edges: 2
 Number of guiding chamfers: 3
 Tip angle: 145°
 Helix angle: 30°

Application:

For high-speed machining.

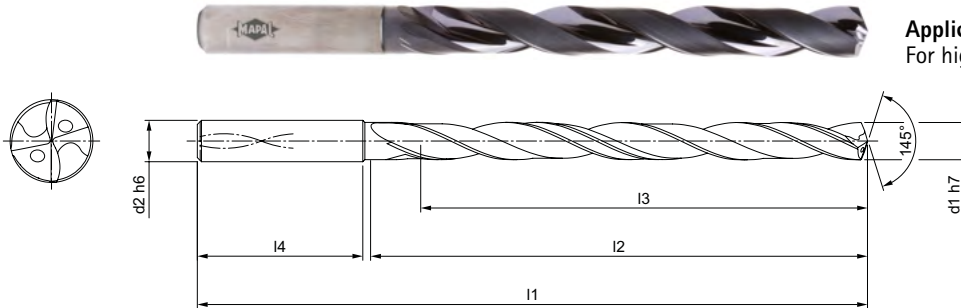

Stocked preferred series in shank form HA

Dimensions						Shank form HA	
d ₁ h7	d ₂ h6	l ₁	l ₂	l ₃	l ₄	Specification	Order no.
3,00	6	92	54	48	36	SCD621-0300-2-3-145HA12-HP358	31239148
3,20	6	92	54	48	36	SCD621-0320-2-3-145HA12-HP358	31239150
3,30	6	92	54	48	36	SCD621-0330-2-3-145HA12-HP358	31239151
3,40	6	92	54	48	36	SCD621-0340-2-3-145HA12-HP358	31239152
3,50	6	92	54	48	36	SCD621-0350-2-3-145HA12-HP358	31239153
3,70	6	92	54	48	36	SCD621-0370-2-3-145HA12-HP358	31239155
4,00	6	102	64	58	36	SCD621-0400-2-3-145HA12-HP358	31239158
4,10	6	102	64	58	36	SCD621-0410-2-3-145HA12-HP358	31239159
4,20	6	102	64	58	36	SCD621-0420-2-3-145HA12-HP358	31239160
4,30	6	102	64	58	36	SCD621-0430-2-3-145HA12-HP358	31239161
4,50	6	102	64	58	36	SCD621-0450-2-3-145HA12-HP358	31239163
4,80	6	116	78	70	36	SCD621-0480-2-3-145HA12-HP358	31239166
5,00	6	116	78	70	36	SCD621-0500-2-3-145HA12-HP358	31239168
5,10	6	116	78	70	36	SCD621-0510-2-3-145HA12-HP358	31239169
5,20	6	116	78	70	36	SCD621-0520-2-3-145HA12-HP358	31239170
5,40	6	116	78	70	36	SCD621-0540-2-3-145HA12-HP358	31239172
5,50	6	116	78	70	36	SCD621-0550-2-3-145HA12-HP358	31239173
5,80	6	116	78	70	36	SCD621-0580-2-3-145HA12-HP358	31239176
6,00	6	116	78	70	36	SCD621-0600-2-3-145HA12-HP358	31239178
6,10	8	146	108	94	36	SCD621-0610-2-3-145HA12-HP358	31239179
6,50	8	146	108	94	36	SCD621-0650-2-3-145HA12-HP358	31239183
6,80	8	146	108	94	36	SCD621-0680-2-3-145HA12-HP358	31239186
7,00	8	146	108	94	36	SCD621-0700-2-3-145HA12-HP358	31239188
7,50	8	146	108	94	36	SCD621-0750-2-3-145HA12-HP358	31239193
7,80	8	146	108	94	36	SCD621-0780-2-3-145HA12-HP358	31239196
8,00	8	146	108	94	36	SCD621-0800-2-3-145HA12-HP358	31239198
8,50	10	162	120	110	40	SCD621-0850-2-3-145HA12-HP358	31239203
9,00	10	162	120	110	40	SCD621-0900-2-3-145HA12-HP358	31239208
9,50	10	162	120	110	40	SCD621-0950-2-3-145HA12-HP358	31239213
9,80	10	162	120	110	40	SCD621-0980-2-3-145HA12-HP358	31239216
10,00	10	162	120	110	40	SCD621-1000-2-3-145HA12-HP358	31239218
10,20	12	204	156	142	45	SCD621-1020-2-3-145HA12-HP358	31239220
10,50	12	204	156	142	45	SCD621-1050-2-3-145HA12-HP358	31239223
11,00	12	204	156	142	45	SCD621-1100-2-3-145HA12-HP358	31239228
11,80	12	204	156	142	45	SCD621-1180-2-3-145HA12-HP358	31239236

MEGA-Speed-Drill-Steel | Solid carbide twist drill SCD621 (12xD), internal coolant supply

Dimensions						Shank form HA	
d ₁ h7	d ₂ h6	l ₁	l ₂	l ₃	l ₄	Specification	Order no.
12,00	12	204	156	142	45	SCD621-1200-2-3-145HA12-HP358	31239238
12,50	14	230	182	166	45	SCD621-1250-2-3-145HA12-HP358	31239240
13,00	14	230	182	166	45	SCD621-1300-2-3-145HA12-HP358	31239242
13,50	14	230	182	166	45	SCD621-1350-2-3-145HA12-HP358	31239243
14,00	14	230	182	166	45	SCD621-1400-2-3-145HA12-HP358	31239245
15,00	16	260	208	192	48	SCD621-1500-2-3-145HA12-HP358	31239248
16,00	16	260	208	192	48	SCD621-1600-2-3-145HA12-HP358	31239253

Configurable features

**Diameter:**

Diameter in increments of 0.01 mm freely selectable

**Shank form:**

Shank form: HB | HE

Specification:

SCD621-[diameter]-2-3-145[shank form]12-HP358

Example:

SCD621-0431-2-3-145HE12-HP358

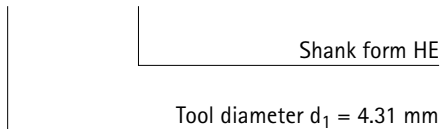

Dimensions of configurable series

d ₁ min.	d ₁ max.	d ₂ h6	l ₁	l ₂	l ₃	l ₄
3,00	3,70	6	92	54	48	36
3,71	4,70	6	102	64	58	36
4,71	6,00	6	116	78	70	36
6,01	6,80	8	146	108	94	36
6,81	8,00	8	146	108	94	36
8,01	9,00	10	162	120	110	40
9,01	10,00	10	162	120	110	40
10,01	11,00	12	204	156	142	45
11,01	12,00	12	204	156	142	45
12,01	14,00	14	230	182	166	45
14,01	16,00	16	260	208	192	48
16,01	18,00	18	285	234	216	48
18,01	20,00	20	310	258	240	50

Dimensions in mm.

For cutting data recommendations, see end of chapter.

Special designs and other coatings available upon request.

MEGA 180° Drill

Solid carbide twist drill
SCD231 (3xD), internal coolant supply

Design:
 Drill diameter: 3.00 – 20.00 mm
 Bore tolerance: ≥ IT 9
 Cutting material: HP230
 Number of cutting edges: 2
 Number of guiding chamfers: 4
 Tip angle: 180°
 Helix angle: 30°

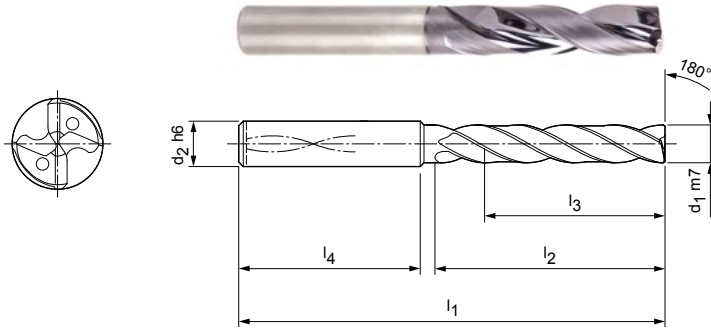

Stocked preferred series in shank form HA

Dimensions						Shank form HA	
d ₁ m7	d ₂ h6	l ₁	l ₂	l ₃	l ₄	Specification	Order no.
3,00	6	62	20	14	36	SCD231-0300-2-4-180HA03-HP230	30382647
3,10	6	62	20	14	36	SCD231-0310-2-4-180HA03-HP230	30382648
3,20	6	62	20	14	36	SCD231-0320-2-4-180HA03-HP230	30382649
3,30	6	62	20	14	36	SCD231-0330-2-4-180HA03-HP230	30382650
3,40	6	62	20	14	36	SCD231-0340-2-4-180HA03-HP230	30382651
3,50	6	62	20	14	36	SCD231-0350-2-4-180HA03-HP230	30382652
3,60	6	62	20	14	36	SCD231-0360-2-4-180HA03-HP230	30382653
3,70	6	62	20	14	36	SCD231-0370-2-4-180HA03-HP230	30382654
3,80	6	66	24	17	36	SCD231-0380-2-4-180HA03-HP230	30382655
3,90	6	66	24	17	36	SCD231-0390-2-4-180HA03-HP230	30382656
4,00	6	66	24	17	36	SCD231-0400-2-4-180HA03-HP230	30382657
4,10	6	66	24	17	36	SCD231-0410-2-4-180HA03-HP230	30382658
4,20	6	66	24	17	36	SCD231-0420-2-4-180HA03-HP230	30382659
4,30	6	66	24	17	36	SCD231-0430-2-4-180HA03-HP230	30382660
4,40	6	66	24	17	36	SCD231-0440-2-4-180HA03-HP230	30382661
4,50	6	66	24	17	36	SCD231-0450-2-4-180HA03-HP230	30382662
4,60	6	66	24	17	36	SCD231-0460-2-4-180HA03-HP230	30382663
4,65	6	66	24	17	36	SCD231-0465-2-4-180HA03-HP230	30382664
4,70	6	66	24	17	36	SCD231-0470-2-4-180HA03-HP230	30382665
4,80	6	66	28	20	36	SCD231-0480-2-4-180HA03-HP230	30382666
4,90	6	66	28	20	36	SCD231-0490-2-4-180HA03-HP230	30382667
5,00	6	66	28	20	36	SCD231-0500-2-4-180HA03-HP230	30382668
5,10	6	66	28	20	36	SCD231-0510-2-4-180HA03-HP230	30382669
5,20	6	66	28	20	36	SCD231-0520-2-4-180HA03-HP230	30382670
5,30	6	66	28	20	36	SCD231-0530-2-4-180HA03-HP230	30382671
5,40	6	66	28	20	36	SCD231-0540-2-4-180HA03-HP230	30382672
5,50	6	66	28	20	36	SCD231-0550-2-4-180HA03-HP230	30382673
5,55	6	66	28	20	36	SCD231-0555-2-4-180HA03-HP230	30382674
5,60	6	66	28	20	36	SCD231-0560-2-4-180HA03-HP230	30382675
5,70	6	66	28	20	36	SCD231-0570-2-4-180HA03-HP230	30382676
5,80	6	66	28	20	36	SCD231-0580-2-4-180HA03-HP230	30382677
5,90	6	66	28	20	36	SCD231-0590-2-4-180HA03-HP230	30382678
6,00	6	66	28	20	36	SCD231-0600-2-4-180HA03-HP230	30382679
6,10	8	79	34	24	36	SCD231-0610-2-4-180HA03-HP230	30382680
6,20	8	79	34	24	36	SCD231-0620-2-4-180HA03-HP230	30382681

MEGA-180°-Drill | Solid carbide twist drill SCD231 (3xD), internal coolant supply

Dimensions						Shank form HA	
d ₁ m7	d ₂ h6	l ₁	l ₂	l ₃	l ₄	Specification	Order no.
6,30	8	79	34	24	36	SCD231-0630-2-4-180HA03-HP230	30382682
6,40	8	79	34	24	36	SCD231-0640-2-4-180HA03-HP230	30382683
6,50	8	79	34	24	36	SCD231-0650-2-4-180HA03-HP230	30382684
6,60	8	79	34	24	36	SCD231-0660-2-4-180HA03-HP230	30382685
6,70	8	79	34	24	36	SCD231-0670-2-4-180HA03-HP230	30382686
6,80	8	79	34	24	36	SCD231-0680-2-4-180HA03-HP230	30382687
6,90	8	79	34	24	36	SCD231-0690-2-4-180HA03-HP230	30382688
7,00	8	79	34	24	36	SCD231-0700-2-4-180HA03-HP230	30382689
7,10	8	79	41	29	36	SCD231-0710-2-4-180HA03-HP230	30382690
7,20	8	79	41	29	36	SCD231-0720-2-4-180HA03-HP230	30382691
7,30	8	79	41	29	36	SCD231-0730-2-4-180HA03-HP230	30382692
7,40	8	79	41	29	36	SCD231-0740-2-4-180HA03-HP230	30382693
7,50	8	79	41	29	36	SCD231-0750-2-4-180HA03-HP230	30382694
7,60	8	79	41	29	36	SCD231-0760-2-4-180HA03-HP230	30382695
7,70	8	79	41	29	36	SCD231-0770-2-4-180HA03-HP230	30382696
7,80	8	79	41	29	36	SCD231-0780-2-4-180HA03-HP230	30382697
7,90	8	79	41	29	36	SCD231-0790-2-4-180HA03-HP230	30382698
8,00	8	79	41	29	36	SCD231-0800-2-4-180HA03-HP230	30382699
8,10	10	89	47	35	40	SCD231-0810-2-4-180HA03-HP230	30382700
8,20	10	89	47	35	40	SCD231-0820-2-4-180HA03-HP230	30382701
8,30	10	89	47	35	40	SCD231-0830-2-4-180HA03-HP230	30382702
8,40	10	89	47	35	40	SCD231-0840-2-4-180HA03-HP230	30382703
8,50	10	89	47	35	40	SCD231-0850-2-4-180HA03-HP230	30382704
8,60	10	89	47	35	40	SCD231-0860-2-4-180HA03-HP230	30382705
8,70	10	89	47	35	40	SCD231-0870-2-4-180HA03-HP230	30382706
8,80	10	89	47	35	40	SCD231-0880-2-4-180HA03-HP230	30382707
8,90	10	89	47	35	40	SCD231-0890-2-4-180HA03-HP230	30382708
9,00	10	89	47	35	40	SCD231-0900-2-4-180HA03-HP230	30382709
9,10	10	89	47	35	40	SCD231-0910-2-4-180HA03-HP230	30382710
9,20	10	89	47	35	40	SCD231-0920-2-4-180HA03-HP230	30382711
9,30	10	89	47	35	40	SCD231-0930-2-4-180HA03-HP230	30382712
9,40	10	89	47	35	40	SCD231-0940-2-4-180HA03-HP230	30382713
9,50	10	89	47	35	40	SCD231-0950-2-4-180HA03-HP230	30382714
9,60	10	89	47	35	40	SCD231-0960-2-4-180HA03-HP230	30382715
9,70	10	89	47	35	40	SCD231-0970-2-4-180HA03-HP230	30382716
9,80	10	89	47	35	40	SCD231-0980-2-4-180HA03-HP230	30382717
9,90	10	89	47	35	40	SCD231-0990-2-4-180HA03-HP230	30382718
10,00	10	89	47	35	40	SCD231-1000-2-4-180HA03-HP230	30382719
10,10	12	100	53	38	45	SCD231-1010-2-4-180HA03-HP230	30382720
10,20	12	100	53	38	45	SCD231-1020-2-4-180HA03-HP230	30382721
10,30	12	100	53	38	45	SCD231-1030-2-4-180HA03-HP230	30382722
10,40	12	100	53	38	45	SCD231-1040-2-4-180HA03-HP230	30382723
10,50	12	100	53	38	45	SCD231-1050-2-4-180HA03-HP230	30382724
10,60	12	100	53	38	45	SCD231-1060-2-4-180HA03-HP230	30382725
10,70	12	100	53	38	45	SCD231-1070-2-4-180HA03-HP230	30382726
10,80	12	100	53	38	45	SCD231-1080-2-4-180HA03-HP230	30382727
11,00	12	100	53	38	45	SCD231-1100-2-4-180HA03-HP230	30382729
11,10	12	100	53	38	45	SCD231-1110-2-4-180HA03-HP230	30382730
11,20	12	100	53	38	45	SCD231-1120-2-4-180HA03-HP230	30382731
11,30	12	100	53	38	45	SCD231-1130-2-4-180HA03-HP230	30382732
11,40	12	100	53	38	45	SCD231-1140-2-4-180HA03-HP230	30382733
11,50	12	100	53	38	45	SCD231-1150-2-4-180HA03-HP230	30382734
11,60	12	100	53	38	45	SCD231-1160-2-4-180HA03-HP230	30382735
11,70	12	100	53	38	45	SCD231-1170-2-4-180HA03-HP230	30382736
11,80	12	100	53	38	45	SCD231-1180-2-4-180HA03-HP230	30382737
11,90	12	100	53	38	45	SCD231-1190-2-4-180HA03-HP230	30382738
12,00	12	100	53	38	45	SCD231-1200-2-4-180HA03-HP230	30382739

MEGA-180°-Drill | Solid carbide twist drill SCD231 (3xD), internal coolant supply

Dimensions						Shank form HA	
d ₁ m7	d ₂ h6	l ₁	l ₂	l ₃	l ₄	Specification	Order no.
12,50	14	105	58	41	45	SCD231-1250-2-4-180HA03-HP230	30382740
12,70	14	105	58	41	45	SCD231-1270-2-4-180HA03-HP230	30852019
12,80	14	105	58	41	45	SCD231-1280-2-4-180HA03-HP230	30382741
13,00	14	105	58	41	45	SCD231-1300-2-4-180HA03-HP230	30382742
13,50	14	105	58	41	45	SCD231-1350-2-4-180HA03-HP230	30382743
13,80	14	105	58	41	45	SCD231-1380-2-4-180HA03-HP230	30382744
14,00	14	105	58	41	45	SCD231-1400-2-4-180HA03-HP230	30382745
14,50	16	113	63	43	48	SCD231-1450-2-4-180HA03-HP230	30382746
14,80	16	113	63	43	48	SCD231-1480-2-4-180HA03-HP230	30382747
15,00	16	113	63	43	48	SCD231-1500-2-4-180HA03-HP230	30382748
15,50	16	113	63	43	48	SCD231-1550-2-4-180HA03-HP230	30382749
15,80	16	113	63	43	48	SCD231-1580-2-4-180HA03-HP230	30382750
16,00	16	113	63	43	48	SCD231-1600-2-4-180HA03-HP230	30382751
16,50	18	121	71	49	48	SCD231-1650-2-4-180HA03-HP230	30382752
16,80	18	121	71	49	48	SCD231-1680-2-4-180HA03-HP230	30382753
17,00	18	121	71	49	48	SCD231-1700-2-4-180HA03-HP230	30382754
17,50	18	121	71	49	48	SCD231-1750-2-4-180HA03-HP230	30382755
18,00	18	121	71	49	48	SCD231-1800-2-4-180HA03-HP230	30382757
18,50	20	129	77	53	50	SCD231-1850-2-4-180HA03-HP230	30382758
18,80	20	129	77	53	50	SCD231-1880-2-4-180HA03-HP230	30382759
19,00	20	129	77	53	50	SCD231-1900-2-4-180HA03-HP230	30382760
19,50	20	129	77	53	50	SCD231-1950-2-4-180HA03-HP230	30382761
20,00	20	129	77	53	50	SCD231-2000-2-4-180HA03-HP230	30382763

Configurable features



Diameter:
Diameter in increments of
0.01 mm freely selectable



Shank form:
Shank form: HB | HE

Specification:

SCD231-[diameter]-2-4-180[shank form]03-HP230

Dimensions of configurable series

d ₁ min.	d ₁ max.	d ₂ h6	l ₁	l ₂	l ₃	l ₄
3,00	3,70	6	62	20	14	36
3,71	4,70	6	66	24	17	36
4,71	6,00	6	66	28	20	36
6,01	6,80	8	79	34	24	36
6,81	8,00	8	79	41	29	36
8,01	10,00	10	89	47	35	40
10,01	12,00	12	100	53	38	45
12,01	14,00	14	105	58	41	45
14,01	16,00	16	113	63	43	48
16,01	18,00	18	121	71	49	48
18,01	20,00	20	129	77	53	50

Example:

SCD231-0431-2-4-180HE03-HP230

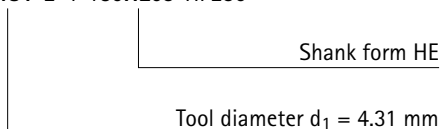

Dimensions in mm.

For cutting data recommendations, see end of chapter.

Special designs and other coatings available upon request.

MEGA 180° Drill

Solid carbide twist drill
SCD231 (5xD), internal coolant supply

Design:
 Drill diameter: 3.00 – 20.00 mm
 Bore tolerance: ≥ IT 9
 Cutting material: HP230
 Number of cutting edges: 2
 Number of guiding chamfers: 4
 Tip angle: 180°
 Helix angle: 30°

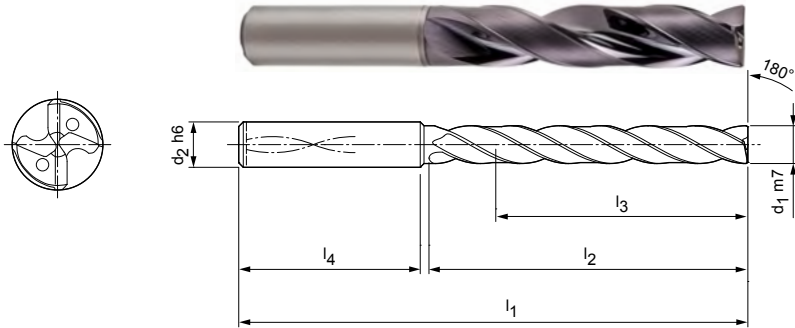

Stocked preferred series in shank form HA

Dimensions						Shank form HA	
d ₁ m7	d ₂ h6	l ₁	l ₂	l ₃	l ₄	Specification	Order no.
3,00	6	66	28	23	36	SCD231-0300-2-4-180HA05-HP230	30382764
3,10	6	66	28	23	36	SCD231-0310-2-4-180HA05-HP230	30382765
3,20	6	66	28	23	36	SCD231-0320-2-4-180HA05-HP230	30382766
3,30	6	66	28	23	36	SCD231-0330-2-4-180HA05-HP230	30382767
3,40	6	66	28	23	36	SCD231-0340-2-4-180HA05-HP230	30382768
3,50	6	66	28	23	36	SCD231-0350-2-4-180HA05-HP230	30382769
3,60	6	66	28	23	36	SCD231-0360-2-4-180HA05-HP230	30382770
3,70	6	66	28	23	36	SCD231-0370-2-4-180HA05-HP230	30382771
3,80	6	74	36	29	36	SCD231-0380-2-4-180HA05-HP230	30382772
3,90	6	74	36	29	36	SCD231-0390-2-4-180HA05-HP230	30382773
4,00	6	74	36	29	36	SCD231-0400-2-4-180HA05-HP230	30382774
4,10	6	74	36	29	36	SCD231-0410-2-4-180HA05-HP230	30382775
4,20	6	74	36	29	36	SCD231-0420-2-4-180HA05-HP230	30382776
4,30	6	74	36	29	36	SCD231-0430-2-4-180HA05-HP230	30382777
4,40	6	74	36	29	36	SCD231-0440-2-4-180HA05-HP230	30382778
4,50	6	74	36	29	36	SCD231-0450-2-4-180HA05-HP230	30382779
4,60	6	74	36	29	36	SCD231-0460-2-4-180HA05-HP230	30382780
4,80	6	82	44	35	36	SCD231-0480-2-4-180HA05-HP230	30382783
4,90	6	82	44	35	36	SCD231-0490-2-4-180HA05-HP230	30382784
5,00	6	82	44	35	36	SCD231-0500-2-4-180HA05-HP230	30382785
5,10	6	82	44	35	36	SCD231-0510-2-4-180HA05-HP230	30382786
5,20	6	82	44	35	36	SCD231-0520-2-4-180HA05-HP230	30382787
5,30	6	82	44	35	36	SCD231-0530-2-4-180HA05-HP230	30382788
5,40	6	82	44	35	36	SCD231-0540-2-4-180HA05-HP230	30382789
5,50	6	82	44	35	36	SCD231-0550-2-4-180HA05-HP230	30382790
5,55	6	82	44	35	36	SCD231-0555-2-4-180HA05-HP230	30382791
5,60	6	82	44	35	36	SCD231-0560-2-4-180HA05-HP230	30382792
5,70	6	82	44	35	36	SCD231-0570-2-4-180HA05-HP230	30382793
5,80	6	82	44	35	36	SCD231-0580-2-4-180HA05-HP230	30382794
5,90	6	82	44	35	36	SCD231-0590-2-4-180HA05-HP230	30382795
6,00	6	82	44	35	36	SCD231-0600-2-4-180HA05-HP230	30382796
6,10	8	91	53	43	36	SCD231-0610-2-4-180HA05-HP230	30382797
6,20	8	91	53	43	36	SCD231-0620-2-4-180HA05-HP230	30382798
6,30	8	91	53	43	36	SCD231-0630-2-4-180HA05-HP230	30382799
6,40	8	91	53	43	36	SCD231-0640-2-4-180HA05-HP230	30382800

MEGA-180°-Drill | Solid carbide twist drill SCD231 (5xD), internal coolant supply

Dimensions						Shank form HA	
d ₁ m7	d ₂ h6	l ₁	l ₂	l ₃	l ₄	Specification	Order no.
6,50	8	91	53	43	36	SCD231-0650-2-4-180HA05-HP230	30382801
6,60	8	91	53	43	36	SCD231-0660-2-4-180HA05-HP230	30382802
6,70	8	91	53	43	36	SCD231-0670-2-4-180HA05-HP230	30382803
6,80	8	91	53	43	36	SCD231-0680-2-4-180HA05-HP230	30382804
6,90	8	91	53	43	36	SCD231-0690-2-4-180HA05-HP230	30382805
7,00	8	91	53	43	36	SCD231-0700-2-4-180HA05-HP230	30382806
7,10	8	91	53	43	36	SCD231-0710-2-4-180HA05-HP230	30382807
7,20	8	91	53	43	36	SCD231-0720-2-4-180HA05-HP230	30382808
7,30	8	91	53	43	36	SCD231-0730-2-4-180HA05-HP230	30382809
7,40	8	91	53	43	36	SCD231-0740-2-4-180HA05-HP230	30382810
7,50	8	91	53	43	36	SCD231-0750-2-4-180HA05-HP230	30382811
7,60	8	91	53	43	36	SCD231-0760-2-4-180HA05-HP230	30382812
7,80	8	91	53	43	36	SCD231-0780-2-4-180HA05-HP230	30382814
7,90	8	91	53	43	36	SCD231-0790-2-4-180HA05-HP230	30382815
8,00	8	91	53	43	36	SCD231-0800-2-4-180HA05-HP230	30382816
8,10	10	103	61	49	40	SCD231-0810-2-4-180HA05-HP230	30382817
8,20	10	103	61	49	40	SCD231-0820-2-4-180HA05-HP230	30382818
8,30	10	103	61	49	40	SCD231-0830-2-4-180HA05-HP230	30382819
8,40	10	103	61	49	40	SCD231-0840-2-4-180HA05-HP230	30382820
8,50	10	103	61	49	40	SCD231-0850-2-4-180HA05-HP230	30382821
8,60	10	103	61	49	40	SCD231-0860-2-4-180HA05-HP230	30382822
8,70	10	103	61	49	40	SCD231-0870-2-4-180HA05-HP230	30382823
8,80	10	103	61	49	40	SCD231-0880-2-4-180HA05-HP230	30382824
8,90	10	103	61	49	40	SCD231-0890-2-4-180HA05-HP230	30382825
9,00	10	103	61	49	40	SCD231-0900-2-4-180HA05-HP230	30382826
9,10	10	103	61	49	40	SCD231-0910-2-4-180HA05-HP230	30382827
9,20	10	103	61	49	40	SCD231-0920-2-4-180HA05-HP230	30382828
9,30	10	103	61	49	40	SCD231-0930-2-4-180HA05-HP230	30382829
9,40	10	103	61	49	40	SCD231-0940-2-4-180HA05-HP230	30382830
9,50	10	103	61	49	40	SCD231-0950-2-4-180HA05-HP230	30382831
9,60	10	103	61	49	40	SCD231-0960-2-4-180HA05-HP230	30382832
9,70	10	103	61	49	40	SCD231-0970-2-4-180HA05-HP230	30382833
9,80	10	103	61	49	40	SCD231-0980-2-4-180HA05-HP230	30382834
9,90	10	103	61	49	40	SCD231-0990-2-4-180HA05-HP230	30382835
10,00	10	103	61	49	40	SCD231-1000-2-4-180HA05-HP230	30382836
10,10	12	116	69	54	45	SCD231-1010-2-4-180HA05-HP230	30382838
10,20	12	116	69	54	45	SCD231-1020-2-4-180HA05-HP230	30382840
10,30	12	116	69	54	45	SCD231-1030-2-4-180HA05-HP230	30382841
10,40	12	116	69	54	45	SCD231-1040-2-4-180HA05-HP230	30382842
10,50	12	116	69	54	45	SCD231-1050-2-4-180HA05-HP230	30382843
10,60	12	116	69	54	45	SCD231-1060-2-4-180HA05-HP230	30382844
10,65	12	116	69	54	45	SCD231-1065-2-4-180HA05-HP230	31198519
10,80	12	116	69	54	45	SCD231-1080-2-4-180HA05-HP230	30382846
11,00	12	116	69	54	45	SCD231-1100-2-4-180HA05-HP230	30382848
11,20	12	116	69	54	45	SCD231-1120-2-4-180HA05-HP230	30382850
11,50	12	116	69	54	45	SCD231-1150-2-4-180HA05-HP230	30382853
11,60	12	116	69	54	45	SCD231-1160-2-4-180HA05-HP230	30382854
11,70	12	116	69	54	45	SCD231-1170-2-4-180HA05-HP230	30382855
11,80	12	116	69	54	45	SCD231-1180-2-4-180HA05-HP230	30382856
12,00	12	116	69	54	45	SCD231-1200-2-4-180HA05-HP230	30382858
12,50	14	122	75	58	45	SCD231-1250-2-4-180HA05-HP230	30382859
12,80	14	122	75	58	45	SCD231-1280-2-4-180HA05-HP230	30382860
13,00	14	122	75	58	45	SCD231-1300-2-4-180HA05-HP230	30382861
13,50	14	122	75	58	45	SCD231-1350-2-4-180HA05-HP230	30382862
13,80	14	122	75	58	45	SCD231-1380-2-4-180HA05-HP230	30382863
14,00	14	122	75	58	45	SCD231-1400-2-4-180HA05-HP230	30382864
14,50	16	131	81	61	48	SCD231-1450-2-4-180HA05-HP230	30382865

Continued on next page.

MEGA-180°-Drill | Solid carbide twist drill SCD231 (5xD), internal coolant supply

Dimensions						Shank form HA	
d ₁ m7	d ₂ h6	l ₁	l ₂	l ₃	l ₄	Specification	Order no.
14,80	16	131	81	61	48	SCD231-1480-2-4-180HA05-HP230	30382866
15,00	16	131	81	61	48	SCD231-1500-2-4-180HA05-HP230	30382867
15,50	16	131	81	61	48	SCD231-1550-2-4-180HA05-HP230	30382868
15,80	16	131	81	61	48	SCD231-1580-2-4-180HA05-HP230	30382869
16,00	16	131	81	61	48	SCD231-1600-2-4-180HA05-HP230	30382870
16,50	18	141	91	69	48	SCD231-1650-2-4-180HA05-HP230	30382871
17,00	18	141	91	69	48	SCD231-1700-2-4-180HA05-HP230	30382873
17,50	18	141	91	69	48	SCD231-1750-2-4-180HA05-HP230	30382874
17,80	18	141	91	69	48	SCD231-1780-2-4-180HA05-HP230	30382875
18,00	18	141	91	69	48	SCD231-1800-2-4-180HA05-HP230	30382876
18,50	20	151	99	75	50	SCD231-1850-2-4-180HA05-HP230	30382877
19,00	20	151	99	75	50	SCD231-1900-2-4-180HA05-HP230	30382879
19,80	20	151	99	75	50	SCD231-1980-2-4-180HA05-HP230	30382881
20,00	20	151	99	75	50	SCD231-2000-2-4-180HA05-HP230	30382882

Configurable features

**Diameter:**

Diameter in increments of 0.01 mm freely selectable

**Shank form:**

Shank form: HB | HE

Specification:

SCD231-[diameter]-2-4-180[shank form]05-HP230

Dimensions of configurable series

d ₁ min.	d ₁ max.	d ₂ h6	l ₁	l ₂	l ₃	l ₄
3,00	3,70	6	66	28	23	36
3,71	4,70	6	74	36	29	36
4,71	6,00	6	82	44	35	36
6,01	8,00	8	91	53	43	36
8,01	10,00	10	103	61	49	40
10,01	12,00	12	116	69	54	45
12,01	14,00	14	122	75	58	45
14,01	16,00	16	131	81	61	48
16,01	18,00	18	141	91	69	48
18,01	20,00	20	151	99	75	50

Example:

SCD231-0431-2-4-180HE05-HP230

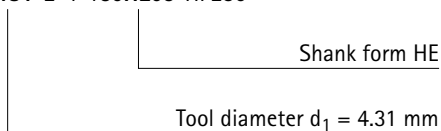

Dimensions in mm.

For cutting data recommendations, see end of chapter.

Special designs and other coatings available upon request.

ECU-Drill-Steel

Solid carbide twist drill
SCD361 (3xD), internal coolant supply

Design:
 Drill diameter: 3.00 - 20.00 mm
 Bore tolerance: \geq IT 9
 Cutting material: HP132
 Number of cutting edges: 2
 Tip angle: 140°
 Helix angle: 30°

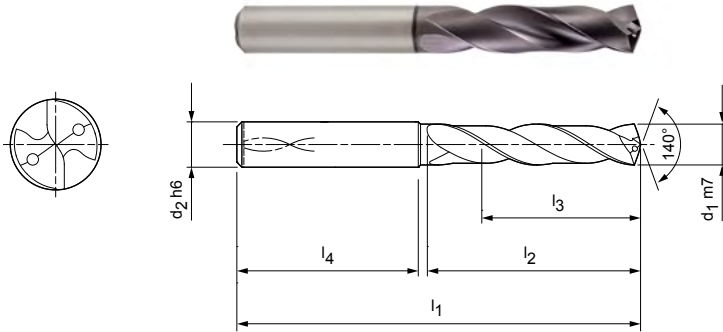

Stocked preferred series in shank form HA

Dimensions						Shank form HA	
d ₁ m7	d ₂ h6	l ₁	l ₂	l ₃	l ₄	Specification	Order no.
3,00	6	62	20	14	36	SCD361-0300-2-2-140HA03-HP132	30421364
3,10	6	62	20	14	36	SCD361-0310-2-2-140HA03-HP132	30421365
3,20	6	62	20	14	36	SCD361-0320-2-2-140HA03-HP132	30421366
3,30	6	62	20	14	36	SCD361-0330-2-2-140HA03-HP132	30421368
3,40	6	62	20	14	36	SCD361-0340-2-2-140HA03-HP132	30421369
3,50	6	62	20	14	36	SCD361-0350-2-2-140HA03-HP132	30421370
3,70*	6	62	20	14	36	SCD361-0370-2-2-140HA03-HP132	30421372
3,80	6	66	24	17	36	SCD361-0380-2-2-140HA03-HP132	30421373
3,90	6	66	24	17	36	SCD361-0390-2-2-140HA03-HP132	30421374
4,00	6	66	24	17	36	SCD361-0400-2-2-140HA03-HP132	30421375
4,10	6	66	24	17	36	SCD361-0410-2-2-140HA03-HP132	30421376
4,20	6	66	24	17	36	SCD361-0420-2-2-140HA03-HP132	30421377
4,30	6	66	24	17	36	SCD361-0430-2-2-140HA03-HP132	30421379
4,40	6	66	24	17	36	SCD361-0440-2-2-140HA03-HP132	30421380
4,50	6	66	24	17	36	SCD361-0450-2-2-140HA03-HP132	30421381
4,60	6	66	24	17	36	SCD361-0460-2-2-140HA03-HP132	30421382
4,65*	6	66	24	17	36	SCD361-0465-2-2-140HA03-HP132	30421383
4,70	6	66	24	17	36	SCD361-0470-2-2-140HA03-HP132	30421384
4,80	6	66	28	20	36	SCD361-0480-2-2-140HA03-HP132	30421385
4,90	6	66	28	20	36	SCD361-0490-2-2-140HA03-HP132	30421386
5,00	6	66	28	20	36	SCD361-0500-2-2-140HA03-HP132	30421388
5,10	6	66	28	20	36	SCD361-0510-2-2-140HA03-HP132	30421390
5,20	6	66	28	20	36	SCD361-0520-2-2-140HA03-HP132	30421391
5,30	6	66	28	20	36	SCD361-0530-2-2-140HA03-HP132	30421392
5,40	6	66	28	20	36	SCD361-0540-2-2-140HA03-HP132	30421393
5,50	6	66	28	20	36	SCD361-0550-2-2-140HA03-HP132	30421394
5,55*	6	66	28	20	36	SCD361-0555-2-2-140HA03-HP132	30421395
5,60	6	66	28	20	36	SCD361-0560-2-2-140HA03-HP132	30421396
5,80	6	66	28	20	36	SCD361-0580-2-2-140HA03-HP132	30421399
5,90	6	66	28	20	36	SCD361-0590-2-2-140HA03-HP132	30421400
6,00	6	66	28	20	36	SCD361-0600-2-2-140HA03-HP132	30421401
6,10	8	79	34	24	36	SCD361-0610-2-2-140HA03-HP132	30421402
6,20	8	79	34	24	36	SCD361-0620-2-2-140HA03-HP132	30421403
6,30	8	79	34	24	36	SCD361-0630-2-2-140HA03-HP132	30421404
6,40	8	79	34	24	36	SCD361-0640-2-2-140HA03-HP132	30421405

ECU-Drill-Steel | Solid carbide twist drill SCD361 (3xD), internal coolant supply

Dimensions						Shank form HA	
d ₁ m7	d ₂ h6	l ₁	l ₂	l ₃	l ₄	Specification	Order no.
6,50	8	79	34	24	36	SCD361-0650-2-2-140HA03-HP132	30421406
6,60	8	79	34	24	36	SCD361-0660-2-2-140HA03-HP132	30421407
6,70	8	79	34	24	36	SCD361-0670-2-2-140HA03-HP132	30421408
6,80	8	79	34	24	36	SCD361-0680-2-2-140HA03-HP132	30421409
6,90	8	79	34	24	36	SCD361-0690-2-2-140HA03-HP132	30421410
7,00	8	79	34	24	36	SCD361-0700-2-2-140HA03-HP132	30421411
7,10	8	79	41	29	36	SCD361-0710-2-2-140HA03-HP132	30421412
7,20	8	79	41	29	36	SCD361-0720-2-2-140HA03-HP132	30421413
7,40	8	79	41	29	36	SCD361-0740-2-2-140HA03-HP132	30421415
7,45*	8	79	41	29	36	SCD361-0745-2-2-140HA03-HP132	30421416
7,50	8	79	41	29	36	SCD361-0750-2-2-140HA03-HP132	30421417
7,70	8	79	41	29	36	SCD361-0770-2-2-140HA03-HP132	30421420
7,80	8	79	41	29	36	SCD361-0780-2-2-140HA03-HP132	30421421
7,90	8	79	41	29	36	SCD361-0790-2-2-140HA03-HP132	30421422
8,00	8	79	41	29	36	SCD361-0800-2-2-140HA03-HP132	30421423
8,10	10	89	47	35	40	SCD361-0810-2-2-140HA03-HP132	30421424
8,20	10	89	47	35	40	SCD361-0820-2-2-140HA03-HP132	30421425
8,30	10	89	47	35	40	SCD361-0830-2-2-140HA03-HP132	30421426
8,40	10	89	47	35	40	SCD361-0840-2-2-140HA03-HP132	30421427
8,50	10	89	47	35	40	SCD361-0850-2-2-140HA03-HP132	30421428
8,60	10	89	47	35	40	SCD361-0860-2-2-140HA03-HP132	30421429
8,70	10	89	47	35	40	SCD361-0870-2-2-140HA03-HP132	30421430
8,80	10	89	47	35	40	SCD361-0880-2-2-140HA03-HP132	30421431
8,90	10	89	47	35	40	SCD361-0890-2-2-140HA03-HP132	30421432
9,00	10	89	47	35	40	SCD361-0900-2-2-140HA03-HP132	30421433
9,10	10	89	47	35	40	SCD361-0910-2-2-140HA03-HP132	30421434
9,20	10	89	47	35	40	SCD361-0920-2-2-140HA03-HP132	30421435
9,30*	10	89	47	35	40	SCD361-0930-2-2-140HA03-HP132	30421437
9,35	10	89	47	35	40	SCD361-0935-2-2-140HA03-HP132	30421438
9,40	10	89	47	35	40	SCD361-0940-2-2-140HA03-HP132	30421439
9,50	10	89	47	35	40	SCD361-0950-2-2-140HA03-HP132	30421440
9,60	10	89	47	35	40	SCD361-0960-2-2-140HA03-HP132	30421441
9,80	10	89	47	35	40	SCD361-0980-2-2-140HA03-HP132	30421443
9,90	10	89	47	35	40	SCD361-0990-2-2-140HA03-HP132	30421445
10,00	10	89	47	35	40	SCD361-1000-2-2-140HA03-HP132	30421446
10,10	12	102	55	40	45	SCD361-1010-2-2-140HA03-HP132	30421447
10,20	12	102	55	40	45	SCD361-1020-2-2-140HA03-HP132	30421448
10,30	12	102	55	40	45	SCD361-1030-2-2-140HA03-HP132	30421449
10,40	12	102	55	40	45	SCD361-1040-2-2-140HA03-HP132	30421450
10,50	12	102	55	40	45	SCD361-1050-2-2-140HA03-HP132	30421451
10,60	12	102	55	40	45	SCD361-1060-2-2-140HA03-HP132	30421453
10,70	12	102	55	40	45	SCD361-1070-2-2-140HA03-HP132	30421454
10,80	12	102	55	40	45	SCD361-1080-2-2-140HA03-HP132	30421456
10,90	12	102	55	40	45	SCD361-1090-2-2-140HA03-HP132	30421457
11,00	12	102	55	40	45	SCD361-1100-2-2-140HA03-HP132	30421458
11,10	12	102	55	40	45	SCD361-1110-2-2-140HA03-HP132	30421459
11,20*	12	102	55	40	45	SCD361-1120-2-2-140HA03-HP132	30421460
11,40	12	102	55	40	45	SCD361-1140-2-2-140HA03-HP132	30421463
11,50	12	102	55	40	45	SCD361-1150-2-2-140HA03-HP132	30421464
11,70	12	102	55	40	45	SCD361-1170-2-2-140HA03-HP132	30421466
11,80	12	102	55	40	45	SCD361-1180-2-2-140HA03-HP132	30421467
12,00	12	102	55	40	45	SCD361-1200-2-2-140HA03-HP132	30421469
12,25	14	107	60	43	45	SCD361-1225-2-2-140HA03-HP132	30421470
12,50	14	107	60	43	45	SCD361-1250-2-2-140HA03-HP132	30421471
12,70	14	107	60	43	45	SCD361-1270-2-2-140HA03-HP132	30421472
12,80	14	107	60	43	45	SCD361-1280-2-2-140HA03-HP132	30421473
12,90	14	107	60	43	45	SCD361-1290-2-2-140HA03-HP132	30421474

ECU-Drill-Steel | Solid carbide twist drill SCD361 (3xD), internal coolant supply

Dimensions						Shank form HA	
d ₁ m7	d ₂ h6	l ₁	l ₂	l ₃	l ₄	Specification	Order no.
13,00	14	107	60	43	45	SCD361-1300-2-2-140HA03-HP132	30421475
13,10	14	107	60	43	45	SCD361-1310-2-2-140HA03-HP132	30421476
13,20	14	107	60	43	45	SCD361-1320-2-2-140HA03-HP132	30421477
13,50	14	107	60	43	45	SCD361-1350-2-2-140HA03-HP132	30421479
13,80	14	107	60	43	45	SCD361-1380-2-2-140HA03-HP132	30421481
14,00	14	107	60	43	45	SCD361-1400-2-2-140HA03-HP132	30421482
14,20	16	115	65	45	48	SCD361-1420-2-2-140HA03-HP132	30421483
14,50	16	115	65	45	48	SCD361-1450-2-2-140HA03-HP132	30421484
14,80	16	115	65	45	48	SCD361-1480-2-2-140HA03-HP132	30421487
15,00	16	115	65	45	48	SCD361-1500-2-2-140HA03-HP132	30421488
15,10	16	115	65	45	48	SCD361-1510-2-2-140HA03-HP132	30421489
15,25	16	115	65	45	48	SCD361-1525-2-2-140HA03-HP132	30421490
15,30	16	115	65	45	48	SCD361-1530-2-2-140HA03-HP132	30421491
15,50	16	115	65	45	48	SCD361-1550-2-2-140HA03-HP132	30421493
15,80	16	115	65	45	48	SCD361-1580-2-2-140HA03-HP132	30421496
16,00	16	115	65	45	48	SCD361-1600-2-2-140HA03-HP132	30421497
16,50	18	123	73	51	48	SCD361-1650-2-2-140HA03-HP132	30421498
16,80	18	123	73	51	48	SCD361-1680-2-2-140HA03-HP132	30421499
17,00	18	123	73	51	48	SCD361-1700-2-2-140HA03-HP132	30421501
17,50	18	123	73	51	48	SCD361-1750-2-2-140HA03-HP132	30421502
17,80	18	123	73	51	48	SCD361-1780-2-2-140HA03-HP132	30421504
18,00	18	123	73	51	48	SCD361-1800-2-2-140HA03-HP132	30421505
18,50	20	131	79	55	50	SCD361-1850-2-2-140HA03-HP132	30421506
19,00	20	131	79	55	50	SCD361-1900-2-2-140HA03-HP132	30421509
19,80	20	131	79	55	50	SCD361-1980-2-2-140HA03-HP132	30421512
20,00	20	131	79	55	50	SCD361-2000-2-2-140HA03-HP132	30421513

Configurable features



Shank form:
Shank form: HB | HE



Specification:
SCD361-0430-2-2-140[shank form]03-HP132

Example:
SCD361-0430-2-2-140HE03-HP132

Shank form HE

Dimensions in mm.

* Particularly suitable for the premanufacturing of core bores for thread formers.

For cutting data recommendations, see end of chapter.

Special designs and other coatings available upon request.

ECU-Drill-Steel

Solid carbide twist drill
SCD360 (3xD), external coolant supply

Design:

Drill diameter: 3.00 - 20.00 mm
Bore tolerance: \geq IT 9
Cutting material: HP132
Number of cutting edges: 2
Tip angle: 140°
Helix angle: 30°

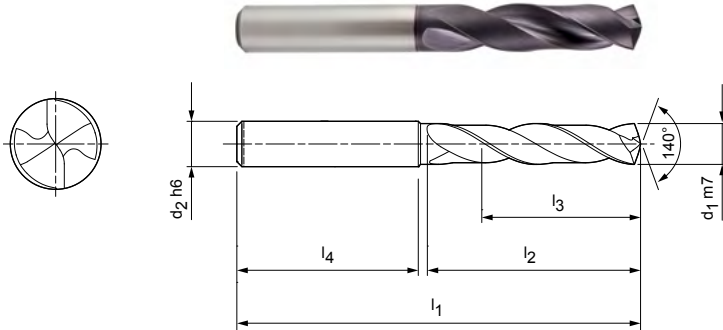

Stocked preferred series in shank form HA

Dimensions						Shank form HA	
d ₁ m7	d ₂ h6	l ₁	l ₂	l ₃	l ₄	Specification	Order no.
3,00	6	62	20	14	36	SCD360-0300-2-2-140HA03-HP132	30421215
3,10	6	62	20	14	36	SCD360-0310-2-2-140HA03-HP132	30421216
3,20	6	62	20	14	36	SCD360-0320-2-2-140HA03-HP132	30421217
3,30	6	62	20	14	36	SCD360-0330-2-2-140HA03-HP132	30421218
3,40	6	62	20	14	36	SCD360-0340-2-2-140HA03-HP132	30421219
3,50	6	62	20	14	36	SCD360-0350-2-2-140HA03-HP132	30421220
3,60	6	62	20	14	36	SCD360-0360-2-2-140HA03-HP132	30421221
3,70*	6	62	20	14	36	SCD360-0370-2-2-140HA03-HP132	30421222
3,80	6	66	24	17	36	SCD360-0380-2-2-140HA03-HP132	30421223
3,90	6	66	24	17	36	SCD360-0390-2-2-140HA03-HP132	30421224
4,00	6	66	24	17	36	SCD360-0400-2-2-140HA03-HP132	30421225
4,02	6	66	24	17	36	SCD360-0402-2-2-140HA03-HP132	30421226
4,10	6	66	24	17	36	SCD360-0410-2-2-140HA03-HP132	30421227
4,20	6	66	24	17	36	SCD360-0420-2-2-140HA03-HP132	30421228
4,30	6	66	24	17	36	SCD360-0430-2-2-140HA03-HP132	30421229
4,40	6	66	24	17	36	SCD360-0440-2-2-140HA03-HP132	30421230
4,50	6	66	24	17	36	SCD360-0450-2-2-140HA03-HP132	30421231
4,60	6	66	24	17	36	SCD360-0460-2-2-140HA03-HP132	30421232
4,65*	6	66	24	17	36	SCD360-0465-2-2-140HA03-HP132	30421233
4,70	6	66	24	17	36	SCD360-0470-2-2-140HA03-HP132	30421234
4,80	6	66	28	20	36	SCD360-0480-2-2-140HA03-HP132	30421235
4,90	6	66	28	20	36	SCD360-0490-2-2-140HA03-HP132	30421236
5,00	6	66	28	20	36	SCD360-0500-2-2-140HA03-HP132	30421237
5,10	6	66	28	20	36	SCD360-0510-2-2-140HA03-HP132	30421238
5,20	6	66	28	20	36	SCD360-0520-2-2-140HA03-HP132	30421240
5,30	6	66	28	20	36	SCD360-0530-2-2-140HA03-HP132	30421241
5,40	6	66	28	20	36	SCD360-0540-2-2-140HA03-HP132	30421242
5,50	6	66	28	20	36	SCD360-0550-2-2-140HA03-HP132	30421243
5,55*	6	66	28	20	36	SCD360-0555-2-2-140HA03-HP132	30421244
5,60	6	66	28	20	36	SCD360-0560-2-2-140HA03-HP132	30421245
5,70	6	66	28	20	36	SCD360-0570-2-2-140HA03-HP132	30421246
5,80	6	66	28	20	36	SCD360-0580-2-2-140HA03-HP132	30421247
5,90	6	66	28	20	36	SCD360-0590-2-2-140HA03-HP132	30421248
6,00	6	66	28	20	36	SCD360-0600-2-2-140HA03-HP132	30421249
6,10	8	79	34	24	36	SCD360-0610-2-2-140HA03-HP132	30421250

ECU-Drill-Steel | Solid carbide twist drill SCD360 (3xD), external coolant supply

Dimensions						Shank form HA	
d ₁ m7	d ₂ h6	l ₁	l ₂	l ₃	l ₄	Specification	Order no.
6,20	8	79	34	24	36	SCD360-0620-2-2-140HA03-HP132	30421251
6,30	8	79	34	24	36	SCD360-0630-2-2-140HA03-HP132	30421252
6,40	8	79	34	24	36	SCD360-0640-2-2-140HA03-HP132	30421253
6,50	8	79	34	24	36	SCD360-0650-2-2-140HA03-HP132	30421254
6,60	8	79	34	24	36	SCD360-0660-2-2-140HA03-HP132	30421255
6,70	8	79	34	24	36	SCD360-0670-2-2-140HA03-HP132	30421256
6,80	8	79	34	24	36	SCD360-0680-2-2-140HA03-HP132	30421257
6,90	8	79	34	24	36	SCD360-0690-2-2-140HA03-HP132	30421258
7,00	8	79	34	24	36	SCD360-0700-2-2-140HA03-HP132	30421259
7,10	8	79	41	29	36	SCD360-0710-2-2-140HA03-HP132	30421260
7,20	8	79	41	29	36	SCD360-0720-2-2-140HA03-HP132	30421261
7,30	8	79	41	29	36	SCD360-0730-2-2-140HA03-HP132	30421262
7,40	8	79	41	29	36	SCD360-0740-2-2-140HA03-HP132	30421263
7,50	8	79	41	29	36	SCD360-0750-2-2-140HA03-HP132	30421264
7,60	8	79	41	29	36	SCD360-0760-2-2-140HA03-HP132	30421266
7,70	8	79	41	29	36	SCD360-0770-2-2-140HA03-HP132	30421267
7,80	8	79	41	29	36	SCD360-0780-2-2-140HA03-HP132	30421268
7,90	8	79	41	29	36	SCD360-0790-2-2-140HA03-HP132	30421269
8,00	8	79	41	29	36	SCD360-0800-2-2-140HA03-HP132	30421270
8,10	10	89	47	35	40	SCD360-0810-2-2-140HA03-HP132	30421271
8,20	10	89	47	35	40	SCD360-0820-2-2-140HA03-HP132	30421272
8,30	10	89	47	35	40	SCD360-0830-2-2-140HA03-HP132	30421273
8,40	10	89	47	35	40	SCD360-0840-2-2-140HA03-HP132	30421274
8,50	10	89	47	35	40	SCD360-0850-2-2-140HA03-HP132	30421275
8,60	10	89	47	35	40	SCD360-0860-2-2-140HA03-HP132	30421276
8,70	10	89	47	35	40	SCD360-0870-2-2-140HA03-HP132	30421277
8,80	10	89	47	35	40	SCD360-0880-2-2-140HA03-HP132	30421278
8,90	10	89	47	35	40	SCD360-0890-2-2-140HA03-HP132	30421279
9,00	10	89	47	35	40	SCD360-0900-2-2-140HA03-HP132	30421280
9,10	10	89	47	35	40	SCD360-0910-2-2-140HA03-HP132	30421281
9,20	10	89	47	35	40	SCD360-0920-2-2-140HA03-HP132	30421282
9,30*	10	89	47	35	40	SCD360-0930-2-2-140HA03-HP132	30421284
9,40	10	89	47	35	40	SCD360-0940-2-2-140HA03-HP132	30421285
9,50	10	89	47	35	40	SCD360-0950-2-2-140HA03-HP132	30421286
9,60	10	89	47	35	40	SCD360-0960-2-2-140HA03-HP132	30421287
9,70	10	89	47	35	40	SCD360-0970-2-2-140HA03-HP132	30421288
9,80	10	89	47	35	40	SCD360-0980-2-2-140HA03-HP132	30421289
9,90	10	89	47	35	40	SCD360-0990-2-2-140HA03-HP132	30421290
10,00	10	89	47	35	40	SCD360-1000-2-2-140HA03-HP132	30421291
10,10	12	102	55	40	45	SCD360-1010-2-2-140HA03-HP132	30421292
10,20	12	102	55	40	45	SCD360-1020-2-2-140HA03-HP132	30421293
10,30	12	102	55	40	45	SCD360-1030-2-2-140HA03-HP132	30421294
10,40	12	102	55	40	45	SCD360-1040-2-2-140HA03-HP132	30421295
10,50	12	102	55	40	45	SCD360-1050-2-2-140HA03-HP132	30421296
10,60	12	102	55	40	45	SCD360-1060-2-2-140HA03-HP132	30421297
10,70	12	102	55	40	45	SCD360-1070-2-2-140HA03-HP132	30421298
10,80	12	102	55	40	45	SCD360-1080-2-2-140HA03-HP132	30421300
10,90	12	102	55	40	45	SCD360-1090-2-2-140HA03-HP132	30421301
11,00	12	102	55	40	45	SCD360-1100-2-2-140HA03-HP132	30421302
11,10	12	102	55	40	45	SCD360-1110-2-2-140HA03-HP132	30421303
11,20*	12	102	55	40	45	SCD360-1120-2-2-140HA03-HP132	30421304
11,30	12	102	55	40	45	SCD360-1130-2-2-140HA03-HP132	30421305
11,40	12	102	55	40	45	SCD360-1140-2-2-140HA03-HP132	30421306
11,50	12	102	55	40	45	SCD360-1150-2-2-140HA03-HP132	30421307
11,60	12	102	55	40	45	SCD360-1160-2-2-140HA03-HP132	30421308
11,70	12	102	55	40	45	SCD360-1170-2-2-140HA03-HP132	30421309
11,80	12	102	55	40	45	SCD360-1180-2-2-140HA03-HP132	30421310

Continued on next page.

ECU-Drill-Steel | Solid carbide twist drill SCD360 (3xD), external coolant supply

Dimensions						Shank form HA	
d ₁ m7	d ₂ h6	l ₁	l ₂	l ₃	l ₄	Specification	Order no.
11,90	12	102	55	40	45	SCD360-1190-2-2-140HA03-HP132	30421312
12,00	12	102	55	40	45	SCD360-1200-2-2-140HA03-HP132	30421313
12,20	14	107	60	43	45	SCD360-1220-2-2-140HA03-HP132	30569112
12,25	14	107	60	43	45	SCD360-1225-2-2-140HA03-HP132	30421314
12,50	14	107	60	43	45	SCD360-1250-2-2-140HA03-HP132	30421316
12,70	14	107	60	43	45	SCD360-1270-2-2-140HA03-HP132	30421317
12,80	14	107	60	43	45	SCD360-1280-2-2-140HA03-HP132	30421318
13,00	14	107	60	43	45	SCD360-1300-2-2-140HA03-HP132	30421320
13,30	14	107	60	43	45	SCD360-1330-2-2-140HA03-HP132	30421323
13,50	14	107	60	43	45	SCD360-1350-2-2-140HA03-HP132	30421324
13,70	14	107	60	43	45	SCD360-1370-2-2-140HA03-HP132	30421325
13,80	14	107	60	43	45	SCD360-1380-2-2-140HA03-HP132	30421326
14,00	14	107	60	43	45	SCD360-1400-2-2-140HA03-HP132	30421327
14,20	16	115	65	45	48	SCD360-1420-2-2-140HA03-HP132	30421328
14,50	16	115	65	45	48	SCD360-1450-2-2-140HA03-HP132	30421330
14,70	16	115	65	45	48	SCD360-1470-2-2-140HA03-HP132	30421331
15,00	16	115	65	45	48	SCD360-1500-2-2-140HA03-HP132	30421333
15,25	16	115	65	45	48	SCD360-1525-2-2-140HA03-HP132	30421335
15,30	16	115	65	45	48	SCD360-1530-2-2-140HA03-HP132	30421336
15,50	16	115	65	45	48	SCD360-1550-2-2-140HA03-HP132	30421337
15,80	16	115	65	45	48	SCD360-1580-2-2-140HA03-HP132	30421339
16,00	16	115	65	45	48	SCD360-1600-2-2-140HA03-HP132	30421340
16,50	18	123	73	51	48	SCD360-1650-2-2-140HA03-HP132	30421341
16,80	18	123	73	51	48	SCD360-1680-2-2-140HA03-HP132	30421342
17,00	18	123	73	51	48	SCD360-1700-2-2-140HA03-HP132	30421343
17,50	18	123	73	51	48	SCD360-1750-2-2-140HA03-HP132	30421344
17,80	18	123	73	51	48	SCD360-1780-2-2-140HA03-HP132	30421345
18,00	18	123	73	51	48	SCD360-1800-2-2-140HA03-HP132	30421346
18,50	20	131	79	55	50	SCD360-1850-2-2-140HA03-HP132	30421347
19,00	20	131	79	55	50	SCD360-1900-2-2-140HA03-HP132	30421349
19,50	20	131	79	55	50	SCD360-1950-2-2-140HA03-HP132	30421350
19,80	20	131	79	55	50	SCD360-1980-2-2-140HA03-HP132	30421351
20,00	20	131	79	55	50	SCD360-2000-2-2-140HA03-HP132	30421352

Configurable features



Shank form:
Shank form: HB | HE



Specification:
SCD360-0430-2-2-140[shank form]05-HP132

Example:

SCD360-0430-2-2-140HE05-HP132

Shank form HE

Dimensions in mm.

* Particularly suitable for the premanufacturing of core bores for thread formers.

For cutting data recommendations, see end of chapter.

Special designs and other coatings available upon request.

ECU-Drill-Steel

Solid carbide twist drill
SCD361 (5xD), internal coolant supply

Design:
 Drill diameter: 3.00 - 20.00 mm
 Bore tolerance: \geq IT 9
 Cutting material: HP132
 Number of cutting edges: 2
 Tip angle: 140°
 Helix angle: 30°

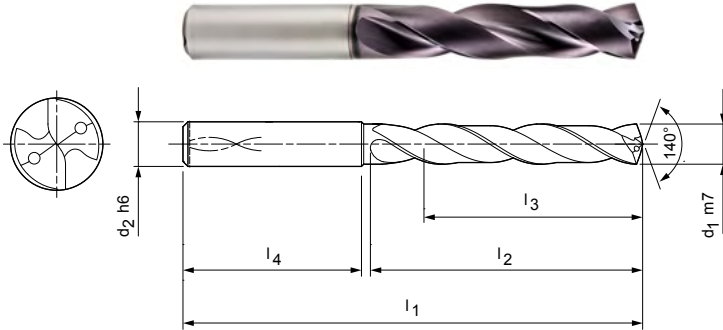

Stocked preferred series in shank form HA

Dimensions						Shank form HA	
d ₁ m7	d ₂ h6	l ₁	l ₂	l ₃	l ₄	Specification	Order no.
3,00	6	66	28	23	36	SCD361-0300-2-2-140HA05-HP132	30421524
3,10	6	66	28	23	36	SCD361-0310-2-2-140HA05-HP132	30421525
3,20	6	66	28	23	36	SCD361-0320-2-2-140HA05-HP132	30421526
3,30	6	66	28	23	36	SCD361-0330-2-2-140HA05-HP132	30421528
3,40	6	66	28	23	36	SCD361-0340-2-2-140HA05-HP132	30421529
3,50	6	66	28	23	36	SCD361-0350-2-2-140HA05-HP132	30421530
3,60	6	66	28	23	36	SCD361-0360-2-2-140HA05-HP132	30421531
3,70*	6	66	28	23	36	SCD361-0370-2-2-140HA05-HP132	30421532
3,80	6	74	36	29	36	SCD361-0380-2-2-140HA05-HP132	30421533
3,90	6	74	36	29	36	SCD361-0390-2-2-140HA05-HP132	30421534
4,00	6	74	36	29	36	SCD361-0400-2-2-140HA05-HP132	30421535
4,10	6	74	36	29	36	SCD361-0410-2-2-140HA05-HP132	30421536
4,20	6	74	36	29	36	SCD361-0420-2-2-140HA05-HP132	30421537
4,30	6	74	36	29	36	SCD361-0430-2-2-140HA05-HP132	30421539
4,40	6	74	36	29	36	SCD361-0440-2-2-140HA05-HP132	30421540
4,50	6	74	36	29	36	SCD361-0450-2-2-140HA05-HP132	30421541
4,60	6	74	36	29	36	SCD361-0460-2-2-140HA05-HP132	30421542
4,65*	6	74	36	29	36	SCD361-0465-2-2-140HA05-HP132	30421543
4,70	6	74	36	29	36	SCD361-0470-2-2-140HA05-HP132	30421544
4,80	6	82	44	35	36	SCD361-0480-2-2-140HA05-HP132	30421545
4,90	6	82	44	35	36	SCD361-0490-2-2-140HA05-HP132	30421546
5,00	6	82	44	35	36	SCD361-0500-2-2-140HA05-HP132	30421548
5,10	6	82	44	35	36	SCD361-0510-2-2-140HA05-HP132	30421550
5,20	6	82	44	35	36	SCD361-0520-2-2-140HA05-HP132	30421551
5,30	6	82	44	35	36	SCD361-0530-2-2-140HA05-HP132	30421552
5,40	6	82	44	35	36	SCD361-0540-2-2-140HA05-HP132	30421553
5,50	6	82	44	35	36	SCD361-0550-2-2-140HA05-HP132	30421554
5,55*	6	82	44	35	36	SCD361-0555-2-2-140HA05-HP132	30421555
5,60	6	82	44	35	36	SCD361-0560-2-2-140HA05-HP132	30421556
5,70	6	82	44	35	36	SCD361-0570-2-2-140HA05-HP132	30421557
5,80	6	82	44	35	36	SCD361-0580-2-2-140HA05-HP132	30421559
5,90	6	82	44	35	36	SCD361-0590-2-2-140HA05-HP132	30421560
6,00	6	82	44	35	36	SCD361-0600-2-2-140HA05-HP132	30421561
6,10	8	91	53	43	36	SCD361-0610-2-2-140HA05-HP132	30421562
6,20	8	91	53	43	36	SCD361-0620-2-2-140HA05-HP132	30421563

ECU-Drill-Steel | Solid carbide twist drill SCD361 (5xD), internal coolant supply

Dimensions						Shank form HA	
d ₁ m7	d ₂ h6	l ₁	l ₂	l ₃	l ₄	Specification	Order no.
6,30	8	91	53	43	36	SCD361-0630-2-2-140HA05-HP132	30421564
6,40	8	91	53	43	36	SCD361-0640-2-2-140HA05-HP132	30421565
6,50	8	91	53	43	36	SCD361-0650-2-2-140HA05-HP132	30421566
6,60	8	91	53	43	36	SCD361-0660-2-2-140HA05-HP132	30421567
6,70	8	91	53	43	36	SCD361-0670-2-2-140HA05-HP132	30421568
6,80	8	91	53	43	36	SCD361-0680-2-2-140HA05-HP132	30421569
6,90	8	91	53	43	36	SCD361-0690-2-2-140HA05-HP132	30421570
7,00	8	91	53	43	36	SCD361-0700-2-2-140HA05-HP132	30421571
7,10	8	91	53	43	36	SCD361-0710-2-2-140HA05-HP132	30421572
7,20	8	91	53	43	36	SCD361-0720-2-2-140HA05-HP132	30421573
7,30	8	91	53	43	36	SCD361-0730-2-2-140HA05-HP132	30421574
7,40	8	91	53	43	36	SCD361-0740-2-2-140HA05-HP132	30421575
7,45*	8	91	53	43	36	SCD361-0745-2-2-140HA05-HP132	30421576
7,50	8	91	53	43	36	SCD361-0750-2-2-140HA05-HP132	30421577
7,60	8	91	53	43	36	SCD361-0760-2-2-140HA05-HP132	30421579
7,70	8	91	53	43	36	SCD361-0770-2-2-140HA05-HP132	30421580
7,80	8	91	53	43	36	SCD361-0780-2-2-140HA05-HP132	30421581
7,90	8	91	53	43	36	SCD361-0790-2-2-140HA05-HP132	30421582
8,00	8	91	53	43	36	SCD361-0800-2-2-140HA05-HP132	30421583
8,10	10	103	61	49	40	SCD361-0810-2-2-140HA05-HP132	30421584
8,20	10	103	61	49	40	SCD361-0820-2-2-140HA05-HP132	30421585
8,30	10	103	61	49	40	SCD361-0830-2-2-140HA05-HP132	30421586
8,40	10	103	61	49	40	SCD361-0840-2-2-140HA05-HP132	30421587
8,50	10	103	61	49	40	SCD361-0850-2-2-140HA05-HP132	30421588
8,60	10	103	61	49	40	SCD361-0860-2-2-140HA05-HP132	30421589
8,70	10	103	61	49	40	SCD361-0870-2-2-140HA05-HP132	30421590
8,80	10	103	61	49	40	SCD361-0880-2-2-140HA05-HP132	30421591
8,90	10	103	61	49	40	SCD361-0890-2-2-140HA05-HP132	30421592
9,00	10	103	61	49	40	SCD361-0900-2-2-140HA05-HP132	30421593
9,10	10	103	61	49	40	SCD361-0910-2-2-140HA05-HP132	30421594
9,20	10	103	61	49	40	SCD361-0920-2-2-140HA05-HP132	30421595
9,30*	10	103	61	49	40	SCD361-0930-2-2-140HA05-HP132	30421597
9,35	10	103	61	49	40	SCD361-0935-2-2-140HA05-HP132	30421598
9,40	10	103	61	49	40	SCD361-0940-2-2-140HA05-HP132	30421599
9,50	10	103	61	49	40	SCD361-0950-2-2-140HA05-HP132	30421600
9,60	10	103	61	49	40	SCD361-0960-2-2-140HA05-HP132	30421601
9,70	10	103	61	49	40	SCD361-0970-2-2-140HA05-HP132	30421602
9,80	10	103	61	49	40	SCD361-0980-2-2-140HA05-HP132	30421603
9,90	10	103	61	49	40	SCD361-0990-2-2-140HA05-HP132	30421604
10,00	10	103	61	49	40	SCD361-1000-2-2-140HA05-HP132	30421605
10,10	12	118	71	56	45	SCD361-1010-2-2-140HA05-HP132	30421606
10,20	12	118	71	56	45	SCD361-1020-2-2-140HA05-HP132	30421607
10,30	12	118	71	56	45	SCD361-1030-2-2-140HA05-HP132	30421608
10,40	12	118	71	56	45	SCD361-1040-2-2-140HA05-HP132	30421609
10,50	12	118	71	56	45	SCD361-1050-2-2-140HA05-HP132	30421610
10,60	12	118	71	56	45	SCD361-1060-2-2-140HA05-HP132	30421612
10,70	12	118	71	56	45	SCD361-1070-2-2-140HA05-HP132	30421613
10,80	12	118	71	56	45	SCD361-1080-2-2-140HA05-HP132	30421615
10,90	12	118	71	56	45	SCD361-1090-2-2-140HA05-HP132	30421616
11,00	12	118	71	56	45	SCD361-1100-2-2-140HA05-HP132	30421617
11,10	12	118	71	56	45	SCD361-1110-2-2-140HA05-HP132	30421618
11,20*	12	118	71	56	45	SCD361-1120-2-2-140HA05-HP132	30421619
11,25	12	118	71	56	45	SCD361-1125-2-2-140HA05-HP132	30421620
11,30	12	118	71	56	45	SCD361-1130-2-2-140HA05-HP132	30421621
11,40	12	118	71	56	45	SCD361-1140-2-2-140HA05-HP132	30421622
11,50	12	118	71	56	45	SCD361-1150-2-2-140HA05-HP132	30421623
11,60	12	118	71	56	45	SCD361-1160-2-2-140HA05-HP132	30421624

ECU-Drill-Steel | Solid carbide twist drill SCD361 (5xD), internal coolant supply

Dimensions						Shank form HA	
d ₁ m7	d ₂ h6	l ₁	l ₂	l ₃	l ₄	Specification	Order no.
11,70	12	118	71	56	45	SCD361-1170-2-2-140HA05-HP132	30421625
11,80	12	118	71	56	45	SCD361-1180-2-2-140HA05-HP132	30421626
11,90	12	118	71	56	45	SCD361-1190-2-2-140HA05-HP132	30421628
12,00	12	118	71	56	45	SCD361-1200-2-2-140HA05-HP132	30421629
12,20	14	124	77	60	45	SCD361-1220-2-2-140HA05-HP132	30569175
12,25	14	124	77	60	45	SCD361-1225-2-2-140HA05-HP132	30421630
12,50	14	124	77	60	45	SCD361-1250-2-2-140HA05-HP132	30421632
12,70	14	124	77	60	45	SCD361-1270-2-2-140HA05-HP132	30421633
12,80	14	124	77	60	45	SCD361-1280-2-2-140HA05-HP132	30421634
12,90	14	124	77	60	45	SCD361-1290-2-2-140HA05-HP132	30421635
13,00	14	124	77	60	45	SCD361-1300-2-2-140HA05-HP132	30421636
13,10	14	124	77	60	45	SCD361-1310-2-2-140HA05-HP132	30421637
13,20	14	124	77	60	45	SCD361-1320-2-2-140HA05-HP132	30421638
13,50	14	124	77	60	45	SCD361-1350-2-2-140HA05-HP132	30421640
13,70	14	124	77	60	45	SCD361-1370-2-2-140HA05-HP132	30421641
13,80	14	124	77	60	45	SCD361-1380-2-2-140HA05-HP132	30421642
14,00	14	124	77	60	45	SCD361-1400-2-2-140HA05-HP132	30421643
14,20	16	133	83	63	48	SCD361-1420-2-2-140HA05-HP132	30421644
14,50	16	133	83	63	48	SCD361-1450-2-2-140HA05-HP132	30421645
14,70	16	133	83	63	48	SCD361-1470-2-2-140HA05-HP132	30421646
14,80	16	133	83	63	48	SCD361-1480-2-2-140HA05-HP132	30421647
15,00	16	133	83	63	48	SCD361-1500-2-2-140HA05-HP132	30421648
15,10	16	133	83	63	48	SCD361-1510-2-2-140HA05-HP132	30421649
15,25	16	133	83	63	48	SCD361-1525-2-2-140HA05-HP132	30421650
15,30	16	133	83	63	48	SCD361-1530-2-2-140HA05-HP132	30421651
15,50	16	133	83	63	48	SCD361-1550-2-2-140HA05-HP132	30421652
15,70	16	133	83	63	48	SCD361-1570-2-2-140HA05-HP132	30421654
15,80	16	133	83	63	48	SCD361-1580-2-2-140HA05-HP132	30421655
16,00	16	133	83	63	48	SCD361-1600-2-2-140HA05-HP132	30421656
16,50	18	143	93	71	48	SCD361-1650-2-2-140HA05-HP132	30421657
16,80	18	143	93	71	48	SCD361-1680-2-2-140HA05-HP132	30421658
17,00	18	143	93	71	48	SCD361-1700-2-2-140HA05-HP132	30421660
17,50	18	143	93	71	48	SCD361-1750-2-2-140HA05-HP132	30421661
17,80	18	143	93	71	48	SCD361-1780-2-2-140HA05-HP132	30421663
18,00	18	143	93	71	48	SCD361-1800-2-2-140HA05-HP132	30421664
18,50	20	153	101	77	50	SCD361-1850-2-2-140HA05-HP132	30421665
18,80	20	153	101	77	50	SCD361-1880-2-2-140HA05-HP132	30421666
19,00	20	153	101	77	50	SCD361-1900-2-2-140HA05-HP132	30421668
19,50	20	153	101	77	50	SCD361-1950-2-2-140HA05-HP132	30421669
19,80	20	153	101	77	50	SCD361-1980-2-2-140HA05-HP132	30421671
20,00	20	153	101	77	50	SCD361-2000-2-2-140HA05-HP132	30421672

Continued on next page.

ECU-Drill-Steel | Solid carbide twist drill SCD361 (5xD), internal coolant supply

Configurable features

 **Shank form:**
Shank form: HB | HE

Specification:
SCD361-0430-2-2-140[shank form]05-HP132

Example:
SCD361-0430-2-2-140**HE**05-HP132

Shank form HE

Dimensions in mm.
* Particularly suitable for the premanufacturing of core bores for thread formers.
For cutting data recommendations, see end of chapter.
Special designs and other coatings available upon request.

ECU-Drill-Steel

Solid carbide twist drill
SCD360 (5xD), external coolant supply

Design:
 Drill diameter: 3.00 - 20.00 mm
 Bore tolerance: \geq IT 9
 Cutting material: HP132
 Number of cutting edges: 2
 Tip angle: 140°
 Helix angle: 30°

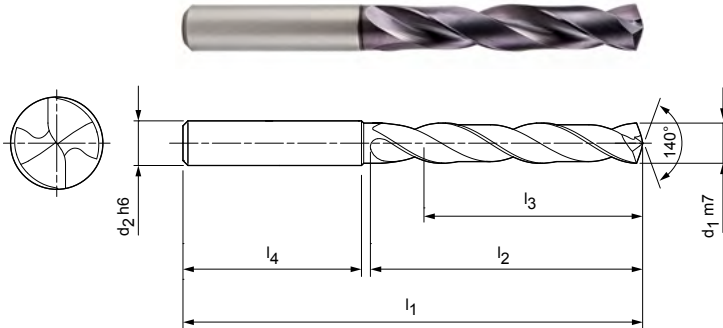

Stocked preferred series in shank form HA

Dimensions						Shank form HA	
d ₁ m7	d ₂ h6	l ₁	l ₂	l ₃	l ₄	Specification	Order no.
3,00	6	66	28	23	36	SCD360-0300-2-2-140HA05-HP132	30568692
3,10	6	66	28	23	36	SCD360-0310-2-2-140HA05-HP132	30568693
3,20	6	66	28	23	36	SCD360-0320-2-2-140HA05-HP132	30568694
3,30	6	66	28	23	36	SCD360-0330-2-2-140HA05-HP132	30568695
3,40	6	66	28	23	36	SCD360-0340-2-2-140HA05-HP132	30568696
3,50	6	66	28	23	36	SCD360-0350-2-2-140HA05-HP132	30568697
3,60	6	66	28	23	36	SCD360-0360-2-2-140HA05-HP132	30568698
3,70*	6	66	28	23	36	SCD360-0370-2-2-140HA05-HP132	30568699
3,80	6	74	36	29	36	SCD360-0380-2-2-140HA05-HP132	30568700
3,90	6	74	36	29	36	SCD360-0390-2-2-140HA05-HP132	30568701
4,00	6	74	36	29	36	SCD360-0400-2-2-140HA05-HP132	30568702
4,10	6	74	36	29	36	SCD360-0410-2-2-140HA05-HP132	30568703
4,20	6	74	36	29	36	SCD360-0420-2-2-140HA05-HP132	30568704
4,30	6	74	36	29	36	SCD360-0430-2-2-140HA05-HP132	30568705
4,40	6	74	36	29	36	SCD360-0440-2-2-140HA05-HP132	30568706
4,50	6	74	36	29	36	SCD360-0450-2-2-140HA05-HP132	30568707
4,60	6	74	36	29	36	SCD360-0460-2-2-140HA05-HP132	30568708
4,65*	6	74	36	29	36	SCD360-0465-2-2-140HA05-HP132	30568709
4,70	6	74	36	29	36	SCD360-0470-2-2-140HA05-HP132	30568710
4,80	6	82	44	35	36	SCD360-0480-2-2-140HA05-HP132	30568711
4,90	6	82	44	35	36	SCD360-0490-2-2-140HA05-HP132	30568712
5,00	6	82	44	35	36	SCD360-0500-2-2-140HA05-HP132	30568713
5,10	6	82	44	35	36	SCD360-0510-2-2-140HA05-HP132	30568714
5,20	6	82	44	35	36	SCD360-0520-2-2-140HA05-HP132	30568715
5,30	6	82	44	35	36	SCD360-0530-2-2-140HA05-HP132	30568716
5,40	6	82	44	35	36	SCD360-0540-2-2-140HA05-HP132	30568717
5,50	6	82	44	35	36	SCD360-0550-2-2-140HA05-HP132	30568718
5,55*	6	82	44	35	36	SCD360-0555-2-2-140HA05-HP132	30568719
5,60	6	82	44	35	36	SCD360-0560-2-2-140HA05-HP132	30568720
5,70	6	82	44	35	36	SCD360-0570-2-2-140HA05-HP132	30568721
5,80	6	82	44	35	36	SCD360-0580-2-2-140HA05-HP132	30568722
5,90	6	82	44	35	36	SCD360-0590-2-2-140HA05-HP132	30568723
6,00	6	82	44	35	36	SCD360-0600-2-2-140HA05-HP132	30568724
6,10	8	91	53	43	36	SCD360-0610-2-2-140HA05-HP132	30568725
6,20	8	91	53	43	36	SCD360-0620-2-2-140HA05-HP132	30568726

ECU-Drill-Steel | Solid carbide twist drill SCD360 (5xD), external coolant supply

Dimensions						Shank form HA	
d ₁ m7	d ₂ h6	l ₁	l ₂	l ₃	l ₄	Specification	Order no.
6,30	8	91	53	43	36	SCD360-0630-2-2-140HA05-HP132	30568727
6,40	8	91	53	43	36	SCD360-0640-2-2-140HA05-HP132	30568728
6,50	8	91	53	43	36	SCD360-0650-2-2-140HA05-HP132	30568729
6,60	8	91	53	43	36	SCD360-0660-2-2-140HA05-HP132	30568730
6,70	8	91	53	43	36	SCD360-0670-2-2-140HA05-HP132	30568731
6,80	8	91	53	43	36	SCD360-0680-2-2-140HA05-HP132	30568732
6,90	8	91	53	43	36	SCD360-0690-2-2-140HA05-HP132	30568733
7,00	8	91	53	43	36	SCD360-0700-2-2-140HA05-HP132	30568734
7,10	8	91	53	43	36	SCD360-0710-2-2-140HA05-HP132	30568735
7,20	8	91	53	43	36	SCD360-0720-2-2-140HA05-HP132	30568736
7,30	8	91	53	43	36	SCD360-0730-2-2-140HA05-HP132	30568737
7,40	8	91	53	43	36	SCD360-0740-2-2-140HA05-HP132	30568738
7,50	8	91	53	43	36	SCD360-0750-2-2-140HA05-HP132	30568740
7,60	8	91	53	43	36	SCD360-0760-2-2-140HA05-HP132	30568741
7,70	8	91	53	43	36	SCD360-0770-2-2-140HA05-HP132	30568742
7,80	8	91	53	43	36	SCD360-0780-2-2-140HA05-HP132	30568743
7,90	8	91	53	43	36	SCD360-0790-2-2-140HA05-HP132	30568744
8,00	8	91	53	43	36	SCD360-0800-2-2-140HA05-HP132	30568745
8,10	10	103	61	49	40	SCD360-0810-2-2-140HA05-HP132	30568746
8,20	10	103	61	49	40	SCD360-0820-2-2-140HA05-HP132	30568747
8,30	10	103	61	49	40	SCD360-0830-2-2-140HA05-HP132	30568748
8,40	10	103	61	49	40	SCD360-0840-2-2-140HA05-HP132	30568749
8,50	10	103	61	49	40	SCD360-0850-2-2-140HA05-HP132	30568750
8,60	10	103	61	49	40	SCD360-0860-2-2-140HA05-HP132	30568751
8,70	10	103	61	49	40	SCD360-0870-2-2-140HA05-HP132	30568752
8,80	10	103	61	49	40	SCD360-0880-2-2-140HA05-HP132	30568753
8,90	10	103	61	49	40	SCD360-0890-2-2-140HA05-HP132	30568754
9,00	10	103	61	49	40	SCD360-0900-2-2-140HA05-HP132	30568755
9,10	10	103	61	49	40	SCD360-0910-2-2-140HA05-HP132	30568756
9,20	10	103	61	49	40	SCD360-0920-2-2-140HA05-HP132	30568757
9,30*	10	103	61	49	40	SCD360-0930-2-2-140HA05-HP132	30568758
9,40	10	103	61	49	40	SCD360-0940-2-2-140HA05-HP132	30568759
9,50	10	103	61	49	40	SCD360-0950-2-2-140HA05-HP132	30568760
9,60	10	103	61	49	40	SCD360-0960-2-2-140HA05-HP132	30568761
9,70	10	103	61	49	40	SCD360-0970-2-2-140HA05-HP132	30568762
9,80	10	103	61	49	40	SCD360-0980-2-2-140HA05-HP132	30568763
9,90	10	103	61	49	40	SCD360-0990-2-2-140HA05-HP132	30568764
10,00	10	103	61	49	40	SCD360-1000-2-2-140HA05-HP132	30568765
10,10	12	118	71	56	45	SCD360-1010-2-2-140HA05-HP132	30568766
10,20	12	118	71	56	45	SCD360-1020-2-2-140HA05-HP132	30568767
10,30	12	118	71	56	45	SCD360-1030-2-2-140HA05-HP132	30568768
10,40	12	118	71	56	45	SCD360-1040-2-2-140HA05-HP132	30568769
10,50	12	118	71	56	45	SCD360-1050-2-2-140HA05-HP132	30568770
10,60	12	118	71	56	45	SCD360-1060-2-2-140HA05-HP132	30568771
10,80	12	118	71	56	45	SCD360-1080-2-2-140HA05-HP132	30568773
11,00	12	118	71	56	45	SCD360-1100-2-2-140HA05-HP132	30568775
11,10	12	118	71	56	45	SCD360-1110-2-2-140HA05-HP132	30568776
11,20*	12	118	71	56	45	SCD360-1120-2-2-140HA05-HP132	30568777
11,30	12	118	71	56	45	SCD360-1130-2-2-140HA05-HP132	30568778
11,40	12	118	71	56	45	SCD360-1140-2-2-140HA05-HP132	30568779
11,50	12	118	71	56	45	SCD360-1150-2-2-140HA05-HP132	30568780
11,60	12	118	71	56	45	SCD360-1160-2-2-140HA05-HP132	30568781
11,70	12	118	71	56	45	SCD360-1170-2-2-140HA05-HP132	30568782
11,80	12	118	71	56	45	SCD360-1180-2-2-140HA05-HP132	30568783
11,90	12	118	71	56	45	SCD360-1190-2-2-140HA05-HP132	30568784
12,00	12	118	71	56	45	SCD360-1200-2-2-140HA05-HP132	30568785
12,20	14	124	77	60	45	SCD360-1220-2-2-140HA05-HP132	30568786

ECU-Drill-Steel | Solid carbide twist drill SCD360 (5xD), external coolant supply

Dimensions						Shank form HA	
d ₁ m7	d ₂ h6	l ₁	l ₂	l ₃	l ₄	Specification	Order no.
12,50	14	124	77	60	45	SCD360-1250-2-2-140HA05-HP132	30568787
12,70	14	124	77	60	45	SCD360-1270-2-2-140HA05-HP132	30568788
12,80	14	124	77	60	45	SCD360-1280-2-2-140HA05-HP132	30568789
13,00	14	124	77	60	45	SCD360-1300-2-2-140HA05-HP132	30568790
13,10	14	124	77	60	45	SCD360-1310-2-2-140HA05-HP132	30569190
13,50	14	124	77	60	45	SCD360-1350-2-2-140HA05-HP132	30568792
13,70	14	124	77	60	45	SCD360-1370-2-2-140HA05-HP132	30568793
13,80	14	124	77	60	45	SCD360-1380-2-2-140HA05-HP132	30568794
14,00	14	124	77	60	45	SCD360-1400-2-2-140HA05-HP132	30568795
14,20	16	133	83	63	48	SCD360-1420-2-2-140HA05-HP132	30568796
14,50	16	133	83	63	48	SCD360-1450-2-2-140HA05-HP132	30568797
14,70	16	133	83	63	48	SCD360-1470-2-2-140HA05-HP132	30568798
14,80	16	133	83	63	48	SCD360-1480-2-2-140HA05-HP132	30568799
15,00	16	133	83	63	48	SCD360-1500-2-2-140HA05-HP132	30568800
15,50	16	133	83	63	48	SCD360-1550-2-2-140HA05-HP132	30568801
15,70	16	133	83	63	48	SCD360-1570-2-2-140HA05-HP132	30568802
15,80	16	133	83	63	48	SCD360-1580-2-2-140HA05-HP132	30568803
16,00	16	133	83	63	48	SCD360-1600-2-2-140HA05-HP132	30568804
16,50	18	143	93	71	48	SCD360-1650-2-2-140HA05-HP132	30568805
17,00	18	143	93	71	48	SCD360-1700-2-2-140HA05-HP132	30568807
17,50	18	143	93	71	48	SCD360-1750-2-2-140HA05-HP132	30568808
18,00	18	143	93	71	48	SCD360-1800-2-2-140HA05-HP132	30568810
18,50	20	153	101	77	50	SCD360-1850-2-2-140HA05-HP132	30568811
18,80	20	153	101	77	50	SCD360-1880-2-2-140HA05-HP132	30568812
19,00	20	153	101	77	50	SCD360-1900-2-2-140HA05-HP132	30568813
19,80	20	153	101	77	50	SCD360-1980-2-2-140HA05-HP132	30568815
20,00	20	153	101	77	50	SCD360-2000-2-2-140HA05-HP132	30568816

Configurable features



Shank form:
Shank form: HB | HE

**Specification:**

SCD360-0430-2-2-140[shank form]05-HP132

Example:

SCD360-0430-2-2-140HE05-HP132

Shank form HE

Dimensions in mm.

* Particularly suitable for the premanufacturing of core bores for thread formers.

For cutting data recommendations, see end of chapter.

Special designs and other coatings available upon request.

ECU-Drill-Steel

Solid carbide twist drill
SCD361 (8xD), internal coolant supply

Design:

Drill diameter: 3.00 - 20.00 mm
Bore tolerance: ≥ IT 9
Cutting material: HP132
Number of cutting edges: 2
Tip angle: 135°
Helix angle: 30°

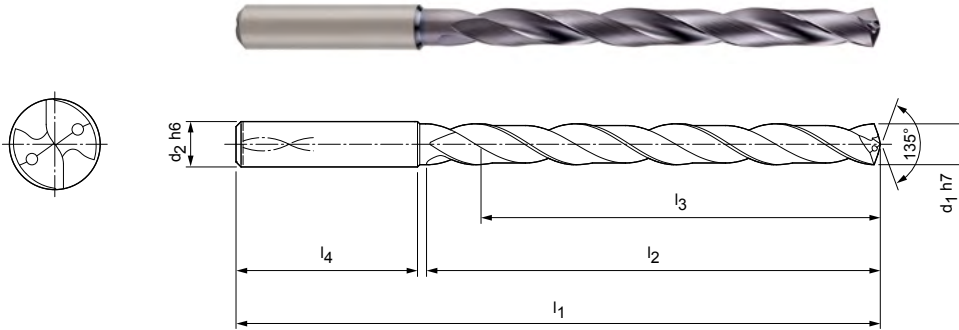

Stocked preferred series in shank form HA

Dimensions						Shank form HA	
d ₁ h7	d ₂ h6	l ₁	l ₂	l ₃	l ₄	Specification	Order no.
3,00	6	72	34	29	36	SCD361-0300-2-2-135HA08-HP132	30677713
3,10	6	72	34	29	36	SCD361-0310-2-2-135HA08-HP132	30677714
3,20	6	72	34	29	36	SCD361-0320-2-2-135HA08-HP132	30677715
3,30	6	72	34	29	36	SCD361-0330-2-2-135HA08-HP132	30677716
3,40	6	72	34	29	36	SCD361-0340-2-2-135HA08-HP132	30677717
3,50	6	72	34	29	36	SCD361-0350-2-2-135HA08-HP132	30677718
3,60	6	72	34	29	36	SCD361-0360-2-2-135HA08-HP132	30677719
3,70	6	72	34	29	36	SCD361-0370-2-2-135HA08-HP132	30677720
3,80	6	81	43	36	36	SCD361-0380-2-2-135HA08-HP132	30677721
3,90	6	81	43	36	36	SCD361-0390-2-2-135HA08-HP132	30677722
4,00	6	81	43	36	36	SCD361-0400-2-2-135HA08-HP132	30677723
4,10	6	81	43	36	36	SCD361-0410-2-2-135HA08-HP132	30677724
4,20	6	81	43	36	36	SCD361-0420-2-2-135HA08-HP132	30677725
4,30	6	81	43	36	36	SCD361-0430-2-2-135HA08-HP132	30677726
4,40	6	81	43	36	36	SCD361-0440-2-2-135HA08-HP132	30677727
4,50	6	81	43	36	36	SCD361-0450-2-2-135HA08-HP132	30677728
4,60	6	81	43	36	36	SCD361-0460-2-2-135HA08-HP132	30677729
4,70	6	81	43	36	36	SCD361-0470-2-2-135HA08-HP132	30677730
4,80	6	95	57	48	36	SCD361-0480-2-2-135HA08-HP132	30677731
4,90	6	95	57	48	36	SCD361-0490-2-2-135HA08-HP132	30677732
5,00	6	95	57	48	36	SCD361-0500-2-2-135HA08-HP132	30677733
5,10	6	95	57	48	36	SCD361-0510-2-2-135HA08-HP132	30677734
5,20	6	95	57	48	36	SCD361-0520-2-2-135HA08-HP132	30677735
5,30	6	95	57	48	36	SCD361-0530-2-2-135HA08-HP132	30677736
5,50	6	95	57	48	36	SCD361-0550-2-2-135HA08-HP132	30677738
5,70	6	95	57	48	36	SCD361-0570-2-2-135HA08-HP132	30677740
5,80	6	95	57	48	36	SCD361-0580-2-2-135HA08-HP132	30677741
5,90	6	95	57	48	36	SCD361-0590-2-2-135HA08-HP132	30677742
6,00	6	95	57	48	36	SCD361-0600-2-2-135HA08-HP132	30677743
6,10	8	114	76	64	36	SCD361-0610-2-2-135HA08-HP132	30677744
6,20	8	114	76	64	36	SCD361-0620-2-2-135HA08-HP132	30677745
6,30	8	114	76	64	36	SCD361-0630-2-2-135HA08-HP132	30677746
6,50	8	114	76	64	36	SCD361-0650-2-2-135HA08-HP132	30677748
6,60	8	114	76	64	36	SCD361-0660-2-2-135HA08-HP132	30677749
6,70	8	114	76	64	36	SCD361-0670-2-2-135HA08-HP132	30677751

ECU-Drill-Steel | Solid carbide twist drill SCD361 (8xD), internal coolant supply

Dimensions						Shank form HA	
d ₁ h7	d ₂ h6	l ₁	l ₂	l ₃	l ₄	Specification	Order no.
6,80	8	114	76	64	36	SCD361-0680-2-2-135HA08-HP132	30677752
6,90	8	114	76	64	36	SCD361-0690-2-2-135HA08-HP132	30677753
7,00	8	114	76	64	36	SCD361-0700-2-2-135HA08-HP132	30677754
7,10	8	114	76	64	36	SCD361-0710-2-2-135HA08-HP132	30677755
7,40	8	114	76	64	36	SCD361-0740-2-2-135HA08-HP132	30677758
7,50	8	114	76	64	36	SCD361-0750-2-2-135HA08-HP132	30677759
7,70	8	114	76	64	36	SCD361-0770-2-2-135HA08-HP132	30677761
7,80	8	114	76	64	36	SCD361-0780-2-2-135HA08-HP132	30677762
7,90	8	114	76	64	36	SCD361-0790-2-2-135HA08-HP132	30677763
8,00	8	114	76	64	36	SCD361-0800-2-2-135HA08-HP132	30677764
8,10	10	142	95	80	40	SCD361-0810-2-2-135HA08-HP132	30677765
8,20	10	142	95	80	40	SCD361-0820-2-2-135HA08-HP132	30677766
8,30	10	142	95	80	40	SCD361-0830-2-2-135HA08-HP132	30677767
8,50	10	142	95	80	40	SCD361-0850-2-2-135HA08-HP132	30677769
8,60	10	142	95	80	40	SCD361-0860-2-2-135HA08-HP132	30677770
8,70	10	142	95	80	40	SCD361-0870-2-2-135HA08-HP132	30677772
8,80	10	142	95	80	40	SCD361-0880-2-2-135HA08-HP132	30677773
9,00	10	142	95	80	40	SCD361-0900-2-2-135HA08-HP132	30677775
9,10	10	142	95	80	40	SCD361-0910-2-2-135HA08-HP132	30677776
9,20	10	142	95	80	40	SCD361-0920-2-2-135HA08-HP132	30677777
9,30	10	142	95	80	40	SCD361-0930-2-2-135HA08-HP132	30677778
9,40	10	142	95	80	40	SCD431-0940-2-2-135HA08-HP765	30550363
9,50	10	142	95	80	40	SCD361-0950-2-2-135HA08-HP132	30677780
9,70	10	142	95	80	40	SCD361-0970-2-2-135HA08-HP132	30677782
9,80	10	142	95	80	40	SCD361-0980-2-2-135HA08-HP132	30677783
9,90	10	142	95	80	40	SCD361-0990-2-2-135HA08-HP132	30677784
10,00	10	142	95	80	40	SCD361-1000-2-2-135HA08-HP132	30677785
10,20	12	162	114	96	45	SCD361-1020-2-2-135HA08-HP132	30677787
10,30	12	162	114	96	45	SCD361-1030-2-2-135HA08-HP132	30677788
10,50	12	162	114	96	45	SCD361-1050-2-2-135HA08-HP132	30677790
10,80	12	162	114	96	45	SCD361-1080-2-2-135HA08-HP132	30677793
11,00	12	162	114	96	45	SCD361-1100-2-2-135HA08-HP132	30677795
11,20	12	162	114	96	45	SCD361-1120-2-2-135HA08-HP132	30677797
11,50	12	162	114	96	45	SCD361-1150-2-2-135HA08-HP132	30677800
11,70	12	162	114	96	45	SCD361-1170-2-2-135HA08-HP132	30677802
11,80	12	162	114	96	45	SCD361-1180-2-2-135HA08-HP132	30677803
12,00	12	162	114	96	45	SCD361-1200-2-2-135HA08-HP132	30677805
12,20	14	178	133	112	45	SCD361-1220-2-2-135HA08-HP132	30677806
12,50	14	178	133	112	45	SCD361-1250-2-2-135HA08-HP132	30677807
12,80	14	178	133	112	45	SCD361-1280-2-2-135HA08-HP132	30677808
13,00	14	178	133	112	45	SCD361-1300-2-2-135HA08-HP132	30677809
13,50	14	178	133	112	45	SCD361-1350-2-2-135HA08-HP132	30677811
13,80	14	178	133	112	45	SCD361-1380-2-2-135HA08-HP132	30677812
14,00	14	178	133	112	45	SCD361-1400-2-2-135HA08-HP132	30677813
14,50	16	203	152	128	48	SCD361-1450-2-2-135HA08-HP132	30677815
15,00	16	203	152	128	48	SCD361-1500-2-2-135HA08-HP132	30677817
15,50	16	203	152	128	48	SCD361-1550-2-2-135HA08-HP132	30677818
15,80	16	203	152	128	48	SCD361-1580-2-2-135HA08-HP132	30677819
16,00	16	203	152	128	48	SCD361-1600-2-2-135HA08-HP132	30677820
16,50	18	222	171	144	48	SCD361-1650-2-2-135HA08-HP132	30677821
17,00	18	222	171	144	48	SCD361-1700-2-2-135HA08-HP132	30677822
17,50	18	222	171	144	48	SCD361-1750-2-2-135HA08-HP132	30677823
18,00	18	222	171	144	48	SCD361-1800-2-2-135HA08-HP132	30677824
18,50	20	243	190	160	50	SCD361-1850-2-2-135HA08-HP132	30677825
19,00	20	243	190	160	50	SCD361-1900-2-2-135HA08-HP132	30677826
20,00	20	243	190	160	50	SCD361-2000-2-2-135HA08-HP132	30677828

Continued on next page.

ECU-Drill-Steel | Solid carbide twist drill SCD361 (8xD), internal coolant supply

Configurable features

 **Shank form:**
Shank form: HB | HE

Specification:
SCD361-0430-2-2-140[shank form]08-HP132

Example:

SCD361-0430-2-2-140HE08-HP132

Shank form HE

ECU-Drill-Steel

Solid carbide twist drill
SCD361 (12xD), internal coolant supply

Design:
 Drill diameter: 3.00 - 18.00 mm
 Bore tolerance: \geq IT 9
 Cutting material: HP132
 Number of cutting edges: 2
 Tip angle: 135°
 Helix angle: 30°

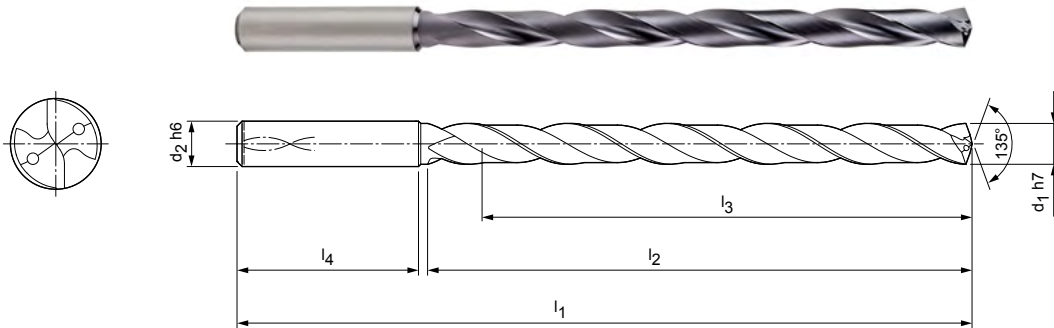

Stocked preferred series in shank form HA

Dimensions						Shank form HA	
d_1 h7	d_2 h6	l_1	l_2	l_3	l_4	Specification	Order no.
3,00	6	92	54	48	36	SCD361-0300-2-2-135HA12-HP132	30677829
3,10	6	92	54	48	36	SCD361-0310-2-2-135HA12-HP132	30677830
3,20	6	92	54	48	36	SCD361-0320-2-2-135HA12-HP132	30677831
3,30	6	92	54	48	36	SCD361-0330-2-2-135HA12-HP132	30677832
3,40	6	92	54	48	36	SCD361-0340-2-2-135HA12-HP132	30677833
3,50	6	92	54	48	36	SCD361-0350-2-2-135HA12-HP132	30677834
3,60	6	92	54	48	36	SCD361-0360-2-2-135HA12-HP132	30677835
3,70	6	92	54	48	36	SCD361-0370-2-2-135HA12-HP132	30677836
3,80	6	102	64	58	36	SCD361-0380-2-2-135HA12-HP132	30677837
3,90	6	102	64	58	36	SCD361-0390-2-2-135HA12-HP132	30677838
4,00	6	102	64	58	36	SCD361-0400-2-2-135HA12-HP132	30677839
4,10	6	102	64	58	36	SCD361-0410-2-2-135HA12-HP132	30677840
4,20	6	102	64	58	36	SCD361-0420-2-2-135HA12-HP132	30677841
4,30	6	102	64	58	36	SCD361-0430-2-2-135HA12-HP132	30677842
4,40	6	102	64	58	36	SCD361-0440-2-2-135HA12-HP132	30677843
4,50	6	102	64	58	36	SCD361-0450-2-2-135HA12-HP132	30677844
4,60	6	102	64	58	36	SCD361-0460-2-2-135HA12-HP132	30677845
4,70	6	102	64	58	36	SCD361-0470-2-2-135HA12-HP132	30677846
4,80	6	116	78	70	36	SCD361-0480-2-2-135HA12-HP132	30677847
4,90	6	116	78	70	36	SCD361-0490-2-2-135HA12-HP132	30677848
5,00	6	116	78	70	36	SCD361-0500-2-2-135HA12-HP132	30677849
5,10	6	116	78	70	36	SCD361-0510-2-2-135HA12-HP132	30677850
5,20	6	116	78	70	36	SCD361-0520-2-2-135HA12-HP132	30677851
5,50	6	116	78	70	36	SCD361-0550-2-2-135HA12-HP132	30677853
5,80	6	116	78	70	36	SCD361-0580-2-2-135HA12-HP132	30677854
6,00	6	116	78	70	36	SCD361-0600-2-2-135HA12-HP132	30677856
6,30	8	146	108	94	36	SCD361-0630-2-2-135HA12-HP132	30677859
6,50	8	146	108	94	36	SCD361-0650-2-2-135HA12-HP132	30677860
6,60	8	146	108	94	36	SCD361-0660-2-2-135HA12-HP132	30677861
6,80	8	146	108	94	36	SCD361-0680-2-2-135HA12-HP132	30677862
7,00	8	146	108	94	36	SCD361-0700-2-2-135HA12-HP132	30677863
7,40	8	146	108	94	36	SCD361-0740-2-2-135HA12-HP132	30677864
7,50	8	146	108	94	36	SCD361-0750-2-2-135HA12-HP132	30677865
7,80	8	146	108	94	36	SCD361-0780-2-2-135HA12-HP132	30677867
8,00	8	146	108	94	36	SCD361-0800-2-2-135HA12-HP132	30677869

ECU-Drill-Steel | Solid carbide twist drill SCD361 (12xD), internal coolant supply

Dimensions						Shank form HA	
d ₁ h7	d ₂ h6	l ₁	l ₂	l ₃	l ₄	Specification	Order no.
8,10	10	162	120	110	40	SCD361-0810-2-2-135HA12-HP132	30677870
8,20	10	162	120	110	40	SCD361-0820-2-2-135HA12-HP132	30677871
8,50	10	162	120	110	40	SCD361-0850-2-2-135HA12-HP132	30677874
9,00	10	162	120	110	40	SCD361-0900-2-2-135HA12-HP132	30677878
9,30	10	162	120	110	40	SCD361-0930-2-2-135HA12-HP132	30677881
9,50	10	162	120	110	40	SCD361-0950-2-2-135HA12-HP132	30677883
9,80	10	162	120	110	40	SCD361-0980-2-2-135HA12-HP132	30677885
10,00	10	162	120	110	40	SCD361-1000-2-2-135HA12-HP132	30677887
10,20	12	204	156	142	45	SCD361-1020-2-2-135HA12-HP132	30677888
10,50	12	204	156	142	45	SCD361-1050-2-2-135HA12-HP132	30677889
11,00	12	204	156	142	45	SCD361-1100-2-2-135HA12-HP132	30677891
11,50	12	204	156	142	45	SCD361-1150-2-2-135HA12-HP132	30677893
11,80	12	204	156	142	45	SCD361-1180-2-2-135HA12-HP132	30677894
12,00	12	204	156	142	45	SCD361-1200-2-2-135HA12-HP132	30677895
12,50	14	230	182	166	45	SCD361-1250-2-2-135HA12-HP132	30677896
13,00	14	230	182	166	45	SCD361-1300-2-2-135HA12-HP132	30677897
13,50	14	230	182	166	45	SCD361-1350-2-2-135HA12-HP132	30677899
14,00	14	230	182	166	45	SCD361-1400-2-2-135HA12-HP132	30677900
15,00	16	260	208	192	48	SCD361-1500-2-2-135HA12-HP132	30677903
16,00	16	260	208	192	48	SCD361-1600-2-2-135HA12-HP132	30677906
17,00	18	285	234	216	48	SCD361-1700-2-2-135HA12-HP132	30677908
17,50	18	285	234	216	48	SCD361-1750-2-2-135HA12-HP132	30677909
18,00	18	285	234	216	48	SCD361-1800-2-2-135HA12-HP132	30677910

Configurable features



Shank form:
Shank form: HB | HE



Specification:
SCD361-0430-2-2-140[shank form]12-HP132

Example:
SCD361-0430-2-2-140HE12-HP132

Shank form HE

Dimensions in mm.

For cutting data recommendations, see end of chapter.

Special designs and other coatings available upon request.

MEGA-Drill-Inox

Solid carbide twist drill
SCD120 (3xD), external coolant supply

Design:
 Drill diameter: 2.00 – 20.00 mm
 Bore tolerance: ≥ IT 9
 Cutting material: HP835
 Number of cutting edges: 2
 Number of guiding chamfers: 2
 Tip angle: 140°
 Helix angle: 30°

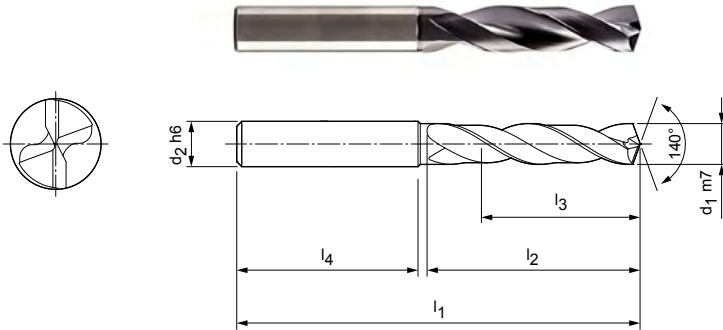

Stocked preferred series in shank form HA

Dimensions						Shank form HA	
d ₁ m7	d ₂ h6	l ₁	l ₂	l ₃	l ₄	Specification	Order no.
2,00	6	58	16	11	36	SCD120-0200-2-2-140HA03-HP835	30444703
2,10	6	58	16	11	36	SCD120-0210-2-2-140HA03-HP835	30453589
2,20	6	58	16	11	36	SCD120-0220-2-2-140HA03-HP835	30453826
2,30	6	58	16	11	36	SCD120-0230-2-2-140HA03-HP835	30453515
2,33	6	58	16	11	36	SCD120-0233-2-2-140HA03-HP835	30453605
2,40	6	58	16	11	36	SCD120-0240-2-2-140HA03-HP835	30444776
2,43	6	58	16	11	36	SCD120-0243-2-2-140HA03-HP835	30453606
2,50	6	58	16	11	36	SCD120-0250-2-2-140HA03-HP835	30451313
2,60	6	58	16	11	36	SCD120-0260-2-2-140HA03-HP835	30453541
2,62	6	58	16	11	36	SCD120-0262-2-2-140HA03-HP835	30453608
2,70	6	58	16	11	36	SCD120-0270-2-2-140HA03-HP835	30453525
2,80	6	58	16	11	36	SCD120-0280-2-2-140HA03-HP835	30453502
2,90	6	58	16	11	36	SCD120-0290-2-2-140HA03-HP835	30453546
3,00	6	62	22	14	36	SCD120-0300-2-2-140HA03-HP835	30390310
3,10	6	62	22	14	36	SCD120-0310-2-2-140HA03-HP835	30390311
3,15	6	62	22	14	36	SCD120-0315-2-2-140HA03-HP835	30453609
3,20	6	62	22	14	36	SCD120-0320-2-2-140HA03-HP835	30390312
3,22	6	62	22	14	36	SCD120-0322-2-2-140HA03-HP835	30453610
3,25	6	62	22	14	36	SCD120-0325-2-2-140HA03-HP835	30453611
3,30	6	62	22	14	36	SCD120-0330-2-2-140HA03-HP835	30390313
3,40	6	62	22	14	36	SCD120-0340-2-2-140HA03-HP835	30390314
3,50	6	62	22	14	36	SCD120-0350-2-2-140HA03-HP835	30390315
3,60	6	62	22	14	36	SCD120-0360-2-2-140HA03-HP835	30390316
3,70	6	62	22	14	36	SCD120-0370-2-2-140HA03-HP835	30390317
3,80	6	66	26	17	36	SCD120-0380-2-2-140HA03-HP835	30390318
3,90	6	66	26	17	36	SCD120-0390-2-2-140HA03-HP835	30390319
4,00	6	66	26	17	36	SCD120-0400-2-2-140HA03-HP835	30390320
4,05	6	66	26	17	36	SCD120-0405-2-2-140HA03-HP835	30445425
4,10	6	66	26	17	36	SCD120-0410-2-2-140HA03-HP835	30390321
4,20	6	66	26	17	36	SCD120-0420-2-2-140HA03-HP835	30390322
4,30	6	66	26	17	36	SCD120-0430-2-2-140HA03-HP835	30390323
4,35	6	66	26	17	36	SCD120-0435-2-2-140HA03-HP835	30453613
4,40	6	66	26	17	36	SCD120-0440-2-2-140HA03-HP835	30390324
4,50	6	66	26	17	36	SCD120-0450-2-2-140HA03-HP835	30390325
4,60	6	66	26	17	36	SCD120-0460-2-2-140HA03-HP835	30390326

MEGA-Drill-Inox | Solid carbide twist drill SCD120 (3xD), external coolant supply

Dimensions						Shank form HA	
d ₁ m7	d ₂ h6	l ₁	l ₂	l ₃	l ₄	Specification	Order no.
4,65	6	66	26	17	36	SCD120-0465-2-2-140HA03-HP835	30452080
4,70	6	66	26	17	36	SCD120-0470-2-2-140HA03-HP835	30390327
4,80	6	66	30	20	36	SCD120-0480-2-2-140HA03-HP835	30390328
4,90	6	66	30	20	36	SCD120-0490-2-2-140HA03-HP835	30390329
5,00	6	66	30	20	36	SCD120-0500-2-2-140HA03-HP835	30390330
5,03	6	66	30	20	36	SCD120-0503-2-2-140HA03-HP835	30453912
5,10	6	66	30	20	36	SCD120-0510-2-2-140HA03-HP835	30390331
5,20	6	66	30	20	36	SCD120-0520-2-2-140HA03-HP835	30390332
5,30	6	66	30	20	36	SCD120-0530-2-2-140HA03-HP835	30390333
5,40	6	66	30	20	36	SCD120-0540-2-2-140HA03-HP835	30390334
5,50	6	66	30	20	36	SCD120-0550-2-2-140HA03-HP835	30390335
5,55	6	66	30	20	36	SCD120-0555-2-2-140HA03-HP835	30452081
5,60	6	66	30	20	36	SCD120-0560-2-2-140HA03-HP835	30390336
5,70	6	66	30	20	36	SCD120-0570-2-2-140HA03-HP835	30390337
5,80	6	66	30	20	36	SCD120-0580-2-2-140HA03-HP835	30390338
5,90	6	66	30	20	36	SCD120-0590-2-2-140HA03-HP835	30390339
6,00	6	66	30	20	36	SCD120-0600-2-2-140HA03-HP835	30390340
6,10	8	79	38	24	36	SCD120-0610-2-2-140HA03-HP835	30390341
6,20	8	79	38	24	36	SCD120-0620-2-2-140HA03-HP835	30390342
6,30	8	79	38	24	36	SCD120-0630-2-2-140HA03-HP835	30390343
6,40	8	79	38	24	36	SCD120-0640-2-2-140HA03-HP835	30390344
6,50	8	79	38	24	36	SCD120-0650-2-2-140HA03-HP835	30390345
6,60	8	79	38	24	36	SCD120-0660-2-2-140HA03-HP835	30390346
6,70	8	79	38	24	36	SCD120-0670-2-2-140HA03-HP835	30390347
6,80	8	79	38	24	36	SCD120-0680-2-2-140HA03-HP835	30390348
6,90	8	79	38	24	36	SCD120-0690-2-2-140HA03-HP835	30390349
7,00	8	79	38	24	36	SCD120-0700-2-2-140HA03-HP835	30390350
7,20	8	79	42	29	36	SCD120-0720-2-2-140HA03-HP835	30390352
7,40	8	79	42	29	36	SCD120-0740-2-2-140HA03-HP835	30390354
7,45	8	79	42	29	36	SCD120-0745-2-2-140HA03-HP835	30453616
7,50	8	79	42	29	36	SCD120-0750-2-2-140HA03-HP835	30390355
7,70	8	79	42	29	36	SCD120-0770-2-2-140HA03-HP835	30390357
7,80	8	79	42	29	36	SCD120-0780-2-2-140HA03-HP835	30390358
7,90	8	79	42	29	36	SCD120-0790-2-2-140HA03-HP835	30390359
8,00	8	79	42	29	36	SCD120-0800-2-2-140HA03-HP835	30390360
8,10	10	89	49	35	40	SCD120-0810-2-2-140HA03-HP835	30390361
8,20	10	89	49	35	40	SCD120-0820-2-2-140HA03-HP835	30390362
8,30	10	89	49	35	40	SCD120-0830-2-2-140HA03-HP835	30390363
8,40	10	89	49	35	40	SCD120-0840-2-2-140HA03-HP835	30390364
8,50	10	89	49	35	40	SCD120-0850-2-2-140HA03-HP835	30390365
8,60	10	89	49	35	40	SCD120-0860-2-2-140HA03-HP835	30390366
8,70	10	89	49	35	40	SCD120-0870-2-2-140HA03-HP835	30390367
8,80	10	89	49	35	40	SCD120-0880-2-2-140HA03-HP835	30390368
8,90	10	89	49	35	40	SCD120-0890-2-2-140HA03-HP835	30390369
9,00	10	89	49	35	40	SCD120-0900-2-2-140HA03-HP835	30390370
9,10	10	89	49	35	40	SCD120-0910-2-2-140HA03-HP835	30390371
9,50	10	89	49	35	40	SCD120-0950-2-2-140HA03-HP835	30390375
9,80	10	89	49	35	40	SCD120-0980-2-2-140HA03-HP835	30390378
9,90	10	89	49	35	40	SCD120-0990-2-2-140HA03-HP835	30390379
10,00	10	89	49	35	40	SCD120-1000-2-2-140HA03-HP835	30390380
10,10	12	102	56	40	45	SCD120-1010-2-2-140HA03-HP835	30390381
10,20	12	102	56	40	45	SCD120-1020-2-2-140HA03-HP835	30390382
10,30	12	102	56	40	45	SCD120-1030-2-2-140HA03-HP835	30390383
10,50	12	102	56	40	45	SCD120-1050-2-2-140HA03-HP835	30390385
11,00	12	102	56	40	45	SCD120-1100-2-2-140HA03-HP835	30390390
11,50	12	102	56	40	45	SCD120-1150-2-2-140HA03-HP835	30390395
11,80	12	102	56	40	45	SCD120-1180-2-2-140HA03-HP835	30390398

MEGA-Drill-Inox | Solid carbide twist drill SCD120 (3xD), external coolant supply

Dimensions						Shank form HA	
d ₁ m7	d ₂ h6	l ₁	l ₂	l ₃	l ₄	Specification	Order no.
12,00	12	102	56	40	45	SCD120-1200-2-2-140HA03-HP835	30390400
12,15	14	107	61	43	45	SCD120-1215-2-2-140HA03-HP835	30453623
12,50	14	107	61	43	45	SCD120-1250-2-2-140HA03-HP835	30390401
12,80	14	107	61	43	45	SCD120-1280-2-2-140HA03-HP835	30445978
13,00	14	107	61	43	45	SCD120-1300-2-2-140HA03-HP835	30390402
13,80	14	107	61	43	45	SCD120-1380-2-2-140HA03-HP835	30445979
14,00	14	107	61	43	45	SCD120-1400-2-2-140HA03-HP835	30390404
15,00	16	115	65	45	48	SCD120-1500-2-2-140HA03-HP835	30390406
16,00	16	115	65	45	48	SCD120-1600-2-2-140HA03-HP835	30390408
17,00	18	123	73	51	48	SCD120-1700-2-2-140HA03-HP835	30390410
18,00	18	123	73	51	48	SCD120-1800-2-2-140HA03-HP835	30390412
19,00	20	131	79	55	50	SCD120-1900-2-2-140HA03-HP835	30390414

Configurable features



Diameter:
Diameter in increments of
0.01 mm freely selectable



Shank form:
Shank form: HB | HE

Specification:

SCD120-[diameter]-2-2-140[shank form]03-HP835

Example:

SCD120-0431-2-2-140HE03-HP835

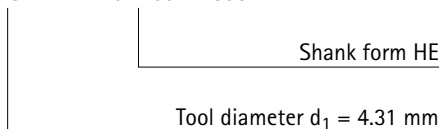

Dimensions of configurable series

d ₁ min.	d ₁ max.	d ₂ h6	l ₁	l ₂	l ₃	l ₄
2,00	2,99	6	58	16	11	36
3,00	3,70	6	62	22	14	36
3,71	4,70	6	66	26	17	36
4,71	5,97	6	66	30	20	36
5,98	6,00	6	66	30	20	36
6,01	7,00	8	79	38	24	36
7,01	7,97	8	79	42	29	36
7,98	8,00	8	79	42	29	36
8,01	9,97	10	89	49	35	40
9,98	10,00	10	89	49	35	40
10,01	12,00	12	102	56	40	45
12,01	14,00	14	107	61	43	45
14,01	16,00	16	115	65	45	48
16,01	18,00	18	123	73	51	48
18,01	20,00	20	131	79	55	50

Dimensions in mm.

For cutting data recommendations, see end of chapter.

Special designs and other coatings available upon request.

MEGA-Drill-Inox

Solid carbide twist drill
SCD121 (3xD), internal coolant supply

Design:

Drill diameter: 3.00 – 20.00 mm
Bore tolerance: \geq IT 9
Cutting material: HP835
Number of cutting edges: 2
Number of guiding chamfers: 2
Tip angle: 140°
Helix angle: 30°

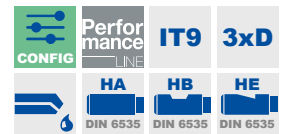
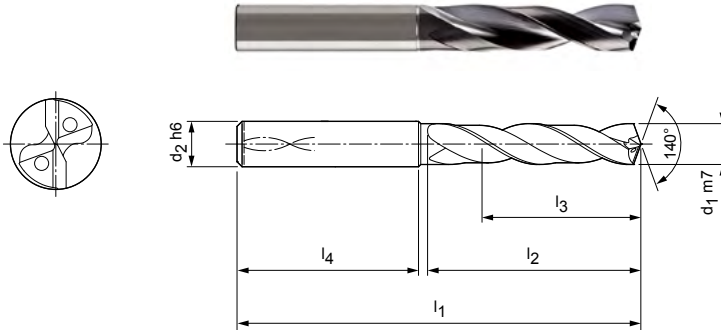

Stocked preferred series in shank form HA

Dimensions						Shank form HA	
d_1 m7	d_2 h6	l_1	l_2	l_3	l_4	Specification	Order no.
3,00	6	62	22	14	36	SCD121-0300-2-2-140HA03-HP835	30390523
3,05	6	62	22	14	36	SCD121-0305-2-2-140HA03-HP835	30445910
3,15	6	62	22	14	36	SCD121-0315-2-2-140HA03-HP835	30453629
3,20	6	62	22	14	36	SCD121-0320-2-2-140HA03-HP835	30390525
3,25	6	62	22	14	36	SCD121-0325-2-2-140HA03-HP835	30453631
3,30	6	62	22	14	36	SCD121-0330-2-2-140HA03-HP835	30390526
3,40	6	62	22	14	36	SCD121-0340-2-2-140HA03-HP835	30390527
3,50	6	62	22	14	36	SCD121-0350-2-2-140HA03-HP835	30390528
3,60	6	62	22	14	36	SCD121-0360-2-2-140HA03-HP835	30390529
3,70	6	62	22	14	36	SCD121-0370-2-2-140HA03-HP835	30390530
3,80	6	66	26	17	36	SCD121-0380-2-2-140HA03-HP835	30390531
3,90	6	66	26	17	36	SCD121-0390-2-2-140HA03-HP835	30390532
4,00	6	66	26	17	36	SCD121-0400-2-2-140HA03-HP835	30390533
4,10	6	66	26	17	36	SCD121-0410-2-2-140HA03-HP835	30390534
4,20	6	66	26	17	36	SCD121-0420-2-2-140HA03-HP835	30390535
4,30	6	66	26	17	36	SCD121-0430-2-2-140HA03-HP835	30390536
4,35	6	66	26	17	36	SCD121-0435-2-2-140HA03-HP835	30453633
4,40	6	66	26	17	36	SCD121-0440-2-2-140HA03-HP835	30390537
4,50	6	66	26	17	36	SCD121-0450-2-2-140HA03-HP835	30390538
4,65	6	66	26	17	36	SCD121-0465-2-2-140HA03-HP835	30438861
4,70	6	66	26	17	36	SCD121-0470-2-2-140HA03-HP835	30390540
4,80	6	66	30	20	36	SCD121-0480-2-2-140HA03-HP835	30390541
5,00	6	66	30	20	36	SCD121-0500-2-2-140HA03-HP835	30390543
5,10	6	66	30	20	36	SCD121-0510-2-2-140HA03-HP835	30390544
5,20	6	66	30	20	36	SCD121-0520-2-2-140HA03-HP835	30390545
5,30	6	66	30	20	36	SCD121-0530-2-2-140HA03-HP835	30390546
5,40	6	66	30	20	36	SCD121-0540-2-2-140HA03-HP835	30390547
5,50	6	66	30	20	36	SCD121-0550-2-2-140HA03-HP835	30390548
5,55	6	66	30	20	36	SCD121-0555-2-2-140HA03-HP835	30439052
5,60	6	66	30	20	36	SCD121-0560-2-2-140HA03-HP835	30390549
5,70	6	66	30	20	36	SCD121-0570-2-2-140HA03-HP835	30390550
5,80	6	66	30	20	36	SCD121-0580-2-2-140HA03-HP835	30390551
5,90	6	66	30	20	36	SCD121-0590-2-2-140HA03-HP835	30390552
5,95	6	66	30	20	36	SCD121-0595-2-2-140HA03-HP835	30453636
6,00	6	66	30	20	36	SCD121-0600-2-2-140HA03-HP835	30390553

MEGA-Drill-Inox | Solid carbide twist drill SCD121 (3xD), internal coolant supply

Dimensions						Shank form HA	
d ₁ m7	d ₂ h6	l ₁	l ₂	l ₃	l ₄	Specification	Order no.
6,10	8	79	38	24	36	SCD121-0610-2-2-140HA03-HP835	30390554
6,20	8	79	38	24	36	SCD121-0620-2-2-140HA03-HP835	30390555
6,30	8	79	38	24	36	SCD121-0630-2-2-140HA03-HP835	30390556
6,40	8	79	38	24	36	SCD121-0640-2-2-140HA03-HP835	30390557
6,50	8	79	38	24	36	SCD121-0650-2-2-140HA03-HP835	30390558
6,60	8	79	38	24	36	SCD121-0660-2-2-140HA03-HP835	30390559
6,70	8	79	38	24	36	SCD121-0670-2-2-140HA03-HP835	30390560
6,80	8	79	38	24	36	SCD121-0680-2-2-140HA03-HP835	30390561
6,90	8	79	38	24	36	SCD121-0690-2-2-140HA03-HP835	30390562
7,00	8	79	38	24	36	SCD121-0700-2-2-140HA03-HP835	30390563
7,10	8	79	42	29	36	SCD121-0710-2-2-140HA03-HP835	30390564
7,20	8	79	42	29	36	SCD121-0720-2-2-140HA03-HP835	30390565
7,30	8	79	42	29	36	SCD121-0730-2-2-140HA03-HP835	30390566
7,40	8	79	42	29	36	SCD121-0740-2-2-140HA03-HP835	30390567
7,45	8	79	42	29	36	SCD121-0745-2-2-140HA03-HP835	30453637
7,50	8	79	42	29	36	SCD121-0750-2-2-140HA03-HP835	30390568
7,70	8	79	42	29	36	SCD121-0770-2-2-140HA03-HP835	30390570
7,80	8	79	42	29	36	SCD121-0780-2-2-140HA03-HP835	30390571
7,90	8	79	42	29	36	SCD121-0790-2-2-140HA03-HP835	30390572
8,00	8	79	42	29	36	SCD121-0800-2-2-140HA03-HP835	30390573
8,10	10	89	49	35	40	SCD121-0810-2-2-140HA03-HP835	30390574
8,20	10	89	49	35	40	SCD121-0820-2-2-140HA03-HP835	30390575
8,30	10	89	49	35	40	SCD121-0830-2-2-140HA03-HP835	30390576
8,40	10	89	49	35	40	SCD121-0840-2-2-140HA03-HP835	30390577
8,50	10	89	49	35	40	SCD121-0850-2-2-140HA03-HP835	30390578
8,60	10	89	49	35	40	SCD121-0860-2-2-140HA03-HP835	30390579
8,70	10	89	49	35	40	SCD121-0870-2-2-140HA03-HP835	30390580
8,80	10	89	49	35	40	SCD121-0880-2-2-140HA03-HP835	30390581
9,00	10	89	49	35	40	SCD121-0900-2-2-140HA03-HP835	30390583
9,10	10	89	49	35	40	SCD121-0910-2-2-140HA03-HP835	30390584
9,20	10	89	49	35	40	SCD121-0920-2-2-140HA03-HP835	30390585
9,30	10	89	49	35	40	SCD121-0930-2-2-140HA03-HP835	30390586
9,35	10	89	49	35	40	SCD121-0935-2-2-140HA03-HP835	30450663
9,40	10	89	49	35	40	SCD121-0940-2-2-140HA03-HP835	30390587
9,50	10	89	49	35	40	SCD121-0950-2-2-140HA03-HP835	30390588
9,70	10	89	49	35	40	SCD121-0970-2-2-140HA03-HP835	30390590
9,80	10	89	49	35	40	SCD121-0980-2-2-140HA03-HP835	30390591
9,90	10	89	49	35	40	SCD121-0990-2-2-140HA03-HP835	30390592
10,00	10	89	49	35	40	SCD121-1000-2-2-140HA03-HP835	30390593
10,20	12	102	56	40	45	SCD121-1020-2-2-140HA03-HP835	30390595
10,30	12	102	56	40	45	SCD121-1030-2-2-140HA03-HP835	30390596
10,40	12	102	56	40	45	SCD121-1040-2-2-140HA03-HP835	30390597
10,50	12	102	56	40	45	SCD121-1050-2-2-140HA03-HP835	30390598
10,70	12	102	56	40	45	SCD121-1070-2-2-140HA03-HP835	30390600
10,80	12	102	56	40	45	SCD121-1080-2-2-140HA03-HP835	30390601
11,00	12	102	56	40	45	SCD121-1100-2-2-140HA03-HP835	30390603
11,10	12	102	56	40	45	SCD121-1110-2-2-140HA03-HP835	30390604
11,30	12	102	56	40	45	SCD121-1130-2-2-140HA03-HP835	30390606
11,50	12	102	56	40	45	SCD121-1150-2-2-140HA03-HP835	30390608
11,70	12	102	56	40	45	SCD121-1170-2-2-140HA03-HP835	30390610
11,80	12	102	56	40	45	SCD121-1180-2-2-140HA03-HP835	30390611
12,00	12	102	56	40	45	SCD121-1200-2-2-140HA03-HP835	30390613
12,15	14	107	61	43	45	SCD121-1215-2-2-140HA03-HP835	30453644
12,50	14	107	61	43	45	SCD121-1250-2-2-140HA03-HP835	30443976
12,80	14	107	61	43	45	SCD121-1280-2-2-140HA03-HP835	30445992
13,00	14	107	61	43	45	SCD121-1300-2-2-140HA03-HP835	30444778
13,50	14	107	61	43	45	SCD121-1350-2-2-140HA03-HP835	30390614

Continued on next page.

MEGA-Drill-Inox | Solid carbide twist drill SCD121 (3xD), internal coolant supply

Dimensions						Shank form HA	
d ₁ m7	d ₂ h6	l ₁	l ₂	l ₃	l ₄	Specification	Order no.
13,80	14	107	61	43	45	SCD121-1380-2-2-140HA03-HP835	30445993
14,00	14	107	61	43	45	SCD121-1400-2-2-140HA03-HP835	30445050
14,50	16	115	65	45	48	SCD121-1450-2-2-140HA03-HP835	30390615
15,00	16	115	65	45	48	SCD121-1500-2-2-140HA03-HP835	30390616
15,50	16	115	65	45	48	SCD121-1550-2-2-140HA03-HP835	30442531
15,80	16	115	65	45	48	SCD121-1580-2-2-140HA03-HP835	30445995
16,00	16	115	65	45	48	SCD121-1600-2-2-140HA03-HP835	30390617
17,50	18	123	73	51	48	SCD121-1750-2-2-140HA03-HP835	30390620
18,00	18	123	73	51	48	SCD121-1800-2-2-140HA03-HP835	30390621
20,00	20	131	79	55	50	SCD121-2000-2-2-140HA03-HP835	30390625

Configurable features

**Diameter:**

Diameter in increments of 0.01 mm freely selectable

**Shank form:**

Shank form: HB | HE

Specification:

SCD121-[diameter]-2-2-140[shank form]03-HP835

Example:

SCD121-0431-2-2-140HE03-HP835

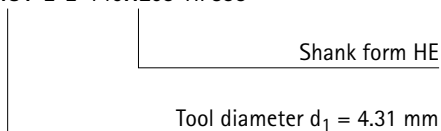

Dimensions of configurable series

d ₁ min.	d ₁ max.	d ₂ h6	l ₁	l ₂	l ₃	l ₄
3,71	4,70	6	66	26	17	36
4,71	6,00	6	66	30	20	36
6,01	7,00	8	79	38	24	36
7,01	8,00	8	79	42	29	36
8,01	10,00	10	89	49	35	40
10,01	12,00	12	102	56	40	45
12,01	14,00	14	107	61	43	45
14,01	16,00	16	115	65	45	48
16,01	18,00	18	123	73	51	48
18,01	20,00	20	131	79	55	50
18,01	20,00	20	131	79	55	50

Dimensions in mm.

For cutting data recommendations, see end of chapter.

Special designs and other coatings available upon request.

MEGA-Drill-Inox

Solid carbide twist drill
SCD120 (5xD), external coolant supply

Design:
 Drill diameter: 2.00 – 20.00 mm
 Bore tolerance: ≥ IT 9
 Cutting material: HP835
 Number of cutting edges: 2
 Number of guiding chamfers: 2
 Tip angle: 140°
 Helix angle: 30°

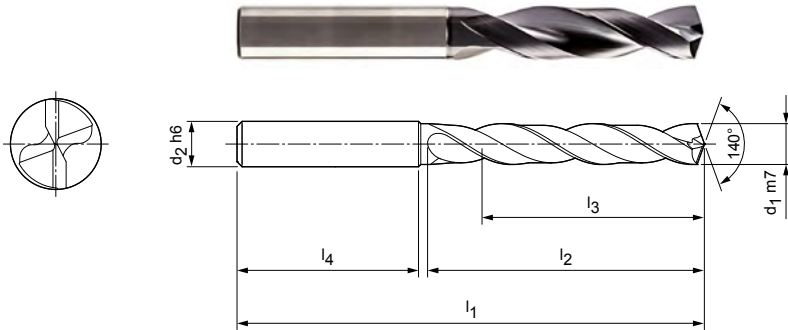

Stocked preferred series in shank form HA

Dimensions						Shank form HA	
d ₁ m7	d ₂ h6	l ₁	l ₂	l ₃	l ₄	Specification	Order no.
2,55	6	62	22	14	36	SCD120-0255-2-2-140HA05-HP835	30453607
3,00	6	66	28	23	36	SCD120-0300-2-2-140HA05-HP835	30390730
3,10	6	66	28	23	36	SCD120-0310-2-2-140HA05-HP835	30390731
3,20	6	66	28	23	36	SCD120-0320-2-2-140HA05-HP835	30390732
3,30	6	66	28	23	36	SCD120-0330-2-2-140HA05-HP835	30390733
3,40	6	66	28	23	36	SCD120-0340-2-2-140HA05-HP835	30390734
3,50	6	66	28	23	36	SCD120-0350-2-2-140HA05-HP835	30390735
3,60	6	66	28	23	36	SCD120-0360-2-2-140HA05-HP835	30390736
3,70	6	66	28	23	36	SCD120-0370-2-2-140HA05-HP835	30390737
3,80	6	74	36	29	36	SCD120-0380-2-2-140HA05-HP835	30390738
3,90	6	74	36	29	36	SCD120-0390-2-2-140HA05-HP835	30390739
4,00	6	74	36	29	36	SCD120-0400-2-2-140HA05-HP835	30390740
4,10	6	74	36	29	36	SCD120-0410-2-2-140HA05-HP835	30390741
4,20	6	74	36	29	36	SCD120-0420-2-2-140HA05-HP835	30390742
4,30	6	74	36	29	36	SCD120-0430-2-2-140HA05-HP835	30390743
4,40	6	74	36	29	36	SCD120-0440-2-2-140HA05-HP835	30390744
4,50	6	74	36	29	36	SCD120-0450-2-2-140HA05-HP835	30390745
4,60	6	74	36	29	36	SCD120-0460-2-2-140HA05-HP835	30390746
4,70	6	74	36	29	36	SCD120-0470-2-2-140HA05-HP835	30390747
4,80	6	82	44	35	36	SCD120-0480-2-2-140HA05-HP835	30390748
4,90	6	82	44	35	36	SCD120-0490-2-2-140HA05-HP835	30390749
5,00	6	82	44	35	36	SCD120-0500-2-2-140HA05-HP835	30390750
5,10	6	82	44	35	36	SCD120-0510-2-2-140HA05-HP835	30390751
5,20	6	82	44	35	36	SCD120-0520-2-2-140HA05-HP835	30390752
5,30	6	82	44	35	36	SCD120-0530-2-2-140HA05-HP835	30390753
5,40	6	82	44	35	36	SCD120-0540-2-2-140HA05-HP835	30390754
5,50	6	82	44	35	36	SCD120-0550-2-2-140HA05-HP835	30390755
5,60	6	82	44	35	36	SCD120-0560-2-2-140HA05-HP835	30390756
5,80	6	82	44	35	36	SCD120-0580-2-2-140HA05-HP835	30390758
6,00	6	82	44	35	36	SCD120-0600-2-2-140HA05-HP835	30390760
6,10	8	91	53	43	36	SCD120-0610-2-2-140HA05-HP835	30390761
6,20	8	91	53	43	36	SCD120-0620-2-2-140HA05-HP835	30390762
6,30	8	91	53	43	36	SCD120-0630-2-2-140HA05-HP835	30390763
6,40	8	91	53	43	36	SCD120-0640-2-2-140HA05-HP835	30390764
6,50	8	91	53	43	36	SCD120-0650-2-2-140HA05-HP835	30390765
6,60	8	91	53	43	36	SCD120-0660-2-2-140HA05-HP835	30390766
6,70	8	91	53	43	36	SCD120-0670-2-2-140HA05-HP835	30390767

MEGA-Drill-Inox | Solid carbide twist drill SCD120 (5xD), external coolant supply

Dimensions						Shank form HA	
d ₁ m7	d ₂ h6	l ₁	l ₂	l ₃	l ₄	Specification	Order no.
6,80	8	91	53	43	36	SCD120-0680-2-2-140HA05-HP835	30390768
6,90	8	91	53	43	36	SCD120-0690-2-2-140HA05-HP835	30390769
7,00	8	91	53	43	36	SCD120-0700-2-2-140HA05-HP835	30390770
7,10	8	91	53	43	36	SCD120-0710-2-2-140HA05-HP835	30390771
7,40	8	91	53	43	36	SCD120-0740-2-2-140HA05-HP835	30390774
7,50	8	91	53	43	36	SCD120-0750-2-2-140HA05-HP835	30390775
7,60	8	91	53	43	36	SCD120-0760-2-2-140HA05-HP835	30390776
7,80	8	91	53	43	36	SCD120-0780-2-2-140HA05-HP835	30390778
7,90	8	91	53	43	36	SCD120-0790-2-2-140HA05-HP835	30390779
8,00	8	91	53	43	36	SCD120-0800-2-2-140HA05-HP835	30390780
8,10	10	103	61	49	40	SCD120-0810-2-2-140HA05-HP835	30390781
8,20	10	103	61	49	40	SCD120-0820-2-2-140HA05-HP835	30390782
8,50	10	103	61	49	40	SCD120-0850-2-2-140HA05-HP835	30390785
8,60	10	103	61	49	40	SCD120-0860-2-2-140HA05-HP835	30390786
8,70	10	103	61	49	40	SCD120-0870-2-2-140HA05-HP835	30390787
8,80	10	103	61	49	40	SCD120-0880-2-2-140HA05-HP835	30390788
9,00	10	103	61	49	40	SCD120-0900-2-2-140HA05-HP835	30390790
9,20	10	103	61	49	40	SCD120-0920-2-2-140HA05-HP835	30390792
9,30	10	103	61	49	40	SCD120-0930-2-2-140HA05-HP835	30390793
9,40	10	103	61	49	40	SCD120-0940-2-2-140HA05-HP835	30390794
9,50	10	103	61	49	40	SCD120-0950-2-2-140HA05-HP835	30390795
10,00	10	103	61	49	40	SCD120-1000-2-2-140HA05-HP835	30390800
10,20	12	118	71	56	45	SCD120-1020-2-2-140HA05-HP835	30390802
10,30	12	118	71	56	45	SCD120-1030-2-2-140HA05-HP835	30390803
10,50	12	118	71	56	45	SCD120-1050-2-2-140HA05-HP835	30390805
10,80	12	118	71	56	45	SCD120-1080-2-2-140HA05-HP835	30390808
11,00	12	118	71	56	45	SCD120-1100-2-2-140HA05-HP835	30390810
11,70	12	118	71	56	45	SCD120-1170-2-2-140HA05-HP835	30390817
11,80	12	118	71	56	45	SCD120-1180-2-2-140HA05-HP835	30390818
12,00	12	118	71	56	45	SCD120-1200-2-2-140HA05-HP835	30390820
12,50	14	124	77	60	45	SCD120-1250-2-2-140HA05-HP835	30390821
13,00	14	124	77	60	45	SCD120-1300-2-2-140HA05-HP835	30390822
16,00	16	133	83	63	48	SCD120-1600-2-2-140HA05-HP835	30390828
16,50	18	143	93	71	48	SCD120-1650-2-2-140HA05-HP835	30445987

Configurable features



Diameter:
Diameter in increments of
0.01 mm freely selectable



Shank form:
Shank form: HB | HE

Specification:

SCD120-[diameter]-2-2-140[shank form]05-HP835

Dimensions of configurable series

d ₁ min.	d ₁ max.	d ₂ h6	l ₁	l ₂	l ₃	l ₄
2,00	2,70	6	62	22	14	36
2,71	3,70	6	66	28	23	36
3,71	4,70	6	74	36	29	36
4,71	5,97	6	82	44	35	36
5,98	6,00	6	82	44	35	36
6,01	7,97	8	91	53	43	36
7,98	8,00	8	91	53	43	36
8,01	9,97	10	103	61	49	40
9,98	10,00	10	103	61	49	40
10,01	12,00	12	118	71	56	45
12,01	14,00	14	124	77	60	45
14,01	16,00	16	133	83	63	48
16,01	18,00	18	143	93	71	48
18,01	20,00	20	153	101	77	50

Example:

SCD120-0431-2-2-140HE05-HP835

Shank form HE

Tool diameter d₁ = 4.31 mm

Dimensions in mm.

For cutting data recommendations, see end of chapter.

Special designs and other coatings available upon request.

MEGA-Drill-Inox

Solid carbide twist drill
SCD121 (5xD), internal coolant supply

Design:
 Drill diameter: 2.80 – 20.00 mm
 Bore tolerance: ≥ IT 9
 Cutting material: HP835
 Number of cutting edges: 2
 Number of guiding chamfers: 2
 Tip angle: 140°
 Helix angle: 30°

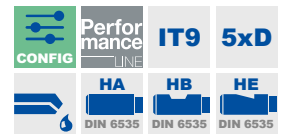
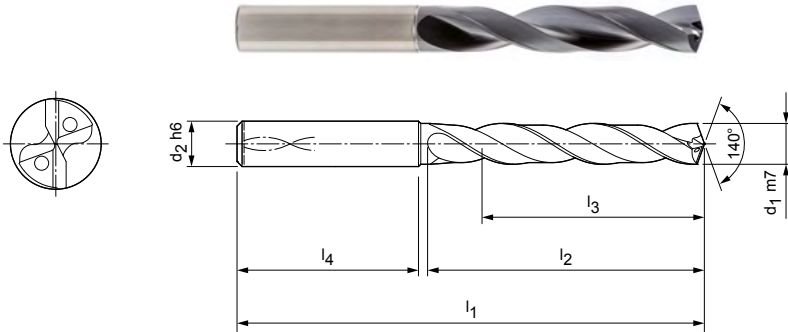

Stocked preferred series in shank form HA

Dimensions						Shank form HA	
d ₁ m7	d ₂ h6	l ₁	l ₂	l ₃	l ₄	Specification	Order no.
2,80	6	66	28	23	36	SCD121-0280-2-2-140HA05-HP835	30453905
3,00	6	66	28	23	36	SCD121-0300-2-2-140HA05-HP835	30390951
3,10	6	66	28	23	36	SCD121-0310-2-2-140HA05-HP835	30390952
3,15	6	66	28	23	36	SCD121-0315-2-2-140HA05-HP835	30430429
3,20	6	66	28	23	36	SCD121-0320-2-2-140HA05-HP835	30390953
3,22	6	66	28	23	36	SCD121-0322-2-2-140HA05-HP835	30453650
3,25	6	66	28	23	36	SCD121-0325-2-2-140HA05-HP835	30453651
3,30	6	66	28	23	36	SCD121-0330-2-2-140HA05-HP835	30390954
3,40	6	66	28	23	36	SCD121-0340-2-2-140HA05-HP835	30390955
3,50	6	66	28	23	36	SCD121-0350-2-2-140HA05-HP835	30390956
3,60	6	66	28	23	36	SCD121-0360-2-2-140HA05-HP835	30390957
3,70*	6	66	28	23	36	SCD121-0370-2-2-140HA05-HP835	30390958
3,80	6	74	36	29	36	SCD121-0380-2-2-140HA05-HP835	30390959
3,90	6	74	36	29	36	SCD121-0390-2-2-140HA05-HP835	30390960
4,00	6	74	36	29	36	SCD121-0400-2-2-140HA05-HP835	30390961
4,10	6	74	36	29	36	SCD121-0410-2-2-140HA05-HP835	30390962
4,15	6	74	36	29	36	SCD121-0415-2-2-140HA05-HP835	30454007
4,20	6	74	36	29	36	SCD121-0420-2-2-140HA05-HP835	30390963
4,30	6	74	36	29	36	SCD121-0430-2-2-140HA05-HP835	30390964
4,40	6	74	36	29	36	SCD121-0440-2-2-140HA05-HP835	30390965
4,45	6	74	36	29	36	SCD121-0445-2-2-140HA05-HP835	30453654
4,50	6	74	36	29	36	SCD121-0450-2-2-140HA05-HP835	30390966
4,60	6	74	36	29	36	SCD121-0460-2-2-140HA05-HP835	30390967
4,65*	6	74	36	29	36	SCD121-0465-2-2-140HA05-HP835	30453655
4,70	6	74	36	29	36	SCD121-0470-2-2-140HA05-HP835	30390968
4,80	6	82	44	35	36	SCD121-0480-2-2-140HA05-HP835	30390969
4,90	6	82	44	35	36	SCD121-0490-2-2-140HA05-HP835	30390970
5,00	6	82	44	35	36	SCD121-0500-2-2-140HA05-HP835	30390971
5,10	6	82	44	35	36	SCD121-0510-2-2-140HA05-HP835	30390972
5,20	6	82	44	35	36	SCD121-0520-2-2-140HA05-HP835	30390973
5,30	6	82	44	35	36	SCD121-0530-2-2-140HA05-HP835	30390974
5,40	6	82	44	35	36	SCD121-0540-2-2-140HA05-HP835	30390975
5,50	6	82	44	35	36	SCD121-0550-2-2-140HA05-HP835	30390976
5,60	6	82	44	35	36	SCD121-0560-2-2-140HA05-HP835	30390977
5,70	6	82	44	35	36	SCD121-0570-2-2-140HA05-HP835	30390978

MEGA-Drill-Inox | Solid carbide twist drill SCD121 (5xD), internal coolant supply

Dimensions						Shank form HA	
d ₁ m7	d ₂ h6	l ₁	l ₂	l ₃	l ₄	Specification	Order no.
5,80	6	82	44	35	36	SCD121-0580-2-2-140HA05-HP835	30390979
5,90	6	82	44	35	36	SCD121-0590-2-2-140HA05-HP835	30390980
5,95	6	82	44	35	36	SCD121-0595-2-2-140HA05-HP835	30453657
6,00	6	82	44	35	36	SCD121-0600-2-2-140HA05-HP835	30390981
6,10	8	91	53	43	36	SCD121-0610-2-2-140HA05-HP835	30390982
6,20	8	91	53	43	36	SCD121-0620-2-2-140HA05-HP835	30390983
6,30	8	91	53	43	36	SCD121-0630-2-2-140HA05-HP835	30390984
6,40	8	91	53	43	36	SCD121-0640-2-2-140HA05-HP835	30390985
6,50	8	91	53	43	36	SCD121-0650-2-2-140HA05-HP835	30390986
6,60	8	91	53	43	36	SCD121-0660-2-2-140HA05-HP835	30390987
6,70	8	91	53	43	36	SCD121-0670-2-2-140HA05-HP835	30390988
6,80	8	91	53	43	36	SCD121-0680-2-2-140HA05-HP835	30390989
6,90	8	91	53	43	36	SCD121-0690-2-2-140HA05-HP835	30390990
7,00	8	91	53	43	36	SCD121-0700-2-2-140HA05-HP835	30390991
7,10	8	91	53	43	36	SCD121-0710-2-2-140HA05-HP835	30390992
7,20	8	91	53	43	36	SCD121-0720-2-2-140HA05-HP835	30390993
7,30	8	91	53	43	36	SCD121-0730-2-2-140HA05-HP835	30390994
7,40	8	91	53	43	36	SCD121-0740-2-2-140HA05-HP835	30390995
7,45*	8	91	53	43	36	SCD121-0745-2-2-140HA05-HP835	30453658
7,50	8	91	53	43	36	SCD121-0750-2-2-140HA05-HP835	30390996
7,60	8	91	53	43	36	SCD121-0760-2-2-140HA05-HP835	30390997
7,70	8	91	53	43	36	SCD121-0770-2-2-140HA05-HP835	30390998
7,80	8	91	53	43	36	SCD121-0780-2-2-140HA05-HP835	30390999
8,00	8	91	53	43	36	SCD121-0800-2-2-140HA05-HP835	30391001
8,10	10	103	61	49	40	SCD121-0810-2-2-140HA05-HP835	30391002
8,20	10	103	61	49	40	SCD121-0820-2-2-140HA05-HP835	30391003
8,30	10	103	61	49	40	SCD121-0830-2-2-140HA05-HP835	30391004
8,50	10	103	61	49	40	SCD121-0850-2-2-140HA05-HP835	30391006
8,60	10	103	61	49	40	SCD121-0860-2-2-140HA05-HP835	30391007
8,70	10	103	61	49	40	SCD121-0870-2-2-140HA05-HP835	30391008
8,80	10	103	61	49	40	SCD121-0880-2-2-140HA05-HP835	30391009
8,90	10	103	61	49	40	SCD121-0890-2-2-140HA05-HP835	30391010
9,00	10	103	61	49	40	SCD121-0900-2-2-140HA05-HP835	30391011
9,10	10	103	61	49	40	SCD121-0910-2-2-140HA05-HP835	30391012
9,35	10	103	61	49	40	SCD121-0935-2-2-140HA05-HP835	30450706
9,40	10	103	61	49	40	SCD121-0940-2-2-140HA05-HP835	30391015
9,45	10	103	61	49	40	SCD121-0945-2-2-140HA05-HP835	30453660
9,50	10	103	61	49	40	SCD121-0950-2-2-140HA05-HP835	30391016
9,80	10	103	61	49	40	SCD121-0980-2-2-140HA05-HP835	30391019
9,90	10	103	61	49	40	SCD121-0990-2-2-140HA05-HP835	30391020
10,00	10	103	61	49	40	SCD121-1000-2-2-140HA05-HP835	30391021
10,20	12	118	71	56	45	SCD121-1020-2-2-140HA05-HP835	30391023
10,30	12	118	71	56	45	SCD121-1030-2-2-140HA05-HP835	30391024
10,50	12	118	71	56	45	SCD121-1050-2-2-140HA05-HP835	30391026
10,55	12	118	71	56	45	SCD121-1055-2-2-140HA05-HP835	30453661
10,80	12	118	71	56	45	SCD121-1080-2-2-140HA05-HP835	30391029
11,00	12	118	71	56	45	SCD121-1100-2-2-140HA05-HP835	30391031
11,20*	12	118	71	56	45	SCD121-1120-2-2-140HA05-HP835	30391033
11,25	12	118	71	56	45	SCD121-1125-2-2-140HA05-HP835	30453662
11,30	12	118	71	56	45	SCD121-1130-2-2-140HA05-HP835	30391034
11,50	12	118	71	56	45	SCD121-1150-2-2-140HA05-HP835	30391036
11,70	12	118	71	56	45	SCD121-1170-2-2-140HA05-HP835	30391038
11,80	12	118	71	56	45	SCD121-1180-2-2-140HA05-HP835	30391039
12,00	12	118	71	56	45	SCD121-1200-2-2-140HA05-HP835	30391041
12,50	14	124	77	60	45	SCD121-1250-2-2-140HA05-HP835	30391042
13,00	14	124	77	60	45	SCD121-1300-2-2-140HA05-HP835	30391044
13,50	14	124	77	60	45	SCD121-1350-2-2-140HA05-HP835	30391045

MEGA-Drill-Inox | Solid carbide twist drill SCD121 (5xD), internal coolant supply

Dimensions						Shank form HA	
d ₁ m7	d ₂ h6	l ₁	l ₂	l ₃	l ₄	Specification	Order no.
13,80	14	124	77	60	45	SCD121-1380-2-2-140HA05-HP835	30391046
14,00	14	124	77	60	45	SCD121-1400-2-2-140HA05-HP835	30391047
15,00	16	133	83	63	48	SCD121-1500-2-2-140HA05-HP835	30391050
16,00	16	133	83	63	48	SCD121-1600-2-2-140HA05-HP835	30391053
16,50	18	143	93	71	48	SCD121-1650-2-2-140HA05-HP835	30391054
17,00	18	143	93	71	48	SCD121-1700-2-2-140HA05-HP835	30391056
18,00	18	143	93	71	48	SCD121-1800-2-2-140HA05-HP835	30391059
20,00	20	153	101	77	50	SCD121-2000-2-2-140HA05-HP835	30391065

Configurable features



Diameter:
Diameter in increments of
0.01 mm freely selectable



Shank form:
Shank form: HB | HE

Specification:

SCD121-[diameter]-2-2-140[shank form]05-HP835

Dimensions of configurable series

d ₁ min.	d ₁ max.	d ₂ h6	l ₁	l ₂	l ₃	l ₄
3,71	4,70	6	74	36	29	36
4,71	6,00	6	82	44	35	36
6,01	8,00	8	91	53	43	36
8,01	10,00	10	103	61	49	40
10,01	12,00	12	118	71	56	45
12,01	14,00	14	124	77	60	45
14,01	16,00	16	133	83	63	45
16,01	18,00	18	143	93	71	48
18,01	20,00	20	153	101	77	50

Example:

SCD121-0431-2-2-140HE05-HP835

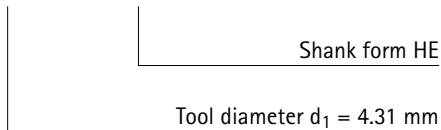

Dimensions in mm.

* Particularly suitable for the premanufacturing of core bores for thread formers.

For cutting data recommendations, see end of chapter.

Special designs and other coatings available upon request.

MEGA-Drill-Inox

Solid carbide twist drill
SCD121 (8xD), internal coolant supply

Design:

Drill diameter: 3.00 – 20.00 mm
Bore tolerance: \geq IT 9
Cutting material: HP835
Number of cutting edges: 2
Number of guiding chamfers: 2
Tip angle: 140°
Helix angle: 30°

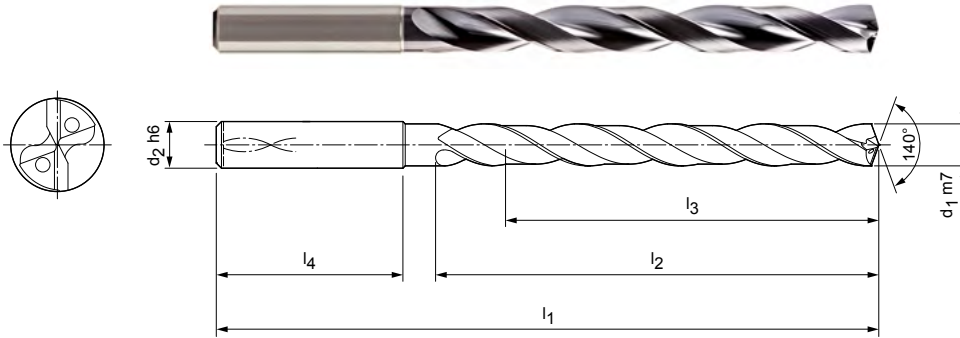

Stocked preferred series in shank form HA

Dimensions						Shank form HA	
d ₁ m7	d ₂ h6	l ₁	l ₂	l ₃	l ₄	Specification	Order no.
3,00	6	72	34	29	36	SCD121-0300-2-2-140HA08-HP835	30391171
3,20	6	72	34	29	36	SCD121-0320-2-2-140HA08-HP835	30391173
3,30	6	72	34	29	36	SCD121-0330-2-2-140HA08-HP835	30391174
3,40	6	72	34	29	36	SCD121-0340-2-2-140HA08-HP835	30391175
3,50	6	72	34	29	36	SCD121-0350-2-2-140HA08-HP835	30391176
3,70	6	72	34	29	36	SCD121-0370-2-2-140HA08-HP835	30391178
3,80	6	81	43	36	36	SCD121-0380-2-2-140HA08-HP835	30391179
3,90	6	81	43	36	36	SCD121-0390-2-2-140HA08-HP835	30391180
4,00	6	81	43	36	36	SCD121-0400-2-2-140HA08-HP835	30391181
4,20	6	81	43	36	36	SCD121-0420-2-2-140HA08-HP835	30391183
4,30	6	81	43	36	36	SCD121-0430-2-2-140HA08-HP835	30391184
4,40	6	81	43	36	36	SCD121-0440-2-2-140HA08-HP835	30391185
4,50	6	81	43	36	36	SCD121-0450-2-2-140HA08-HP835	30391186
4,80	6	95	57	48	36	SCD121-0480-2-2-140HA08-HP835	30391189
4,90	6	95	57	48	36	SCD121-0490-2-2-140HA08-HP835	30391190
5,00	6	95	57	48	36	SCD121-0500-2-2-140HA08-HP835	30391191
5,10	6	95	57	48	36	SCD121-0510-2-2-140HA08-HP835	30391192
5,30	6	95	57	48	36	SCD121-0530-2-2-140HA08-HP835	30391194
5,50	6	95	57	48	36	SCD121-0550-2-2-140HA08-HP835	30391196
5,60	6	95	57	48	36	SCD121-0560-2-2-140HA08-HP835	30391197
5,80	6	95	57	48	36	SCD121-0580-2-2-140HA08-HP835	30391199
5,90	6	95	57	48	36	SCD121-0590-2-2-140HA08-HP835	30391200
6,00	6	95	57	48	36	SCD121-0600-2-2-140HA08-HP835	30391201
6,10	8	114	76	64	36	SCD121-0610-2-2-140HA08-HP835	30391202
6,50	8	114	76	64	36	SCD121-0650-2-2-140HA08-HP835	30391206
6,60	8	114	76	64	36	SCD121-0660-2-2-140HA08-HP835	30391207
6,70	8	114	76	64	36	SCD121-0670-2-2-140HA08-HP835	30391208
6,80	8	114	76	64	36	SCD121-0680-2-2-140HA08-HP835	30391209
6,90	8	114	76	64	36	SCD121-0690-2-2-140HA08-HP835	30391210
7,00	8	114	76	64	36	SCD121-0700-2-2-140HA08-HP835	30391212
7,20	8	114	76	64	36	SCD121-0720-2-2-140HA08-HP835	30391214
7,50	8	114	76	64	36	SCD121-0750-2-2-140HA08-HP835	30391217
7,60	8	114	76	64	36	SCD121-0760-2-2-140HA08-HP835	30391218
7,80	8	114	76	64	36	SCD121-0780-2-2-140HA08-HP835	30391220
8,00	8	114	76	64	36	SCD121-0800-2-2-140HA08-HP835	30391222

MEGA-Drill-Inox | Solid carbide twist drill SCD121 (8xD), internal coolant supply

Dimensions						Shank form HA	
d ₁ m7	d ₂ h6	l ₁	l ₂	l ₃	l ₄	Specification	Order no.
8,50	10	142	95	80	40	SCD121-0850-2-2-140HA08-HP835	30391227
8,90	10	142	95	80	40	SCD121-0890-2-2-140HA08-HP835	30391231
9,00	10	142	95	80	40	SCD121-0900-2-2-140HA08-HP835	30391232
9,10	10	142	95	80	40	SCD121-0910-2-2-140HA08-HP835	30391233
9,30	10	142	95	80	40	SCD121-0930-2-2-140HA08-HP835	30391235
9,50	10	142	95	80	40	SCD121-0950-2-2-140HA08-HP835	30391237
9,60	10	142	95	80	40	SCD121-0960-2-2-140HA08-HP835	30391238
9,70	10	142	95	80	40	SCD121-0970-2-2-140HA08-HP835	30391239
9,80	10	142	95	80	40	SCD121-0980-2-2-140HA08-HP835	30391240
10,00	10	142	95	80	40	SCD121-1000-2-2-140HA08-HP835	30391242
10,10	12	162	114	96	45	SCD121-1010-2-2-140HA08-HP835	30391243
10,20	12	162	114	96	45	SCD121-1020-2-2-140HA08-HP835	30391244
10,80	12	162	114	96	45	SCD121-1080-2-2-140HA08-HP835	30391250
11,00	12	162	114	96	45	SCD121-1100-2-2-140HA08-HP835	30391252
11,50	12	162	114	96	45	SCD121-1150-2-2-140HA08-HP835	30391257
11,80	12	162	114	96	45	SCD121-1180-2-2-140HA08-HP835	30391260
12,00	12	162	114	96	45	SCD121-1200-2-2-140HA08-HP835	30391262
13,00	14	178	133	112	45	SCD121-1300-2-2-140HA08-HP835	30391265
13,50	14	178	133	112	45	SCD121-1350-2-2-140HA08-HP835	30391266
14,00	14	178	133	112	45	SCD121-1400-2-2-140HA08-HP835	30391268
14,50	16	203	152	128	48	SCD121-1450-2-2-140HA08-HP835	30391269
15,00	16	203	152	128	48	SCD121-1500-2-2-140HA08-HP835	30391271
18,00	18	222	171	144	48	SCD121-1800-2-2-140HA08-HP835	30391280

Configurable features



Diameter:
Diameter in increments of
0.01 mm freely selectable



Shank form:
Shank form: HB | HE

Specification:

SCD121-[diameter]-2-2-140[shank form]08-HP835

Dimensions of configurable series

d ₁ min.	d ₁ max.	d ₂ h6	l ₁	l ₂	l ₃	l ₄
3,71	4,70	6	81	43	36	36
4,71	6,00	6	95	57	48	36
6,01	8,00	8	114	76	64	36
8,01	10,00	10	142	95	80	40
10,01	12,00	12	162	114	96	45
12,01	14,00	14	178	133	112	45
14,01	16,00	16	203	152	128	48
16,01	18,00	18	222	171	144	48
18,01	20,00	20	243	190	160	50
16,01	18,00	18	123	73	51	48
18,01	20,00	20	131	79	55	50

Example:

SCD121-0431-2-2-140HE08-HP835

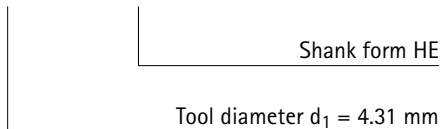

Dimensions in mm.

For cutting data recommendations, see end of chapter.

Special designs and other coatings available upon request.

MEGA-Speed-Drill-Inox

Solid carbide twist drill
SCD411 (5xD), internal coolant supply

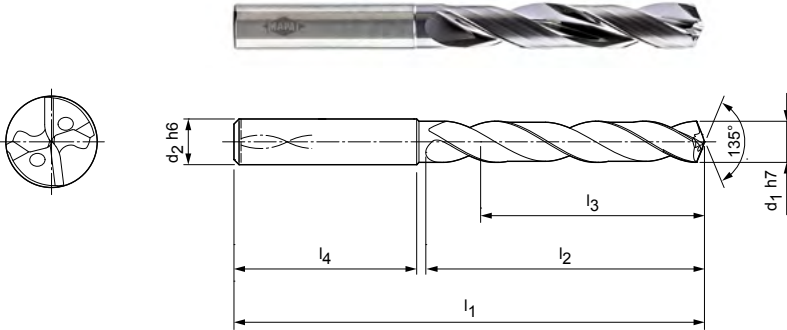

Design:
 Drill diameter: 3.00 – 20.00 mm
 Bore tolerance: ≥ IT 9
 Cutting material: HP374
 Number of cutting edges: 2
 Number of guiding chamfers: 3
 Tip angle: 135°
 Helix angle: 30°

Application:
 For high-speed machining.



Stocked preferred series in shank form HA

Dimensions						Shank form HA	
d ₁ h7	d ₂ h6	l ₁	l ₂	l ₃	l ₄	Specification	Order no.
3,00	6	66	28	23	36	SCD411-0300-2-3-135HA05-HP374	30488182
3,10	6	66	28	23	36	SCD411-0310-2-3-135HA05-HP374	30488183
3,20	6	66	28	23	36	SCD411-0320-2-3-135HA05-HP374	30488184
3,30	6	66	28	23	36	SCD411-0330-2-3-135HA05-HP374	30488185
3,40	6	66	28	23	36	SCD411-0340-2-3-135HA05-HP374	30488186
3,50	6	66	28	23	36	SCD411-0350-2-3-135HA05-HP374	30488187
3,70	6	66	28	23	36	SCD411-0370-2-3-135HA05-HP374	30488189
3,80	6	74	36	29	36	SCD411-0380-2-3-135HA05-HP374	30488190
4,00	6	74	36	29	36	SCD411-0400-2-3-135HA05-HP374	30488192
4,10	6	74	36	29	36	SCD411-0410-2-3-135HA05-HP374	30488193
4,20	6	74	36	29	36	SCD411-0420-2-3-135HA05-HP374	30488194
4,30	6	74	36	29	36	SCD411-0430-2-3-135HA05-HP374	30488195
4,50	6	74	36	29	36	SCD411-0450-2-3-135HA05-HP374	30488197
4,65	6	74	36	29	36	SCD411-0465-2-3-135HA05-HP374	30488199
4,70	6	74	36	29	36	SCD411-0470-2-3-135HA05-HP374	30488200
4,80	6	82	44	35	36	SCD411-0480-2-3-135HA05-HP374	30488201
5,00	6	82	44	35	36	SCD411-0500-2-3-135HA05-HP374	30488203
5,10	6	82	44	35	36	SCD411-0510-2-3-135HA05-HP374	30488204
5,20	6	82	44	35	36	SCD411-0520-2-3-135HA05-HP374	30488205
5,30	6	82	44	35	36	SCD411-0530-2-3-135HA05-HP374	30488206
5,50	6	82	44	35	36	SCD411-0550-2-3-135HA05-HP374	30488208
5,55	6	82	44	35	36	SCD411-0555-2-3-135HA05-HP374	30488209
5,60	6	82	44	35	36	SCD411-0560-2-3-135HA05-HP374	30488210
5,80	6	82	44	35	36	SCD411-0580-2-3-135HA05-HP374	30488212
5,90	6	82	44	35	36	SCD411-0590-2-3-135HA05-HP374	30488213
6,00	6	82	44	35	36	SCD411-0600-2-3-135HA05-HP374	30488214
6,10	8	91	53	43	36	SCD411-0610-2-3-135HA05-HP374	30488215
6,30	8	91	53	43	36	SCD411-0630-2-3-135HA05-HP374	30488217
6,50	8	91	53	43	36	SCD411-0650-2-3-135HA05-HP374	30488219
6,60	8	91	53	43	36	SCD411-0660-2-3-135HA05-HP374	30488220
6,80	8	91	53	43	36	SCD411-0680-2-3-135HA05-HP374	30488222
6,90	8	91	53	43	36	SCD411-0690-2-3-135HA05-HP374	30488223
7,00	8	91	53	43	36	SCD411-0700-2-3-135HA05-HP374	30488224
7,30	8	91	53	43	36	SCD411-0730-2-3-135HA05-HP374	30488227
7,40	8	91	53	43	36	SCD411-0740-2-3-135HA05-HP374	30488228

MEGA-Speed-Drill-Inox | Solid carbide twist drill SCD411 (5xD), internal coolant supply

Dimensions						Shank form HA	
d ₁ h7	d ₂ h6	l ₁	l ₂	l ₃	l ₄	Specification	Order no.
7,50	8	91	53	43	36	SCD411-0750-2-3-135HA05-HP374	30488229
7,60	8	91	53	43	36	SCD411-0760-2-3-135HA05-HP374	30488230
7,80	8	91	53	43	36	SCD411-0780-2-3-135HA05-HP374	30488232
8,00	8	91	53	43	36	SCD411-0800-2-3-135HA05-HP374	30488234
8,30	10	103	61	49	40	SCD411-0830-2-3-135HA05-HP374	30488237
8,50	10	103	61	49	40	SCD411-0850-2-3-135HA05-HP374	30488239
8,60	10	103	61	49	40	SCD411-0860-2-3-135HA05-HP374	30488240
8,70	10	103	61	49	40	SCD411-0870-2-3-135HA05-HP374	30488241
8,80	10	103	61	49	40	SCD411-0880-2-3-135HA05-HP374	30488242
8,90	10	103	61	49	40	SCD411-0890-2-3-135HA05-HP374	30488243
9,00	10	103	61	49	40	SCD411-0900-2-3-135HA05-HP374	30488244
9,20	10	103	61	49	40	SCD411-0920-2-3-135HA05-HP374	30488246
9,50	10	103	61	49	40	SCD411-0950-2-3-135HA05-HP374	30488249
9,70	10	103	61	49	40	SCD411-0970-2-3-135HA05-HP374	30488251
9,80	10	103	61	49	40	SCD411-0980-2-3-135HA05-HP374	30488252
9,90	10	103	61	49	40	SCD411-0990-2-3-135HA05-HP374	30488253
10,00	10	103	61	49	40	SCD411-1000-2-3-135HA05-HP374	30488254
10,20	12	118	71	56	45	SCD411-1020-2-3-135HA05-HP374	30488256
10,30	12	118	71	56	45	SCD411-1030-2-3-135HA05-HP374	30488257
10,50	12	118	71	56	45	SCD411-1050-2-3-135HA05-HP374	30488259
10,80	12	118	71	56	45	SCD411-1080-2-3-135HA05-HP374	30488262
11,00	12	118	71	56	45	SCD411-1100-2-3-135HA05-HP374	30488264
11,50	12	118	71	56	45	SCD411-1150-2-3-135HA05-HP374	30488269
11,80	12	118	71	56	45	SCD411-1180-2-3-135HA05-HP374	30488272
12,00	12	118	71	56	45	SCD411-1200-2-3-135HA05-HP374	30488274
12,20	14	124	77	60	45	SCD411-1220-2-3-135HA05-HP374	31307527
12,50	14	124	77	60	45	SCD411-1250-2-3-135HA05-HP374	30488275
12,80	14	124	77	60	45	SCD411-1280-2-3-135HA05-HP374	30488276
13,00	14	124	77	60	45	SCD411-1300-2-3-135HA05-HP374	30488277
13,50	14	124	77	60	45	SCD411-1350-2-3-135HA05-HP374	30488278
14,00	14	124	77	60	45	SCD411-1400-2-3-135HA05-HP374	30488280
14,20	16	133	83	63	48	SCD411-1420-2-3-135HA05-HP374	30661538
14,50	16	133	83	71	48	SCD411-1450-2-3-135HA05-HP374	30488281
15,00	16	133	83	71	48	SCD411-1500-2-3-135HA05-HP374	30488283
16,00	16	133	83	71	48	SCD411-1600-2-3-135HA05-HP374	30488286
17,00	18	143	93	71	48	SCD411-1700-2-3-135HA05-HP374	30488289
17,50	18	143	93	71	48	SCD411-1750-2-3-135HA05-HP374	30488290
18,00	18	143	93	71	48	SCD411-1800-2-3-135HA05-HP374	30488292
18,50	20	153	101	77	50	SCD411-1850-2-3-135HA05-HP374	30488293
20,00	20	153	101	77	50	SCD411-2000-2-3-135HA05-HP374	30488298

Continued on next page.

MEGA-Speed-Drill-Inox | Solid carbide twist drill SCD411 (5xD), internal coolant supply

Configurable features

**Diameter:**

Diameter in increments of 0.01 mm freely selectable

**Shank form:**

Shank form: HB | HE

Specification:

SCD411-[diameter]-2-3-135[shank form]05-HP374

Dimensions of configurable series

d ₁ min.	d ₁ max.	d ₂ h6	l ₁	l ₂	l ₃	l ₄
3,00	3,70	6	66	28	23	36
3,71	4,70	6	74	36	29	36
4,71	6,00	6	82	44	35	36
6,01	8,00	8	91	53	43	36
8,01	10,00	10	103	61	49	40
10,01	12,00	12	118	71	56	45
12,01	14,00	14	124	77	60	45
14,01	16,00	16	133	83	63	48
16,01	18,00	18	143	93	71	48
18,01	20,00	20	153	101	77	50

Example:

SCD411-0431-2-3-140HE05-HP374

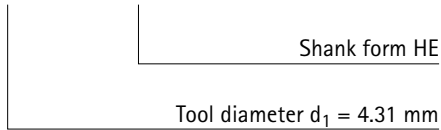

MEGA-Speed-Drill-Inox

Solid carbide twist drill
SCD411 (8xD), internal coolant supply

Design:
 Drill diameter: 3.00 – 20.00 mm
 Bore tolerance: \geq IT 9
 Cutting material: HP374
 Number of cutting edges: 2
 Number of guiding chamfers: 3
 Tip angle: 135°
 Helix angle: 30°

Application:
 For high-speed machining.

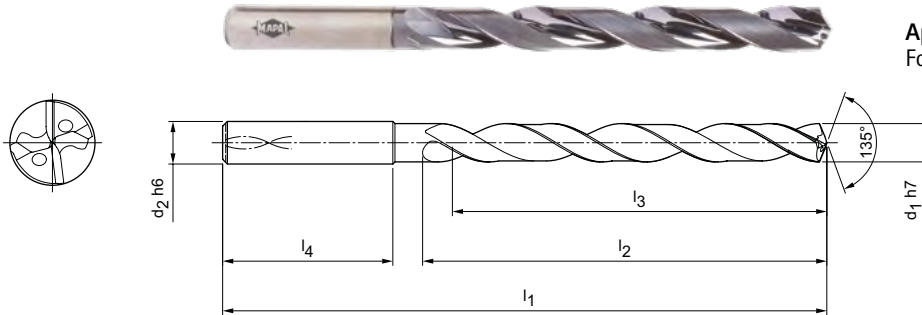

Stocked preferred series in shank form HA

Dimensions						Shank form HA	
d ₁ h7	d ₂ h6	l ₁	l ₂	l ₃	l ₄	Specification	Order no.
3,00	6	72	34	29	36	SCD411-0300-2-3-135HA08-HP374	31159372
3,20	6	72	34	29	36	SCD411-0320-2-3-135HA08-HP374	31159374
3,30	6	72	34	29	36	SCD411-0330-2-3-135HA08-HP374	31159375
3,40	6	72	34	29	36	SCD411-0340-2-3-135HA08-HP374	31159376
3,50	6	72	34	29	36	SCD411-0350-2-3-135HA08-HP374	31159377
3,70	6	72	34	29	36	SCD411-0370-2-3-135HA08-HP374	31159379
3,90	6	81	43	36	36	SCD411-0390-2-3-135HA08-HP374	31159391
4,00	6	81	43	36	36	SCD411-0400-2-3-135HA08-HP374	31159392
4,10	6	81	43	36	36	SCD411-0410-2-3-135HA08-HP374	31159393
4,20	6	81	43	36	36	SCD411-0420-2-3-135HA08-HP374	31159394
4,30	6	81	43	36	36	SCD411-0430-2-3-135HA08-HP374	31159395
4,50	6	81	43	36	36	SCD411-0450-2-3-135HA08-HP374	31159397
4,60	6	81	43	36	36	SCD411-0460-2-3-135HA08-HP374	31159398
4,80	6	95	57	48	36	SCD411-0480-2-3-135HA08-HP374	31159401
5,00	6	95	57	48	36	SCD411-0500-2-3-135HA08-HP374	31159403
5,10	6	95	57	48	36	SCD411-0510-2-3-135HA08-HP374	31159404
5,20	6	95	57	48	36	SCD411-0520-2-3-135HA08-HP374	31159405
5,40	6	95	57	48	36	SCD411-0540-2-3-135HA08-HP374	31159407
5,50	6	95	57	48	36	SCD411-0550-2-3-135HA08-HP374	31159408
5,80	6	95	57	48	36	SCD411-0580-2-3-135HA08-HP374	31159412
6,00	6	95	57	48	36	SCD411-0600-2-3-135HA08-HP374	31159414
6,10	8	114	76	64	36	SCD411-0610-2-3-135HA08-HP374	31159415
6,50	8	114	76	64	36	SCD411-0650-2-3-135HA08-HP374	31159419
6,80	8	114	76	64	36	SCD411-0680-2-3-135HA08-HP374	31159422
7,00	8	114	76	64	36	SCD411-0700-2-3-135HA08-HP374	31159424
7,50	8	114	76	64	36	SCD411-0750-2-3-135HA08-HP374	31159429
7,80	8	114	76	64	36	SCD411-0780-2-3-135HA08-HP374	31159432
8,00	8	114	76	64	36	SCD411-0800-2-3-135HA08-HP374	31159434
8,50	10	142	95	80	40	SCD411-0850-2-3-135HA08-HP374	31159439
9,00	10	142	95	80	40	SCD411-0900-2-3-135HA08-HP374	31159444
9,30	10	142	95	80	40	SCD411-0930-2-3-135HA08-HP374	31159447
9,50	10	142	95	80	40	SCD411-0950-2-3-135HA08-HP374	31159449
9,80	10	142	95	80	40	SCD411-0980-2-3-135HA08-HP374	31159452
10,00	10	142	95	80	40	SCD411-1000-2-3-135HA08-HP374	31159454
10,20	12	162	114	96	45	SCD411-1020-2-3-135HA08-HP374	31159456

MEGA-Speed-Drill-Inox | Solid carbide twist drill SCD411 (8xD), internal coolant supply

Dimensions						Shank form HA	
d ₁ h7	d ₂ h6	l ₁	l ₂	l ₃	l ₄	Specification	Order no.
10,50	12	162	114	96	45	SCD411-1050-2-3-135HA08-HP374	31159459
11,00	12	162	114	96	45	SCD411-1100-2-3-135HA08-HP374	31159464
11,80	12	162	114	96	45	SCD411-1180-2-3-135HA08-HP374	31159472
12,00	12	162	114	96	45	SCD411-1200-2-3-135HA08-HP374	31159474
12,50	14	178	133	112	45	SCD411-1250-2-3-135HA08-HP374	31159476
13,00	14	178	133	112	45	SCD411-1300-2-3-135HA08-HP374	31159478
13,50	14	178	133	112	45	SCD411-1350-2-3-135HA08-HP374	31159479
14,00	14	178	133	112	45	SCD411-1400-2-3-135HA08-HP374	31159481
15,00	16	203	152	128	48	SCD411-1500-2-3-135HA08-HP374	31159485
16,00	16	203	152	128	48	SCD411-1600-2-3-135HA08-HP374	31159489

Configurable features



Diameter:
Diameter in increments of
0.01 mm freely selectable



Shank form:
Shank form: HB | HE

Specification:

SCD411-[diameter]-2-3-135[shank form]08-HP374

Dimensions of configurable series

d ₁ min.	d ₁ max.	d ₂ h6	l ₁	l ₂	l ₃	l ₄
3,00	3,70	6	72	34	29	36
3,71	4,70	6	81	43	36	36
4,71	6,00	6	95	57	48	36
6,01	8,00	8	114	76	64	36
8,01	10,00	10	142	95	80	40
10,01	12,00	12	162	114	96	45
12,01	14,00	14	178	133	112	45
14,01	16,00	16	203	152	128	48
16,01	18,00	18	222	171	144	48
18,01	20,00	20	243	190	160	50

Example:

SCD411-**0431**-2-3-140**HE**08-HP374

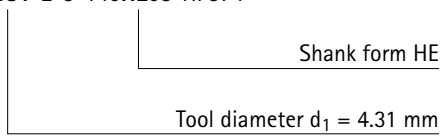

Dimensions in mm.

For cutting data recommendations, see end of chapter.

Special designs and other coatings available upon request.

MEGA-Speed-Drill-Inox

Solid carbide twist drill
SCD411 (12xD), internal coolant supply

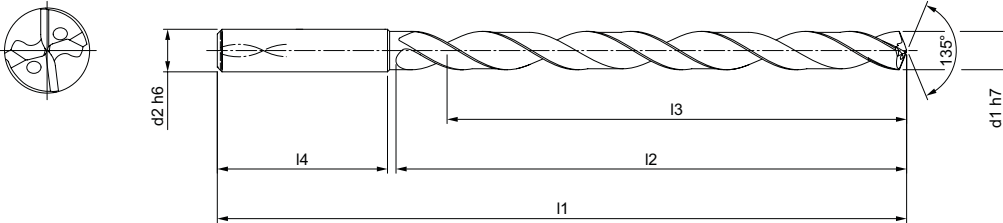

Design:
 Drill diameter: 3.00 – 20.00 mm
 Bore tolerance: \geq IT 9
 Cutting material: HP374
 Number of cutting edges: 2
 Number of guiding chamfers: 3
 Tip angle: 135°
 Helix angle: 30°

Application:
 For high-speed machining.



Stocked preferred series in shank form HA

Dimensions						Shank form HA	
d ₁ h7	d ₂ h6	l ₁	l ₂	l ₃	l ₄	Specification	Order no.
3,00	6	92	54	48	36	SCD411-0300-2-3-135HA12-HP374	31132678
3,10	6	92	54	48	36	SCD411-0310-2-3-135HA12-HP374	31132679
3,20	6	92	54	48	36	SCD411-0320-2-3-135HA12-HP374	31132690
3,30	6	92	54	48	36	SCD411-0330-2-3-135HA12-HP374	31132691
3,40	6	92	54	48	36	SCD411-0340-2-3-135HA12-HP374	31132692
3,50	6	92	54	48	36	SCD411-0350-2-3-135HA12-HP374	31132693
3,70	6	92	54	48	36	SCD411-0370-2-3-135HA12-HP374	31132695
4,00	6	102	64	58	36	SCD411-0400-2-3-135HA12-HP374	31132698
4,10	6	102	64	58	36	SCD411-0410-2-3-135HA12-HP374	31132699
4,20	6	102	64	58	36	SCD411-0420-2-3-135HA12-HP374	31132700
4,30	6	102	64	58	36	SCD411-0430-2-3-135HA12-HP374	31132701
4,50	6	102	64	58	36	SCD411-0450-2-3-135HA12-HP374	31132703
4,80	6	116	78	70	36	SCD411-0480-2-3-135HA12-HP374	31132706
5,00	6	116	78	70	36	SCD411-0500-2-3-135HA12-HP374	31132708
5,10	6	116	78	70	36	SCD411-0510-2-3-135HA12-HP374	31132709
5,20	6	116	78	70	36	SCD411-0520-2-3-135HA12-HP374	31132710
5,40	6	116	78	70	36	SCD411-0540-2-3-135HA12-HP374	31132712
5,50	6	116	78	70	36	SCD411-0550-2-3-135HA12-HP374	31132713
5,80	6	116	78	70	36	SCD411-0580-2-3-135HA12-HP374	31132716
6,00	6	116	78	70	36	SCD411-0600-2-3-135HA12-HP374	31132718
6,10	8	146	108	94	36	SCD411-0610-2-3-135HA12-HP374	31132719
6,20	8	146	108	94	36	SCD411-0620-2-3-135HA12-HP374	31132720
6,50	8	146	108	94	36	SCD411-0650-2-3-135HA12-HP374	31132723
6,80	8	146	108	94	36	SCD411-0680-2-3-135HA12-HP374	31132726
7,00	8	146	108	94	36	SCD411-0700-2-3-135HA12-HP374	31132728
7,50	8	146	108	94	36	SCD411-0750-2-3-135HA12-HP374	31132733
7,80	8	146	108	94	36	SCD411-0780-2-3-135HA12-HP374	31132736
8,00	8	146	108	94	36	SCD411-0800-2-3-135HA12-HP374	31132738
8,50	10	162	120	110	40	SCD411-0850-2-3-135HA12-HP374	31132743
9,00	10	162	120	110	40	SCD411-0900-2-3-135HA12-HP374	31132748
9,10	10	162	120	110	40	SCD411-0910-2-3-135HA12-HP374	31132749
9,50	10	162	120	110	40	SCD411-0950-2-3-135HA12-HP374	31132753
9,70	10	162	120	110	40	SCD411-0970-2-3-135HA12-HP374	31132755
9,80	10	162	120	110	40	SCD411-0980-2-3-135HA12-HP374	31132756
10,00	10	162	120	110	40	SCD411-1000-2-3-135HA12-HP374	31132758

MEGA-Speed-Drill-Inox | Solid carbide twist drill SCD411 (12xD), internal coolant supply

Dimensions						Shank form HA	
d ₁ h7	d ₂ h6	l ₁	l ₂	l ₃	l ₄	Specification	Order no.
10,10	12	204	156	142	45	SCD411-1010-2-3-135HA12-HP374	31132759
10,20	12	204	156	142	45	SCD411-1020-2-3-135HA12-HP374	31132760
10,50	12	204	156	142	45	SCD411-1050-2-3-135HA12-HP374	31132763
11,00	12	204	156	142	45	SCD411-1100-2-3-135HA12-HP374	31132768
11,80	12	204	156	142	45	SCD411-1180-2-3-135HA12-HP374	31132776
12,00	12	204	156	142	45	SCD411-1200-2-3-135HA12-HP374	31132778
12,50	14	230	182	166	45	SCD411-1250-2-3-135HA12-HP374	31132780
12,80	14	230	182	166	45	SCD411-1280-2-3-135HA12-HP374	31132781
13,00	14	230	182	166	45	SCD411-1300-2-3-135HA12-HP374	31132782
13,50	14	230	182	166	45	SCD411-1350-2-3-135HA12-HP374	31132783
14,00	14	230	182	166	45	SCD411-1400-2-3-135HA12-HP374	31132785
15,00	16	260	208	192	48	SCD411-1500-2-3-135HA12-HP374	31132788
16,00	16	260	208	192	48	SCD411-1600-2-3-135HA12-HP374	31132793

Configurable features

**Diameter:**

Diameter in increments of 0.01 mm freely selectable

**Shank form:**

Shank form: HB | HE

Specification:

SCD411-[diameter]-2-3-135[shank form]12-HP374

Dimensions of configurable series

d ₁ min.	d ₁ max.	d ₂ h6	l ₁	l ₂	l ₃	l ₄
3,00	3,70	6	92	54	48	36
3,71	4,70	6	102	64	58	36
4,71	6,00	6	116	78	70	36
6,01	8,00	8	146	108	94	36
8,01	10,00	10	162	120	110	40
10,01	12,00	12	204	156	142	45
12,01	14,00	14	230	182	166	45
14,01	16,00	16	260	208	192	48
16,01	18,00	18	285	234	216	48
18,01	20,00	20	310	258	240	50

Example:

SCD411-0431-2-3-140HE12-HP374

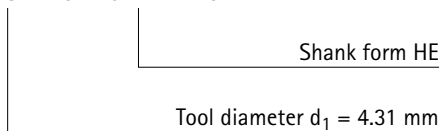

Dimensions in mm.

For cutting data recommendations, see end of chapter.

Special designs and other coatings available upon request.

MEGA-Speed-Drill-Iron

Solid carbide twist drill
SCD421 (5xD), internal coolant supply

Design:

Drill diameter: 3.00 – 20.00 mm
Bore tolerance: \geq IT 9
Cutting material: HP238
Number of cutting edges: 2
Number of guiding chamfers: 3
Tip angle: 130°
Helix angle: 30°

Application:

For high-speed machining.

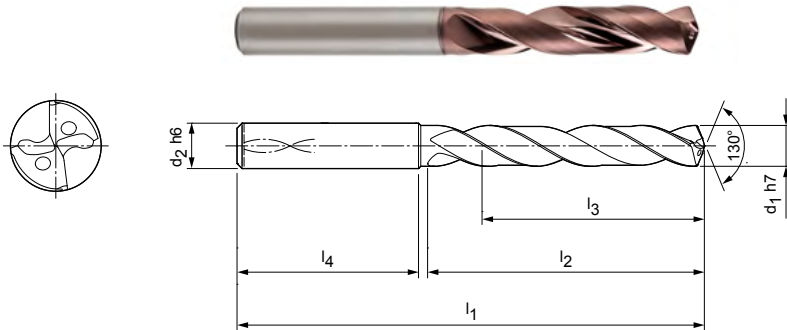

Stocked preferred series in shank form HA

Dimensions						Shank form HA	
d_1 h7	d_2 h6	l_1	l_2	l_3	l_4	Specification	Order no.
5,00	6	82	44	35	36	SCD421-0500-2-3-130HA05-HP238	30488320
5,10	6	82	44	35	36	SCD421-0510-2-3-130HA05-HP238	30488321
6,00	6	82	44	35	36	SCD421-0600-2-3-130HA05-HP238	30488331
6,90	8	91	53	43	36	SCD421-0690-2-3-130HA05-HP238	30488340
7,00	8	91	53	43	36	SCD421-0700-2-3-130HA05-HP238	30488341
7,20	8	91	53	43	36	SCD421-0720-2-3-130HA05-HP238	30488343
8,10	10	103	61	49	40	SCD421-0810-2-3-130HA05-HP238	30488352
8,50	10	103	61	49	40	SCD421-0850-2-3-130HA05-HP238	30488356
9,00	10	103	61	49	40	SCD421-0900-2-3-130HA05-HP238	30488361
14,00	14	124	77	60	45	SCD421-1400-2-3-130HA05-HP238	30488397
17,50	18	143	93	71	48	SCD421-1750-2-3-130HA05-HP238	30488407

Configurable features



Diameter:
Diameter in increments of
0.01 mm freely selectable



Shank form:
Shank form: HB | HE

Specification:

SCD421-[diameter]-2-3-130[shank form]05-HP238

Dimensions of configurable series

d_1 min.	d_1 max.	d_2 h6	l_1	l_2	l_3	l_4
3,00	3,70	6	66	28	23	36
3,71	4,79	6	74	36	29	36
4,80	6,00	6	82	44	35	36
6,01	8,00	8	91	53	43	36
8,01	10,00	10	103	61	49	40
10,01	12,00	12	118	71	56	45
12,01	14,00	14	124	77	60	45
14,01	16,00	16	133	83	63	48
16,01	18,00	18	143	93	71	48
18,01	20,00	20	153	101	77	50

Example:

SCD421-0431-2-3-130HE05-HP238

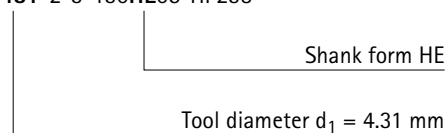

Dimensions in mm.

For cutting data recommendations, see end of chapter.
Special designs and other coatings available upon request.

MEGA-Drill-Alu

Solid carbide twist drill
SCD131 (3xD), internal coolant supply

Design:

Drill diameter: 3.00 – 20.00 mm
Bore tolerance: ≥ IT 9
Cutting material: HU630
Number of cutting edges: 2
Number of guiding chamfers: 2
Tip angle: 140°
Helix angle: 30°

Application:

Suitable for use as spotting drill for
MEGA-Deep-Drill-Alu.

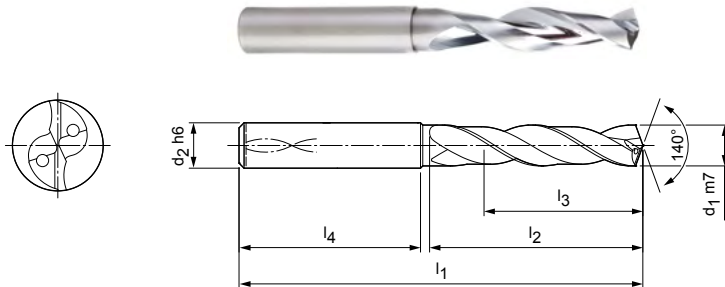

Stocked preferred series in shank form HA

Dimensions						Shank form HA	
d ₁ m7	d ₂ h6	l ₁	l ₂	l ₃	l ₄	Specification	Order no.
6,50	8	79	34	24	36	SCD131-0650-2-2-140HA03-HU630	30394280
6,70	8	79	34	24	36	SCD131-0670-2-2-140HA03-HU630	30446643
7,00	8	79	34	24	36	SCD131-0700-2-2-140HA03-HU630	30391294
10,00	10	89	47	35	40	SCD131-1000-2-2-140HA03-HU630	30391297
11,00	12	102	55	40	45	SCD131-1100-2-2-140HA03-HU630	30391298
12,00	12	102	55	40	45	SCD131-1200-2-2-140HA03-HU630	30391299
13,20	14	107	60	43	45	SCD131-1320-2-2-140HA03-HU630	30694326
13,70	14	107	60	43	45	SCD131-1370-2-2-140HA03-HU630	30694329
16,00	16	115	65	45	48	SCD131-1600-2-2-140HA03-HU630	30391303

Configurable features

Diameter:
Diameter in increments of 0.01 mm freely selectable

Shank form:
Shank form: HB | HE

Specification:
SCD131-[diameter]-2-2-140[shank form]03-HU630

Dimensions of configurable series

d ₁ min.	d ₁ max.	d ₂ h6	l ₁	l ₂	l ₃	l ₄
3,00	3,50	6	62	20	14	36
3,51	4,50	6	66	24	17	36
4,51	6,00	6	66	28	20	36
6,01	7,97	8	79	34	24	36
7,98	8,00	8	79	41	29	36
8,01	10,00	10	89	47	35	40
10,01	12,00	12	102	55	40	45
12,01	14,00	14	107	60	43	45
14,01	16,00	16	115	65	45	48
16,01	18,00	18	123	73	51	48
18,01	20,00	20	131	79	55	50

Example:

SCD131-0431-2-2-140HE03-HU630

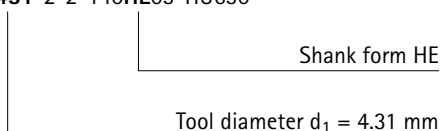

Dimensions in mm.

For cutting data recommendations, see end of chapter.

Special designs and other coatings available upon request.

MEGA-Drill-Alu

Solid carbide twist drill
SCD131 (5xD), internal coolant supply

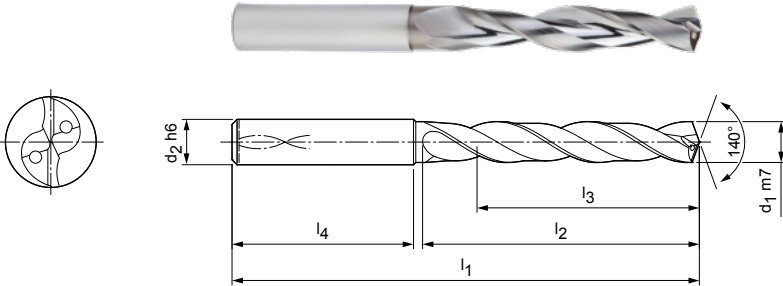

Design:

- Drill diameter: 2.80 – 20.00 mm
- Bore tolerance: ≥ IT 9
- Cutting material: HU630
- Number of cutting edges: 2
- Number of guiding chamfers: 2
- Tip angle: 140°
- Helix angle: 30°

Application:

Suitable for use as spotting drill for MEGA-Deep-Drill-Alu.

P
1
2
3
4
5
6
M
1
2
3
K
1
2
3
N
1
2
3
4
S
1
2
3
4
5
H
1
2
3

5xD

DIN 6535

DIN 6535

DIN 6535

Stocked preferred series in shank form HA

Dimensions						Shank form HA	
d ₁ m7	d ₂ h6	l ₁	l ₂	l ₃	l ₄	Specification	Order no.
3,00	6	66	28	23	36	SCD131-0300-2-2-140HA05-HU630	30391326
3,20	6	66	28	23	36	SCD131-0320-2-2-140HA05-HU630	30391328
3,30	6	66	28	23	36	SCD131-0330-2-2-140HA05-HU630	30391329
3,50	6	66	28	23	36	SCD131-0350-2-2-140HA05-HU630	30391331
3,70*	6	66	28	23	36	SCD131-0370-2-2-140HA05-HU630	30391333
3,90	6	74	36	29	36	SCD131-0390-2-2-140HA05-HU630	30391335
4,00	6	74	36	29	36	SCD131-0400-2-2-140HA05-HU630	30391336
4,10	6	74	36	29	36	SCD131-0410-2-2-140HA05-HU630	30391337
4,20	6	74	36	29	36	SCD131-0420-2-2-140HA05-HU630	30391338
4,30	6	74	36	29	36	SCD131-0430-2-2-140HA05-HU630	30391339
4,50	6	74	36	29	36	SCD131-0450-2-2-140HA05-HU630	30391341
4,60	6	74	36	29	36	SCD131-0460-2-2-140HA05-HU630	30391342
4,70	6	74	36	29	36	SCD131-0470-2-2-140HA05-HU630	30391343
5,00	6	82	44	35	36	SCD131-0500-2-2-140HA05-HU630	30391346
5,10	6	82	44	35	36	SCD131-0510-2-2-140HA05-HU630	30391347
5,20	6	82	44	35	36	SCD131-0520-2-2-140HA05-HU630	30391348
5,50	6	82	44	35	36	SCD131-0550-2-2-140HA05-HU630	30391351
5,60	6	82	44	35	36	SCD131-0560-2-2-140HA05-HU630	30391352
6,00	6	82	44	35	36	SCD131-0600-2-2-140HA05-HU630	30391356
6,10	8	91	53	43	36	SCD131-0610-2-2-140HA05-HU630	30391357
6,20	8	91	53	43	36	SCD131-0620-2-2-140HA05-HU630	30391358
6,30	8	91	53	43	36	SCD131-0630-2-2-140HA05-HU630	30391359
6,40	8	91	53	43	36	SCD131-0640-2-2-140HA05-HU630	30391360
6,50	8	91	53	43	36	SCD131-0650-2-2-140HA05-HU630	30391361
6,60	8	91	53	43	36	SCD131-0660-2-2-140HA05-HU630	30391362
6,80	8	91	53	43	36	SCD131-0680-2-2-140HA05-HU630	30391364
7,00	8	91	53	43	36	SCD131-0700-2-2-140HA05-HU630	30391366
7,40	8	91	53	43	36	SCD131-0740-2-2-140HA05-HU630	30391370
7,50	8	91	53	43	36	SCD131-0750-2-2-140HA05-HU630	30391371
7,60	8	91	53	43	36	SCD131-0760-2-2-140HA05-HU630	30391372
8,00	8	91	53	43	36	SCD131-0800-2-2-140HA05-HU630	30391376
8,40	10	103	61	49	40	SCD131-0840-2-2-140HA05-HU630	30391380
8,50	10	103	61	49	40	SCD131-0850-2-2-140HA05-HU630	30391381
8,73	10	103	61	49	40	SCD131-0873-2-2-140HA05-HU630	30451167
8,90	10	103	61	49	40	SCD131-0890-2-2-140HA05-HU630	30391385

MEGA-Drill-Alu | Solid carbide twist drill SCD131 (5xD), internal coolant supply

Dimensions						Shank form HA	
d ₁ m7	d ₂ h6	l ₁	l ₂	l ₃	l ₄	Specification	Order no.
9,00	10	103	61	49	40	SCD131-0900-2-2-140HA05-HU630	30391386
9,20	10	103	61	49	40	SCD131-0920-2-2-140HA05-HU630	30391388
9,30*	10	103	61	49	40	SCD131-0930-2-2-140HA05-HU630	30391389
9,50	10	103	61	49	40	SCD131-0950-2-2-140HA05-HU630	30391391
9,60	10	103	61	49	40	SCD131-0960-2-2-140HA05-HU630	30391392
10,00	10	103	61	49	40	SCD131-1000-2-2-140HA05-HU630	30391396
10,20	12	118	71	56	45	SCD131-1020-2-2-140HA05-HU630	30391398
10,50	12	118	71	56	45	SCD131-1050-2-2-140HA05-HU630	30391401
10,80	12	118	71	56	45	SCD131-1080-2-2-140HA05-HU630	30391404
11,00	12	118	71	56	45	SCD131-1100-2-2-140HA05-HU630	30391406
11,50	12	118	71	56	45	SCD131-1150-2-2-140HA05-HU630	30391407
12,00	12	118	71	56	45	SCD131-1200-2-2-140HA05-HU630	30391408
12,50	14	124	77	60	45	SCD131-1250-2-2-140HA05-HU630	30391409
13,50	14	124	77	60	45	SCD131-1350-2-2-140HA05-HU630	30391411
14,00	14	124	77	60	45	SCD131-1400-2-2-140HA05-HU630	30391412
16,00	16	133	83	63	48	SCD131-1600-2-2-140HA05-HU630	30391418
20,00	20	153	101	77	50	SCD131-2000-2-2-140HA05-HU630	30446886

Configurable features

**Diameter:**

Diameter in increments of 0.01 mm freely selectable

**Shank form:**

Shank form: HB | HE

Specification:

SCD131-[diameter]-2-2-140[shank form]05-HU630

Dimensions of configurable series

d ₁ min.	d ₁ max.	d ₂ h6	l ₁	l ₂	l ₃	l ₄
2,80	3,70	6	66	28	23	36
3,71	4,70	6	74	36	29	36
4,71	6,00	6	82	44	35	36
6,01	8,00	8	91	53	43	36
8,01	10,00	10	103	61	49	40
10,01	12,00	12	118	71	56	45
12,01	14,00	14	124	77	60	45
14,01	16,00	16	133	83	63	48
16,01	18,00	18	143	93	71	48
18,01	20,00	20	153	101	77	50

Example:

SCD131-0431-2-2-140HE05-HU630

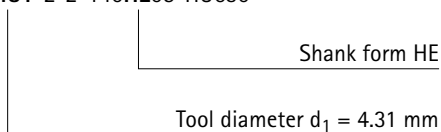

Dimensions in mm.

* Particularly suitable for the premanufacturing of core bores for thread formers.

For cutting data recommendations, see end of chapter.

Special designs and other coatings available upon request.

MEGA-Drill-Alu

Solid carbide twist drill
SCD131 (8xD), internal coolant supply

Design:

Drill diameter: 3.00 – 20.00 mm
Bore tolerance: ≥ IT 9
Cutting material: HU630
Number of cutting edges: 2
Number of guiding chamfers: 2
Tip angle: 140°
Helix angle: 30°

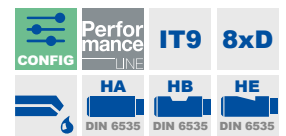
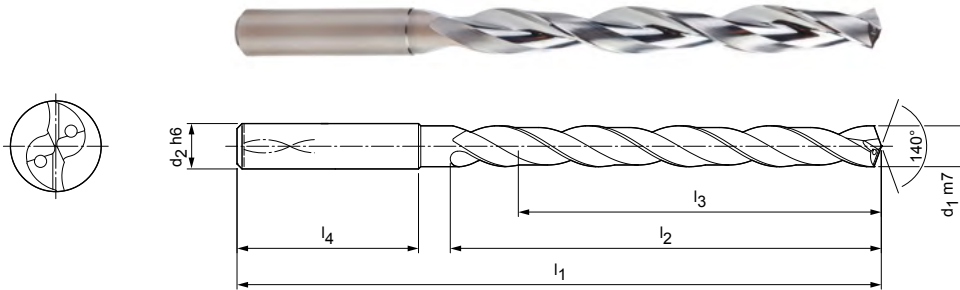

Stocked preferred series in shank form HA

Dimensions						Shank form HA	
d ₁ m7	d ₂ h6	l ₁	l ₂	l ₃	l ₄	Specification	Order no.
3,00	6	72	34	29	36	SCD131-0300-2-2-140HA08-HU630	30391421
3,30	6	72	34	29	36	SCD131-0330-2-2-140HA08-HU630	30391424
3,50	6	72	34	29	36	SCD131-0350-2-2-140HA08-HU630	30391426
3,70	6	72	34	29	36	SCD131-0370-2-2-140HA08-HU630	30391428
4,00	6	81	43	36	36	SCD131-0400-2-2-140HA08-HU630	30391431
4,50	6	81	43	36	36	SCD131-0450-2-2-140HA08-HU630	30391436
5,00	6	95	57	48	36	SCD131-0500-2-2-140HA08-HU630	30391441
5,50	6	95	57	48	36	SCD131-0550-2-2-140HA08-HU630	30391446
6,50	8	114	76	64	36	SCD131-0650-2-2-140HA08-HU630	30391457
6,80	8	114	76	64	36	SCD131-0680-2-2-140HA08-HU630	30391460
7,00	8	114	76	64	36	SCD131-0700-2-2-140HA08-HU630	30391462
8,00	8	114	76	64	36	SCD131-0800-2-2-140HA08-HU630	30391472
9,30	10	142	95	80	40	SCD131-0930-2-2-140HA08-HU630	30391484
11,00	12	162	114	96	45	SCD131-1100-2-2-140HA08-HU630	30391500
12,00	12	162	114	96	45	SCD131-1200-2-2-140HA08-HU630	30391510

Configurable features

Diameter:
Diameter in increments of 0.01 mm freely selectable

Shank form:
Shank form: HB | HE

Specification:
SCD131-[diameter]-2-2-140[shank form]08-HU630

Dimensions of configurable series

d ₁ min.	d ₁ max.	d ₂ h6	l ₁	l ₂	l ₃	l ₄
3,00	3,70	6	72	34	29	36
3,71	4,70	6	81	43	36	36
4,71	6,00	6	95	57	48	36
6,01	8,00	8	114	76	64	36
8,01	10,00	10	142	95	80	40
10,01	12,00	12	162	114	96	45
12,01	14,00	14	178	133	112	45
14,01	16,00	16	203	152	128	48
16,01	18,00	18	222	171	144	48
18,01	20,00	20	243	190	160	50

Example:

SCD131-0431-2-2-140HE08-HU630

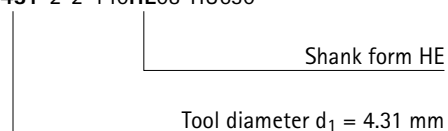

Dimensions in mm.
For cutting data recommendations, see end of chapter.
Special designs and other coatings available upon request.

MEGA-Drill-Alu

Solid carbide twist drill
SCD131 (12xD), internal coolant supply

Design:
 Drill diameter: 3.00 – 20.00 mm
 Bore tolerance: ≥ IT 9
 Cutting material: HU630
 Number of cutting edges: 2
 Number of guiding chamfers: 2
 Tip angle: 140°
 Helix angle: 30°

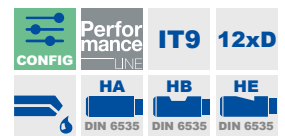
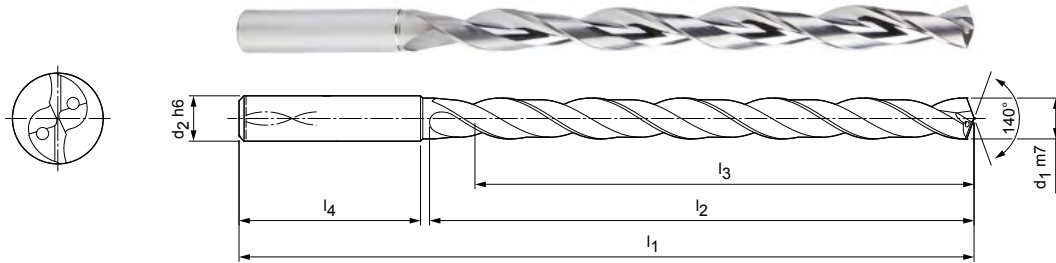

Stocked preferred series in shank form HA

Dimensions						Shank form HA	
d ₁ m7	d ₂ h6	l ₁	l ₂	l ₃	l ₄	Specification	Order no.
3,00	6	92	54	48	36	SCD131-0300-2-2-140HA12-HU630	30391519
3,50	6	92	54	48	36	SCD131-0350-2-2-140HA12-HU630	30391524
4,00	6	102	64	58	36	SCD131-0400-2-2-140HA12-HU630	30391529
4,70	6	102	64	58	36	SCD131-0470-2-2-140HA12-HU630	30391536
5,00	6	116	78	70	36	SCD131-0500-2-2-140HA12-HU630	30391539
5,40	6	116	78	70	36	SCD131-0540-2-2-140HA12-HU630	30391543
5,50	6	116	78	70	36	SCD131-0550-2-2-140HA12-HU630	30391544
5,60	6	116	78	70	36	SCD131-0560-2-2-140HA12-HU630	30391545
6,00	6	116	78	70	36	SCD131-0600-2-2-140HA12-HU630	30391549
6,50	8	146	108	94	36	SCD131-0650-2-2-140HA12-HU630	30391554
6,60	8	146	108	94	36	SCD131-0660-2-2-140HA12-HU630	30391555
7,00	8	146	108	94	36	SCD131-0700-2-2-140HA12-HU630	30391558
8,00	8	146	108	94	36	SCD131-0800-2-2-140HA12-HU630	30391568
9,00	10	162	120	110	40	SCD131-0900-2-2-140HA12-HU630	30391577

Configurable features

Diameter:
Diameter in increments of 0.01 mm freely selectable

Shank form:
Shank form: HB | HE

Specification:
SCD131-[diameter]-2-2-140[shank form]12-HU630

Dimensions of configurable series

d ₁ min.	d ₁ max.	d ₂ h6	l ₁	l ₂	l ₃	l ₄
3,00	3,70	6	92	54	48	36
3,71	4,70	6	102	64	58	36
4,71	6,00	6	116	78	70	36
6,01	8,00	8	146	108	94	36
8,01	10,00	10	162	120	110	40
10,01	12,00	12	204	156	142	45
12,01	14,00	14	230	182	166	45
14,01	16,00	16	260	208	192	48
16,01	18,00	18	285	234	216	48
18,01	20,00	20	310	258	240	50

Example:
SCD131-0431-2-2-140HE12-HU630

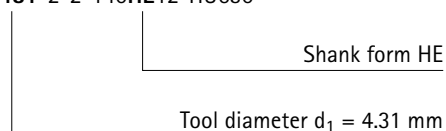

Dimensions in mm.
For cutting data recommendations, see end of chapter.
Special designs and other coatings available upon request.

MEGA-Drill-Composite-MD

Solid carbide twist drill

SCD250 (5xD), external coolant supply

Design:

Drill diameter: 0.50 – 12.00 mm

Cutting material: HC611/619/620

Number of cutting edges: 2

Number of guiding chamfers: 2

Tip angle: 90°

Helix angle: 35°

Application:

CFRP with multidirectional fibres.

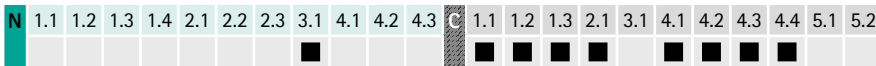
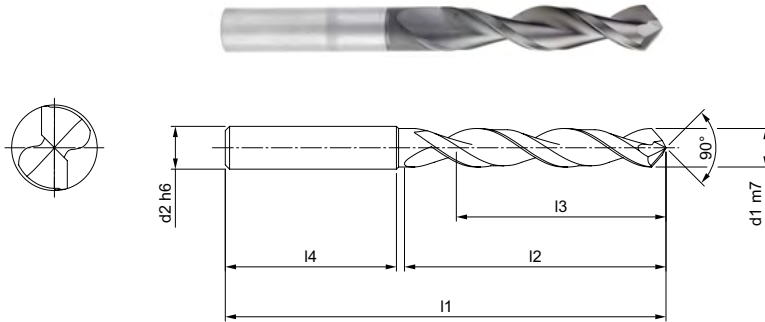

Dimensions						Shank form HA	
d ₁ m7	d ₂ h6	l ₁	l ₂	l ₃	l ₄	Specification	Order no.
0,50	3	55	4,5	3	46	SCD250-0050-2-2-140HA05-HC620	30504673
2,00	3	68	14	11	51	SCD250-0200-2-2-140HA05-HC620	30504688
2,50	3	74	18	14	54	SCD250-0250-2-2-140HA05-HC620	30504693
3,00	6	66	28	23	36	SCD250-0300-2-2-090HA05-HC619	30401902
3,10	6	66	28	23	36	SCD250-0310-2-2-090HA05-HC619	30401903
3,20	6	66	28	23	36	SCD250-0320-2-2-090HA05-HC619	30401905
3,30	6	66	28	23	36	SCD250-0330-2-2-090HA05-HC619	30401906
3,80	6	66	28	23	36	SCD250-0380-2-2-090HA05-HC619	30401911
4,00	6	74	36	29	36	SCD250-0400-2-2-090HA05-HC619	30401913
4,10	6	74	36	29	36	SCD250-0410-2-2-090HA05-HC619	30401914
4,20	6	74	36	29	36	SCD250-0420-2-2-090HA05-HC619	30401915
4,30	6	74	36	29	36	SCD250-0430-2-2-090HA05-HC619	30401916
4,50	6	74	36	29	36	SCD250-0450-2-2-090HA05-HC619	30401918
4,80	6	74	36	29	36	SCD250-0480-2-2-090HA05-HC619	30401922
4,86	6	74	36	0	36	SCD250-0486-2-2-090HA05-HC619	30681789
5,00	6	82	44	35	36	SCD250-0500-2-2-090HA05-HC619	30401924
5,10	6	82	44	35	36	SCD250-0510-2-2-090HA05-HC619	30401925
5,20	6	82	44	35	36	SCD250-0520-2-2-090HA05-HC619	30401926
5,30	6	82	44	35	36	SCD250-0530-2-2-090HA05-HC619	30401927
5,50	6	82	44	35	36	SCD250-0550-2-2-090HA05-HC619	30401929
5,60	6	82	44	35	36	SCD250-0560-2-2-090HA05-HC619	30401930
5,80	6	82	44	35	36	SCD250-0580-2-2-090HA05-HC619	30401932
6,00	6	82	44	35	36	SCD250-0600-2-2-090HA05-HC619	30401934
6,50	8	91	53	43	36	SCD250-0650-2-2-090HA05-HC619	30401940
6,80	8	91	53	43	36	SCD250-0680-2-2-090HA05-HC619	30401943
7,00	8	91	53	43	36	SCD250-0700-2-2-090HA05-HC619	30401945
7,20	8	91	53	43	36	SCD250-0720-2-2-090HA05-HC619	30401947
7,50	8	91	53	43	36	SCD250-0750-2-2-090HA05-HC619	30401950
7,80	8	91	53	43	36	SCD250-0780-2-2-090HA05-HC619	30401953
8,00	8	91	53	43	36	SCD250-0800-2-2-090HA05-HC619	30401956
8,50	10	103	61	49	40	SCD250-0850-2-2-090HA05-HC611	30401961
8,80	10	103	61	49	40	SCD250-0880-2-2-090HA05-HC611	30401964
10,00	10	103	61	49	40	SCD250-1000-2-2-090HA05-HC611	30401977

MEGA-Drill-Composite-MD | Solid carbide twist drill SCD250 (5xD), external coolant supply

Dimensions						Shank form HA	
d ₁ m7	d ₂ h6	l ₁	l ₂	l ₃	l ₄	Specification	Order no.
10,10	12	118	71	56	45	SCD250-1010-2-2-090HA05-HC611	30401978
10,40	12	118	71	56	45	SCD250-1040-2-2-090HA05-HC611	30401981
10,70	12	118	71	56	45	SCD250-1070-2-2-090HA05-HC611	30401984
12,00	12	118	71	56	45	SCD250-1200-2-2-090HA05-HC611	30401998

Configurable features

**Diameter:**

Diameter in increments of 0.01 mm freely selectable

**Shank form:**

Shank form: HB | HE

Specification:

SCD250-[diameter]-2-2-090[shank form]05-HC611

Dimensions of configurable series

d ₁ min.	d ₁ max.	d ₂ h6	l ₁	l ₂	l ₃	l ₄
3,00	3,99	6	66	28	23	36
4,00	4,99	6	74	36	29	36
5,00	6,00	6	82	44	35	36
6,01	8,00	8	91	53	43	36
8,01	10,00	10	103	61	49	40
10,01	12,00	12	118	71	56	45

Example:

SCD250-0431-2-2-090HE05-HC611

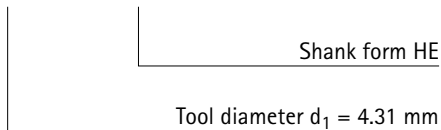

Dimensions in mm.

For cutting data recommendations, see end of chapter.

Special designs and other coatings available upon request.

MEGA-Drill-Composite-UDX

Solid carbide twist drill
SCD270 (5xD), external coolant supply

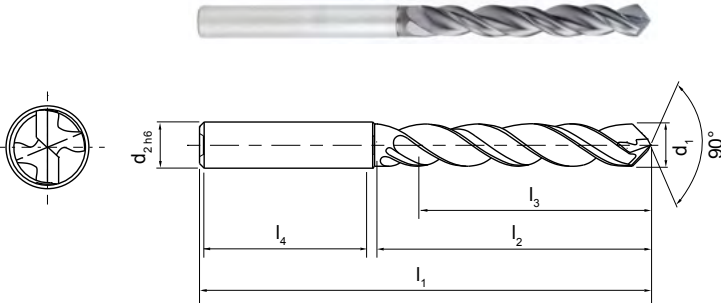

Design:

- Drill diameter: 3.00 – 12.00 mm
- Bore tolerance: ≥ IT 8
- Cutting material: HC619
- Number of cutting edges: 2
- Number of guiding chamfers: 4
- Tip angle: 90°
- Helix angle: 35°

Application:

For all CFRP workpiece materials / problem solver in unstable clamping situations or for thin-walled parts.



Stocked preferred series in shank form HA

Dimensions						Shank form HA	
d ₁ m7	d ₂ h6	l ₁	l ₂	l ₃	l ₄	Specification	Order no.
3,30	6	66	26	20	36	SCD270-0330-2-2-090HA05-HC619	30402105
4,00	6	74	35	27	36	SCD270-0400-2-2-090HA05-HC619	30402112
4,394	6	74	35	27	36	SCD270-04394-2-2-090HA05-HC619	30634827
4,50	6	74	35	27	36	SCD270-0450-2-2-090HA05-HC619	30402117
5,00	6	82	44	35	36	SCD270-0500-2-2-090HA05-HC619	30402123

Configurable features

Diameter:
Diameter in increments of 0.01 mm freely selectable

Shank form:
Shank form: HB | HE

Specification:
SCD270-[diameter]-2-2-090[shank form]05-HC619

Dimensions of configurable series

d ₁ min.	d ₁ max.	d ₂ h6	l ₁	l ₂	l ₃	l ₄
3,00	3,99	6	66	26	20	36
4,00	4,99	6	74	35	27	36
5,00	6,00	6	82	44	35	36
6,01	8,00	8	91	52	40	36
8,01	10,00	10	103	60	45	40
10,01	12,00	12	118	70	52	45

Example:

SCD270-0431-2-2-090HE05-HC619

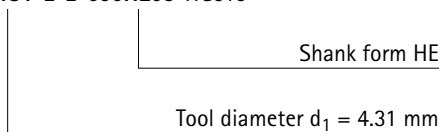

Dimensions in mm.

For cutting data recommendations, see end of chapter.

Special designs and other coatings available upon request.

MEGA-Drill-Composite-UDX

Solid carbide twist drill
SCD271 (5xD), internal coolant supply

Design:
 Drill diameter: 6.00 - 12.00
 Cutting material: HC619
 Number of cutting edges: 2
 Number of guiding chamfers: 3
 Tip angle: 90°
 Helix angle: 35°

Application:
 For all CFRP workpiece materials / problem solver
 in unstable clamping situations or for thin-walled parts.

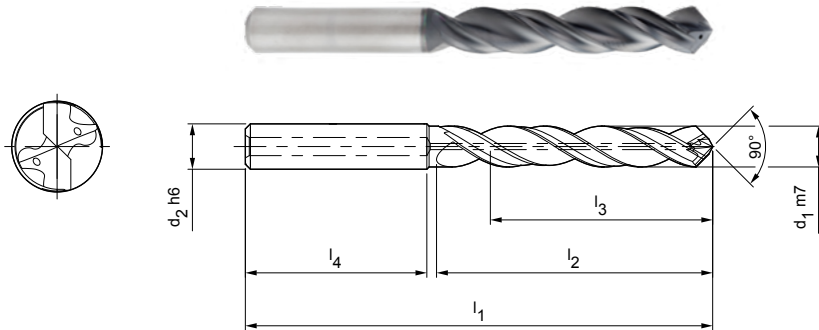

N	1.1	1.2	1.3	1.4	2.1	2.2	2.3	3.1	4.1	4.2	4.3	C	1.1	1.2	1.3	2.1	3.1	4.1	4.2	5.1	5.2	5.3
---	-----	-----	-----	-----	-----	-----	-----	-----	-----	-----	-----	---	-----	-----	-----	-----	-----	-----	-----	-----	-----	-----



Stocked preferred series in shank form HA

Dimensions						Shank form HA	
d ₁ m7	d ₂ h6	l ₁	l ₂	l ₃	l ₄	Specification	Order no.
6,00	6	82	44	35	36	SCD271-0600-2-2-090HA05-HC619	30402197
8,00	8	91	52	40	36	SCD271-0800-2-2-090HA05-HC619	30402219
10,00	10	103	60	45	40	SCD271-1000-2-2-090HA05-HC611	30402240

Configurable features



Diameter:
 Diameter in increments of 0.01 mm freely selectable



Shank form:
 Shank form: HB | HE

Specification:

SCD271-[diameter]-2-2-090[shank form]05-HC619

Dimensions of configurable series

d ₁ min.	d ₁ max.	d ₂ h6	l ₁	l ₂	l ₃	l ₄
6,00	6,00	6	82	44	35	36
6,01	8,00	8	91	52	40	36
8,01	10,00	10	103	60	45	40
10,01	12,00	12	118	70	52	45

Example:

SCD271-0431-2-2-090HE05-HC619

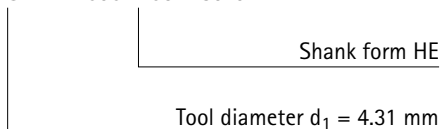

Dimensions in mm.

For cutting data recommendations, see end of chapter.

Special designs and other coatings available upon request.

MEGA-180°-Drill-Alu

Solid carbide twist drill
SCD241 (3xD), internal coolant supply

Design:
 Drill diameter: 3.00 – 20.00 mm
 Bore tolerance: \geq IT 9
 Cutting material: HU630
 Number of cutting edges: 2
 Number of guiding chamfers: 4
 Tip angle: 180°
 Helix angle: 30°

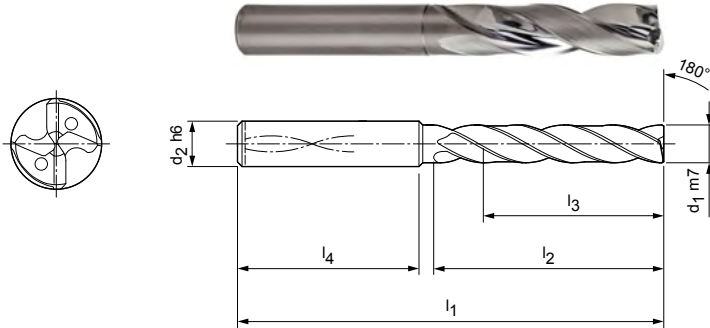

Stocked preferred series in shank form HA

Dimensions						Shank form HA	
d ₁ m7	d ₂ h6	l ₁	l ₂	l ₃	l ₄	Specification	Order no.
3,00	6	62	20	14	36	SCD241-0300-2-4-180HA03-HU630	30382883
3,70	6	62	20	14	36	SCD241-0370-2-4-180HA03-HU630	30382890
4,00	6	66	24	17	36	SCD241-0400-2-4-180HA03-HU630	30382893
4,20	6	66	24	17	36	SCD241-0420-2-4-180HA03-HU630	30382895
4,30	6	66	24	17	36	SCD241-0430-2-4-180HA03-HU630	30382896
4,60	6	66	24	17	36	SCD241-0460-2-4-180HA03-HU630	30382899
5,00	6	66	28	20	36	SCD241-0500-2-4-180HA03-HU630	30382904
5,50	6	66	28	20	36	SCD241-0550-2-4-180HA03-HU630	30382909
5,56	6	66	28	20	36	SCD241-0556-2-4-180HA03-HU630	30463897
6,00	6	66	28	20	36	SCD241-0600-2-4-180HA03-HU630	30382915
6,50	8	79	34	24	36	SCD241-0650-2-4-180HA03-HU630	30382920
6,70	8	79	34	24	36	SCD241-0670-2-4-180HA03-HU630	30382922
7,00	8	79	34	24	36	SCD241-0700-2-4-180HA03-HU630	30382925
7,20	8	79	41	29	36	SCD241-0720-2-4-180HA03-HU630	30382927
7,40	8	79	41	29	36	SCD241-0740-2-4-180HA03-HU630	30382929
7,50	8	79	41	29	36	SCD241-0750-2-4-180HA03-HU630	30382930
7,80	8	79	41	29	36	SCD241-0780-2-4-180HA03-HU630	30382933
8,00	8	79	41	29	36	SCD241-0800-2-4-180HA03-HU630	30382935
8,50	10	89	47	35	40	SCD241-0850-2-4-180HA03-HU630	30382940
8,90	10	89	47	35	40	SCD241-0890-2-4-180HA03-HU630	30382944
9,00	10	89	47	35	40	SCD241-0900-2-4-180HA03-HU630	30382945
9,20	10	89	47	35	40	SCD241-0920-2-4-180HA03-HU630	30382947
9,80	10	89	47	35	40	SCD241-0980-2-4-180HA03-HU630	30382953
10,00	10	89	47	35	40	SCD241-1000-2-4-180HA03-HU630	30382955
11,00	12	100	53	38	45	SCD241-1100-2-4-180HA03-HU630	30382965
12,00	12	100	53	38	45	SCD241-1200-2-4-180HA03-HU630	30382975
13,00	14	105	58	41	45	SCD241-1300-2-4-180HA03-HU630	30382978
14,50	16	113	63	43	48	SCD241-1450-2-4-180HA03-HU630	30382982
17,00	18	121	71	49	48	SCD241-1700-2-4-180HA03-HU630	30382990
18,50	20	129	77	53	50	SCD241-1850-2-4-180HA03-HU630	30382994

MEGA-180°-Drill-Alu | Solid carbide twist drill SCD241 (3xD), internal coolant supply

Configurable features

**Diameter:**

Diameter in increments of 0.01 mm freely selectable

**Shank form:**

Shank form: HB | HE

Specification:

SCD241-[diameter]-2-4-180[shank form]03-HU630

Example:

SCD241-0431-2-4-180HE03-HU630

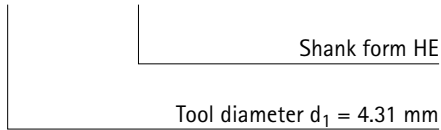

Dimensions of configurable series

d ₁ min.	d ₁ max.	d ₂ h6	l ₁	l ₂	l ₃	l ₄
3,00	3,70	6	62	20	14	36
3,71	4,70	6	66	24	17	36
4,71	6,00	6	66	28	20	36
6,01	6,80	8	79	34	24	36
6,81	8,00	8	79	41	29	36
8,01	10,00	10	89	47	35	40
10,01	12,00	12	100	53	38	45
12,0	14,00	14	105	58	41	45
14,01	16,00	16	113	63	43	48
16,01	18,00	18	121	71	49	48
18,01	20,00	20	129	77	53	50

Dimensions in mm.

For cutting data recommendations, see end of chapter.

Special designs and other coatings available upon request.

MEGA-180°-Drill-Alu

Solid carbide twist drill
SCD241 (5xD), internal coolant supply

Design:
 Drill diameter: 3.00 – 20.00 mm
 Bore tolerance: ≥ IT 9
 Cutting material: HU630
 Number of cutting edges: 2
 Number of guiding chamfers: 4
 Tip angle: 180°
 Helix angle: 30°

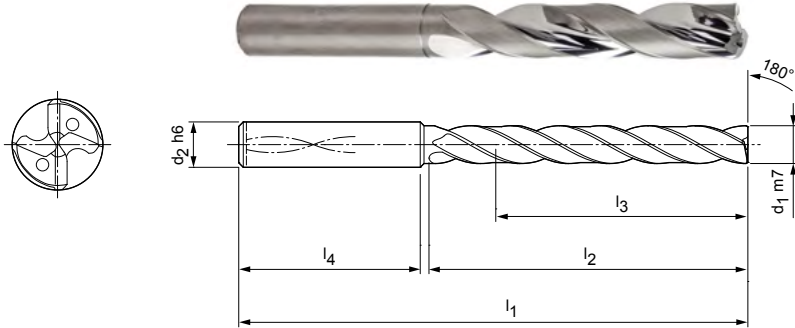

Stocked preferred series in shank form HA

Dimensions						Shank form HA	
d ₁ m7	d ₂ h6	l ₁	l ₂	l ₃	l ₄	Specification	Order no.
3,00	6	66	28	23	36	SCD241-0300-2-4-180HA05-HU630	30383000
3,50	6	66	28	23	36	SCD241-0350-2-4-180HA05-HU630	30383005
4,00	6	74	36	29	36	SCD241-0400-2-4-180HA05-HU630	30383010
4,10	6	74	36	29	36	SCD241-0410-2-4-180HA05-HU630	30383011
4,80	6	82	44	35	36	SCD241-0480-2-4-180HA05-HU630	30383019
5,00	6	82	44	35	36	SCD241-0500-2-4-180HA05-HU630	30383021
5,60	6	82	44	35	36	SCD241-0560-2-4-180HA05-HU630	30383028
6,00	6	82	44	35	36	SCD241-0600-2-4-180HA05-HU630	30383032
6,50	8	91	53	43	36	SCD241-0650-2-4-180HA05-HU630	30383037
7,00	8	91	53	43	36	SCD241-0700-2-4-180HA05-HU630	30383042
7,50	8	91	53	43	36	SCD241-0750-2-4-180HA05-HU630	30383047
8,00	8	91	53	43	36	SCD241-0800-2-4-180HA05-HU630	30383052
8,20	10	103	61	49	40	SCD241-0820-2-4-180HA05-HU630	30383054
8,50	10	103	61	49	40	SCD241-0850-2-4-180HA05-HU630	30383057
9,00	10	103	61	49	40	SCD241-0900-2-4-180HA05-HU630	30383062
9,30	10	103	61	49	40	SCD241-0930-2-4-180HA05-HU630	30383066
10,00	10	103	61	49	40	SCD241-1000-2-4-180HA05-HU630	30383073
12,00	12	116	69	54	45	SCD241-1200-2-4-180HA05-HU630	30383093
13,00	14	122	75	58	45	SCD241-1300-2-4-180HA05-HU630	30383096
14,00	14	122	75	58	45	SCD241-1400-2-4-180HA05-HU630	30383099
15,00	16	131	81	61	48	SCD241-1500-2-4-180HA05-HU630	30383102
15,70	16	131	81	61	48	SCD241-1570-2-4-180HA05-HU630	31237410
20,00	20	151	99	75	50	SCD241-2000-2-4-180HA05-HU630	30383117

MEGA-180°-Drill-Alu | Solid carbide twist drill SCD241 (5xD), internal coolant supply

Configurable features

**Diameter:**

Diameter in increments of 0.01 mm freely selectable

**Shank form:**

Shank form: HB | HE

Specification:

SCD241-[diameter]-2-4-180[shank form]05-HU630

Dimensions of configurable series

d ₁ min.	d ₁ max.	d ₂ h6	l ₁	l ₂	l ₃	l ₄
3,00	3,70	6	66	28	23	36
3,71	4,70	6	74	36	29	36
4,71	6,00	6	82	44	35	36
6,01	8,00	8	91	53	43	36
8,01	10,00	10	103	61	49	40
10,01	12,00	12	116	69	54	45
12,01	14,00	14	122	75	58	45
14,01	16,00	16	131	81	61	48
16,01	18,00	18	141	91	69	48
18,01	20,00	20	151	99	75	50

Example:

SCD241-0431-2-4-180HE05-HU630

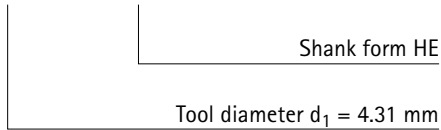

Dimensions in mm.

For cutting data recommendations, see end of chapter.

Special designs and other coatings available upon request.

ECU G Drill

Solid carbide drill, straight fluted
SCD211 (5xD), internal coolant supply

Design:

Drill diameter: 4.80 – 7.50 mm
Bore diameter: ≥ IT 9
Cutting material: HU610
Number of cutting edges: 2
Number of guiding chamfers: 4
Tip angle: 130°

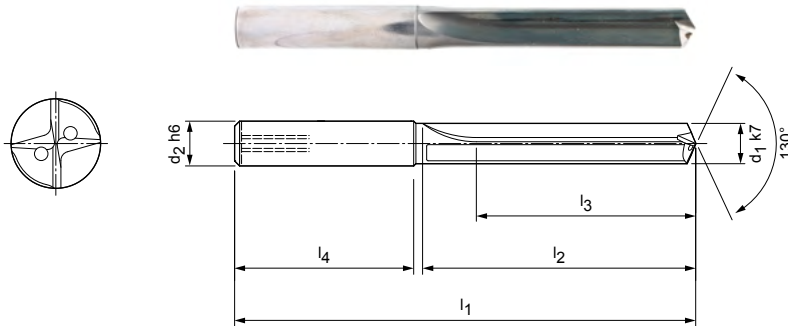

Stocked preferred series in shank form HA

Dimensions						Shank form HA	
d ₁ k7	d ₂ h6	l ₁	l ₂	l ₃	l ₄	Specification	Order no.
4,80	6	82	44	35	36	SCD211-0480-2-4-130HA05-HU610	30392622
5,50	6	82	44	35	36	SCD211-0550-2-4-130HA05-HU610	30392630
5,70	6	82	44	35	36	SCD211-0570-2-4-130HA05-HU610	30392632
5,80	6	82	44	35	36	SCD211-0580-2-4-130HA05-HU610	30392633
6,80	8	91	53	43	36	SCD211-0680-2-4-130HA05-HU610	30392643
7,40	8	91	53	43	36	SCD211-0740-2-4-130HA05-HU610	30392649
7,50	8	91	53	43	36	SCD211-0750-2-4-130HA05-HU610	30392650

Configurable features



Shank form:
Shank form: HB | HE



Specification:

SCD211-0430-2-4-130[shank form]05-HU610

Example:

SCD211-0430-3-3-140HE05-HU610

Shank form HE

Dimensions in mm.

For cutting data recommendations, see end of chapter.

Special designs and other coatings available upon request.

ECU G Drill

Solid carbide drill, straight fluted
SCD211 (8xD), internal coolant supply

Design:

Drill diameter: 5.80 – 11.60 mm
Bore tolerance: ≥ IT 9
Cutting material: HU610
Number of cutting edges: 2
Number of guiding chamfers: 4
Tip angle: 130°

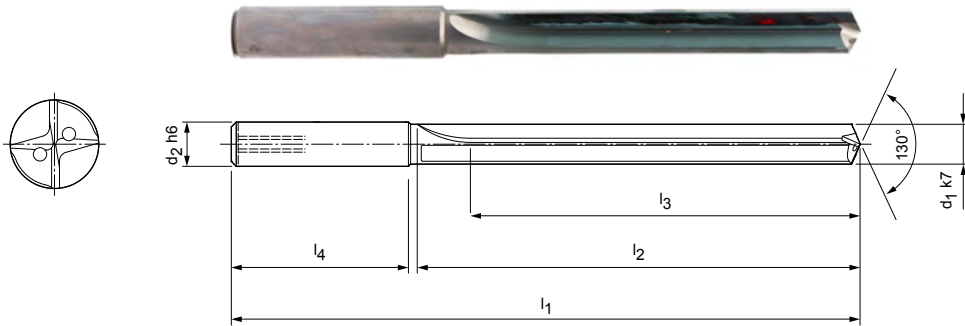

Stocked preferred series in shank form HA

Dimensions						Shank form HA	
d ₁ k7	d ₂ h6	l ₁	l ₂	l ₃	l ₄	Specification	Order no.
5,80	6	95	57	48	36	SCD211-0580-2-4-130HA08-HU610	30392739
11,60	12	162	114	96	45	SCD211-1160-2-4-130HA08-HU610	30392797

Configurable features



Shank form:
Shank form: HB | HE



Specification:
SCD211-0430-2-4-130[shank form]08-HU610

Example:

SCD211-0430-3-3-140HE08-HU610

Shank form HE

Dimensions in mm.

For cutting data recommendations, see end of chapter.

Special designs and other coatings available upon request.

Cutting data recommendations for solid carbide drills

Feed and cutting speed

Tritan-Drill-Uni-Plus | SCD631

MMG*	Workpiece material	Strength/hardness [N/mm ²] [HRC]
P	P1.1 Structural, free-cutting, case hardened and heat-treated steels, non-alloy	< 700
	P1.2 Structural, free-cutting, case hardened and heat-treated steels, non-alloy	< 1,200
	P2.1 Nitrided, case hardened and heat-treated steels, alloy	< 900
	P2.2 Nitrided, case hardened and heat-treated steels, alloy	< 1,400
	P3.1 Tool, bearing, spring and high-speed steels**	< 800
	P3.2 Tool, bearing, spring and high-speed steels**	< 1,000
	P3.3 Tool, bearing, spring and high-speed steels**	< 1,500
	P5.1 Cast steel	
M	M1.1 Stainless steels, austenitic	< 700
	M1.2 Stainless steels, ferritic/austenitic (duplex)	< 1,000
K	K1.1 Cast iron with lamellar graphite (grey cast iron), GJL	< 300
	K2.1 Cast iron with spheroidal graphite, GJS	< 500
	K2.2 Cast iron with spheroidal graphite, GJS	≤ 800
	K2.3 Cast iron with spheroidal graphite, GJS	> 800
	K3.1 Cast iron with spheroidal graphite, GJV; malleable cast iron, GJM	< 500
	K3.2 Cast iron with spheroidal graphite, GJV; malleable cast iron, GJM	> 500
N	N1.1 Aluminium, non-alloy and alloy < 3 % Si	
	N1.2 Aluminium, alloy ≤ 7 % Si	
	N1.3 Aluminium, alloy > 7-12 % Si	
	N1.4 Aluminium, alloy > 12 % Si	
	N2.1 Copper, non-alloy and low-alloy	< 300
	N2.2 Copper, alloy	> 300
	N2.3 Brass, bronze, gunmetal	< 1,200

MEGA-Speed-Drill-Uni | SCD221

MMG*	Workpiece material	Strength/hardness [N/mm ²] [HRC]
P	P1.1 Structural, free-cutting, case hardened and heat-treated steels, non-alloy	< 700
	P1.2 Structural, free-cutting, case hardened and heat-treated steels, non-alloy	< 1,200
	P2.1 Nitrided, case hardened and heat-treated steels, alloy	< 900
	P2.2 Nitrided, case hardened and heat-treated steels, alloy	< 1,400
	P3.1 Tool, bearing, spring and high-speed steels**	< 800
	P3.2 Tool, bearing, spring and high-speed steels**	< 1,000
	P3.3 Tool, bearing, spring and high-speed steels**	< 1,500
	P4.1 Stainless steels, ferritic and martensitic	
	P5.1 Cast steel	
	P6.1 Stainless cast steel, ferritic and martensitic	
K	K1.1 Cast iron with lamellar graphite (grey cast iron), GJL	< 300
	K2.1 Cast iron with spheroidal graphite, GJS	< 500
	K2.2 Cast iron with spheroidal graphite, GJS	≤ 800
	K2.3 Cast iron with spheroidal graphite, GJS	> 800
	K3.1 Cast iron with spheroidal graphite, GJV; malleable cast iron, GJM	< 500
	K3.2 Cast iron with spheroidal graphite, GJV; malleable cast iron, GJM	> 500

* MAPAL machining groups

** If the alloy parts Cr, Mo, Ni, V, W in total > 8% then select the next highest MAPAL machining group.

	Cutting speed v_c [m/min]				Feed f [mm] for drill diameter					
	Internal cooling	External cooling	MQL	Air	4.00	5.50	7.50	10.50	14.50	20.00
	115	105	105		0.22	0.27	0.34	0.42	0.51	0.59
	105	85	85		0.27	0.34	0.42	0.53	0.64	0.74
	115	100	100		0.25	0.32	0.40	0.50	0.60	0.70
	80	70	70		0.21	0.26	0.32	0.40	0.48	0.55
	85	75	75		0.23	0.29	0.36	0.45	0.54	0.63
	70	65	65		0.19	0.24	0.30	0.37	0.44	0.51
	70	50	60		0.16	0.19	0.24	0.29	0.34	0.40
	115	100	100		0.25	0.32	0.40	0.50	0.60	0.70
	55	35	35		0.11	0.14	0.18	0.22	0.27	0.31
	140	100	100	100	0.31	0.41	0.53	0.68	0.84	0.98
	185	115	140	140	0.30	0.39	0.50	0.64	0.78	0.91
	115	85	85		0.27	0.35	0.44	0.55	0.67	0.78
	70	45	60		0.14	0.18	0.22	0.28	0.33	0.38
	105	90	90		0.29	0.37	0.47	0.59	0.72	0.84
	90	80	80		0.25	0.31	0.38	0.48	0.57	0.66
	345	230	290		0.22	0.27	0.34	0.42	0.51	0.59
	290	205	230		0.27	0.35	0.44	0.55	0.67	0.78
	255	175	205		0.27	0.35	0.44	0.55	0.67	0.78
	205	140	175		0.27	0.35	0.44	0.55	0.67	0.78
	140	105			0.20	0.26	0.33	0.41	0.50	0.58
	230	185	185	140	0.31	0.41	0.53	0.68	0.84	0.98

	Cutting speed v_c [m/min]				Feed f [mm] for drill diameter					
	Internal cooling	External cooling	MQL	Air	3.00	4.50	6.50	9.50	14.00	20.00
	170	155	155		0.11	0.14	0.18	0.23	0.30	0.36
	155	130	130		0.14	0.18	0.22	0.29	0.37	0.45
	170	145	145		0.13	0.17	0.21	0.27	0.35	0.43
	120	100	100		0.11	0.14	0.17	0.22	0.28	0.34
	130	110	110		0.11	0.15	0.19	0.25	0.32	0.38
	115	100	95		0.10	0.14	0.17	0.22	0.28	0.35
	100	75	85		0.10	0.13	0.16	0.20	0.26	0.31
	100	75	85		0.08	0.10	0.13	0.16	0.21	0.25
	170	145	145		0.13	0.17	0.21	0.27	0.35	0.43
	100	75	85		0.08	0.10	0.13	0.16	0.21	0.25
	150	105	105	105	0.13	0.19	0.26	0.35	0.45	0.54
	200	125	150	150	0.13	0.18	0.25	0.33	0.42	0.50
	125	95	95		0.12	0.16	0.22	0.28	0.36	0.43
	75	50	65		0.09	0.12	0.15	0.19	0.24	0.28
	115	100	100		0.13	0.18	0.23	0.31	0.39	0.46
	100	90	90		0.11	0.15	0.19	0.25	0.31	0.36

The specified cutting values are guide values.

The optimum data for the respective machining task should be determined during the test or machining.

Cutting data recommendations for solid carbide drills

Feed and cutting speed

ECU-Drill-Uni | SCD350, 351

MMG*		Workpiece material	Strength/hardness [N/mm ²] [HRC]
P	P1	P1.1 Structural, free-cutting, case hardened and heat-treated steels, non-alloy	< 700
		P1.2 Structural, free-cutting, case hardened and heat-treated steels, non-alloy	< 1,200
	P2	P2.1 Nitrided, case hardened and heat-treated steels, alloy	< 900
		P2.2 Nitrided, case hardened and heat-treated steels, alloy	< 1,400
	P3	P3.1 Tool, bearing, spring and high-speed steels**	< 800
		P3.2 Tool, bearing, spring and high-speed steels**	< 1,000
		P3.3 Tool, bearing, spring and high-speed steels**	< 1,500
	P5	P5.1 Cast steel	
M	M1	M1.1 Stainless steels, austenitic	< 700
		M1.2 Stainless steels, ferritic/austenitic (duplex)	< 1,000
	M2	M2.1 Stainless/heat-resistant cast steel, austenitic	< 700
	M3	M3.1 Stainless cast steel, ferritic/austenitic (duplex)	< 1,000
K	K2	K2.1 Cast iron with spheroidal graphite, GJS	< 500
		K2.2 Cast iron with spheroidal graphite, GJS	≤ 800
		K2.3 Cast iron with spheroidal graphite, GJS	> 800

MEGA-Drill-Steel-Plus | SCD600, 601

MMG*		Workpiece material	Strength/hardness [N/mm ²] [HRC]
P	P1	P1.1 Structural, free-cutting, case hardened and heat-treated steels, non-alloy	< 700
		P1.2 Structural, free-cutting, case hardened and heat-treated steels, non-alloy	< 1,200
	P2	P2.1 Nitrided, case hardened and heat-treated steels, alloy	< 900
		P2.2 Nitrided, case hardened and heat-treated steels, alloy	< 1,400
	P3	P3.1 Tool, bearing, spring and high-speed steels**	< 800
		P3.2 Tool, bearing, spring and high-speed steels**	< 1,000
		P3.3 Tool, bearing, spring and high-speed steels**	< 1,500
	P4	P4.1 Stainless steels, ferritic and martensitic	
	P5	P5.1 Cast steel	
	P6	P6.1 Stainless cast steel, ferritic and martensitic	
K	K1	K1.1 Cast iron with lamellar graphite (grey cast iron), GJL	< 300
		K2.1 Cast iron with spheroidal graphite, GJS	< 500
	K2	K2.2 Cast iron with spheroidal graphite, GJS	≤ 800
		K2.3 Cast iron with spheroidal graphite, GJS	> 800
	K3	K3.1 Cast iron with spheroidal graphite, GJV; malleable cast iron, GJM	< 500
		K3.2 Cast iron with spheroidal graphite, GJV; malleable cast iron, GJM	> 500
H	H1	H1.1 Hardened steel/cast steel	< 44
		H1.2 Hardened steel/cast steel	< 55

* MAPAL machining groups

** If the alloy parts Cr, Mo, Ni, V, W in total > 8% then select the next highest MAPAL machining group.

	Cutting speed v_c [m/min]				Feed f [mm] for drill diameter					
	Internal cooling	External cooling	MQL	Air	1.00	1.82	3.31	6.03	10.99	20.00
	75	70	70		0.03	0.05	0.07	0.10	0.16	0.21
	70	55	55		0.04	0.06	0.08	0.13	0.20	0.27
	75	65	65		0.04	0.05	0.08	0.12	0.18	0.25
	55	45	45		0.04	0.05	0.07	0.10	0.15	0.20
	55	50	50		0.03	0.05	0.07	0.11	0.17	0.23
	45	40	40		0.03	0.04	0.06	0.09	0.14	0.18
	45	35	40		0.03	0.04	0.05	0.07	0.11	0.14
	75	65	65		0.04	0.05	0.08	0.12	0.18	0.25
	45	30	30		0.03	0.04	0.06	0.09	0.14	0.19
	45	25	25		0.02	0.03	0.05	0.08	0.12	0.16
	45	30	30		0.03	0.04	0.06	0.09	0.14	0.19
	45	25	25		0.02	0.03	0.05	0.08	0.12	0.16
	120	75	90	90	0.05	0.07	0.12	0.19	0.30	0.41
	75	55	55		0.04	0.07	0.11	0.17	0.26	0.35

	Cutting speed v_c [m/min]				Feed f [mm] for drill diameter					
	Internal cooling	External cooling	MQL	Air	3.00	4.50	6.50	9.50	14.00	20.00
	110	100	100		0.10	0.13	0.17	0.22	0.28	0.33
	100	85	85		0.12	0.16	0.21	0.27	0.34	0.41
	110	95	95		0.11	0.15	0.20	0.26	0.33	0.38
	75	65	65		0.10	0.13	0.16	0.21	0.26	0.30
	85	70	70		0.10	0.14	0.18	0.23	0.29	0.35
	65	60	60		0.09	0.12	0.15	0.19	0.24	0.28
	65	50	55		0.07	0.09	0.12	0.15	0.19	0.22
	65	50	55		0.07	0.09	0.12	0.15	0.19	0.23
	110	95	95		0.11	0.15	0.20	0.26	0.33	0.38
	65	50	55		0.07	0.09	0.12	0.15	0.19	0.23
	120	85	85	85	0.13	0.19	0.26	0.35	0.45	0.54
	160	100	120	120	0.13	0.18	0.25	0.33	0.42	0.50
	100	75	75		0.12	0.16	0.22	0.28	0.36	0.43
	60	40	50		0.09	0.12	0.15	0.19	0.24	0.28
	90	80	80		0.13	0.18	0.23	0.31	0.39	0.46
	80	70	70		0.11	0.15	0.19	0.25	0.31	0.36
	90	90	90		0.09	0.12	0.15	0.19	0.24	0.28
	25	25	25		0.05	0.06	0.08	0.11	0.14	0.16

The specified cutting values are guide values.

The optimum data for the respective machining task should be determined during the test or machining.

Cutting data recommendations for solid carbide drills

Feed and cutting speed

MEGA-Quadro-Drill-Plus | SCD610, 611

MMG*	Workpiece material		Strength/hardness [N/mm ²] [HRC]
P	P1	P1.1 Structural, free-cutting, case hardened and heat-treated steels, non-alloy	< 700
		P1.2 Structural, free-cutting, case hardened and heat-treated steels, non-alloy	< 1200
	P2	P2.1 Nitrided, case hardened and heat-treated steels, alloy	< 900
		P2.2 Nitrided, case hardened and heat-treated steels, alloy	< 1400
	P3	P3.1 Tool, bearing, spring and high-speed steels**	< 800
		P3.2 Tool, bearing, spring and high-speed steels**	< 1000
		P3.3 Tool, bearing, spring and high-speed steels**	< 1500
	P5	P5.1 Cast steel	
K	K1	K1.1 Cast iron with lamellar graphite (grey cast iron), GJL	< 300
		K2.1 Cast iron with spheroidal graphite, GJS	< 500
	K2	K2.2 Cast iron with spheroidal graphite, GJS	≤ 800
		K2.3 Cast iron with spheroidal graphite, GJS	> 800
	K3	K3.1 Cast iron with spheroidal graphite, GJV; malleable cast iron, GJM	< 500
		K3.2 Cast iron with spheroidal graphite, GJV; malleable cast iron, GJM	> 500

MICRO-Drill-Steel | SCD371

MMG*	Workpiece material		Strength/hardness [N/mm ²] [HRC]
P	P1	P1.1 Structural, free-cutting, case hardened and heat-treated steels, non-alloy	< 700
		P1.2 Structural, free-cutting, case hardened and heat-treated steels, non-alloy	< 1200
	P2	P2.1 Nitrided, case hardened and heat-treated steels, alloy	< 900
		P2.2 Nitrided, case hardened and heat-treated steels, alloy	< 1400
	P3	P3.1 Tool, bearing, spring and high-speed steels**	< 800
		P3.2 Tool, bearing, spring and high-speed steels**	< 1000
		P3.3 Tool, bearing, spring and high-speed steels**	< 1500
	P5	P5.1 Cast steel	
M	M1	M1.1 Stainless steels, austenitic	< 700
		M1.2 Stainless steels, ferritic/austenitic (duplex)	< 1000
K	K1	K1.1 Cast iron with lamellar graphite (grey cast iron), GJL	< 300
		K2.1 Cast iron with spheroidal graphite, GJS	< 500
	K2	K2.2 Cast iron with spheroidal graphite, GJS	≤ 800
		K2.3 Cast iron with spheroidal graphite, GJS	> 800
	K3	K3.1 Cast iron with spheroidal graphite, GJV; malleable cast iron, GJM	< 500
		K3.2 Cast iron with spheroidal graphite, GJV; malleable cast iron, GJM	> 500

MEGA-Drill-Hardened | SCD141

MMG*	Workpiece material		Strength/hardness [N/mm ²] [HRC]
H	H1	H1.1 Hardened steel/cast steel	< 44
		H1.2 Hardened steel/cast steel	< 55
	H2	H2.1 Hardened steel/cast steel	< 60
		H2.2 Hardened steel/cast steel	< 65
		H2.3 Hardened steel/cast steel	< 68

* MAPAL machining groups

** If the alloy parts Cr, Mo, Ni, V, W in total > 8% then select the next highest MAPAL machining group.

	Cutting speed v_c [m/min]				Feed f [mm] for drill diameter					
	Internal cooling	External cooling	MQL	Air	4.00	5.50	7.50	10.50	14.50	20.00
	110	100	100		0.10	0.13	0.17	0.22	0.28	0.33
	100	85	85		0.12	0.16	0.21	0.27	0.34	0.41
	110	95	95		0.11	0.15	0.20	0.26	0.33	0.38
	75	65	65		0.10	0.13	0.16	0.21	0.26	0.30
	85	70	70		0.10	0.14	0.18	0.23	0.29	0.35
	65	60	60		0.09	0.12	0.15	0.19	0.24	0.28
	65	50	55		0.07	0.09	0.12	0.15	0.19	0.22
	110	95	95		0.11	0.15	0.20	0.26	0.33	0.38
	130	95	95	95	0.13	0.19	0.26	0.35	0.45	0.54
	175	110	130	130	0.13	0.18	0.25	0.33	0.42	0.50
	110	85	85		0.12	0.16	0.22	0.28	0.36	0.43
	65	45	55		0.09	0.12	0.15	0.19	0.24	0.28
	100	90	90		0.13	0.18	0.23	0.31	0.39	0.46
	90	75	75		0.11	0.15	0.19	0.25	0.31	0.36

	Cutting speed v_c [m/min]				Feed f [mm] for drill diameter					
	Internal cooling	External cooling	MQL	Air	4.00	5.50	7.50	10.50	14.50	20.00
	80	70	70		0.04	0.04	0.05	0.06	0.07	0.08
	70	60	60		0.04	0.05	0.06	0.07	0.08	0.10
	80	70	70		0.04	0.05	0.06	0.07	0.08	0.09
	55	50	50		0.04	0.05	0.05	0.06	0.07	0.08
	60	50	50		0.04	0.04	0.05	0.06	0.07	0.08
	50	45	45		0.04	0.04	0.04	0.05	0.06	0.07
	50	35	40		0.03	0.04	0.04	0.05	0.05	0.06
	80	70	70		0.04	0.05	0.06	0.07	0.08	0.09
	40	25	25		0.03	0.03	0.03	0.04	0.05	0.06
	95	70	70	70	0.03	0.04	0.05	0.06	0.08	0.11
	130	80	95	95	0.04	0.05	0.06	0.07	0.09	0.11
	80	60	60		0.04	0.05	0.05	0.07	0.08	0.10
	70	65	65		0.04	0.05	0.06	0.07	0.09	0.11
65	55	55		0.04	0.05	0.06	0.07	0.08	0.09	

	Cutting speed v_c [m/min]				Feed f [mm] for drill diameter					
	Internal cooling	External cooling	MQL	Air	2.50	3.62	5.25	7.61	11.04	16.00
	80	80	80		0.07	0.09	0.11	0.02	0.19	0.20
	30	30	30		0.05	0.06	0.08	0.10	0.13	0.16
		30	30		0.04	0.05	0.07	0.09	0.11	0.13
		20	20		0.03	0.04	0.05	0.06	0.08	0.09
		15	15		0.03	0.04	0.05	0.06	0.08	0.09

The specified cutting values are guide values.

The optimum data for the respective machining task should be determined during the test or machining.

Cutting data recommendations for solid carbide drills

Feed and cutting speed

Tritan-Drill-Steel | SCD661

MMG*		Workpiece material	Strength/hardness [N/mm ²] [HRC]
P	P1	P1.1 Structural, free-cutting, case hardened and heat-treated steels, non-alloy	< 700
		P1.2 Structural, free-cutting, case hardened and heat-treated steels, non-alloy	< 1,200
	P2	P2.1 Nitrided, case hardened and heat-treated steels, alloy	< 900
		P2.2 Nitrided, case hardened and heat-treated steels, alloy	< 1,400
	P3	P3.1 Tool, bearing, spring and high-speed steels**	< 800
		P3.2 Tool, bearing, spring and high-speed steels**	< 1,000
		P3.3 Tool, bearing, spring and high-speed steels**	< 1,500
P5	P5.1 Cast steel		
M	M1	M1.1 Stainless steels, austenitic	< 700
		M1.2 Stainless steels, ferritic/austenitic (duplex)	< 1,000
K	K1	K1.1 Cast iron with lamellar graphite (grey cast iron), GJL	< 300
		K2.1 Cast iron with spheroidal graphite, GJS	< 500
	K2	K2.2 Cast iron with spheroidal graphite, GJS	≤ 800
		K2.3 Cast iron with spheroidal graphite, GJS	> 800
	K3	K3.1 Cast iron with spheroidal graphite, GJV; malleable cast iron, GJM	< 500
		K3.2 Cast iron with spheroidal graphite, GJV; malleable cast iron, GJM	> 500

MEGA-Speed-Drill-Steel | SCD621

MMG*		Workpiece material	Strength/hardness [N/mm ²] [HRC]
P	P1	P1.1 Structural, free-cutting, case hardened and heat-treated steels, non-alloy	< 700
		P1.2 Structural, free-cutting, case hardened and heat-treated steels, non-alloy	< 1,200
	P2	P2.1 Nitrided, case hardened and heat-treated steels, alloy	< 900
		P2.2 Nitrided, case hardened and heat-treated steels, alloy	< 1,400
	P3	P3.1 Tool, bearing, spring and high-speed steels**	< 800
		P3.2 Tool, bearing, spring and high-speed steels**	< 1,000
		P3.3 Tool, bearing, spring and high-speed steels**	< 1,500
	P4	P4.1 Stainless steels, ferritic and martensitic	
	P5	P5.1 Cast steel	
	P6	P6.1 Stainless cast steel, ferritic and martensitic	
M	M1	M1.1 Stainless steels, austenitic	< 700
		M1.2 Stainless steels, ferritic/austenitic (duplex)	< 1,000
	M2	M2.1 Stainless/heat-resistant cast steel, austenitic	< 700
	M3	M3.1 Stainless cast steel, ferritic/austenitic (duplex)	< 1,000
K	K1	K1.1 Cast iron with lamellar graphite (grey cast iron), GJL	< 300
		K2.1 Cast iron with spheroidal graphite, GJS	< 500
	K2	K2.2 Cast iron with spheroidal graphite, GJS	≤ 800
		K2.3 Cast iron with spheroidal graphite, GJS	> 800
	K3	K3.1 Cast iron with spheroidal graphite, GJV; malleable cast iron, GJM	< 500
		K3.2 Cast iron with spheroidal graphite, GJV; malleable cast iron, GJM	> 500

* MAPAL machining groups

** If the alloy parts Cr, Mo, Ni, V, W in total > 8% then select the next highest MAPAL machining group.

	Cutting speed v_c [m/min]				Feed f [mm] for drill diameter					
	Internal cooling	External cooling	MQL	Air	4.00	5.50	7.50	10.50	14.50	20.00
	115	105	105		0.24	0.30	0.37	0.46	0.56	0.65
	105	85	85		0.30	0.37	0.46	0.58	0.70	0.81
	115	100	100		0.28	0.35	0.44	0.55	0.66	0.77
	80	70	70		0.24	0.29	0.36	0.44	0.53	0.61
	85	75	75		0.25	0.31	0.39	0.49	0.60	0.69
	70	65	65		0.21	0.26	0.33	0.41	0.49	0.56
	70	50	60		0.18	0.21	0.26	0.32	0.38	0.43
	115	100	100		0.28	0.35	0.44	0.55	0.66	0.77
	55	35	35		0.11	0.14	0.18	0.22	0.27	0.31
	140	100	100	100	0.34	0.45	0.58	0.75	0.92	1.08
	185	115	140	140	0.34	0.43	0.55	0.70	0.85	1.00
	115	85	85		0.30	0.38	0.48	0.61	0.74	0.86
	70	45	60		0.16	0.20	0.25	0.31	0.38	0.44
	105	90	90		0.32	0.41	0.52	0.65	0.79	0.92
	90	80	80		0.27	0.34	0.42	0.52	0.63	0.73

	Cutting speed v_c [m/min]				Feed f [mm] for drill diameter					
	Internal cooling	External cooling	MQL	Air	3.00	4.50	6.50	9.50	14.00	20.00
	170	155	155		0.13	0.17	0.22	0.29	0.36	0.43
	155	130	130		0.16	0.21	0.28	0.36	0.45	0.54
	170	145	145		0.15	0.20	0.26	0.34	0.43	0.51
	120	100	100		0.13	0.17	0.21	0.27	0.34	0.40
	130	110	110		0.13	0.18	0.23	0.30	0.39	0.46
	100	95	95		0.12	0.15	0.20	0.25	0.32	0.37
	100	75	85		0.10	0.12	0.16	0.20	0.25	0.29
	100	75	85		0.09	0.12	0.16	0.20	0.25	0.30
	170	145	145		0.15	0.20	0.26	0.34	0.43	0.51
	100	75	85		0.09	0.12	0.16	0.20	0.25	0.30
	65	40	40		0.07	0.09	0.12	0.15	0.19	0.23
	60	35	35		0.06	0.08	0.10	0.13	0.17	0.20
	65	40	40		0.07	0.09	0.12	0.15	0.19	0.23
	60	35	35		0.06	0.08	0.10	0.13	0.17	0.20
	150	105	105	105	0.14	0.21	0.28	0.38	0.49	0.59
	200	125	150	150	0.14	0.20	0.27	0.36	0.46	0.54
	125	95	95		0.13	0.18	0.24	0.31	0.39	0.47
	75	50	65		0.09	0.12	0.15	0.19	0.24	0.28
	115	100	100		0.14	0.19	0.25	0.33	0.42	0.50
	100	90	90		0.12	0.16	0.21	0.27	0.34	0.40

The specified cutting values are guide values.

The optimum data for the respective machining task should be determined during the test or machining.

Cutting data recommendations for solid carbide drills

Feed and cutting speed

MEGA 180° Drill | SCD231

MMG*	Workpiece material		Strength/hardness [N/mm ²] [HRC]
P	P1	P1.1 Structural, free-cutting, case hardened and heat-treated steels, non-alloy	< 700
		P1.2 Structural, free-cutting, case hardened and heat-treated steels, non-alloy	< 1,200
	P2	P2.1 Nitrided, case hardened and heat-treated steels, alloy	< 900
		P2.2 Nitrided, case hardened and heat-treated steels, alloy	< 1,400
	P3	P3.1 Tool, bearing, spring and high-speed steels**	< 800
		P3.2 Tool, bearing, spring and high-speed steels**	< 1,000
		P3.3 Tool, bearing, spring and high-speed steels**	< 1,500
	P5	P5.1 Cast steel	
K	K1	K1.1 Cast iron with lamellar graphite (grey cast iron), GJL	< 300
		K2.1 Cast iron with spheroidal graphite, GJS	< 500
	K2	K2.2 Cast iron with spheroidal graphite, GJS	≤ 800
		K2.3 Cast iron with spheroidal graphite, GJS	> 800
	K3	K3.1 Cast iron with spheroidal graphite, GJV; malleable cast iron, GJM	< 500
		K3.2 Cast iron with spheroidal graphite, GJV; malleable cast iron, GJM	> 500

ECU-Drill-Steel | SCD360, 361

MMG*	Workpiece material		Strength/hardness [N/mm ²] [HRC]
P	P1	P1.1 Structural, free-cutting, case hardened and heat-treated steels, non-alloy	< 700
		P1.2 Structural, free-cutting, case hardened and heat-treated steels, non-alloy	< 1,200
	P2	P2.1 Nitrided, case hardened and heat-treated steels, alloy	< 900
		P2.2 Nitrided, case hardened and heat-treated steels, alloy	< 1,400
	P3	P3.1 Tool, bearing, spring and high-speed steels**	< 800
		P3.2 Tool, bearing, spring and high-speed steels**	< 1,000
		P3.3 Tool, bearing, spring and high-speed steels**	< 1,500
	P4	P4.1 Stainless steels, ferritic and martensitic	
	P5	P5.1 Cast steel	
	P6	P6.1 Stainless cast steel, ferritic and martensitic	
K	K1	K1.1 Cast iron with lamellar graphite (grey cast iron), GJL	< 300
		K2.1 Cast iron with spheroidal graphite, GJS	< 500
	K2	K2.2 Cast iron with spheroidal graphite, GJS	≤ 800
		K2.3 Cast iron with spheroidal graphite, GJS	> 800
	K3	K3.1 Cast iron with spheroidal graphite, GJV; malleable cast iron, GJM	< 500
		K3.2 Cast iron with spheroidal graphite, GJV; malleable cast iron, GJM	> 500

* MAPAL machining groups

** If the alloy parts Cr, Mo, Ni, V, W in total > 8% then select the next highest MAPAL machining group.

	Cutting speed v_c [m/min]				Feed f [mm] for drill diameter					
	Internal cooling	External cooling	MQL	Air	3.00	4.50	6.50	9.50	14.00	20.00
	80	70	70		0.07	0.09	0.12	0.16	0.20	0.24
	70	60	60		0.09	0.12	0.15	0.20	0.25	0.30
	80	70	70		0.08	0.11	0.14	0.19	0.24	0.28
	55	50	50		0.07	0.09	0.12	0.15	0.19	0.22
	60	50	50		0.07	0.10	0.13	0.17	0.21	0.25
	50	45	45		0.06	0.08	0.11	0.14	0.17	0.21
	50	35	40		0.05	0.07	0.09	0.11	0.14	0.16
	80	70	70		0.08	0.11	0.14	0.19	0.24	0.28
	95	70	70	70	0.09	0.14	0.19	0.25	0.33	0.39
	130	80	95	95	0.10	0.13	0.18	0.24	0.30	0.36
	80	60	60		0.09	0.12	0.16	0.21	0.26	0.31
	50	30	40		0.06	0.08	0.11	0.14	0.17	0.21
	70	65	65		0.09	0.13	0.17	0.22	0.28	0.33
	65	55	55		0.08	0.11	0.14	0.18	0.22	0.26

	Cutting speed v_c [m/min]				Feed f [mm] for drill diameter					
	Internal cooling	External cooling	MQL	Air	1.00	1.82	3.31	6.03	10.99	20.00
	75	70	70		0.04	0.06	0.08	0.13	0.20	0.27
	70	55	55		0.05	0.07	0.11	0.16	0.24	0.33
	75	65	65		0.05	0.07	0.10	0.15	0.23	0.31
	55	45	45		0.05	0.06	0.09	0.13	0.18	0.25
	55	50	50		0.04	0.06	0.09	0.14	0.21	0.28
	45	40	40		0.04	0.05	0.08	0.12	0.17	0.23
	45	35	40		0.04	0.05	0.06	0.09	0.13	0.18
	45	35	40		0.03	0.04	0.06	0.09	0.14	0.19
	75	65	65		0.05	0.07	0.10	0.15	0.23	0.31
	45	35	40		0.03	0.04	0.06	0.09	0.14	0.19
	80	60	60	60	0.04	0.07	0.12	0.20	0.32	0.44
	110	70	80	80	0.05	0.07	0.12	0.19	0.30	0.41
	70	50	50		0.04	0.07	0.11	0.17	0.26	0.35
	40	25	35		0.04	0.05	0.08	0.12	0.17	0.23
	60	55	55		0.05	0.07	0.11	0.18	0.27	0.38
	55	50	50		0.05	0.07	0.10	0.15	0.22	0.30

The specified cutting values are guide values.

The optimum data for the respective machining task should be determined during the test or machining.

Cutting data recommendations for solid carbide drills

Feed and cutting speed

MEGA-Drill-Inox | SCD120, 121

MMG*	Workpiece material	Strength/hardness [N/mm ²] [HRC]
P	P1.1 Structural, free-cutting, case hardened and heat-treated steels, non-alloy	< 700
	P1.2 Structural, free-cutting, case hardened and heat-treated steels, non-alloy	< 1,200
	P2.1 Nitrided, case hardened and heat-treated steels, alloy	< 900
	P2.2 Nitrided, case hardened and heat-treated steels, alloy	< 1,400
	P3.1 Tool, bearing, spring and high-speed steels**	< 800
	P3.2 Tool, bearing, spring and high-speed steels**	< 1,000
	P3.3 Tool, bearing, spring and high-speed steels**	< 1,500
	P4.1 Stainless steels, ferritic and martensitic	
	P5.1 Cast steel	
	P6.1 Stainless cast steel, ferritic and martensitic	
M	M1.1 Stainless steels, austenitic	< 700
	M1.2 Stainless steels, ferritic/austenitic (duplex)	< 1,000
	M2.1 Stainless/heat-resistant cast steel, austenitic	< 700
	M3.1 Stainless cast steel, ferritic/austenitic (duplex)	< 1,000
K	K1.1 Cast iron with lamellar graphite (grey cast iron), GJL	< 300
	K2.1 Cast iron with spheroidal graphite, GJS	< 500
	K2.2 Cast iron with spheroidal graphite, GJS	≤ 800
	K2.3 Cast iron with spheroidal graphite, GJS	> 800
	K3.1 Cast iron with spheroidal graphite, GJV; malleable cast iron, GJM	< 500
	K3.2 Cast iron with spheroidal graphite, GJV; malleable cast iron, GJM	> 500
N	N2.1 Copper, non-alloy and low-alloy	< 300
	N2.2 Copper, alloy	> 300
	N2.3 Brass, bronze, gunmetal	< 1,200

MEGA-Speed-Drill-Inox | SCD411

MMG*	Workpiece material	Strength/hardness [N/mm ²] [HRC]
P	P1.1 Structural, free-cutting, case hardened and heat-treated steels, non-alloy	< 700
	P1.2 Structural, free-cutting, case hardened and heat-treated steels, non-alloy	< 1,200
	P2.1 Nitrided, case hardened and heat-treated steels, alloy	< 900
	P2.2 Nitrided, case hardened and heat-treated steels, alloy	< 1,400
	P3.1 Tool, bearing, spring and high-speed steels**	< 800
	P3.2 Tool, bearing, spring and high-speed steels**	< 1,000
	P3.3 Tool, bearing, spring and high-speed steels**	< 1,500
	P4.1 Stainless steels, ferritic and martensitic	
	P5.1 Cast steel	
	P6.1 Stainless cast steel, ferritic and martensitic	
M	M1.1 Stainless steels, austenitic	< 700
	M1.2 Stainless steels, ferritic/austenitic (duplex)	< 1,000
	M2.1 Stainless/heat-resistant cast steel, austenitic	< 700
	M3.1 Stainless cast steel, ferritic/austenitic (duplex)	< 1,000
S	S1.1 Titanium, titanium alloys	< 400
	S2.1 Titanium, titanium alloys	< 1,200
	S2.2 Titanium, titanium alloys	> 1,200
	S3.1 Nickel, unalloyed and alloyed	< 900
	S3.2 Nickel, unalloyed and alloyed	> 900
	S4.1 High-temperature super alloy Ni, Co and Fe-based	
	S5.1 Tungsten and molybdenum alloys	

* MAPAL machining groups

** If the alloy parts Cr, Mo, Ni, V, W in total > 8% then select the next highest MAPAL machining group.

	Cutting speed v_c [m/min]				Feed f [mm] for drill diameter					
	Internal cooling	External cooling	MQL	Air	3.00	4.50	6.50	9.50	14.00	20.00
	100	90	90		0.07	0.09	0.12	0.16	0.20	0.24
	90	75	75		0.09	0.12	0.15	0.20	0.25	0.30
	100	85	85		0.08	0.11	0.14	0.19	0.24	0.28
	70	60	60		0.07	0.09	0.12	0.15	0.19	0.22
	75	65	65		0.07	0.10	0.13	0.17	0.21	0.25
	60	55	55		0.06	0.08	0.11	0.14	0.17	0.21
	60	45	50		0.05	0.07	0.09	0.11	0.14	0.16
	60	45	50		0.05	0.07	0.09	0.11	0.14	0.17
	100	85	85		0.08	0.11	0.14	0.19	0.24	0.28
	60	45	50		0.05	0.07	0.09	0.11	0.14	0.17
	55	35	35		0.06	0.08	0.11	0.14	0.18	0.21
	50	30	30		0.05	0.07	0.09	0.12	0.15	0.18
	55	35	35		0.06	0.08	0.11	0.14	0.18	0.21
	50	30	30		0.05	0.07	0.09	0.12	0.15	0.18
	120	85	85	85	0.12	0.17	0.24	0.32	0.41	0.49
	160	100	120	120	0.12	0.17	0.22	0.30	0.38	0.45
	100	75	75		0.11	0.15	0.20	0.26	0.33	0.39
	60	40	50		0.08	0.10	0.13	0.17	0.22	0.26
	90	80	80		0.12	0.16	0.21	0.28	0.35	0.42
	80	70	70		0.10	0.13	0.17	0.22	0.28	0.33
	140	100			0.09	0.12	0.15	0.20	0.25	0.30
	120	90			0.11	0.15	0.20	0.26	0.33	0.39
	200	160	160	120	0.12	0.17	0.24	0.32	0.41	0.49

	Cutting speed v_c [m/min]				Feed f [mm] for drill diameter					
	Internal cooling	External cooling	MQL	Air	3.00	4.50	6.50	9.50	14.00	20.00
	150	135	135		0.09	0.12	0.15	0.20	0.25	0.30
	135	115	115		0.11	0.15	0.19	0.25	0.31	0.37
	150	130	130		0.10	0.14	0.18	0.23	0.30	0.35
	105	90	90		0.09	0.12	0.15	0.19	0.24	0.28
	115	100	100		0.09	0.12	0.16	0.21	0.27	0.32
	90	85	85		0.08	0.10	0.13	0.17	0.22	0.26
	90	70	75		0.07	0.09	0.11	0.14	0.17	0.20
	70	55	60		0.06	0.08	0.11	0.14	0.18	0.21
	150	130	130		0.10	0.14	0.18	0.23	0.30	0.35
	70	55	60		0.06	0.08	0.11	0.14	0.18	0.21
	80	50	50		0.08	0.10	0.13	0.17	0.22	0.26
	75	45	45		0.07	0.09	0.11	0.15	0.19	0.22
	80	50	50		0.08	0.10	0.13	0.17	0.22	0.26
	75	45	45		0.07	0.09	0.11	0.15	0.19	0.22
					0.07	0.10	0.13	0.17	0.21	0.25
	35	25			0.06	0.08	0.11	0.14	0.18	0.21
	30	20			0.05	0.07	0.09	0.12	0.15	0.18
	25	20			0.04	0.06	0.07	0.10	0.12	0.14
	20	10			0.05	0.07	0.09	0.12	0.15	0.18
	20	10			0.04	0.06	0.07	0.10	0.12	0.14
	20	10			0.04	0.06	0.07	0.10	0.12	0.14

The specified cutting values are guide values.

The optimum data for the respective machining task should be determined during the test or machining.

Cutting data recommendations for solid carbide drills

Feed and cutting speed

MEGA-Speed-Drill-Iron | SCD421

MMG*	Workpiece material		Strength/hardness [N/mm ²] [HRC]
K	K1	K1.1 Cast iron with lamellar graphite (grey cast iron), GJL	< 300
		K2.1 Cast iron with spheroidal graphite, GJS	< 500
	K2	K2.2 Cast iron with spheroidal graphite, GJS	≤ 800
		K2.3 Cast iron with spheroidal graphite, GJS	> 800
	K3	K3.1 Cast iron with spheroidal graphite, GJV; malleable cast iron, GJM	< 500
		K3.2 Cast iron with spheroidal graphite, GJV; malleable cast iron, GJM	> 500

MEGA-Drill-Alu | SCD131

MMG*	Workpiece material		Strength/hardness [N/mm ²] [HRC]
N	N1	N1.1 Aluminium, non-alloy and alloy < 3 % Si	
		N1.2 Aluminium, alloy ≤ 7 % Si	
		N1.3 Aluminium, alloy > 7-12 % Si	
		N1.4 Aluminium, alloy > 12 % Si	
	N2	N2.1 Copper, non-alloy and low-alloy	< 300
		N2.2 Copper, alloy	> 300
N2.3 Brass, bronze, gunmetal		< 1,200	

MEGA-Drill-Composite-MD | SCD250

MMG*	Workpiece material		Strength/hardness [N/mm ²] [HRC]
N	N3	N3.1 Graphite, > 8 μm	
		N3.2 Graphite, ≤ 8 μm	
C	C1	C1.1 Plastic matrix, aramide fibre-reinforced (AFRP)	
		C1.2 Plastic matrix (thermosetting), CFRP/GFRP	
		C1.3 Plastic matrix (thermoplastic), CFRP/GFRP	
	C2	C2.1 Carbon matrix, carbon fibre-reinforced (CFC)	
		C3.1 Metal matrix (MMC)	
	C4	C4.1 Sandwich construction, honeycomb core (Honeycomb)	
		C4.2 Sandwich construction, foam core	

MEGA-Drill-Composite-UDX | SCD270, 271

MMG*	Workpiece material		Strength/hardness [N/mm ²] [HRC]
C	C1	C1.1 Plastic matrix, aramide fibre-reinforced (AFRP)	
		C1.2 Plastic matrix (thermosetting), CFRP/GFRP	
		C1.3 Plastic matrix (thermoplastic), CFRP/GFRP	
	C2	C2.1 Carbon matrix, carbon fibre-reinforced (CFC)	

* MAPAL machining groups

	Cutting speed v_c [m/min]				Feed f [mm] for drill diameter					
	Internal cooling	External cooling	MQL	Air	3.00	4.50	6.50	9.50	14.00	20.00
	170	120	120	120	0.15	0.21	0.29	0.40	0.51	0.61
	225	140	170	170	0.15	0.21	0.28	0.37	0.48	0.57
	140	105	105		0.14	0.19	0.25	0.32	0.41	0.49
	85	55	70		0.10	0.13	0.17	0.22	0.27	0.32
	125	110	110		0.15	0.20	0.26	0.35	0.44	0.52
	110	100	100		0.13	0.17	0.22	0.28	0.35	0.41

	Cutting speed v_c [m/min]				Feed f [mm] for drill diameter					
	Internal cooling	External cooling	MQL	Air	3.00	4.50	6.50	9.50	14.00	20.00
	300	200	250		0.09	0.12	0.15	0.20	0.25	0.30
	250	180	200		0.11	0.15	0.20	0.26	0.33	0.39
	220	150	180		0.11	0.15	0.20	0.26	0.33	0.39
	180	120	150		0.11	0.15	0.20	0.26	0.33	0.39
	140	100			0.09	0.12	0.15	0.20	0.25	0.30
	120	90			0.11	0.15	0.20	0.26	0.33	0.39
	200	160	160	120	0.09	0.14	0.19	0.25	0.33	0.39

	Cutting speed v_c [m/min]				Feed f [mm] for drill diameter					
	Internal cooling	External cooling	MQL	Air	3.00	4.00	5.50	7.50	10.00	12.00
				200	0.07	0.09	0.11	0.14	0.16	0.18
				200	0.07	0.09	0.11	0.14	0.16	0.18
				90	0.04	0.04	0.05	0.06	0.07	0.08
				75	0.04	0.04	0.05	0.06	0.07	0.08
				75	0.04	0.04	0.05	0.06	0.07	0.08
				400	0.04	0.04	0.05	0.06	0.07	0.08
				400	0.04	0.04	0.05	0.06	0.07	0.08

	Cutting speed v_c [m/min]				Feed f [mm] for drill diameter					
	Internal cooling	External cooling	MQL	Air	3.00	4.00	5.50	7.50	10.00	12.00
				90	0.04	0.04	0.05	0.06	0.07	0.08
				75	0.04	0.04	0.05	0.06	0.07	0.08
				75	0.04	0.04	0.05	0.06	0.07	0.08

The specified cutting values are guide values.

The optimum data for the respective machining task should be determined during the test or machining.

Cutting data recommendations for solid carbide drills

Feed and cutting speed

MEGA-180°-Drill-Alu | SCD241

MMG*	Workpiece material		Strength/hardness [N/mm ²] [HRC]
N	N1	N1.1 Aluminium, unalloyed and alloyed < 3 % Si	
		N1.2 Aluminium, alloyed ≤ 7 % Si	
		N1.3 Aluminium, alloyed > 7 - 12 % Si	
		N1.4 Aluminium, alloyed > 12 % Si	
N2		N2.1 Copper, non-alloy and low-alloy	< 300
		N2.2 Copper, alloy	> 300
		N2.3 Brass, bronze, gunmetal	< 1,200

Ecu-G-Drill | SCD211

MMG*	Workpiece material		Strength/hardness [N/mm ²] [HRC]	
K	K1	K1.1 Cast iron with lamellar graphite (grey cast iron), GJL	< 300	
		K2.1 Cast iron with spheroidal graphite, GJS	< 500	
		K2.2 Cast iron with spheroidal graphite, GJS	≤ 800	
		K2.3 Cast iron with spheroidal graphite, GJS	> 800	
N	N1	N1.1 Aluminium, non-alloy and alloy < 3 % Si		
		N1.2 Aluminium, alloy ≤ 7 % Si		
		N1.3 Aluminium, alloy > 7-12 % Si		
		N1.4 Aluminium, alloy > 12 % Si		
	N2		N2.1 Copper, non-alloy and low-alloy	< 300
			N2.2 Copper, alloy	> 300
			N2.3 Brass, bronze, gunmetal	< 1,200

	Cutting speed v_c [m/min]				Feed f [mm] for drill diameter					
	Internal cooling	External cooling	MQL	Air	3.00	4.50	6.50	9.50	14.00	20.00
	240	160	200		0.07	0.09	0.12	0.16	0.20	0.24
	200	145	160		0.09	0.12	0.16	0.21	0.26	0.31
	175	120	145		0.09	0.12	0.16	0.21	0.26	0.31
	145	95	120		0.09	0.12	0.16	0.21	0.26	0.31
	110	80			0.07	0.09	0.12	0.16	0.20	0.24
	95	70			0.09	0.12	0.16	0.21	0.26	0.31
	160	130	130	95	0.09	0.14	0.19	0.25	0.33	0.39

	Cutting speed v_c [m/min]				Feed f [mm] for drill diameter					
	Internal cooling	External cooling	MQL	Air	3.00	4.50	6.50	9.50	14.00	20.00
	90	65	65	65	0.08	0.12	0.16	0.22	0.29	0.34
	120	75	90	90	0.08	0.12	0.16	0.21	0.27	0.32
	75	55	55		0.08	0.10	0.14	0.18	0.23	0.27
	215	155	170		0.08	0.10	0.14	0.18	0.23	0.27
	185	130	155		0.08	0.10	0.14	0.18	0.23	0.27
	155	100	130		0.08	0.10	0.14	0.18	0.23	0.27
	160	130	130	95	0.08	0.12	0.16	0.22	0.29	0.34

The specified cutting values are guide values.

The optimum data for the respective machining task should be determined during the test or machining.



DRILLING FROM THE SOLID WITH A REPLACEABLE HEAD SYSTEM



QTD indexable insert drill

Technology	184
Type 01 - Steel	186
Type 05 - Steel-Pyramid	188
Type 10 - Uni, EK-Shaped	190
Type 02 - Inox	191
Type 04 - Iron	193
Type 03 - Alu	194
QTS indexable insert holder	195
Accessories and spare parts	198
Cutting data recommendations	200

TTD replaceable head drill

Technology	204
Type 01 - Uni-Plus	206
Type 04 - Steel	207
Type 02 - Inox	209
Type 05 - Iron	211
Type 03 - Alu	212
TTS replaceable head holders	213
Accessories and spare parts	222
Cutting data recommendations	224

TTD-Tritan replaceable head drill

Technology	228
Type 01 - Uni	230
TTS 300 replaceable head holders	231
Accessories and spare parts	234
Cutting data recommendations	236



QTD INDEXABLE INSERT DRILL

Stable insert mounting, simple clamping system

With the latest manufacturing technology with a diameter range from 8 to 50 mm

The QTD indexable insert drill for the medium to upper diameter range impresses with very good chip formation and reliable chip removal. Numerous indexable insert changes are possible per holder, as the basic holder is not eroded. The clamping system for the indexable insert is both particularly simple and extremely effective. It consists of a screw that is inserted transversely through the indexable insert, clamping the indexable insert stably in the prism mounting. The indexable insert is held particularly stable in the prism mounting such that high cutting data and bore qualities are possible.

Additive manufacturing enables optimum coolant outlet design and diameters from 9 mm

Additive manufacturing is used to produce diameters smaller than 13 mm. This method makes it possible to manufacture tool bodies in the diameter range 8 to 13 mm with spiral cooling channels. Compared to central coolant supply with diversions, the QTD with coiled channels achieves a 100% increase in the coolant flow rate, particularly due to the deviation from the circular cooling channel profile.

Tool features in detail



1 Shank in accordance with ISO 9766

2 Plane shank face connection

3 Line for maximum drilling depth

4 Rear clearance
– For optimal chip removal

5 Optimal force transmission
– Due to embedded indexable insert

6 Hardened steel mount with cylindrical shank

7 Stable clamping TORX PLUS®

8 Prismatic insert seat
– For optimal centring of the indexable insert

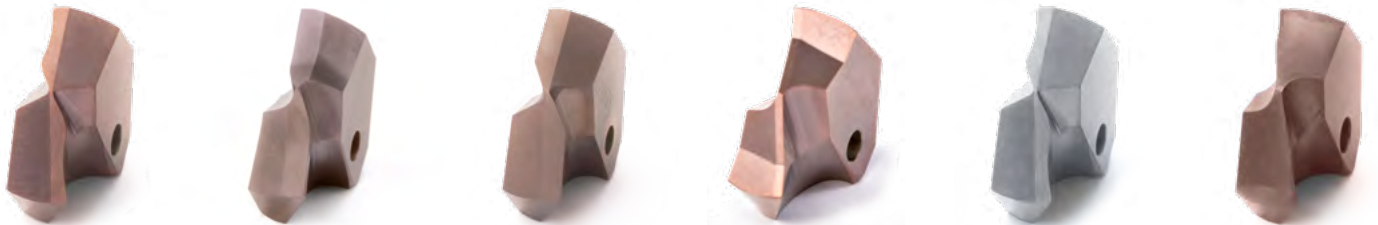

AT A GLANCE

- High availability of stock
- Diameter range from 9 to 50 mm
- Holder range 1.5 | 3 | 5 | 8 and 12xD
- Indexable inserts for steel, stainless steel, aluminium and cast iron
- With internal cooling
- Special surface treatment
- Easy to handle, indexable insert change in the machine

PERFORMANCE FEATURES

- Same performance as a solid carbide drill
- High degree of radial run-out accuracy
- Stable collar to absorb high axial forces
- Secure clamping of the indexable insert with TORX PLUS® screw
- Robust system

ADVANTAGES

- Optimised costs
- Highest performance
- Non-confusable indexable insert installation
- Optimum chip formation in the indexable insert and chip removal
- One tool holder for all drill geometries
- Large number of indexable insert changes per tool holder possible, as there is no wash-out of the basic holder

QTD indexable inserts

Produced from solid carbide, internal coolant supply
Type 01 - Steel

Design:

Drill diameter: 9.00 - 50.00 mm
Bore tolerance: \geq IT 10
Cutting material: HP240
Number of cutting edges: 2
Number of guiding chamfers: 2
Tip angle: 135°

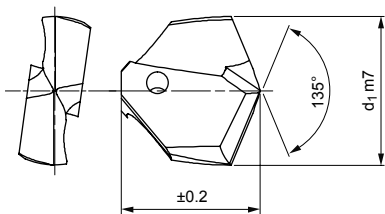

Stocked preferred series

d ₁ from 9.00 to 15.50			
d ₁ m7	Tool holder size D	Specification	Order no.
9,00	9	QTD-2F01-0900-HP240	30615635
9,50	9,5	QTD-2F01-0950-HP240	30615636
10,00	10	QTD-2F01-1000-HP240	30615638
10,20	10	QTD-2F01-1020-HP240	30646024
10,50	10,5	QTD-2F01-1050-HP240	30615639
10,70	10,5	QTD-2F01-1070-HP240	30615640
11,00	11	QTD-2F01-1100-HP240	30615641
11,50	11,5	QTD-2F01-1150-HP240	30615642
12,00	12	QTD-2F01-1200-HP240	30615644
12,50	12,5	QTD-2F01-1250-HP240	30615645
12,70	12,5	QTD-2F01-1270-HP240	30615646
12,80	12,5	QTD-2F01-1280-HP240	30646043
13,00	13	QTD-2F01-1300-HP240	30572990
13,10	13	QTD-2F01-1310-HP240	30646045
13,30	13	QTD-2F01-1330-HP240	30646047
13,40	13	QTD-2F01-1340-HP240	30646048
13,50	13,5	QTD-2F01-1350-HP240	30572991
13,80	13,5	QTD-2F01-1380-HP240	30646050
13,90	13,5	QTD-2F01-1390-HP240	30646051
14,00	14	QTD-2F01-1400-HP240	30572993
14,10	14	QTD-2F01-1410-HP240	30646052
14,20	14	QTD-2F01-1420-HP240	30646053
14,30	14	QTD-2F01-1430-HP240	30646055
14,50	14,5	QTD-2F01-1450-HP240	30572994
14,60	14,5	QTD-2F01-1460-HP240	30646057
14,70	14,5	QTD-2F01-1470-HP240	30572995
14,80	14,5	QTD-2F01-1480-HP240	30646058
14,90	14,5	QTD-2F01-1490-HP240	30646059
15,00	15	QTD-2F01-1500-HP240	30572997
15,10	15	QTD-2F01-1510-HP240	30646060
15,20	15	QTD-2F01-1520-HP240	30646061
15,25	15	QTD-2F01-1525-HP240	30572998
15,50	15	QTD-2F01-1550-HP240	30572999

d ₁ from 15.70 to 19.50			
d ₁ m7	Tool holder size D	Specification	Order no.
15,70	15	QTD-2F01-1570-HP240	30573000
15,80	15	QTD-2F01-1580-HP240	30646066
15,90	15	QTD-2F01-1590-HP240	30646068
16,00	16	QTD-2F01-1600-HP240	30573001
16,10	16	QTD-2F01-1610-HP240	30573003
16,20	16	QTD-2F01-1620-HP240	30646069
16,25	16	QTD-2F01-1625-HP240	30573004
16,30	16	QTD-2F01-1630-HP240	30610882
16,40	16	QTD-2F01-1640-HP240	30646071
16,50	16	QTD-2F01-1650-HP240	30573005
16,60	16	QTD-2F01-1660-HP240	30646072
16,70	16	QTD-2F01-1670-HP240	30573006
16,80	16	QTD-2F01-1680-HP240	30646074
16,90	16	QTD-2F01-1690-HP240	30646075
17,00	17	QTD-2F01-1700-HP240	30573009
17,10	17	QTD-2F01-1710-HP240	30646076
17,20	17	QTD-2F01-1720-HP240	30646077
17,30	17	QTD-2F01-1730-HP240	30646078
17,40	17	QTD-2F01-1740-HP240	30646079
17,50	17	QTD-2F01-1750-HP240	30573010
17,60	17	QTD-2F01-1760-HP240	30646081
17,70	17	QTD-2F01-1770-HP240	30573011
17,80	17	QTD-2F01-1780-HP240	30646082
17,90	17	QTD-2F01-1790-HP240	30646083
18,00	18	QTD-2F01-1800-HP240	30573012
18,10	18	QTD-2F01-1810-HP240	30646084
18,50	18	QTD-2F01-1850-HP240	30573014
18,60	18	QTD-2F01-1860-HP240	30646088
18,70	18	QTD-2F01-1870-HP240	30573015
18,80	18	QTD-2F01-1880-HP240	30646089
18,90	18	QTD-2F01-1890-HP240	30646090
19,00	19	QTD-2F01-1900-HP240	30573016
19,50	19	QTD-2F01-1905-HP240	30646091

Indexable inserts QTD produced from solid carbide, internal coolant supply – Type O1

d ₁ from 19.10 to 24.70				d ₁ from 24.75 to 42.60			
d ₁ m7	Tool holder size D	Specification	Order no.	d ₁ m7	Tool holder size D	Specification	Order no.
19,10	19	QTD-2F01-1910-HP240	30646092	24,75	24	QTD-2F01-2475-HP240	30573046
19,20	19	QTD-2F01-1920-HP240	30573017	24,80	24	QTD-2F01-2480-HP240	30660662
19,25	19	QTD-2F01-1925-HP240	30573018	25,00	25	QTD-2F01-2500-HP240	30573047
19,30	19	QTD-2F01-1930-HP240	30646094	25,40	25	QTD-2F01-2540-HP240	30573048
19,50	19	QTD-2F01-1950-HP240	30573020	25,50	25	QTD-2F01-2550-HP240	30573049
19,60	19	QTD-2F01-1960-HP240	30646095	25,70	25	QTD-2F01-2570-HP240	30573050
19,70	19	QTD-2F01-1970-HP240	30573021	25,80	25	QTD-2F01-2580-HP240	30584730
19,75	19	QTD-2F01-1975-HP240	30573022	26,00	26	QTD-2F01-2600-HP240	30573051
19,80	19	QTD-2F01-1980-HP240	30646096	26,50	26	QTD-2F01-2650-HP240	30573052
19,90	19	QTD-2F01-1990-HP240	30646097	27,00	27	QTD-2F01-2700-HP240	30573053
20,00	20	QTD-2F01-2000-HP240	30573023	27,50	27	QTD-2F01-2750-HP240	30573054
20,40	20	QTD-2F01-2040-HP240	30573024	27,75	27	QTD-2F01-2775-HP240	30573055
20,50	20	QTD-2F01-2050-HP240	30573025	28,00	28	QTD-2F01-2800-HP240	30573056
20,70	20	QTD-2F01-2070-HP240	30573026	28,50	28	QTD-2F01-2850-HP240	30573058
20,75	20	QTD-2F01-2075-HP240	30573027	29,00	29	QTD-2F01-2900-HP240	30573059
21,00	21	QTD-2F01-2100-HP240	30573028	29,50	29	QTD-2F01-2950-HP240	30573060
21,50	21	QTD-2F01-2150-HP240	30573029	29,80	29	QTD-2F01-2980-HP240	30728319
21,70	21	QTD-2F01-2170-HP240	30573030	30,00	30	QTD-2F01-3000-HP240	30573062
22,00	22	QTD-2F01-2200-HP240	30573031	30,25	30	QTD-2F01-3025-HP240	30573063
22,25	22	QTD-2F01-2225-HP240	30573032	30,50	30	QTD-2F01-3050-HP240	30573064
22,50	22	QTD-2F01-2250-HP240	30573034	31,00	31	QTD-2F01-3100-HP240	30573066
22,70	22	QTD-2F01-2270-HP240	30573035	31,50	31	QTD-2F01-3150-HP240	30573067
22,75	22	QTD-2F01-2275-HP240	30573036	32,00	32	QTD-2F01-3200-HP240	30573068
23,00	23	QTD-2F01-2300-HP240	30573037	33,00	33	QTD-2F01-3300-HP240	30649656
23,25	23	QTD-2F01-2325-HP240	30573038	34,00	34	QTD-2F01-3400-HP240	30649657
23,50	23	QTD-2F01-2350-HP240	30573039	35,00	35	QTD-2F01-3500-HP240	30649658
23,75	23	QTD-2F01-2375-HP240	30573042	36,00	36	QTD-2F01-3600-HP240	30649659
24,00	24	QTD-2F01-2400-HP240	30573043	37,00	37	QTD-2F01-3700-HP240	30649660
24,30	24	QTD-2F01-2430-HP240	30646105	38,00	37	QTD-2F01-3800-HP240	30649661
24,50	24	QTD-2F01-2450-HP240	30573044	40,00	39	QTD-2F01-4000-HP240	30657233
24,70	24	QTD-2F01-2470-HP240	30573045	42,00	41	QTD-2F01-4200-HP240	30657235

Configurable features

**Diameter:**

Diameter in increments of 0.01 mm freely selectable

**Specification:**

QTD-2F01-[diameter]-HP240

Example:

QTD-2F01-0901-HP240

Tool diameter d₁ = 9.01 mm

Dimensions of configurable series

d ₁ min.	d ₁ max.
9,00	50,00

Dimensions in mm.

For cutting data recommendations, see end of chapter.

Special designs and other coatings available upon request.

QTD indexable inserts

Produced from solid carbide, internal coolant supply
Type 05 - Steel-Pyramid

Design:

Drill diameter: 14.00 - 32.00 mm
Bore tolerance: \geq IT 10
Cutting material: HP605
Number of cutting edges: 2
Number of guiding chamfers: 2
Tip angle: 165°

Application:

For machining operations with special demands on tool centring (e.g. thin-walled parts, unstable machining conditions).

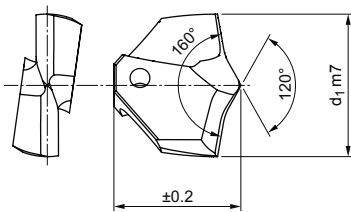

Stocked preferred series

Dimensions		Specification	Order no.
d ₁ m7	Tool holder size D		
14,00	14	QTD-2F05-1400-HP605	31126352
15,00	15	QTD-2F05-1500-HP605	31126356
16,00	16	QTD-2F05-1600-HP605	31126361
16,50	16	QTD-2F05-1650-HP605	31126364
17,50	17	QTD-2F05-1750-HP605	31126366
18,00	18	QTD-2F05-1800-HP605	31126368
18,50	18	QTD-2F05-1850-HP605	31126369
19,27	19	QTD-2F05-1927-HP605	31208007
19,80	19	QTD-2F05-1980-HP605	31126372
20,00	20	QTD-2F05-2000-HP605	31126373
20,50	20	QTD-2F05-2050-HP605	31126374
21,00	21	QTD-2F05-2100-HP605	31126375
21,50	21	QTD-2F05-2150-HP605	31126376
22,00	22	QTD-2F05-2200-HP605	31126377
23,00	23	QTD-2F05-2300-HP605	31126379
24,00	24	QTD-2F05-2400-HP605	31126380
25,00	25	QTD-2F05-2500-HP605	31126382
26,00	26	QTD-2F05-2600-HP605	31126384
26,50	26	QTD-2F05-2650-HP605	31126385
27,00	27	QTD-2F05-2700-HP605	31126386
28,00	28	QTD-2F05-2800-HP605	31126387
29,00	29	QTD-2F05-2900-HP605	31126388
30,00	30	QTD-2F05-3000-HP605	31126389
32,00	32	QTD-2F05-3200-HP605	31126391

Configurable features

Diameter:
Diameter in increments of 0.01 mm freely selectable

Specification:
QTD-2F01-[diameter]-HP240

Dimensions in mm.
For cutting data recommendations, see end of chapter.
Special designs and other coatings available upon request.

Dimensions of configurable series

d ₁ min.	d ₁ max.
14,00	32,00

Example:
QTD-2F01-1401-HP240

Tool diameter d₁ = 14.01 mm

Practical test

Machining von sheets, heat exchangers / boiler plates, steel beams (T, U, ...).

Especially for machining with special demands on tool centring as well as for thin-walled parts and unstable machining conditions.



Machining data

Tool: \varnothing 18 mm | 5xD
 Chuck: Mill chucks
 Cooling: MQL-internal cooling

IB [mm]: 90
 v_c [m/min]: 63
 n [min^{-1}]: 1,115
 f [mm]: 0.3
 v_f [mm/min]: 334

Number of bores

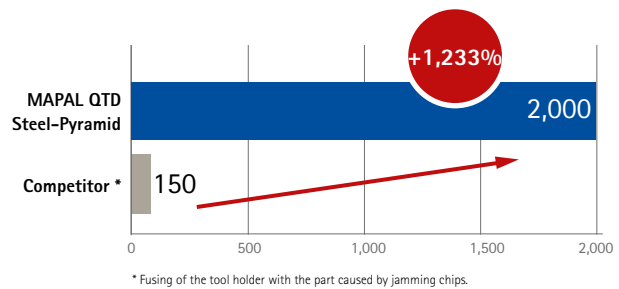

QTD indexable inserts

Produced of solid carbide,
Type 10 - Uni, EK-Shaped

Design:

Drill diameter: 10.00 - 33.00 mm
Bore tolerance: \geq IT 10
Cutting material: HP240
Number of cutting edges: 2
Number of guiding chamfers: 2
Tip angle: 142°
Special features: EK-shaped
 180° cutting edge,
protective chamfer
0.5 mm

Application:

For screw through bores according to DIN-ISO 273 and countersinks according to DIN 74, sheet 2 form H, J and K, medium design. For screws in accordance with DIN 912, 6912 and 7984, ISO 1207 (DIN 84).

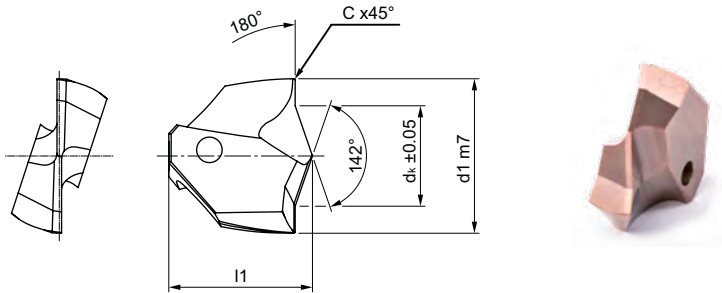

Stocked preferred series

Dimensions			For cylinder head DIN screws	Suitable for through bores in \varnothing	Specification	Order no.
d_1 m7	$d_k \pm 0,05$	Tool holder size D				
10,00	6,50	10	M5	5,5	QTD-2F10-1000-HP240	30868435
11,00	7,60	11	M6	6,6	QTD-2F10-1100-HP240	30868436
15,00	10,00	15	M8	9	QTD-2F10-1500-HP240	30868437
18,00	11,00	18	M10	11	QTD-2F10-1800-HP240	30868438
20,00	14,50	20	M12	13,5	QTD-2F10-2000-HP240	30868439
24,00	16,50	24	M14	15	QTD-2F10-2400-HP240	30868440
26,00	18,50	26	M16	17	QTD-2F10-2600-HP240	30868441
30,00	20,50	30	M18	19	QTD-2F10-3000-HP240	30868442
33,00	23,00	33	M20	21	QTD-2F10-3300-HP240	30868443

Application note:

For screw through bores with countersink for cylinder head screws DIN (example M12)

1st step:

Countersinking with QTD type 10,
form EK (example diameter 20 mm)

2nd step:

drilling with a solid drill
(example diameter 13.5 mm)

Result:

Screw through hole with countersink and chamfer
for M12 cylinder head screw

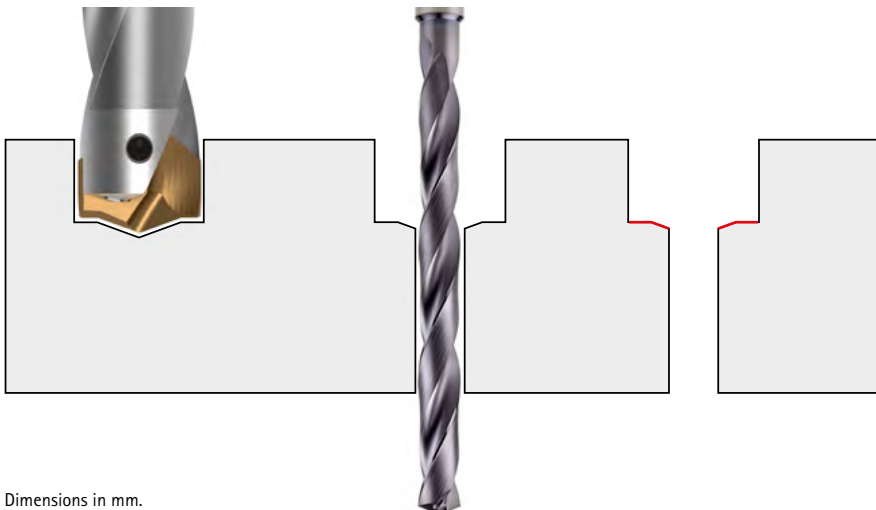

Dimensions in mm.

For cutting data recommendations, see end of chapter.

Special designs and other coatings available upon request.

QTD indexable inserts

Produced from solid carbide, internal coolant supply
Type 02 - Inox

Design:
 Drill diameter: 9.00 - 50.00 mm
 Bore tolerance: $\geq IT 10$
 Cutting material: HP600
 Number of cutting edges: 2
 Number of guiding chamfers: 2
 Tip angle: 135°

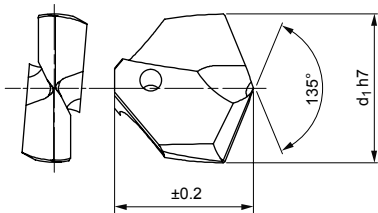

Stocked preferred series

d ₁ from 10.00 to 16.70			
d ₁ h7	Tool holder size D	Specification	Order no.
10,00	10	QTD-2F02-1000-HP600	30615624
10,50	10,5	QTD-2F02-1050-HP600	30615625
11,00	11	QTD-2F02-1100-HP600	30615627
12,00	12	QTD-2F02-1200-HP600	30615630
12,50	12,5	QTD-2F02-1250-HP600	30615631
13,00	13	QTD-2F02-1300-HP600	30573070
13,50	13,5	QTD-2F02-1350-HP600	30573072
14,00	14	QTD-2F02-1400-HP600	30573074
14,10	14	QTD-2F02-1410-HP600	30646120
14,20	14	QTD-2F02-1420-HP600	30630410
14,30	14	QTD-2F02-1430-HP600	30646122
14,40	14	QTD-2F02-1440-HP600	30646123
14,50	14,5	QTD-2F02-1450-HP600	30573075
14,60	14,5	QTD-2F02-1460-HP600	30646124
14,70	14,5	QTD-2F02-1470-HP600	30573076
14,75	14,5	QTD-2F02-1475-HP600	30573077
14,80	14,5	QTD-2F02-1480-HP600	30646125
15,00	15	QTD-2F02-1500-HP600	30573078
15,20	15	QTD-2F02-1520-HP600	30646128
15,25	15	QTD-2F02-1525-HP600	30573079
15,40	15	QTD-2F02-1540-HP600	30646130
15,50	15	QTD-2F02-1550-HP600	30573080
15,60	15	QTD-2F02-1560-HP600	30646131
15,70	15	QTD-2F02-1570-HP600	30573081
15,80	15	QTD-2F02-1580-HP600	30646132
16,00	16	QTD-2F02-1600-HP600	30573083
16,10	16	QTD-2F02-1610-HP600	30573086
16,20	16	QTD-2F02-1620-HP600	30646134
16,30	16	QTD-2F02-1630-HP600	30646135
16,40	16	QTD-2F02-1640-HP600	30646136
16,50	16	QTD-2F02-1650-HP600	30573088
16,60	16	QTD-2F02-1660-HP600	30646137
16,70	16	QTD-2F02-1670-HP600	30573089

d ₁ from 16.75 to 23.75			
d ₁ h7	Tool holder size D	Specification	Order no.
16,75	16	QTD-2F02-1675-HP600	30573090
16,80	16	QTD-2F02-1680-HP600	30646138
16,90	16	QTD-2F02-1690-HP600	30646139
17,00	17	QTD-2F02-1700-HP600	30573091
17,30	17	QTD-2F02-1730-HP600	30646142
17,40	17	QTD-2F02-1740-HP600	30646143
17,50	17	QTD-2F02-1750-HP600	30573092
17,70	17	QTD-2F02-1770-HP600	30573093
17,90	17	QTD-2F02-1790-HP600	30646146
18,00	18	QTD-2F02-1800-HP600	30573094
18,50	18	QTD-2F02-1850-HP600	30573096
18,60	18	QTD-2F02-1860-HP600	30646151
18,70	18	QTD-2F02-1870-HP600	30573097
19,00	19	QTD-2F02-1900-HP600	30573098
19,40	19	QTD-2F02-1940-HP600	30573101
19,50	19	QTD-2F02-1950-HP600	30573102
19,60	19	QTD-2F02-1960-HP600	30646157
19,70	19	QTD-2F02-1970-HP600	30573103
19,75	19	QTD-2F02-1975-HP600	30573104
19,80	19	QTD-2F02-1980-HP600	30646158
19,90	19	QTD-2F02-1990-HP600	30646159
20,00	20	QTD-2F02-2000-HP600	30573105
20,40	20	QTD-2F02-2040-HP600	30573106
20,50	20	QTD-2F02-2050-HP600	30573107
21,00	21	QTD-2F02-2100-HP600	30573110
21,50	21	QTD-2F02-2150-HP600	30573111
21,70	21	QTD-2F02-2170-HP600	30573112
22,00	22	QTD-2F02-2200-HP600	30573113
22,25	22	QTD-2F02-2225-HP600	30573114
22,70	22	QTD-2F02-2270-HP600	30573117
23,00	23	QTD-2F02-2300-HP600	30573119
23,50	23	QTD-2F02-2350-HP600	30573121
23,75	23	QTD-2F02-2375-HP600	30573124

Continued on next page.

Indexable inserts QTD produced from solid carbide, internal coolant supply – Type O2

d ₁ from 24.00 to 27.00			
d ₁ h7	Tool holder size D	Specification	Order no.
24,00	24	QTD-2F02-2400-HP600	30573125
24,40	24	QTD-2F02-2440-HP600	30665151
24,50	24	QTD-2F02-2450-HP600	30573126
24,70	24	QTD-2F02-2470-HP600	30573127
24,75	24	QTD-2F02-2475-HP600	30573128
25,00	25	QTD-2F02-2500-HP600	30573129
25,50	25	QTD-2F02-2550-HP600	30573131
25,70	25	QTD-2F02-2570-HP600	30573132
26,00	26	QTD-2F02-2600-HP600	30573133
26,50	26	QTD-2F02-2650-HP600	30573134
27,00	27	QTD-2F02-2700-HP600	30573135

d ₁ from 27.50 to 40.00			
d ₁ h7	Tool holder size D	Specification	Order no.
27,50	27	QTD-2F02-2750-HP600	30573136
28,00	28	QTD-2F02-2800-HP600	30573138
29,00	29	QTD-2F02-2900-HP600	30573141
29,50	29	QTD-2F02-2950-HP600	30573142
30,00	30	QTD-2F02-3000-HP600	30573143
30,75	30	QTD-2F02-3075-HP600	30573146
33,00	33	QTD-2F02-3300-HP600	30649662
36,00	36	QTD-2F02-3600-HP600	30649665
37,00	37	QTD-2F02-3700-HP600	30649666
40,00	39	QTD-2F02-4000-HP600	30657246

Configurable features



Diameter:
Diameter in increments of 0.01 mm freely selectable

Specification:
QTD-2F02-[diameter]-HP600

Dimensions of configurable series

d ₁ min.	d ₁ max.
9,00	50,00

Example:

QTD-2F02-1401-HP600

Tool diameter d₁ = 14.01 mm

QTD indexable inserts

Produced from solid carbide, internal coolant supply
Type 04 - Iron

Design:

Drill diameter: 9.00 - 50.00 mm
Bore tolerance: $\geq IT 10$
Cutting material: HP240
Number of cutting edges: 2
Number of guiding chamfers: 2
Tip angle: 135°

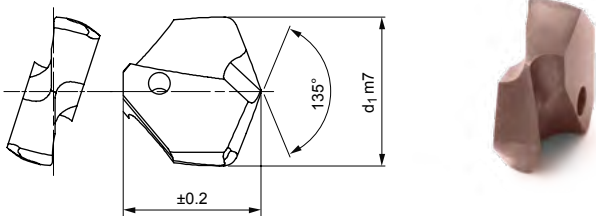

Stocked preferred series

d ₁ from 12.00 to 23.00			
d ₁ m7	Tool holder size D	Specification	Order no.
12,00	12	QTD-2F04-1200-HP240	30615805
14,00	14	QTD-2F04-1400-HP240	30612900
14,50	14,5	QTD-2F04-1450-HP240	30612901
17,00	17	QTD-2F04-1700-HP240	30612915
17,50	17	QTD-2F04-1750-HP240	30612916
18,00	18	QTD-2F04-1800-HP240	30612918
19,00	19	QTD-2F04-1900-HP240	30612922
19,10	19	QTD-2F04-1910-HP240	30646366
19,50	19	QTD-2F04-1950-HP240	30612926
20,50	20	QTD-2F04-2050-HP240	30612931
21,00	21	QTD-2F04-2100-HP240	30612934
21,50	21	QTD-2F04-2150-HP240	30612935
22,00	22	QTD-2F04-2200-HP240	30612937
23,00	23	QTD-2F04-2300-HP240	30612943

d ₁ from 23.50 to 33.00			
d ₁ m7	Tool holder size D	Specification	Order no.
23,50	23	QTD-2F04-2350-HP240	30612945
24,00	24	QTD-2F04-2400-HP240	30612949
24,50	24	QTD-2F04-2450-HP240	30612950
25,00	25	QTD-2F04-2500-HP240	30612953
25,70	25	QTD-2F04-2570-HP240	30612956
26,00	26	QTD-2F04-2600-HP240	30612957
26,50	26	QTD-2F04-2650-HP240	30612958
28,00	28	QTD-2F04-2800-HP240	30612962
28,50	28	QTD-2F04-2850-HP240	30612964
29,00	29	QTD-2F04-2900-HP240	30612965
29,50	29	QTD-2F04-2950-HP240	30612966
30,00	30	QTD-2F04-3000-HP240	30612967
31,00	31	QTD-2F04-3100-HP240	30612971
33,00	33	QTD-2F04-3300-HP240	30649674

Configurable features



Diameter:
Diameter in increments of 0.01 mm freely selectable



Specification:
QTD-2F02-[diameter]-HP600

Dimensions of configurable series

d ₁ min.	d ₁ max.
9,00	50,00

Example:

QTD-2F02-1401-HP600

Tool diameter d₁ = 14.01 mm

Dimensions in mm.

For cutting data recommendations, see end of chapter.

Special designs and other coatings available upon request.

QTD indexable inserts

Produced from solid carbide, internal coolant supply
Type 03 - Alu

Design:

Drill diameter: 9.00 - 50.00 mm
Bore tolerance: \geq IT 10
Cutting material: HU310
Number of cutting edges: 2
Number of guiding chamfers: 2
Tip angle: 135°

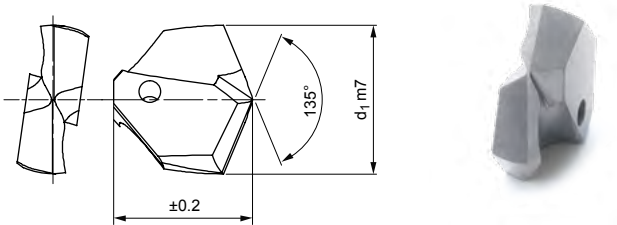

Stocked preferred series

d ₁ from 13.00 to 20.50			
d ₁ m7	Tool holder size D	Specification	Order no.
13,00	13	QTD-2F03-1300-HU310	30612819
13,50	13,5	QTD-2F03-1350-HU310	30612820
14,00	14	QTD-2F03-1400-HU310	30612822
14,50	14,5	QTD-2F03-1450-HU310	30612823
15,00	15	QTD-2F03-1500-HU310	30612826
15,50	15	QTD-2F03-1550-HU310	30612828
16,00	16	QTD-2F03-1600-HU310	30612830
17,00	17	QTD-2F03-1700-HU310	30612837
17,50	17	QTD-2F03-1750-HU310	30612838
18,25	18	QTD-2F03-1825-HU310	30612841
18,50	18	QTD-2F03-1850-HU310	30612842
19,00	19	QTD-2F03-1900-HU310	30612844
20,00	20	QTD-2F03-2000-HU310	30612851
20,50	20	QTD-2F03-2050-HU310	30612853

d ₁ from 21.00 to 36.00			
d ₁ m7	Tool holder size D	Specification	Order no.
21,00	21	QTD-2F03-2100-HU310	30612856
22,00	22	QTD-2F03-2200-HU310	30612859
22,50	22	QTD-2F03-2250-HU310	30612862
23,00	23	QTD-2F03-2300-HU310	30612865
23,50	23	QTD-2F03-2350-HU310	30612867
24,00	24	QTD-2F03-2400-HU310	30612871
24,50	24	QTD-2F03-2450-HU310	30612872
25,00	25	QTD-2F03-2500-HU310	30612875
26,00	26	QTD-2F03-2600-HU310	30612879
27,00	27	QTD-2F03-2700-HU310	30612881
29,50	29	QTD-2F03-2950-HU310	30612888
30,00	30	QTD-2F03-3000-HU310	30612889
34,00	34	QTD-2F03-3400-HU310	30649669
36,00	36	QTD-2F03-3600-HU310	30649671

Configurable features



Diameter:
Diameter in increments of 0.01 mm freely selectable



Specification:
QTD-2F03-[diameter]-HU310

Dimensions of configurable series

d ₁ min.	d ₁ max.
9,00	50,00

Example:

QTD-2F02-1401-HU310

Tool diameter d₁ = 14.01 mm

Dimensions in mm.

For cutting data recommendations, see end of chapter.

Special designs and other coatings available upon request.

QTS indexable insert holder

With prism mounting for QTD indexable inserts
QTS100S, internal coolant supply

Design:

For diameter:

9.00 - 42.99 mm

Shank form:

According to ISO
9766

Changing system:

Prism mounting,
possible to replace
cutting edges on the
machine

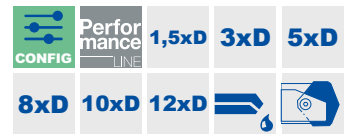
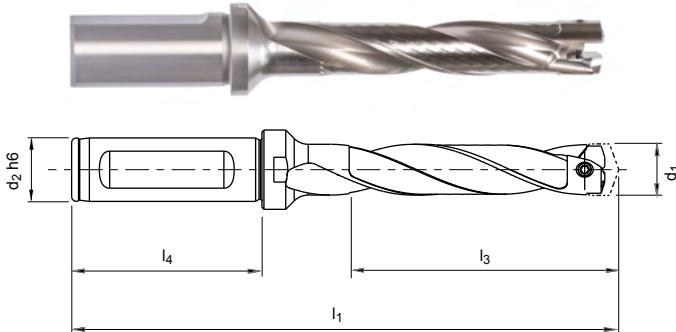

Stocked preferred series

Dimensions								
Tool holder size D	Diameter range Indexable insert d_1	d_2 h6	l_1	l_3	l_4	Specification	Order no.	
9,00	9,00 - 9,49	12	110	48	45	QTS100S-0900-DR05-ZYL12-MN	30605484	
9,50	9,50 - 9,99	12	113	50	45	QTS100S-0950-DR05-ZYL12-MN	30605485	
10,00	10,00 - 10,49	16	99	32	48	QTS100S-1000-DR03-ZYL16-MN	30605476	
10,00	10,00 - 10,49	16	120	53	48	QTS100S-1000-DR05-ZYL16-MN	30605486	
10,50	10,50 - 10,99	16	122	55	48	QTS100S-1050-DR05-ZYL16-MN	30605487	
11,00	11,00 - 11,49	16	126	58	48	QTS100S-1100-DR05-ZYL16-MN	30605488	
11,00	11,00 - 11,49	16	160	92	48	QTS100S-1100-DR08-ZYL16-MN	30605498	
11,50	11,50 - 11,99	16	105	36	48	QTS100S-1150-DR03-ZYL16-MN	30605479	
12,00	12,00 - 12,49	16	107	38	48	QTS100S-1200-DR03-ZYL16-MN	30605480	
12,00	12,00 - 12,49	16	132	63	48	QTS100S-1200-DR05-ZYL16-MN	30605490	
12,00	12,00 - 12,49	16	169	100	48	QTS100S-1200-DR08-ZYL16-MN	30605500	
12,50	12,50 - 12,99	16	109	39	48	QTS100S-1250-DR03-ZYL16-MN	30605481	
12,50	12,50 - 12,99	16	135	65	48	QTS100S-1250-DR05-ZYL16-MN	30605491	
12,50	12,50 - 12,99	16	174	104	48	QTS100S-1250-DR08-ZYL16-MN	30605501	
13,00	13,00 - 13,49	16	112	41	48	QTS100S-1300-DR03-ZYL16-MN	30572922	
13,00	13,00 - 13,49	16	138	68	48	QTS100S-1300-DR05-ZYL16-MN	30572945	
13,00	13,00 - 13,49	16	178	108	48	QTS100S-1300-DR08-ZYL16-MN	30572967	
13,00	13,00 - 13,49	16	232	162	48	QTS100S-1300-DR12-ZYL16-MN	30598728	
13,50	13,50 - 13,99	16	211	140	48	QTS100S-1350-DR10-ZYL16-MN	30826051	
13,50	13,50 - 13,99	16	239	168	48	QTS100S-1350-DR12-ZYL16-MN	30598729	
14,00	14,00 - 14,49	16	116	44	48	QTS100S-1400-DR03-ZYL16-MN	30572924	
14,00	14,00 - 14,49	16	144	73	48	QTS100S-1400-DR05-ZYL16-MN	30572947	
14,00	14,00 - 14,49	16	187	116	48	QTS100S-1400-DR08-ZYL16-MN	30572970	
14,00	14,00 - 14,49	16	245	174	48	QTS100S-1400-DR12-ZYL16-MN	30598730	
14,50	14,50 - 14,99	16	95	23	48	QTS100S-1450-DR01-ZYL16-MN	30572903	
14,50	14,50 - 14,99	16	147	75	48	QTS100S-1450-DR05-ZYL16-MN	30572948	
15,00	15,00 - 15,99	20	124	48	50	QTS100S-1500-DR03-ZYL20-MN	30572926	
15,00	15,00 - 15,99	20	155	80	50	QTS100S-1500-DR05-ZYL20-MN	30572949	
15,00	15,00 - 15,99	20	203	128	50	QTS100S-1500-DR08-ZYL20-MN	30572972	
15,00	15,00 - 15,99	20	237	162	50	QTS100S-1500-DR10-ZYL20-MN	30826054	
15,00	15,00 - 15,99	20	267	192	50	QTS100S-1500-DR12-ZYL20-MN	30598732	
16,00	16,00 - 16,99	20	102	26	50	QTS100S-1600-DR01-ZYL20-MN	30572905	
16,00	16,00 - 16,99	20	128	51	50	QTS100S-1600-DR03-ZYL20-MN	30572927	
16,00	16,00 - 16,99	20	161	85	50	QTS100S-1600-DR05-ZYL20-MN	30572950	

Continued on next page.

QTS indexable insert holder | QTS100, internal coolant supply

Dimensions						Specification	Order no.
Tool holder size D	Diameter range Indexable insert d ₁	d ₂ h6	l ₁	l ₃	l ₄		
16,00	16,00 - 16,99	20	212	136	50	QTS100S-1600-DR08-ZYL20-MN	30572973
16,00	16,00 - 16,99	20	246	170	50	QTS100S-1600-DR10-ZYL20-MN	30826055
17,00	17,00 - 17,99	20	105	27	50	QTS100S-1700-DR01-ZYL20-MN	30572906
17,00	17,00 - 17,99	20	132	54	50	QTS100S-1700-DR03-ZYL20-MN	30572928
17,00	17,00 - 17,99	20	168	90	50	QTS100S-1700-DR05-ZYL20-MN	30572951
17,00	17,00 - 17,99	20	222	144	50	QTS100S-1700-DR08-ZYL20-MN	30572974
17,00	17,00 - 17,99	20	258	180	50	QTS100S-1700-DR10-ZYL20-MN	30826056
17,00	17,00 - 17,99	20	294	216	50	QTS100S-1700-DR12-ZYL20-MN	30598734
18,00	18,00 - 18,99	25	142	57	56	QTS100S-1800-DR03-ZYL25-MN	30572929
18,00	18,00 - 18,99	25	180	95	56	QTS100S-1800-DR05-ZYL25-MN	30572952
18,00	18,00 - 18,99	25	237	152	56	QTS100S-1800-DR08-ZYL25-MN	30572975
18,00	18,00 - 18,99	25	313	228	56	QTS100S-1800-DR12-ZYL25-MN	30598735
19,00	19,00 - 19,99	25	116	30	56	QTS100S-1900-DR01-ZYL25-MN	30572908
19,00	19,00 - 19,99	25	146	60	56	QTS100S-1900-DR03-ZYL25-MN	30572930
19,00	19,00 - 19,99	25	186	100	56	QTS100S-1900-DR05-ZYL25-MN	30572953
19,00	19,00 - 19,99	25	246	160	56	QTS100S-1900-DR08-ZYL25-MN	30572976
20,00	20,00 - 20,99	25	151	63	56	QTS100S-2000-DR03-ZYL25-MN	30572931
20,00	20,00 - 20,99	25	192	105	56	QTS100S-2000-DR05-ZYL25-MN	30572954
20,00	20,00 - 20,99	25	255	168	56	QTS100S-2000-DR08-ZYL25-MN	30572977
20,00	20,00 - 20,99	25	297	210	56	QTS100S-2000-DR10-ZYL25-MN	30826059
20,00	20,00 - 20,99	25	339	252	56	QTS100S-2000-DR12-ZYL25-MN	30598737
21,00	21,00 - 21,99	25	121	33	56	QTS100S-2100-DR01-ZYL25-MN	30572910
21,00	21,00 - 21,99	25	155	66	56	QTS100S-2100-DR03-ZYL25-MN	30572932
21,00	21,00 - 21,99	25	198	110	56	QTS100S-2100-DR05-ZYL25-MN	30572955
21,00	21,00 - 21,99	25	264	176	56	QTS100S-2100-DR08-ZYL25-MN	30572978
21,00	21,00 - 21,99	25	308	220	56	QTS100S-2100-DR10-ZYL25-MN	30826060
22,00	22,00 - 22,99	25	125	35	56	QTS100S-2200-DR01-ZYL25-MN	30572911
22,00	22,00 - 22,99	25	159	69	56	QTS100S-2200-DR03-ZYL25-MN	30572933
22,00	22,00 - 22,99	25	205	115	56	QTS100S-2200-DR05-ZYL25-MN	30572956
22,00	22,00 - 22,99	25	274	184	56	QTS100S-2200-DR08-ZYL25-MN	30572979
23,00	23,00 - 23,99	25	127	36	56	QTS100S-2300-DR01-ZYL25-MN	30572912
23,00	23,00 - 23,99	25	211	120	56	QTS100S-2300-DR05-ZYL25-MN	30572957
23,00	23,00 - 23,99	25	379	288	56	QTS100S-2300-DR12-ZYL25-MN	30598740
24,00	24,00 - 24,99	32	171	75	60	QTS100S-2400-DR03-ZYL32-MN	30572935
24,00	24,00 - 24,99	32	221	125	60	QTS100S-2400-DR05-ZYL32-MN	30572958
24,00	24,00 - 24,99	32	296	200	60	QTS100S-2400-DR08-ZYL32-MN	30572981
24,00	24,00 - 24,99	32	396	300	60	QTS100S-2400-DR12-ZYL32-MN	30598741
25,00	25,00 - 25,99	32	136	39	60	QTS100S-2500-DR01-ZYL32-MN	30572914
25,00	25,00 - 25,99	32	176	78	60	QTS100S-2500-DR03-ZYL32-MN	30572937
25,00	25,00 - 25,99	32	227	130	60	QTS100S-2500-DR05-ZYL32-MN	30572959
25,00	25,00 - 25,99	32	305	208	60	QTS100S-2500-DR08-ZYL32-MN	30572982
25,00	25,00 - 25,99	32	409	312	60	QTS100S-2500-DR12-ZYL32-MN	30598742
26,00	26,00 - 26,99	32	139	41	60	QTS100S-2600-DR01-ZYL32-MN	30572915
26,00	26,00 - 26,99	32	180	81	60	QTS100S-2600-DR03-ZYL32-MN	30572938
26,00	26,00 - 26,99	32	233	135	60	QTS100S-2600-DR05-ZYL32-MN	30572960
26,00	26,00 - 26,99	32	314	216	60	QTS100S-2600-DR08-ZYL32-MN	30572983
26,00	26,00 - 26,99	32	368	270	60	QTS100S-2600-DR10-ZYL32-MN	30826065
27,00	27,00 - 27,99	32	184	84	60	QTS100S-2700-DR03-ZYL32-MN	30572939
27,00	27,00 - 27,99	32	324	224	60	QTS100S-2700-DR08-ZYL32-MN	30572984
28,00	28,00 - 28,99	32	188	87	60	QTS100S-2800-DR03-ZYL32-MN	30572940
28,00	28,00 - 28,99	32	246	145	60	QTS100S-2800-DR05-ZYL32-MN	30572962
28,00	28,00 - 28,99	32	449	348	60	QTS100S-2800-DR12-ZYL32-MN	30598745
29,00	29,00 - 29,99	32	402	300	60	QTS100S-2900-DR10-ZYL32-MN	30826068
30,00	30,00 - 30,99	32	197	93	60	QTS100S-3000-DR03-ZYL32-MN	30572942
30,00	30,00 - 30,99	32	351	248	60	QTS100S-3000-DR08-ZYL32-MN	30572987
30,00	30,00 - 30,99	32	413	310	60	QTS100S-3000-DR10-ZYL32-MN	30826069

QTS indexable insert holder | QTS100, internal coolant supply

Dimensions							Specification	Order no.
Tool holder size D	Diameter range Indexable insert d ₁	d ₂ h6	l ₁	l ₃	l ₄			
30,00	30,00 - 30,99	32	475	372	60		QTS100S-3000-DR12-ZYL32-MN	30598747
31,00	31,00 - 31,99	32	264	160	60		QTS100S-3100-DR05-ZYL32-MN	30572965
32,00	32,00 - 32,99	32	271	165	60		QTS100S-3200-DR05-ZYL32-MN	30572966
32,00	32,00 - 32,99	32	436	330	60		QTS100S-3200-DR10-ZYL32-MN	30826071
32,00	32,00 - 32,99	32	502	396	60		QTS100S-3200-DR12-ZYL32-MN	30598749
33,00	33,00 - 33,99	32	209	102	60		QTS100S-3300-DR03-ZYL32-MN	30639167
34,00	34,00 - 34,99	32	283	175	60		QTS100S-3400-DR05-ZYL32-MN	30639172
35,00	35,00 - 35,99	32	218	108	60		QTS100S-3500-DR03-ZYL32-MN	30639169
36,00	36,00 - 36,99	32	222	111	60		QTS100S-3600-DR03-ZYL32-MN	30639170
37,00	37,00 - 38,99	40	318	195	70		QTS100S-3700-DR05-ZYL40-MN	30650288
39,00	39,00 - 40,99	40	249	123	70		QTS100S-3900-DR03-ZYL40-MN	30650284
41,00	41,00 - 42,99	40	257	129	70		QTS100S-4100-DR03-ZYL40-MN	30650285

Configurable features

Length version:
DR01 | DR03 | DR05 | DR08 |
DR10 | DR12

Specification:
QTS100S-3500-[Length version]-ZYL32-MN

Example:
QTS100S-3500-DR10-ZYL32-MN

Length version 10xD

Dimensions of configurable series

Tool holder size D	Diameter range Indexable insert d ₁	d ₂ h6	l ₄	DR01		DR03		DR05		DR08		DR10		DR12		Specification
				l ₁	l ₃	l ₁	l ₃	l ₁	l ₃	l ₁	l ₃	l ₁	l ₃	l ₁	l ₃	
9	9,00 - 9,49	12	45	77	15	92	29	110	48	138	76	-	-	-	-	QTS100S-0900-[Length version]-ZYL12-MN
9,5	9,50 - 9,99	12	45	78	15	93	30	113	50	143	80	-	-	-	-	QTS100S-0950-[Length version]-ZYL12-MN
10	10,00 - 10,49	16	48	83	16	99	32	120	53	151	84	-	-	-	-	QTS100S-1000-[Length version]-ZYL16-MN
10,5	10,50 - 10,99	16	48	84	17	101	33	122	55	155	88	-	-	-	-	QTS100S-1050-[Length version]-ZYL16-MN
11	11,00 - 11,49	16	48	86	18	103	35	126	58	160	92	-	-	-	-	QTS100S-1100-[Length version]-ZYL16-MN
11,5	11,50 - 11,99	16	48	86	18	105	36	128	60	164	96	-	-	-	-	QTS100S-1150-[Length version]-ZYL16-MN
12	12,00 - 12,49	16	48	88	19	107	38	132	63	169	100	-	-	-	-	QTS100S-1200-[Length version]-ZYL16-MN
12,5	12,50 - 12,99	16	48	90	20	109	39	135	65	174	104	-	-	-	-	QTS100S-1250-[Length version]-ZYL16-MN
13	13,00 - 13,49	16	48	91	21	112	41	138	68	178	108	205	135	232	162	QTS100S-1300-[Length version]-ZYL16-MN
13,5	13,50 - 13,99	16	48	92	21	113	42	141	70	183	112	211	140	239	168	QTS100S-1350-[Length version]-ZYL16-MN
14	14,00 - 14,49	16	48	93	22	116	44	144	73	187	116	216	145	245	174	QTS100S-1400-[Length version]-ZYL16-MN
14,5	14,50 - 14,99	16	48	95	23	117	45	147	75	192	120	222	150	252	180	QTS100S-1450-[Length version]-ZYL16-MN
15	15,00 - 15,99	20	50	99	24	124	48	155	80	203	128	237	162	267	192	QTS100S-1500-[Length version]-ZYL20-MN
16	16,00 - 16,99	20	50	102	26	128	51	161	85	212	136	246	170	280	204	QTS100S-1600-[Length version]-ZYL20-MN
17	17,00 - 17,99	20	50	105	27	132	54	168	90	222	144	258	180	294	216	QTS100S-1700-[Length version]-ZYL20-MN
18	18,00 - 18,99	25	56	114	29	142	57	180	95	237	152	275	190	313	228	QTS100S-1800-[Length version]-ZYL25-MN
19	19,00 - 19,99	25	56	116	30	146	60	186	100	246	160	286	200	326	240	QTS100S-1900-[Length version]-ZYL25-MN
20	20,00 - 20,99	25	56	119	32	151	63	192	105	255	168	297	210	339	252	QTS100S-2000-[Length version]-ZYL25-MN
21	21,00 - 21,99	25	56	121	33	155	66	198	110	264	176	308	220	352	264	QTS100S-2100-[Length version]-ZYL25-MN
22	22,00 - 22,99	25	56	125	35	159	69	205	115	274	184	320	230	366	276	QTS100S-2200-[Length version]-ZYL25-MN
23	23,00 - 23,99	25	56	127	36	163	72	211	120	283	192	331	240	379	288	QTS100S-2300-[Length version]-ZYL25-MN
24	24,00 - 24,99	32	60	134	38	171	75	221	125	296	200	346	250	396	300	QTS100S-2400-[Length version]-ZYL32-MN
25	25,00 - 25,99	32	60	136	39	176	78	227	130	305	208	357	260	409	312	QTS100S-2500-[Length version]-ZYL32-MN
26	26,00 - 26,99	32	60	139	41	180	81	233	135	314	216	368	270	422	324	QTS100S-2600-[Length version]-ZYL32-MN
27	27,00 - 27,99	32	60	142	42	184	84	240	140	324	224	380	280	436	336	QTS100S-2700-[Length version]-ZYL32-MN

Continued on next page.

Dimensions of configurable series

Tool holder size D	Diameter range Indexable insert d ₁	d ₂ h ₆	l ₄	DR01		DR03		DR05		DR08		DR10		DR12		Specification
				l ₁	l ₃	l ₁	l ₃	l ₁	l ₃	l ₁	l ₃	l ₁	l ₃	l ₁	l ₃	
28	28,00 - 28,99	32	60	145	44	188	87	246	145	333	232	391	290	449	348	QTS100S-2800-[Length version]-ZYL32-MN
29	29,00 - 29,99	32	60	147	45	192	90	252	150	342	240	402	300	462	360	QTS100S-2900-[Length version]-ZYL32-MN
30	30,00 - 30,99	32	60	150	47	197	93	258	155	351	248	413	310	475	372	QTS100S-3000-[Length version]-ZYL32-MN
31	31,00 - 31,99	32	60	152	48	201	96	264	160	360	256	424	320	488	384	QTS100S-3100-[Length version]-ZYL32-MN
32	32,00 - 32,99	32	60	156	50	205	99	271	165	370	264	436	330	502	396	QTS100S-3200-[Length version]-ZYL32-MN
33	33,00 - 33,99	32	60	158	51	209	102	277	170	379	272	447	340	515	408	QTS100S-3300-[Length version]-ZYL32-MN
34	34,00 - 34,99	32	60	161	53	213	105	283	175	388	280	458	350	528	420	QTS100S-3400-[Length version]-ZYL32-MN
35	35,00 - 35,99	32	60	163	54	218	108	289	180	397	288	469	360	541	432	QTS100S-3500-[Length version]-ZYL32-MN
36	36,00 - 36,99	32	60	166	56	222	111	295	185	406	296	480	370	554	444	QTS100S-3600-[Length version]-ZYL32-MN
37	37,00 - 38,99	40	70	182	59	240	117	318	195	435	312	515	390	591	468	QTS100S-3700-[Length version]-ZYL40-MN
39	39,00 - 40,99	40	70	187	62	249	123	330	205	453	328	537	410	617	492	QTS100S-3900-[Length version]-ZYL40-MN
41	41,00 - 42,99	40	70	193	65	257	129	343	215	472	344	560	430	644	516	QTS100S-4100-[Length version]-ZYL40-MN
43	43,00 - 44,99	40	70	198	68	265	135	355	225	490	360	582	440	670	540	QTS100S-4300-[Length version]-ZYL40-MN
45	45,00 - 46,99	40	70	203	71	274	141	367	235	508	376	604	470	696	564	QTS100S-4500-[Length version]-ZYL40-MN
47	47,00 - 48,99	40	70	211	74	284	147	382	245	529	392	627	490	725	588	QTS100S-4700-[Length version]-ZYL40-MN
49	49,00 - 50,99	40	70	216	77	293	153	394	255	547	408	649	510	751	612	QTS100S-4900-[Length version]-ZYL40-MN

Spare parts

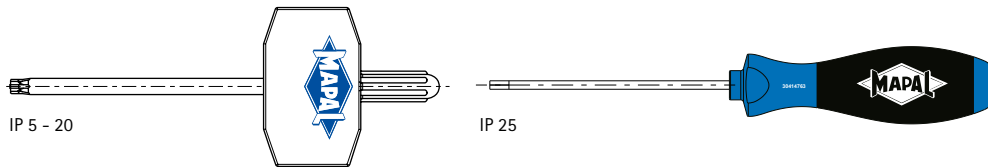

Screwdriver

Torx size TORX PLUS®	Order no.
5 IP	30584281
6 IP	30584282
7 IP	30584283
8 IP	30584284
9 IP	30584285
10 IP	30584286
15 IP	30584287
20 IP	30584288
25 IP	30414767

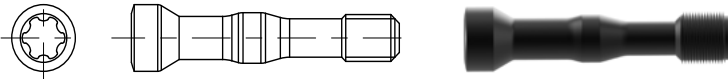

Clamping screw

Ø range	TORX PLUS® size	Order no.	Specification	Tightening torque [Nm]
8,00 - 8,99	5 IP	30604440	M1.2X7.5-TX5-IP	0,2
9,00 - 10,99	5 IP	30546309	M1.2X8.5-TX5-IP	0,2
11,00 - 12,99	6 IP	30604180	M1.6X10.5-TX6-IP	0,4
13,00 - 13,99	7 IP	30510826	M2x12-TX7-IP	0,6
14,00 - 15,99	8 IP	30510827	M2.2x13-TX8-IP	0,9
16,00 - 18,99	8 IP	30495432	M2.5x15-TX8-IP	1,2
19,00 - 21,99	9 IP	30510829	M3x18-TX9-IP	2,2
22,00 - 24,99	10 IP	30510830	M3.5x21-TX10-IP	3,3
25,00 - 27,99	15 IP	30510831	M4x24-TX15-IP	5,0
28,00 - 30,99	15 IP	30510832	M4.5x27-TX15-IP	5,7
31,00 - 32,99	20 IP	30510833	M5x30-TX20-IP	7,5
33,00 - 36,99	20 IP	30651830	M5X32-TX20-IP	7,5
37,00 - 44,99	25 IP	30651399	M6X35-TX25-IP	15,0
45,00 - 50,99	25 IP	30651510	M6X43-TX25-IP	15,0

Cutting data recommendations for QTD indexable inserts

Feed and cutting speed

Type 01 – Steel

MMG*		Workpiece material	Strength/hardness [N/mm ²] [HRC]
P	P1	P1.1 Structural, free-cutting, case hardened and heat-treated steels, non-alloy	< 700
		P1.2 Structural, free-cutting, case hardened and heat-treated steels, non-alloy	< 1,200
	P2	P2.1 Nitrided, case hardened and heat-treated steels, alloy	< 900
		P2.2 Nitrided, case hardened and heat-treated steels, alloy	< 1,400
	P3	P3.1 Tool, bearing, spring and high-speed steels**	< 800
		P3.2 Tool, bearing, spring and high-speed steels**	< 1,000
		P3.3 Tool, bearing, spring and high-speed steels**	< 1,500
	P5	P5.1 Cast steel	
	K	K1	K1.1 Cast iron with lamellar graphite (grey cast iron), GJL
K2.1 Cast iron with spheroidal graphite, GJS			< 500
K2		K2.2 Cast iron with spheroidal graphite, GJS	≤ 800
		K2.3 Cast iron with spheroidal graphite, GJS	> 800
K3		K3.1 Cast iron with spheroidal graphite, GJV; malleable cast iron, GJM	< 500
		K3.2 Cast iron with spheroidal graphite, GJV; malleable cast iron, GJM	> 500

Type 05 – Steel-Pyramid

MMG*		Workpiece material	Strength/hardness [N/mm ²] [HRC]	
P	P1	P1.1 Structural, free-cutting, case hardened and heat-treated steels, non-alloy	< 700	
		P1.2 Structural, free-cutting, case hardened and heat-treated steels, non-alloy	< 1,200	
	P2	P2.1 Nitrided, case hardened and heat-treated steels, alloy	< 900	
		P2.2 Nitrided, case hardened and heat-treated steels, alloy	< 1,400	
	P3	P3.1 Tool, bearing, spring and high-speed steels**	< 800	
		P3.2 Tool, bearing, spring and high-speed steels**	< 1,000	
		P3.3 Tool, bearing, spring and high-speed steels**	< 1,500	
	K	K1	K1.1 Cast iron with lamellar graphite (grey cast iron), GJL	< 300
			K2.1 Cast iron with spheroidal graphite, GJS	< 500
K2		K2.2 Cast iron with spheroidal graphite, GJS	≤ 800	
		K2.3 Cast iron with spheroidal graphite, GJS	> 800	

Type 10 – Uni, EK-shaped

MMG*		Workpiece material	Strength/hardness [N/mm ²] [HRC]
P	P1	P1.1 Structural, free-cutting, case hardened and heat-treated steels, non-alloy	< 700
		P1.2 Structural, free-cutting, case hardened and heat-treated steels, non-alloy	< 1200
	P2	P2.1 Nitrided, case hardened and heat-treated steels, alloy	< 900
		P2.2 Nitrided, case hardened and heat-treated steels, alloy	< 1400
	P3	P3.1 Tool, bearing, spring and high-speed steels**	< 800
		P3.2 Tool, bearing, spring and high-speed steels**	< 1000
		P3.3 Tool, bearing, spring and high-speed steels**	< 1500
	P5	P5.1 Cast steel	
	K	K1	K1.1 Cast iron with lamellar graphite (grey cast iron), GJL
K2		K2.1 Cast iron with spheroidal graphite, GJS	< 500

* MAPAL machining groups

** If the alloy parts Cr, Mo, Ni, V, W in total > 8% then select the next highest MAPAL machining group.

	Cutting speed v_c [m/min]				Feed f [mm] for drill diameter					
	Internal cooling	External cooling	MQL	Air	8.00	11.50	16.50	24.00	34.50	50.00
	100	90	90		0.20	0.26	0.31	0.36	0.38	0.39
	90	75	75		0.25	0.32	0.39	0.45	0.47	0.49
	100	85	85		0.24	0.30	0.37	0.43	0.45	0.46
	70	60	60		0.19	0.24	0.29	0.34	0.35	0.36
	75	65	65		0.22	0.27	0.33	0.38	0.40	0.42
	60	55	55		0.18	0.22	0.27	0.31	0.33	0.34
	60	45	50		0.14	0.18	0.21	0.24	0.25	0.26
	100	85	85		0.24	0.30	0.37	0.43	0.45	0.46
	95	70	70	70	0.25	0.33	0.41	0.47	0.49	0.51
	130	80	95	95	0.24	0.30	0.37	0.43	0.46	0.47
	80	60	60		0.21	0.26	0.32	0.37	0.39	0.40
	50	30	40		0.14	0.18	0.21	0.24	0.26	0.26
	70	65	65		0.22	0.28	0.35	0.40	0.42	0.43
	65	55	55		0.18	0.23	0.27	0.32	0.33	0.34

	Cutting speed v_c [m/min]				Feed f [mm] for drill diameter					
	Internal cooling	External cooling	MQL	Air	14.00	16.50	19.50	23.00	27.00	32.00
	120	110	110		0.26	0.29	0.31	0.33	0.34	0.34
	110	90	90		0.33	0.36	0.38	0.41	0.42	0.43
	120	100	100		0.31	0.34	0.36	0.38	0.40	0.41
	90	80	80		0.28	0.30	0.33	0.35	0.36	0.37
	95	70	70	70	0.39	0.43	0.46	0.49	0.51	0.52
	110	70	85	85	0.36	0.40	0.43	0.45	0.47	0.48

	Cutting speed v_c [m/min]				Feed f [mm] for drill diameter					
	Internal cooling	External cooling	MQL	Air	10,00	13,00	16,00	21,00	26,00	33,00
	120	110	110		0,22	0,25	0,28	0,31	0,34	0,35
	110	90	90		0,27	0,31	0,35	0,39	0,42	0,43
	120	100	100		0,25	0,29	0,33	0,37	0,40	0,41
	90	80	80		0,23	0,26	0,30	0,33	0,36	0,37
	95	70	70	70	0,31	0,36	0,42	0,47	0,51	0,52
	110	70	85	85	0,29	0,34	0,39	0,43	0,47	0,48

The specified cutting values are guide values.

The optimum data for the respective machining task should be determined during the test or machining.

Cutting data recommendations for QTD indexable inserts

Feed and cutting speed

Type 02 – Inox

MMG*		Workpiece material	Strength/hardness [N/mm ²] [HRC]	
P	P1	P1.1 Structural, free-cutting, case hardened and heat-treated steels, non-alloy	< 700	
		P1.2 Structural, free-cutting, case hardened and heat-treated steels, non-alloy	< 1,200	
	P2	P2.1 Nitrided, case hardened and heat-treated steels, alloy	< 900	
		P2.2 Nitrided, case hardened and heat-treated steels, alloy	< 1,400	
	P3	P3.1 Tool, bearing, spring and high-speed steels**	< 800	
		P3.2 Tool, bearing, spring and high-speed steels**	< 1,000	
		P3.3 Tool, bearing, spring and high-speed steels**	< 1,500	
	P4	P4.1 Stainless steels, ferritic and martensitic		
	P5	P5.1 Cast steel		
	P6	P6.1 Stainless cast steel, ferritic and martensitic		
M	M1	M1.1 Stainless steels, austenitic	< 700	
		M1.2 Stainless steels, ferritic/austenitic (duplex)	< 1,000	
	M2	M2.1 Stainless/heat-resistant cast steel, austenitic	< 700	
	M3	M3.1 Stainless cast steel, ferritic/austenitic (duplex)	< 1,000	
K	K1	K1.1 Cast iron with lamellar graphite (grey cast iron), GJL	< 300	
		K2.1 Cast iron with spheroidal graphite, GJS	< 500	
		K2.2 Cast iron with spheroidal graphite, GJS	≤ 800	
	K2	K2.3 Cast iron with spheroidal graphite, GJS	> 800	
		K3.1	K3.1 Cast iron with spheroidal graphite, GJV; malleable cast iron, GJM	< 500
			K3.2 Cast iron with spheroidal graphite, GJV; malleable cast iron, GJM	> 500

Type 03 – Alu

MMG*		Workpiece material	Strength/hardness [N/mm ²] [HRC]
N	N1	N1.1 Aluminium, non-alloy and alloy < 3 % Si	
		N1.2 Aluminium, alloy ≤ 7 % Si	
		N1.3 Aluminium, alloy > 7-12 % Si	
		N1.4 Aluminium, alloy > 12 % Si	
	N2	N2.1 Copper, non-alloy and low-alloy	< 300
		N2.2 Copper, alloy	> 300
		N2.3 Brass, bronze, gunmetal	< 1,200

Type 04 – Iron

MMG*		Workpiece material	Strength/hardness [N/mm ²] [HRC]	
K	K1	K1.1 Cast iron with lamellar graphite (grey cast iron), GJL	< 300	
		K2.1 Cast iron with spheroidal graphite, GJS	< 500	
		K2.2 Cast iron with spheroidal graphite, GJS	≤ 800	
	K2	K2.3 Cast iron with spheroidal graphite, GJS	> 800	
		K3.1	K3.1 Cast iron with spheroidal graphite, GJV; malleable cast iron, GJM	< 500
			K3.2 Cast iron with spheroidal graphite, GJV; malleable cast iron, GJM	> 500

* MAPAL machining groups

** If the alloy parts Cr, Mo, Ni, V, W in total > 8% then select the next highest MAPAL machining group.

	Cutting speed v_c [m/min]				Feed f [mm] for drill diameter					
	Internal cooling	External cooling	MLQ	Air	9.00	12.00	16.00	21.00	27.50	36.00
	100	90	90		0.19	0.23	0.27	0.30	0.32	0.33
	90	75	75		0.24	0.29	0.34	0.38	0.40	0.41
	100	85	85		0.23	0.27	0.32	0.36	0.38	0.39
	70	60	60		0.18	0.22	0.25	0.28	0.30	0.31
	75	65	65		0.20	0.24	0.29	0.32	0.34	0.35
	60	55	55		0.17	0.20	0.23	0.26	0.28	0.29
	60	45	50		0.13	0.16	0.18	0.20	0.21	0.22
	60	45	50		0.13	0.16	0.19	0.21	0.23	0.23
	100	85	85		0.23	0.27	0.32	0.36	0.38	0.39
	60	45	50		0.13	0.16	0.19	0.21	0.23	0.23
	55	35	35		0.15	0.18	0.22	0.24	0.26	0.27
	50	30	30		0.13	0.16	0.19	0.21	0.22	0.23
	55	35	35		0.15	0.18	0.22	0.24	0.26	0.27
	50	30	30		0.13	0.16	0.19	0.21	0.22	0.23
	110	75	75	75	0.27	0.34	0.40	0.45	0.49	0.50
	145	90	110	110	0.26	0.31	0.37	0.42	0.45	0.46
	90	70	70		0.22	0.27	0.32	0.36	0.38	0.39
	55	35	45		0.15	0.18	0.21	0.23	0.25	0.26
	80	70	70		0.24	0.29	0.34	0.38	0.41	0.42
	70	65	65		0.19	0.23	0.27	0.30	0.33	0.33

	Cutting speed v_c [m/min]				Feed f [mm] for drill diameter					
	Internal cooling	External cooling	MLQ	Air	9.00	12.00	16.00	21.00	27.50	36.00
	300	200	250		0.19	0.23	0.27	0.30	0.32	0.33
	250	180	200		0.25	0.30	0.35	0.40	0.43	0.43
	220	150	180		0.25	0.30	0.35	0.40	0.43	0.43
	180	120	150		0.25	0.30	0.35	0.40	0.43	0.43
	140	100			0.19	0.23	0.27	0.30	0.32	0.33
	120	90			0.25	0.30	0.35	0.40	0.43	0.43
	200	160	160	120	0.30	0.37	0.44	0.50	0.54	0.55

	Cutting speed v_c [m/min]				Feed f [mm] for drill diameter					
	Internal cooling	External cooling	MLQ	Air	9.00	12.00	16.00	21.00	27.50	36.00
	120	85	85	85	0.37	0.45	0.53	0.60	0.65	0.66
	160	100	120	120	0.34	0.42	0.49	0.55	0.59	0.61
	100	75	75		0.30	0.36	0.42	0.48	0.51	0.52
	60	40	50		0.20	0.24	0.28	0.31	0.34	0.34
	90	80	80		0.32	0.39	0.46	0.51	0.55	0.56
	80	70	70		0.26	0.31	0.36	0.40	0.43	0.44

The specified cutting values are guide values.

The optimum data for the respective machining task should be determined during the test or machining.

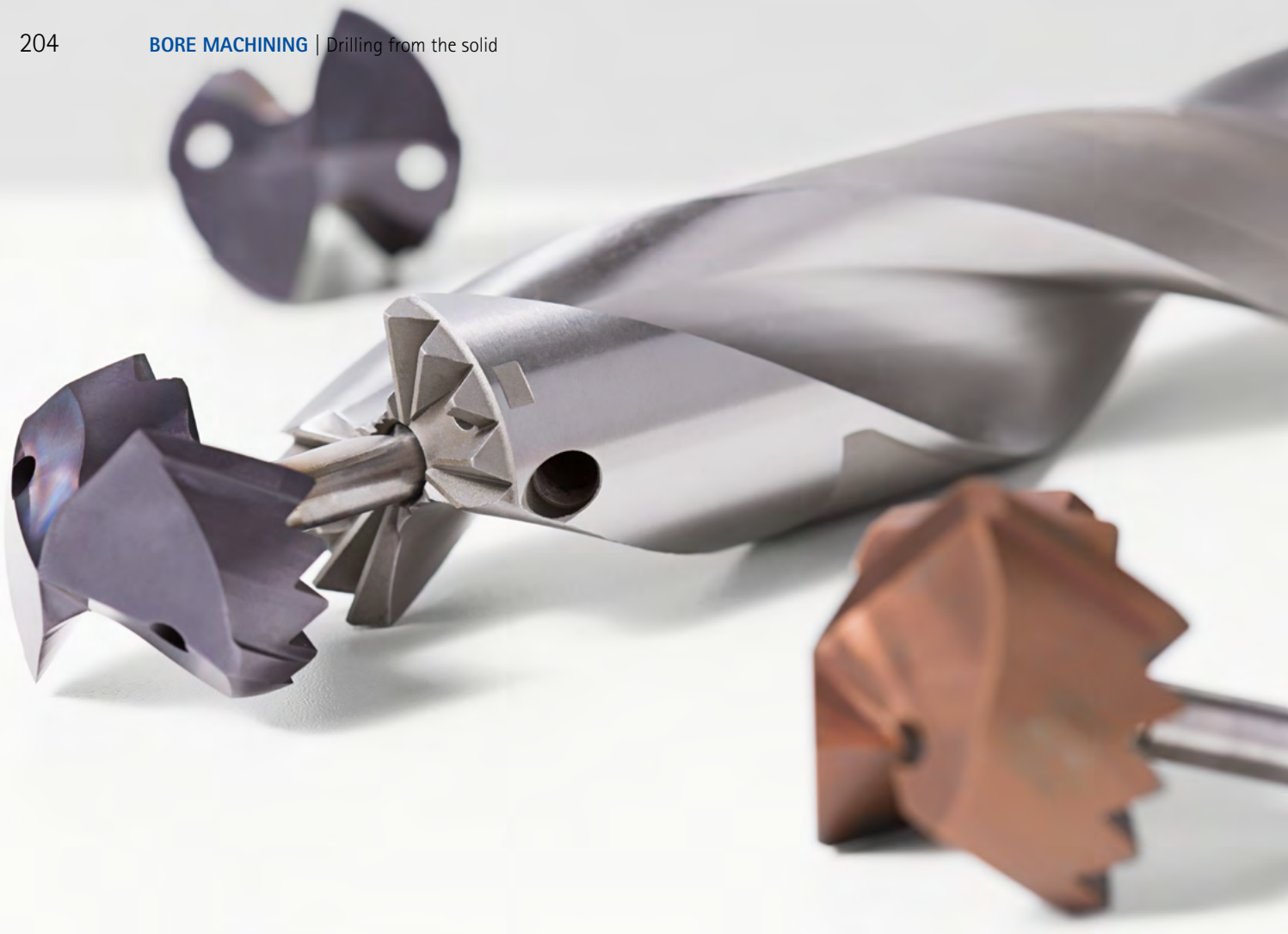

TTD REPLACEABLE HEAD DRILL

Minimised usage of carbide with highest stability and precision

The TTD replaceable head drill achieves the performance and quality level of solid carbide drills. At the same time, the reduction in the use of carbide metal for the replaceable drill heads means reduced tool costs.

The heart of the TTD replaceable head drill is the connection TTS (Torque Transfer System) that guarantees an extremely stable connection. It features optimal torque transmission and high changing and radial run-out accuracies.

The standard ranges of the TTD replaceable head drills cover the drilling depths 1xD, 3xD, 5xD, 8xD and 12xD. With five different types of replaceable drill head, even problematic machining tasks can be carried out in practically all workpiece materials in the diameter range from 12 mm to 45 mm.

The drill heads exhibit optimal centring properties. The chips are reliably discharged via the chip flutes of the TTS tool holder thanks to

the special facet geometry. In addition, very smooth running in the bore is enhanced by the special three- or four-chamfer geometry. The combination of these properties enables long tool lives and drilling results to be achieved at the highest level.

Tool features in detail



1 Three or four guiding chamfers

- Optimal guiding properties

2 TTS tool holder

- Universal carrier for all drill geometries

3 TTS connection

- Non-confusable Hirth serration



AT A GLANCE

- Available ex-stock
- \varnothing range 12.00 to 45.00 mm
- Drilling depths 1 | 3 | 5 | 8 and 12xD
- With internal cooling
- Easy handling
- Head replacement on the machine possible

PERFORMANCE FEATURES

- Identical performance as solid carbide drill
- High degree of radial run-out accuracy
- Good positioning accuracy
- High level of torque transmission

ADVANTAGES

- Can be reground if necessary
- Error-free head replacement
- One replaceable head holder for different drill heads
- Almost all bore geometries can be achieved

TTD replaceable drill head

Produced from solid carbide, internal coolant supply
Type 01P - Uni-Plus

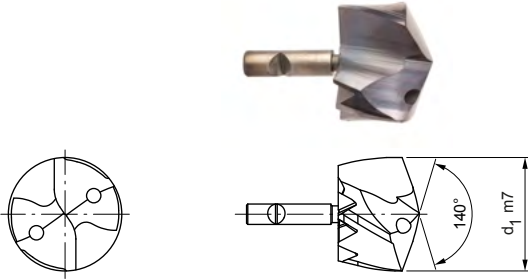

Design:

Drill diameter: 12.00 – 45.00 mm
Bore tolerance: ≥ IT 9
Cutting material: HP358
Number of cutting edges: 2
Number of guiding chamfers: 4
Tip angle: 140°



Stocked preferred series

d ₁ from 12.00 to 21.00		
d ₁ m7	Specification	Order no.
12,00	TTD-4F01P-1200-HP358	31164086
13,50	TTD-4F01P-1350-HP358	31164141
14,00	TTD-4F01P-1400-HP358	31164146
14,50	TTD-4F01P-1450-HP358	31164151
15,00	TTD-4F01P-1500-HP358	31164156
15,50	TTD-4F01P-1550-HP358	31164161
15,60	TTD-4F01P-1560-HP358	31164162
15,80	TTD-4F01P-1580-HP358	31164164
16,00	TTD-4F01P-1600-HP358	31164166
16,50	TTD-4F01P-1650-HP358	31164171
17,00	TTD-4F01P-1700-HP358	31164176
17,50	TTD-4F01P-1750-HP358	31164181
17,70	TTD-4F01P-1770-HP358	31164183
17,80	TTD-4F01P-1780-HP358	31164184
18,00	TTD-4F01P-1800-HP358	31164186
18,50	TTD-4F01P-1850-HP358	31164191
18,80	TTD-4F01P-1880-HP358	31164194
19,00	TTD-4F01P-1900-HP358	31164196
19,50	TTD-4F01P-1950-HP358	31164201
19,70	TTD-4F01P-1970-HP358	31164203
20,00	TTD-4F01P-2000-HP358	31164206
20,50	TTD-4F01P-2050-HP358	31164211
21,00	TTD-4F01P-2100-HP358	31164216

d ₁ from 21.50 to 40.00		
d ₁ m7	Specification	Order no.
21,50	TTD-4F01P-2150-HP358	31164221
22,00	TTD-4F01P-2200-HP358	31164226
22,50	TTD-4F01P-2250-HP358	31164231
23,00	TTD-4F01P-2300-HP358	31164236
24,00	TTD-4F01P-2400-HP358	31164246
24,50	TTD-4F01P-2450-HP358	31164251
25,00	TTD-4F01P-2500-HP358	31164256
25,40	TTD-4F01P-2540-HP358	31164260
25,50	TTD-4F01P-2550-HP358	31164261
26,00	TTD-4F01P-2600-HP358	31164266
26,50	TTD-4F01P-2650-HP358	31164271
27,00	TTD-4F01P-2700-HP358	31164276
28,00	TTD-4F01P-2800-HP358	31164286
28,50	TTD-4F01P-2850-HP358	31164291
30,00	TTD-4F01P-3000-HP358	31164306
30,70	TTD-4F01P-3070-HP358	31164313
31,00	TTD-4F01P-3100-HP358	31164316
32,00	TTD-4F01P-3200-HP358	31164326
33,00	TTD-4F01P-3300-HP358	31164328
37,00	TTD-4F01P-3700-HP358	31164336
38,50	TTD-4F01P-3850-HP358	31164339
39,00	TTD-4F01P-3900-HP358	31164340
40,00	TTD-4F01P-4000-HP358	31164342

Configurable features



Diameter:
Diameter in increments of 0.01 mm freely selectable



Specification:
TTD-4F01P-[diameter]-HP358

Dimensions of configurable series

d ₁ min.	d ₁ max.
12,00	45,00

Example:
TTD-4F01P-1401-HP358

Tool diameter d₁ = 14.01 mm

Dimensions in mm.
Special designs available upon request.

TTD replaceable drill head

Produced from solid carbide, internal coolant supply
Type 04 - Steel

Design:
 Drill diameter: 12.00 – 45.00 mm
 Bore tolerance: ≥ IT 9
 Cutting material: HP358
 Number of cutting edges: 2
 Number of guiding chamfers: 3
 Tip angle: 138°

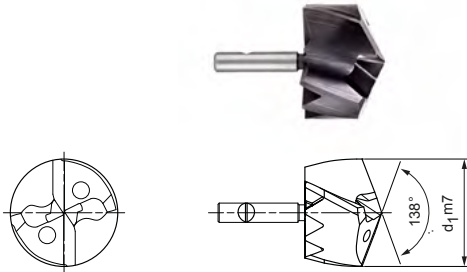

Stocked preferred series

d ₁ from 12.00 to 17.00		
d ₁ m7	Specification	Order no.
12,00	TTD-3F04-1200-HP358	30530406
12,10	TTD-3F04-1210-HP358	30596953
12,20	TTD-3F04-1220-HP358	30596954
12,50	TTD-3F04-1250-HP358	30530407
12,80	TTD-3F04-1280-HP358	30596958
13,00	TTD-3F04-1300-HP358	30530409
13,10	TTD-3F04-1310-HP358	30596960
13,20	TTD-3F04-1320-HP358	30596961
13,50	TTD-3F04-1350-HP358	30530410
14,00	TTD-3F04-1400-HP358	30530412
14,10	TTD-3F04-1410-HP358	30596967
14,20	TTD-3F04-1420-HP358	30596968
14,30	TTD-3F04-1430-HP358	30596969
14,40	TTD-3F04-1440-HP358	30596970
14,50	TTD-3F04-1450-HP358	30530413
14,70	TTD-3F04-1470-HP358	30530414
14,80	TTD-3F04-1480-HP358	30596972
15,00	TTD-3F04-1500-HP358	30530415
15,10	TTD-3F04-1510-HP358	30596974
15,20	TTD-3F04-1520-HP358	30596975
15,50	TTD-3F04-1550-HP358	30530416
15,70	TTD-3F04-1570-HP358	30530417
15,80	TTD-3F04-1580-HP358	30596979
16,00	TTD-3F04-1600-HP358	30530418
16,10	TTD-3F04-1610-HP358	30596981
16,20	TTD-3F04-1620-HP358	30596982
16,30	TTD-3F04-1630-HP358	30596983
16,40	TTD-3F04-1640-HP358	30596984
16,50	TTD-3F04-1650-HP358	30530419
16,60	TTD-3F04-1660-HP358	30596985
16,70	TTD-3F04-1670-HP358	30530420
16,80	TTD-3F04-1680-HP358	30596986
17,00	TTD-3F04-1700-HP358	30530421

d ₁ from 17.10 to 21.40		
d ₁ m7	Specification	Order no.
17,10	TTD-3F04-1710-HP358	30596988
17,30	TTD-3F04-1730-HP358	30596990
17,50	TTD-3F04-1750-HP358	30530422
17,60	TTD-3F04-1760-HP358	30596992
17,70	TTD-3F04-1770-HP358	30530423
17,80	TTD-3F04-1780-HP358	30596993
18,00	TTD-3F04-1800-HP358	30530424
18,10	TTD-3F04-1810-HP358	30596995
18,20	TTD-3F04-1820-HP358	30596996
18,30	TTD-3F04-1830-HP358	30596997
18,40	TTD-3F04-1840-HP358	30596998
18,50	TTD-3F04-1850-HP358	30530425
18,80	TTD-3F04-1880-HP358	30597000
18,90	TTD-3F04-1890-HP358	30597001
19,00	TTD-3F04-1900-HP358	30530427
19,20	TTD-3F04-1920-HP358	30597003
19,30	TTD-3F04-1930-HP358	30597004
19,50	TTD-3F04-1950-HP358	30530428
19,70	TTD-3F04-1970-HP358	30530429
19,80	TTD-3F04-1980-HP358	30597007
19,90	TTD-3F04-1990-HP358	30597008
20,00	TTD-3F04-2000-HP358	30530431
20,10	TTD-3F04-2010-HP358	30597009
20,20	TTD-3F04-2020-HP358	30597010
20,30	TTD-3F04-2030-HP358	30597011
20,40	TTD-3F04-2040-HP358	30597012
20,50	TTD-3F04-2050-HP358	30530432
20,60	TTD-3F04-2060-HP358	30597013
20,70	TTD-3F04-2070-HP358	30530433
21,00	TTD-3F04-2100-HP358	30530434
21,10	TTD-3F04-2110-HP358	30597016
21,20	TTD-3F04-2120-HP358	30597017
21,40	TTD-3F04-2140-HP358	30597019

Continued on next page.

Replaceable drill head TTD produced of solid carbide, internal coolant supply – type O4

d ₁ from 21.50 to 26.10		
d ₁ m7	Specification	Order no.
21,50	TTD-3F04-2150-HP358	30530435
21,70	TTD-3F04-2170-HP358	30530436
21,80	TTD-3F04-2180-HP358	30597021
22,00	TTD-3F04-2200-HP358	30530437
22,10	TTD-3F04-2210-HP358	30597023
22,20	TTD-3F04-2220-HP358	30597024
22,30	TTD-3F04-2230-HP358	30597025
22,40	TTD-3F04-2240-HP358	30597026
22,50	TTD-3F04-2250-HP358	30530438
22,60	TTD-3F04-2260-HP358	30597027
22,70	TTD-3F04-2270-HP358	30530439
23,00	TTD-3F04-2300-HP358	30530440
23,10	TTD-3F04-2310-HP358	30597030
23,30	TTD-3F04-2330-HP358	30597032
23,50	TTD-3F04-2350-HP358	30530441
23,70	TTD-3F04-2370-HP358	30530442
24,00	TTD-3F04-2400-HP358	30530443
24,40	TTD-3F04-2440-HP358	30597040
24,50	TTD-3F04-2450-HP358	30530444
24,70	TTD-3F04-2470-HP358	30530445
24,80	TTD-3F04-2480-HP358	30597042
25,00	TTD-3F04-2500-HP358	30530446
25,20	TTD-3F04-2520-HP358	30597045
25,30	TTD-3F04-2530-HP358	30597046
25,40	TTD-3F04-2540-HP358	30597047
25,50	TTD-3F04-2550-HP358	30530447
25,90	TTD-3F04-2590-HP358	30597050
26,00	TTD-3F04-2600-HP358	30530449
26,10	TTD-3F04-2610-HP358	30597051

d ₁ from 26.20 to 41.00		
d ₁ m7	Specification	Order no.
26,20	TTD-3F04-2620-HP358	30597052
26,50	TTD-3F04-2650-HP358	30530450
26,70	TTD-3F04-2670-HP358	30530451
27,00	TTD-3F04-2700-HP358	30530452
27,50	TTD-3F04-2750-HP358	30530453
27,70	TTD-3F04-2770-HP358	30530454
27,80	TTD-3F04-2780-HP358	30597063
28,00	TTD-3F04-2800-HP358	30530455
28,20	TTD-3F04-2820-HP358	30597066
28,30	TTD-3F04-2830-HP358	30597067
28,50	TTD-3F04-2850-HP358	30530456
29,00	TTD-3F04-2900-HP358	30530458
30,00	TTD-3F04-3000-HP358	30530461
30,30	TTD-3F04-3030-HP358	30597082
30,50	TTD-3F04-3050-HP358	30530462
31,00	TTD-3F04-3100-HP358	30530464
31,50	TTD-3F04-3150-HP358	30530465
31,70	TTD-3F04-3170-HP358	30530466
32,00	TTD-3F04-3200-HP358	30530467
33,00	TTD-3F04-3300-HP358	30530469
34,00	TTD-3F04-3400-HP358	30530471
34,50	TTD-3F04-3450-HP358	30530472
35,00	TTD-3F04-3500-HP358	30530473
36,00	TTD-3F04-3600-HP358	30530475
37,00	TTD-3F04-3700-HP358	30530477
38,00	TTD-3F04-3800-HP358	30530479
39,00	TTD-3F04-3900-HP358	30530481
40,00	TTD-3F04-4000-HP358	30530483
41,00	TTD-3F04-4100-HP358	30530485

Configurable features



Diameter:
Diameter in increments of 0.01 mm freely selectable



Specification:
TTD-3F04-[diameter]-HP358

Dimensions of configurable series

d ₁ min.	d ₁ max.
12,00	45,00

Example:
TTD-3F04-1401-HP358

Tool diameter d₁ = 14.01 mm

Dimensions in mm.

For cutting data recommendations, see end of chapter.

Special designs and other coatings available upon request.

TTD replaceable drill head

Produced from solid carbide, internal coolant supply
Type 02 - Inox

Design:

Drill diameter: 12.00 – 45.00 mm
Bore tolerance: ≥ IT 9
Cutting material: HP385
Number of cutting edges: 2
Number of guiding chamfers: 3
Tip angle: 138°

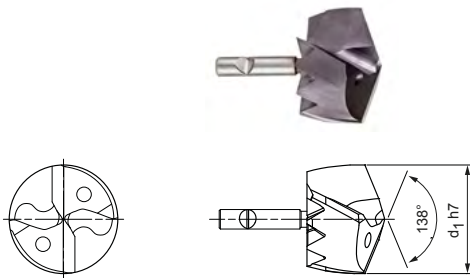

Stocked preferred series

d ₁ from 12.00 to 16.40		
d ₁ h7	Specification	Order no.
12,00	TTD-3F02-1200-HP385	30231780
12,10	TTD-3F02-1210-HP385	30248920
12,20	TTD-3F02-1220-HP385	30248921
12,40	TTD-3F02-1240-HP385	30248923
12,50	TTD-3F02-1250-HP385	30231784
12,60	TTD-3F02-1260-HP385	30248924
12,70	TTD-3F02-1270-HP385	30231787
13,00	TTD-3F02-1300-HP385	30231791
13,10	TTD-3F02-1310-HP385	30248927
13,50	TTD-3F02-1350-HP385	30231792
13,80	TTD-3F02-1380-HP385	30248932
14,00	TTD-3F02-1400-HP385	30231795
14,10	TTD-3F02-1410-HP385	30239446
14,20	TTD-3F02-1420-HP385	30248934
14,30	TTD-3F02-1430-HP385	30248935
14,40	TTD-3F02-1440-HP385	30248936
14,50	TTD-3F02-1450-HP385	30231802
14,60	TTD-3F02-1460-HP385	30248937
14,70	TTD-3F02-1470-HP385	30231804
14,80	TTD-3F02-1480-HP385	30248938
15,00	TTD-3F02-1500-HP385	30231805
15,10	TTD-3F02-1510-HP385	30248940
15,30	TTD-3F02-1530-HP385	30248942
15,50	TTD-3F02-1550-HP385	30231806
15,60	TTD-3F02-1560-HP385	30248944
15,70	TTD-3F02-1570-HP385	30219115
15,80	TTD-3F02-1580-HP385	30248945
15,90	TTD-3F02-1590-HP385	30248946
16,00	TTD-3F02-1600-HP385	30191427
16,10	TTD-3F02-1610-HP385	30248947
16,20	TTD-3F02-1620-HP385	30248948
16,30	TTD-3F02-1630-HP385	30248949
16,40	TTD-3F02-1640-HP385	30248950

d ₁ from 16.50 to 21.00		
d ₁ h7	Specification	Order no.
16,50	TTD-3F02-1650-HP385	30191428
16,60	TTD-3F02-1660-HP385	30248951
16,70	TTD-3F02-1670-HP385	30219122
16,80	TTD-3F02-1680-HP385	30248952
17,00	TTD-3F02-1700-HP385	30191429
17,50	TTD-3F02-1750-HP385	30191430
17,60	TTD-3F02-1760-HP385	30248958
17,70	TTD-3F02-1770-HP385	30219123
17,80	TTD-3F02-1780-HP385	30248959
18,00	TTD-3F02-1800-HP385	30191431
18,20	TTD-3F02-1820-HP385	30248962
18,30	TTD-3F02-1830-HP385	30248963
18,50	TTD-3F02-1850-HP385	30191432
18,60	TTD-3F02-1860-HP385	30248965
18,80	TTD-3F02-1880-HP385	30248966
18,90	TTD-3F02-1890-HP385	30248967
19,00	TTD-3F02-1900-HP385	30191433
19,10	TTD-3F02-1910-HP385	30248968
19,20	TTD-3F02-1920-HP385	30248969
19,30	TTD-3F02-1930-HP385	30248970
19,40	TTD-3F02-1940-HP385	30248971
19,50	TTD-3F02-1950-HP385	30191434
19,70	TTD-3F02-1970-HP385	30219125
19,80	TTD-3F02-1980-HP385	30248973
19,90	TTD-3F02-1990-HP385	30248974
20,00	TTD-3F02-2000-HP385	30191435
20,10	TTD-3F02-2010-HP385	30248975
20,20	TTD-3F02-2020-HP385	30248976
20,30	TTD-3F02-2030-HP385	30248977
20,40	TTD-3F02-2040-HP385	30248978
20,50	TTD-3F02-2050-HP385	30191436
20,70	TTD-3F02-2070-HP385	30219126
21,00	TTD-3F02-2100-HP385	30191437

Continued on next page.

Replaceable drill head TTD produced of solid carbide, internal coolant supply – type O2

d ₁ from 21.20 to 25.80			d ₁ from 26.00 to 38.50		
d ₁ h7	Specification	Order no.	d ₁ h7	Specification	Order no.
21,20	TTD-3F02-2120-HP385	30248982	26,00	TTD-3F02-2600-HP385	30191447
21,50	TTD-3F02-2150-HP385	30191438	26,50	TTD-3F02-2650-HP385	30191448
21,70	TTD-3F02-2170-HP385	30219127	26,80	TTD-3F02-2680-HP385	30249020
21,80	TTD-3F02-2180-HP385	30248986	27,00	TTD-3F02-2700-HP385	30191449
22,00	TTD-3F02-2200-HP385	30191439	27,10	TTD-3F02-2710-HP385	30249022
22,10	TTD-3F02-2210-HP385	30248988	27,40	TTD-3F02-2740-HP385	30249025
22,40	TTD-3F02-2240-HP385	30248990	27,50	TTD-3F02-2750-HP385	30191450
22,50	TTD-3F02-2250-HP385	30191440	28,00	TTD-3F02-2800-HP385	30191451
22,60	TTD-3F02-2260-HP385	30248991	28,10	TTD-3F02-2810-HP385	30249029
22,70	TTD-3F02-2270-HP385	30219128	28,20	TTD-3F02-2820-HP385	30249030
22,80	TTD-3F02-2280-HP385	30248992	28,50	TTD-3F02-2850-HP385	30191452
22,90	TTD-3F02-2290-HP385	30248993	28,60	TTD-3F02-2860-HP385	30249033
23,00	TTD-3F02-2300-HP385	30191441	28,70	TTD-3F02-2870-HP385	30219134
23,50	TTD-3F02-2350-HP385	30191442	29,00	TTD-3F02-2900-HP385	30191453
23,70	TTD-3F02-2370-HP385	30219129	29,50	TTD-3F02-2950-HP385	30191454
24,00	TTD-3F02-2400-HP385	30191443	29,70	TTD-3F02-2970-HP385	30219135
24,20	TTD-3F02-2420-HP385	30249002	29,80	TTD-3F02-2980-HP385	30249041
24,40	TTD-3F02-2440-HP385	30249004	29,90	TTD-3F02-2990-HP385	30249042
24,50	TTD-3F02-2450-HP385	30191444	30,00	TTD-3F02-3000-HP385	30191455
24,70	TTD-3F02-2470-HP385	30219130	30,10	TTD-3F02-3010-HP385	30249043
24,80	TTD-3F02-2480-HP385	30249006	30,30	TTD-3F02-3030-HP385	30249045
25,00	TTD-3F02-2500-HP385	30191445	31,00	TTD-3F02-3100-HP385	30191457
25,20	TTD-3F02-2520-HP385	30249009	31,30	TTD-3F02-3130-HP385	30249052
25,30	TTD-3F02-2530-HP385	30249010	31,50	TTD-3F02-3150-HP385	30191458
25,40	TTD-3F02-2540-HP385	30249011	31,80	TTD-3F02-3180-HP385	30249055
25,50	TTD-3F02-2550-HP385	30191446	32,00	TTD-3F02-3200-HP385	30191459
25,70	TTD-3F02-2570-HP385	30219131	38,50	TTD-3F02-3850-HP385	30322384
25,80	TTD-3F02-2580-HP385	30249013			

Configurable features



Diameter:
Diameter in increments of
0.01 mm freely selectable



Specification:

TTD-3F02-[diameter]-HP358

Dimensions of configurable series

d ₁ min.	d ₁ max.
12,00	45,00

Example:

TTD-3F02-1401-HP358

Tool diameter d₁ = 14.01 mm

Dimensions in mm.

For cutting data recommendations, see end of chapter.

Special designs and other coatings available upon request.

TTD replaceable drill head

Produced from solid carbide, internal coolant supply
Type 05 - Iron

Design:

Drill diameter: 12.00 – 45.00 mm
Bore tolerance: \geq IT 9
Cutting material: HP240
Number of cutting edges: 2
Number of guiding chamfers: 4
Tip angle: 140°

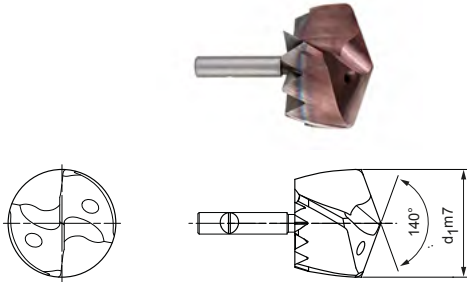

Stocked preferred series

d ₁ from 12.50 to 20.80		
d ₁ m7	Specification	Order no.
12,50	TTD-4F05-1250-HP240	30597144
12,70	TTD-4F05-1270-HP240	30597146
14,00	TTD-4F05-1400-HP240	30597159
14,50	TTD-4F05-1450-HP240	30597164
15,30	TTD-4F05-1530-HP240	30597173
15,70	TTD-4F05-1570-HP240	30597177
16,30	TTD-4F05-1630-HP240	30597183
16,50	TTD-4F05-1650-HP240	30597185
16,70	TTD-4F05-1670-HP240	30597187
16,80	TTD-4F05-1680-HP240	30597188
17,00	TTD-4F05-1700-HP240	30597190
17,10	TTD-4F05-1710-HP240	30597191
17,50	TTD-4F05-1750-HP240	30597195
18,00	TTD-4F05-1800-HP240	30597200
18,20	TTD-4F05-1820-HP240	30597202
18,50	TTD-4F05-1850-HP240	30597205
18,60	TTD-4F05-1860-HP240	30597206
18,80	TTD-4F05-1880-HP240	30597208
19,00	TTD-4F05-1900-HP240	30597210
19,70	TTD-4F05-1970-HP240	30597217
20,50	TTD-4F05-2050-HP240	30597225
20,70	TTD-4F05-2070-HP240	30597227
20,80	TTD-4F05-2080-HP240	30597228

d ₁ from 21.00 to 37.00		
d ₁ m7	Specification	Order no.
21,00	TTD-4F05-2100-HP240	30597230
21,10	TTD-4F05-2110-HP240	30597231
21,50	TTD-4F05-2150-HP240	30597235
21,70	TTD-4F05-2170-HP240	30597237
22,00	TTD-4F05-2200-HP240	30597240
22,10	TTD-4F05-2210-HP240	30597241
22,30	TTD-4F05-2230-HP240	30597243
22,70	TTD-4F05-2270-HP240	30597247
23,00	TTD-4F05-2300-HP240	30597250
23,50	TTD-4F05-2350-HP240	30597255
24,00	TTD-4F05-2400-HP240	30597260
24,40	TTD-4F05-2440-HP240	30597264
24,80	TTD-4F05-2480-HP240	30597268
25,00	TTD-4F05-2500-HP240	30597270
25,80	TTD-4F05-2580-HP240	30597278
26,00	TTD-4F05-2600-HP240	30597280
27,00	TTD-4F05-2700-HP240	30597290
27,10	TTD-4F05-2710-HP240	30597291
28,00	TTD-4F05-2800-HP240	30597300
28,50	TTD-4F05-2850-HP240	30597305
30,00	TTD-4F05-3000-HP240	30597320
32,00	TTD-4F05-3200-HP240	30597341
37,00	TTD-4F05-3700-HP240	30597351

Configurable features



Diameter:
Diameter in increments of
0.01 mm freely selectable



Specification:

TTD-4F05-[diameter]-HP240

Dimensions of configurable series

d ₁ min.	d ₁ max.
12,00	45,00

Example:

TTD-4F05-1401-HP619

Tool diameter d₁ = 14.01 mm

Dimensions in mm.

For cutting data recommendations, see end of chapter.

Special designs and other coatings available upon request.

TTD replaceable drill head

Produced from solid carbide, internal coolant supply
Type 03 - Alu

Design:
 Drill diameter: 12.00 – 45.00 mm
 Bore tolerance: $\geq IT 9$
 Cutting material: HP685
 Number of cutting edges: 2
 Number of guiding chamfers: 4
 Tip angle: 140°

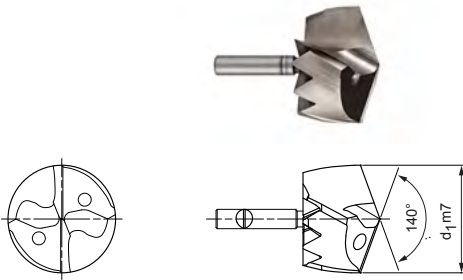

Stocked preferred series

d ₁ from 12.10 to 21.00		
d ₁ m7	Specification	Order no.
12,10	TTD-4F03-1210-HP685	30249057
12,50	TTD-4F03-1250-HP685	30231808
12,80	TTD-4F03-1280-HP685	30249062
13,00	TTD-4F03-1300-HP685	30231812
13,50	TTD-4F03-1350-HP685	30231815
14,00	TTD-4F03-1400-HP685	30231817
14,50	TTD-4F03-1450-HP685	30231818
14,70	TTD-4F03-1470-HP685	30231819
14,90	TTD-4F03-1490-HP685	30249077
15,00	TTD-4F03-1500-HP685	30231820
16,00	TTD-4F03-1600-HP685	30191460
16,10	TTD-4F03-1610-HP685	30249085
16,50	TTD-4F03-1650-HP685	30191461
17,00	TTD-4F03-1700-HP685	30191462
17,50	TTD-4F03-1750-HP685	30191463
18,00	TTD-4F03-1800-HP685	30191464
18,10	TTD-4F03-1810-HP685	30234210
18,20	TTD-4F03-1820-HP685	30249099
18,30	TTD-4F03-1830-HP685	30249100
18,50	TTD-4F03-1850-HP685	30191465
18,60	TTD-4F03-1860-HP685	30249102
18,70	TTD-4F03-1870-HP685	30219141
19,00	TTD-4F03-1900-HP685	30191466
19,50	TTD-4F03-1950-HP685	30191467
19,60	TTD-4F03-1960-HP685	30249109
20,00	TTD-4F03-2000-HP685	30191468
20,30	TTD-4F03-2030-HP685	30216431
20,50	TTD-4F03-2050-HP685	30191469
21,00	TTD-4F03-2100-HP685	30191470

d ₁ from 21.50 to 43.00		
d ₁ m7	Specification	Order no.
21,50	TTD-4F03-2150-HP685	30191471
22,00	TTD-4F03-2200-HP685	30191472
22,50	TTD-4F03-2250-HP685	30191473
22,60	TTD-4F03-2260-HP685	30249129
23,00	TTD-4F03-2300-HP685	30191474
23,50	TTD-4F03-2350-HP685	30191475
23,90	TTD-4F03-2390-HP685	30249138
24,00	TTD-4F03-2400-HP685	30191476
24,10	TTD-4F03-2410-HP685	30249139
24,40	TTD-4F03-2440-HP685	30249142
24,50	TTD-4F03-2450-HP685	30191477
25,00	TTD-4F03-2500-HP685	30191478
25,10	TTD-4F03-2510-HP685	30249146
25,20	TTD-4F03-2520-HP685	30249147
25,50	TTD-4F03-2550-HP685	30191479
26,00	TTD-4F03-2600-HP685	30191480
26,40	TTD-4F03-2640-HP685	30249156
27,00	TTD-4F03-2700-HP685	30191482
27,50	TTD-4F03-2750-HP685	30191483
28,00	TTD-4F03-2800-HP685	30191484
28,30	TTD-4F03-2830-HP685	30249169
28,40	TTD-4F03-2840-HP685	30249170
29,50	TTD-4F03-2950-HP685	30191487
31,00	TTD-4F03-3100-HP685	30191490
31,20	TTD-4F03-3120-HP685	30249189
32,00	TTD-4F03-3200-HP685	30191492
35,00	TTD-4F03-3500-HP685	30322405
43,00	TTD-4F03-4300-HP685	30322423

Configurable features



Diameter:
Diameter in increments of 0.01 mm freely selectable

Specification:
TTD-4F03-[diameter]-HP685

Dimensions of configurable series

d ₁ min.	d ₁ max.
12.00	45.00

Example:
TTD-4F03-1401-HP685

Tool diameter d₁ = 14.01 mm

Dimensions in mm.
 For cutting data recommendations, see end of chapter.
 Special designs and other coatings available upon request.

TTS replaceable head holder

With front clamping system for TTD replaceable head drill
TTS100, internal coolant supply

Design:

For drill diameter:

12.00 - 45.49 mm

Changing system:

Front clamping system
Head replacement on
the machine possible

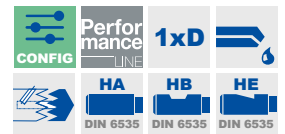
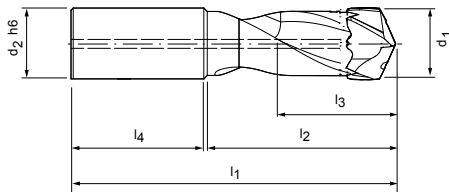

Stocked preferred series

Dimensions							Shank form HB	
d ₁	Connection	d ₂ h6	l ₁	l ₂	l ₃	l ₄	Specification	Order no.
12,00-12,49	TTS12-S	14	81	29	13	45	TTS100-12-DR1-1200-14-HB	30324304
12,50-12,99	TTS12-S	14	81	29	13	45	TTS100-12-DR1-1250-14-HB	30324305
13,00-13,49	TTS12-S	14	81	31	14	45	TTS100-12-DR1-1300-14-HB	30324306
13,50-13,99	TTS12-S	16	86	32	14	48	TTS100-12-DR1-1350-16-HB	30324307
14,00-14,49	TTS12-S	16	86	33	15	48	TTS100-12-DR1-1400-16-HB	30324308
14,50-14,99	TTS12-S	16	91	34	15	48	TTS100-12-DR1-1450-16-HB	30324309
15,00-15,49	TTS12-S	16	91	36	16	48	TTS100-12-DR1-1500-16-HB	30324310
15,50-16,49	TTS12-S	18	92	38	17	48	TTS100-12-DR1-1550-18-HB	30324311
16,50-17,49	TTS12-S	18	94	40	18	48	TTS100-12-DR1-1650-18-HB	30324312
17,50-18,49	TTS12-S	18	99	43	19	48	TTS100-12-DR1-1750-18-HB	30324313
18,50-19,49	TTS12-S	20	99	45	20	50	TTS100-12-DR1-1850-20-HB	30324314
19,50-20,49	TTS12-S	20	104	47	21	50	TTS100-12-DR1-1950-20-HB	30324316
20,50-21,49	TTS12-S	25	111	49	22	56	TTS100-12-DR1-2050-25-HB	30324317
21,50-22,49	TTS12-S	25	116	52	23	56	TTS100-12-DR1-2150-25-HB	30324318
22,50-23,49	TTS12-S	25	116	54	24	56	TTS100-12-DR1-2250-25-HB	30324319
23,50-24,49	TTS12-S	25	121	56	25	56	TTS100-12-DR1-2350-25-HB	30324320
24,50-25,49	TTS18-S	25	123	59	26	56	TTS100-18-DR1-2450-25-HB	30324321
25,50-26,49	TTS18-S	25	123	61	27	56	TTS100-18-DR1-2550-25-HB	30324322
26,50-27,49	TTS18-S	25	128	63	28	56	TTS100-18-DR1-2650-25-HB	30324323
27,50-28,49	TTS18-S	25	128	66	29	56	TTS100-18-DR1-2750-25-HB	30324325
28,50-29,49	TTS18-S	32	134	68	30	60	TTS100-18-DR1-2850-32-HB	30324327
29,50-30,49	TTS18-S	32	139	70	31	60	TTS100-18-DR1-2950-32-HB	30324328
30,50-31,49	TTS18-S	32	139	75	32	60	TTS100-18-DR1-3050-32-HB	30324329
31,50-32,49	TTS18-S	32	139	75	33	60	TTS100-18-DR1-3150-32-HB	30324330
32,50-33,49	TTS18-S	32	150	78	34	60	TTS100-18-DR1-3250-32-HB	30374587
33,50-34,49	TTS18-S	32	150	79	35	60	TTS100-18-DR1-3350-32-HB	30374590
35,50-37,49	TTS18-S	32	152	86	38	60	TTS100-18-DR1-3550-32-HB	30496703
34,50-35,49	TTS18-S	32	150	82	36	60	TTS100-18-DR1-3450-32-HB	30374593
35,50-37,49	TTS18-S	40	162	86	38	70	TTS100-18-DR1-3550-40-HB	30535302
37,50-39,49	TTS18-S	32	157	91	40	60	TTS100-18-DR1-3750-32-HB	30496704
37,50-39,49	TTS18-S	40	167	71	40	70	TTS100-18-DR1-3750-40-HB	30535303

Continued on next page.

TTS 100 replaceable head holder, internal coolant supply

Dimensions							Shank form HB	
d ₁	Connection	d ₂ h6	l ₁	l ₂	l ₃	l ₄	Specification	Order no.
39,50-41,49	TTS18-S	32	167	95	42	60	TTS100-18-DR1-3950-32-HB	30496705
39,50-41,49	TTS18-S	40	177	95	42	70	TTS100-18-DR1-3950-40-HB	30535305
41,50-43,49	TTS18-S	40	180	100	44	70	TTS100-18-DR1-4150-40-HB	30535307
43,50-45,49	TTS18-S	40	185	105	46	70	TTS100-18-DR1-4350-40-HB	30535312

Configurable features



Shank form:
Shank form: HA | HE



Specification:
TTS100-18-DR1-4150-40-[shank form]

Example:

TTS100-18-DR1-4150-40-HE

Shank form HE

TTS replaceable head holder

With front clamping system for TTD replaceable head drill
TTS100 (3xD), internal coolant supply

Design:

For drill diameter:

12.00 - 45.49 mm

Changing system:

Front clamping system
Head replacement on
the machine possible

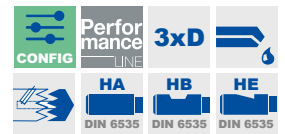
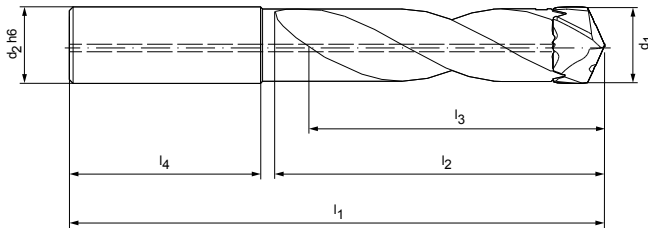

Stocked preferred series

Dimensions							Shank form HB	
d ₁	Connection	d ₂ h6	l ₁	l ₂	l ₃	l ₄	Specification	Order no.
12,00-12,49	TTS12-S	14	100	53	38	45	TTS100-12-DR3-1200-14-HB	30232785
12,50-12,99	TTS12-S	14	105	55	39	45	TTS100-12-DR3-1250-14-HB	30232787
13,00-13,49	TTS12-S	14	105	57	41	45	TTS100-12-DR3-1300-14-HB	30232789
13,50-13,99	TTS12-S	16	110	59	42	48	TTS100-12-DR3-1350-16-HB	30232790
14,00-14,49	TTS12-S	16	115	61	44	48	TTS100-12-DR3-1400-16-HB	30232792
14,50-14,99	TTS12-S	16	115	63	45	48	TTS100-12-DR3-1450-16-HB	30232793
15,00-15,49	TTS12-S	16	115	65	47	48	TTS100-12-DR3-1500-16-HB	30232794
15,50-16,49	TTS12-S	18	120	70	50	48	TTS100-12-DR3-1550-18-HB	30191496
16,50-17,49	TTS12-S	18	125	74	53	48	TTS100-12-DR3-1650-18-HB	30191497
17,50-18,49	TTS12-S	18	130	78	56	48	TTS100-12-DR3-1750-18-HB	30191498
18,50-19,49	TTS12-S	20	135	82	59	50	TTS100-12-DR3-1850-20-HB	30191499
19,50-20,49	TTS12-S	20	140	87	62	50	TTS100-12-DR3-1950-20-HB	30191500
20,50-21,49	TTS12-S	25	150	91	65	56	TTS100-12-DR3-2050-25-HB	30191501
21,50-22,49	TTS12-S	25	155	95	68	56	TTS100-12-DR3-2150-25-HB	30191502
22,50-23,49	TTS12-S	25	160	99	71	56	TTS100-12-DR3-2250-25-HB	30191503
23,50-24,49	TTS12-S	25	165	103	74	56	TTS100-12-DR3-2350-25-HB	30191504
24,50-25,49	TTS18-S	25	165	108	77	56	TTS100-18-DR3-2450-25-HB	30191505
25,50-26,49	TTS18-S	25	175	112	80	56	TTS100-18-DR3-2550-25-HB	30191507
26,50-27,49	TTS18-S	25	175	116	83	56	TTS100-18-DR3-2650-25-HB	30191508
27,50-28,49	TTS18-S	25	180	120	86	56	TTS100-18-DR3-2750-25-HB	30191509
28,50-29,49	TTS18-S	32	190	124	89	60	TTS100-18-DR3-2850-32-HB	30191510
29,50-30,49	TTS18-S	32	195	129	92	60	TTS100-18-DR3-2950-32-HB	30191511
30,50-31,49	TTS18-S	32	195	133	95	60	TTS100-18-DR3-3050-32-HB	30191512
31,50-32,49	TTS18-S	32	200	137	98	60	TTS100-18-DR3-3150-32-HB	30191513
32,50-33,49	TTS18-S	32	210	144	101	60	TTS100-18-DR3-3250-32-HB	30322289
33,50-34,49	TTS18-S	32	215	148	104	60	TTS100-18-DR3-3350-32-HB	30322290
34,50-35,49	TTS18-S	32	227	161	107	60	TTS100-18-DR3-3550-32-HB	30496706
34,50-35,49	TTS18-S	32	220	153	107	60	TTS100-18-DR3-3450-32-HB	30322291
35,50-37,49	TTS18-S	40	237	161	113	70	TTS100-18-DR3-3550-40-HB	30535313
37,50-39,49	TTS18-S	32	237	170	119	60	TTS100-18-DR3-3750-32-HB	30496707
37,50-39,49	TTS18-S	40	247	170	119	70	TTS100-18-DR3-3750-40-HB	30535316
39,50-41,49	TTS18-S	32	247	178	125	60	TTS100-18-DR3-3950-32-HB	30496708

Continued on next page.

TTS 100 (3xD) replaceable head holder, internal coolant supply

Dimensions							Shank form HB	
d ₁	Connection	d ₂ h6	l ₁	l ₂	l ₃	l ₄	Specification	Order no.
39,50-41,49	TTS18-S	40	257	178	125	70	TTS100-18-DR3-3950-40-HB	30535318
41,50-43,49	TTS18-S	40	265	187	131	70	TTS100-18-DR3-4150-40-HB	30535320
43,50-45,49	TTS18-S	40	275	196	137	70	TTS100-18-DR3-4350-40-HB	30535321

Configurable features



Shank form:
Shank form: HA | HE



Specification:
TTS100-18-DR5-4150-40-[shank form]

Example:

TTS100-18-DR5-4150-40-HE

Shank form HE

TTS replaceable head holder

With front clamping system for TTD replaceable head drill
TTS100 (5xD), internal coolant supply

Design:

For drill diameter:

12.00 - 45.49 mm

Changing system:

Front clamping system
Head replacement on
the machine possible

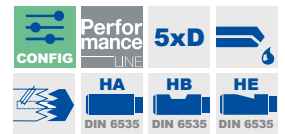
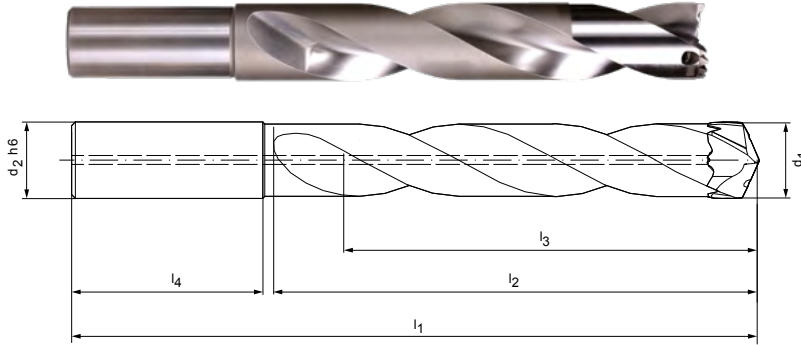

Stocked preferred series

Dimensions							Shank form HB	
d ₁	Connection	d ₂ h6	l ₁	l ₂	l ₃	l ₄	Specification	Order no.
12,00-12,49	TTS12-S	14	125	78	63	45	TTS100-12-DR5-1200-14-HB	30232796
12,50-12,99	TTS12-S	14	130	81	65	45	TTS100-12-DR5-1250-14-HB	30232798
13,00-13,49	TTS12-S	14	130	84	68	45	TTS100-12-DR5-1300-14-HB	30232799
13,50-13,99	TTS12-S	16	140	88	70	48	TTS100-12-DR5-1350-16-HB	30232800
14,00-14,49	TTS12-S	16	140	90	73	48	TTS100-12-DR5-1400-16-HB	30232801
14,50-14,99	TTS12-S	16	145	94	75	48	TTS100-12-DR5-1450-16-HB	30232802
15,00-15,49	TTS12-S	16	145	96	78	48	TTS100-12-DR5-1500-16-HB	30232803
15,50-16,49	TTS12-S	18	155	103	83	48	TTS100-12-DR5-1550-18-HB	30191514
16,50-17,49	TTS12-S	18	160	109	88	48	TTS100-12-DR5-1650-18-HB	30191515
17,50-18,49	TTS12-S	18	165	115	93	48	TTS100-12-DR5-1750-18-HB	30191516
18,50-19,49	TTS12-S	20	175	121	98	50	TTS100-12-DR5-1850-20-HB	30191517
19,50-20,49	TTS12-S	20	180	128	103	50	TTS100-12-DR5-1950-20-HB	30191518
20,50-21,49	TTS12-S	25	195	134	108	56	TTS100-12-DR5-2050-25-HB	30191519
21,50-22,49	TTS12-S	25	200	140	113	56	TTS100-12-DR5-2150-25-HB	30191520
22,50-23,49	TTS12-S	25	205	146	118	56	TTS100-12-DR5-2250-25-HB	30191521
23,50-24,49	TTS12-S	25	210	152	123	56	TTS100-12-DR5-2350-25-HB	30191522
24,50-25,49	TTS18-S	25	220	159	128	56	TTS100-18-DR5-2450-25-HB	30191523
25,50-26,49	TTS18-S	25	225	165	133	56	TTS100-18-DR5-2550-25-HB	30191525
26,50-27,49	TTS18-S	25	230	171	138	56	TTS100-18-DR5-2650-25-HB	30191526
27,50-28,49	TTS18-S	25	240	177	143	56	TTS100-18-DR5-2750-25-HB	30191527
28,50-29,49	TTS18-S	32	250	183	148	60	TTS100-18-DR5-2850-32-HB	30191528
29,50-30,49	TTS18-S	32	255	190	153	60	TTS100-18-DR5-2950-32-HB	30191529
30,50-31,49	TTS18-S	32	260	196	158	60	TTS100-18-DR5-3050-32-HB	30191530
31,50-32,49	TTS18-S	32	265	202	163	60	TTS100-18-DR5-3150-32-HB	30191531
32,50-33,49	TTS18-S	32	275	210	168	60	TTS100-18-DR5-3250-32-HB	30322313
33,50-34,49	TTS18-S	32	285	217	173	60	TTS100-18-DR5-3350-32-HB	30322314
34,50-35,49	TTS18-S	32	290	224	178	60	TTS100-18-DR5-3450-32-HB	30322315
35,50-37,49	TTS18-S	32	302	236	188	60	TTS100-18-DR5-3550-32-HB	30496709
*35,50-37,49	TTS18-S	40	312	236	188	70	TTS100-18-DR5-3550-40-HB	30535324
37,50-39,49	TTS18-S	32	317	249	198	60	TTS100-18-DR5-3750-32-HB	30496710
*37,50-39,49	TTS18-S	40	327	249	198	70	TTS100-18-DR5-3750-40-HB	30534860

Continued on next page.

TTS 100 (5xD) replaceable head holder, internal coolant supply

Dimensions							Shank form HB	
d ₁	Connection	d ₂ h6	l ₁	l ₂	l ₃	l ₄	Specification	Order no.
39,50-41,49	TTS18-S	32	327	261	208	60	TTS100-18-DR5-3950-32-HB	30496711
*39,50-41,49	TTS18-S	40	337	261	208	70	TTS100-18-DR5-3950-40-HB	30535326
*41,50-43,49	TTS18-S	40	350	274	218	70	TTS100-18-DR5-4150-40-HB	30535327
*43,50-45,49	TTS18-S	40	365	287	228	70	TTS100-18-DR5-4350-40-HB	30535328

Configurable features



Shank form:
Shank form: HA | HE



Specification:
TTS100-18-DR5-4150-40-[shank form]

Example:

TTS100-18-DR5-4150-40-HE

Shank form HE

TTS replaceable head holder

With front clamping system for TTD replaceable head drill
TTS100 (8xD), internal coolant supply

Design:

For drill diameter:

12.00 - 45.49 mm

Changing system:

Front clamping system
Head replacement on
the machine possible

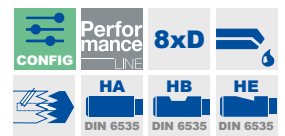
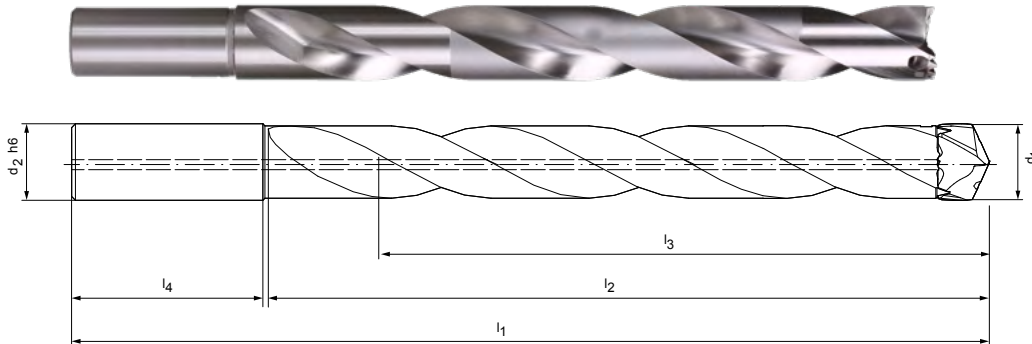

Stocked preferred series

Dimensions							Shank form HB	
d ₁	Connection	d ₂ h6	l ₁	l ₂	l ₃	l ₄	Specification	Order no.
12,00-12,49	TTS12-S	14	165	116	100	45	TTS100-12-DR8-1200-14-HB	30232805
12,50-12,99	TTS12-S	14	170	121	104	45	TTS100-12-DR8-1250-14-HB	30232806
13,00-13,49	TTS12-S	14	175	126	108	45	TTS100-12-DR8-1300-14-HB	30232807
13,50-13,99	TTS12-S	16	180	129	112	48	TTS100-12-DR8-1350-16-HB	30232808
14,00-14,49	TTS12-S	16	185	134	116	48	TTS100-12-DR8-1400-16-HB	30232809
14,50-14,99	TTS12-S	16	190	139	120	48	TTS100-12-DR8-1450-16-HB	30232810
15,00-15,49	TTS12-S	16	195	144	124	48	TTS100-12-DR8-1500-16-HB	30232811
15,50-16,49	TTS12-S	18	205	152	132	48	TTS100-12-DR8-1550-18-HB	30191532
16,50-17,49	TTS12-S	18	215	161	140	48	TTS100-12-DR8-1650-18-HB	30191533
17,50-18,49	TTS12-S	18	220	171	148	48	TTS100-12-DR8-1750-18-HB	30191534
18,50-19,49	TTS12-S	20	235	180	156	50	TTS100-12-DR8-1850-20-HB	30191535
19,50-20,49	TTS12-S	20	240	189	164	50	TTS100-12-DR8-1950-20-HB	30191536
20,50-21,49	TTS12-S	25	260	198	172	56	TTS100-12-DR8-2050-25-HB	30191537
21,50-22,49	TTS12-S	25	270	207	180	56	TTS100-12-DR8-2150-25-HB	30191538
22,50-23,49	TTS12-S	25	275	217	188	56	TTS100-12-DR8-2250-25-HB	30191539
23,50-24,49	TTS12-S	25	285	226	196	56	TTS100-12-DR8-2350-25-HB	30191540
24,50-25,49	TTS18-S	25	295	235	204	56	TTS100-18-DR8-2450-25-HB	30191541
25,50-26,49	TTS18-S	25	305	244	212	56	TTS100-18-DR8-2550-25-HB	30191543
26,50-27,49	TTS18-S	25	315	253	220	56	TTS100-18-DR8-2650-25-HB	30191544
27,50-28,49	TTS18-S	25	325	263	228	56	TTS100-18-DR8-2750-25-HB	30191545
28,50-29,49	TTS18-S	32	340	272	236	60	TTS100-18-DR8-2850-32-HB	30191546
29,50-30,49	TTS18-S	32	345	281	244	60	TTS100-18-DR8-2950-32-HB	30191547
30,50-31,49	TTS18-S	32	355	290	252	60	TTS100-18-DR8-3050-32-HB	30191548
31,50-32,49	TTS18-S	32	360	299	260	60	TTS100-18-DR8-3150-32-HB	30191549
32,50 - 33,49	TTS18-S	32	375	275	268	60	TTS100-18-DR8-3250-32-HB	30809129
33,50 - 34,49	TTS18-S	32	385	317	276	60	TTS100-18-DR8-3350-32-HB	30809654
34,50 - 35,49	TTS18-S	32	395	329	284	60	TTS100-18-DR8-3450-32-HB	30809664
35,50 - 37,49	TTS18-S	32	402	336	300	60	TTS100-18-DR8-3550-32-HB	30812380
35,50 - 37,49	TTS18-S	40	412	336	300	70	TTS100-18-DR8-3550-40-HB	30809673

Continued on next page.

TTS 100 (8xD) replaceable head holder, internal coolant supply

Dimensions							Shank form HB	
d ₁	Connection	d ₂ h6	l ₁	l ₂	l ₃	l ₄	Specification	Order no.
37,50 - 39,49	TTS18-S	32	421	353	316	60	TTS100-18-DR8-3750-32-HB	30812379
37,50 - 39,49	TTS18-S	40	431	353	316	70	TTS100-18-DR8-3750-40-HB	30809961
39,50 - 41,49	TTS18-S	32	440	374	332	70	TTS100-18-DR8-3950-32-HB	30812376
39,50 - 41,49	TTS18-S	40	450	374	332	70	TTS100-18-DR8-3950-40-HB	30809964
41,50 - 43,49	TTS18-S	40	470	394	348	70	TTS100-18-DR8-4150-40-HB	30809976
43,50 - 45,49	TTS18-S	40	500	422	364	70	TTS100-18-DR8-4350-40-HB	30809158

Configurable features



Shank form:
Shank form: HA | HE



Specification:
TTS100-18-DR8-4150-40-[shank form]

Example:

TTS100-18-DR8-4150-40-HE

Shank form HE

TTS replaceable head holder

With front clamping system for TTD replaceable head drill
TTS100 (12xD), internal coolant supply

Design:

For drill diameter:

12.00 - 32.49 mm

Changing system:

Front clamping system
Head replacement on
the machine possible

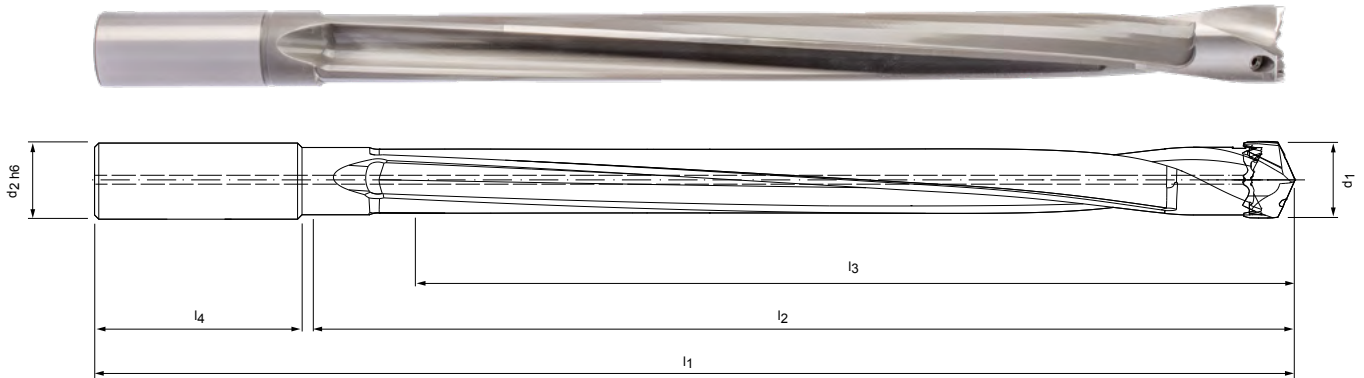

Stocked preferred series

Dimensions							Shank form HB	
d ₁	Connection	d ₂ h6	l ₁	l ₂	l ₃	l ₄	Specification	Order no.
12,00-12,49	TTS12-S	14	210	162	150	45	TTS100-12-DR12-1200-14-HB	30327798
12,50-12,99	TTS12-S	14	216	168	156	45	TTS100-12-DR12-1250-14-HB	30327802
13,00-13,49	TTS12-S	14	223	175	162	45	TTS100-12-DR12-1300-14-HB	30327805
13,50-13,99	TTS12-S	16	235	182	168	48	TTS100-12-DR12-1350-16-HB	30327808
14,00-14,49	TTS12-S	16	242	189	174	48	TTS100-12-DR12-1400-16-HB	30327811
14,50-14,99	TTS12-S	16	248	195	180	48	TTS100-12-DR12-1450-16-HB	30327814
15,00-15,49	TTS12-S	16	255	202	186	48	TTS100-12-DR12-1500-16-HB	30327817
15,50-16,49	TTS12-S	18	262	209	198	48	TTS100-12-DR12-1550-18-HB	30327820
16,50-17,49	TTS12-S	18	275	222	210	48	TTS100-12-DR12-1650-18-HB	30327824
17,50-18,49	TTS12-S	18	289	236	222	48	TTS100-12-DR12-1750-18-HB	30327828
18,50-19,49	TTS12-S	20	304	249	234	50	TTS100-12-DR12-1850-20-HB	30327833
19,50-20,49	TTS12-S	20	318	263	246	50	TTS100-12-DR12-1950-20-HB	30255588
20,50-21,49	TTS12-S	25	337	276	258	56	TTS100-12-DR12-2050-25-HB	30327844
21,50-22,49	TTS12-S	25	351	290	270	56	TTS100-12-DR12-2150-25-HB	30327847
22,50-23,49	TTS12-S	25	364	303	282	56	TTS100-12-DR12-2250-25-HB	30327851
23,50-24,49	TTS12-S	25	378	317	294	56	TTS100-12-DR12-2350-25-HB	30327854
24,50-25,49	TTS18-S	25	391	330	306	56	TTS100-18-DR12-2450-25-HB	30327859
25,50-26,49	TTS18-S	25	405	344	318	56	TTS100-18-DR12-2550-25-HB	30327863
26,50-27,49	TTS18-S	25	418	357	330	56	TTS100-18-DR12-2650-25-HB	30327866
27,50-28,49	TTS18-S	25	432	371	342	56	TTS100-18-DR12-2750-25-HB	30327870
28,50-29,49	TTS18-S	32	449	384	354	60	TTS100-18-DR12-2850-32-HB	30327873
29,50-30,49	TTS18-S	32	463	398	366	60	TTS100-18-DR12-2950-32-HB	30327876
30,50-31,49	TTS18-S	32	476	411	378	60	TTS100-18-DR12-3050-32-HB	30327879
31,50-32,49	TTS18-S	32	490	425	390	60	TTS100-18-DR12-3150-32-HB	30327883

Configurable features



Shank form:
Shank form: HA | HE



Specification:

TTS100-18-DR12-2850-32-[shank form]

Example:

TTS100-18-DR12-2850-32-HE

Shank form HE

Dimensions in mm.

Pay attention to the handling notes for the TTD (12xD) replaceable head drill on page 748. Special designs available upon request.

Spare parts

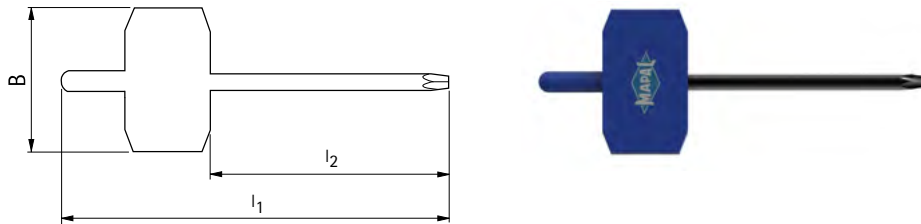

Hexagonal wrench

Tool holder type	sw	l_1	l_2	B	Order no.
TS100-12-DRx-1200-14-HB	1,3	95	60	38	10004355
TS100-12-DRx-1250-14-HB	1,3	95	60	38	10004355
TS100-12-DRx-1300-14-HB	1,3	95	60	38	10004355
TS100-12-DRx-1350-16-HB	1,5	95	60	38	10098108
TS100-12-DRx-1400-16-HB	1,5	95	60	38	10098108
TS100-12-DRx-1450-16-HB	1,5	95	60	38	10098108
TS100-12-DRx-1500-16-HB	1,5	95	60	38	10098108
TS100-12-DRx-1550-18-HB	1,5	95	60	38	10098108
TS100-12-DRx-1650-18-HB	2	95	60	38	10098109
TS100-12-DRx-1750-18-HB	2	95	60	38	10098109
TS100-12-DRx-1850-20-HB	2	95	60	38	10098109
TS100-12-DRx-1950-20-HB	2	95	60	38	10098109
TS100-12-DRx-2050-25-HB	2	95	60	38	10098109
TS100-12-DRx-2150-25-HB	2	95	60	38	10098109
TS100-12-DRx-2250-25-HB	2	95	60	38	10098109
TS100-12-DRx-2350-25-HB	2	95	60	38	10098109
TS100-18-DRx-2450-25-HB	2,5	95	60	38	10098110
TS100-18-DRx-2550-25-HB	2,5	95	60	38	10098110
TS100-18-DRx-2650-25-HB	2,5	95	60	38	10098110
TS100-18-DRx-2750-25-HB	2,5	95	60	38	10098110
TS100-18-DRx-2850-32-HB	2,5	95	60	38	10098110
TS100-18-DRx-2950-32-HB	2,5	95	60	38	10098110
TS100-18-DRx-3050-32-HB	2,5	95	60	38	10098110
TS100-18-DRx-3150-32-HB	2,5	95	60	38	10098110
TS100-18-DRx-3250-32-HB	3	100	60	38	10006234
TS100-18-DRx-3350-32-HB	3	100	60	38	10006234
TS100-18-DRx-3450-32-HB	3	100	60	38	10006234
TS100-18-DRx-3550-40-HB	3	100	60	38	10006234
TS100-18-DRx-3750-40-HB	3	100	60	38	10006234
TS100-18-DRx-3950-40-HB	3	100	60	38	10006234
TS100-18-DRx-4150-40-HB	4	100	60	38	10006235
TS100-18-DRx-4350-40-HB	4	100	60	38	10006235

Threaded pin with special coating

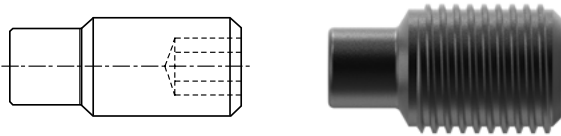

Tool holder type	Threaded pin	Tightening torque [Nm]	Order no.
TS100-12-DRx-1200-14-HB	M2,5x5	1,0	30259117
TS100-12-DRx-1250-14-HB	M2,5x6	1,0	30259118
TS100-12-DRx-1300-14-HB	M2,5x6	1,0	30259118
TS100-12-DRx-1350-16-HB	M3x6	1,3	30259119
TS100-12-DRx-1400-16-HB	M3x6	1,3	30259119
TS100-12-DRx-1450-16-HB	M3x7	1,3	30193231
TS100-12-DRx-1500-16-HB	M3x7	1,3	30193231
TS100-12-DRx-1550-18-HB	M3x7	1,3	30193231
TS100-12-DRx-1650-18-HB	M4x0,5x7,5	3,5	30193232
TS100-12-DRx-1750-18-HB	M4x0,5x7,5	3,5	30193232
TS100-12-DRx-1850-20-HB	M4x0,5x7,5	3,5	30193232
TS100-12-DRx-1950-20-HB	M4x0,5x7,5	3,5	30193232
TS100-12-DRx-2050-25-HB	M4x0,5x10	3,5	30193233
TS100-12-DRx-2150-25-HB	M4x0,5x10	3,5	30193233
TS100-12-DRx-2250-25-HB	M4x0,5x10	3,5	30193233
TS100-12-DRx-2350-25-HB	M4x0,5x10	3,5	30193233
TS100-18-DRx-2450-25-HB	M5x0,5x11	4,0	30193234
TS100-18-DRx-2550-25-HB	M5x0,5x11	4,0	30193234
TS100-18-DRx-2650-25-HB	M5x0,5x11	4,0	30193234
TS100-18-DRx-2750-25-HB	M5x0,5x11	4,0	30193234
TS100-18-DRx-2850-32-HB	M5x0,5x14	4,0	30193235
TS100-18-DRx-2950-32-HB	M5x0,5x14	4,0	30193235
TS100-18-DRx-3050-32-HB	M5x0,5x14	4,0	30193235
TS100-18-DRx-3150-32-HB	M5x0,5x14	4,0	30193235
TS100-18-DRx-3250-32-HB	M6x0,5x16	6,0	30320812
TS100-18-DRx-3350-32-HB	M6x0,5x16	6,0	30320812
TS100-18-DRx-3450-32-HB	M6x0,5x16	6,0	30320812
TS100-18-DRx-3550-40-HB	M6x0,5x18	6,0	30320811
TS100-18-DRx-3750-40-HB	M6x0,5x18	6,0	30320811
TS100-18-DRx-3950-40-HB	M6x0,5x20	6,0	30320810
TS100-18-DRx-4150-40-HB	M8x1x20	10,0	30320806
TS100-18-DRx-4350-40-HB	M8x1x20	10,0	30320806

Cutting data recommendation for TTD replaceable head drills

Feed and cutting speed

Type 01 – Uni-Plus

MMG*	Workpiece material		Strength/hardness [N/mm ²] [HRC]
P	P1	P1.1 Structural, free-cutting, case hardened and heat-treated steels, non-alloy	< 700
		P1.2 Structural, free-cutting, case hardened and heat-treated steels, non-alloy	< 1,200
	P2	P2.1 Nitrided, case hardened and heat-treated steels, alloy	< 900
		P2.2 Nitrided, case hardened and heat-treated steels, alloy	< 1,400
	P3	P3.1 Tool, bearing, spring and high-speed steels**	< 800
		P3.2 Tool, bearing, spring and high-speed steels**	< 1,000
		P3.3 Tool, bearing, spring and high-speed steels**	< 1,500
P5	P5.1 Cast steel		
K	K1	K1.1 Cast iron with lamellar graphite (grey cast iron), GJL	< 300
		K2.1 Cast iron with spheroidal graphite, GJS	< 500
	K2	K2.2 Cast iron with spheroidal graphite, GJS	≤ 800
		K2.3 Cast iron with spheroidal graphite, GJS	> 800
	K3	K3.1 Cast iron with spheroidal graphite, GJV; malleable cast iron, GJM	< 500
		K3.2 Cast iron with spheroidal graphite, GJV; malleable cast iron, GJM	> 500

Type 04 – Steel

MMG*	Workpiece material		Strength/hardness [N/mm ²] [HRC]
P	P1	P1.1 Structural, free-cutting, case hardened and heat-treated steels, non-alloy	< 700
		P1.2 Structural, free-cutting, case hardened and heat-treated steels, non-alloy	< 1,200
	P2	P2.1 Nitrided, case hardened and heat-treated steels, alloy	< 900
		P2.2 Nitrided, case hardened and heat-treated steels, alloy	< 1,400
	P3	P3.1 Tool, bearing, spring and high-speed steels**	< 800
		P3.2 Tool, bearing, spring and high-speed steels**	< 1,000
		P3.3 Tool, bearing, spring and high-speed steels**	< 1,500
P4	P4.1 Stainless steels, ferritic and martensitic		
P5	P5.1 Cast steel		
P6	P6.1 Stainless cast steel, ferritic and martensitic		
K	K1	K1.1 Cast iron with lamellar graphite (grey cast iron), GJL	< 300
		K2.1 Cast iron with spheroidal graphite, GJS	< 500
	K2	K2.2 Cast iron with spheroidal graphite, GJS	≤ 800
		K2.3 Cast iron with spheroidal graphite, GJS	> 800
	K3	K3.1 Cast iron with spheroidal graphite, GJV; malleable cast iron, GJM	< 500
		K3.2 Cast iron with spheroidal graphite, GJV; malleable cast iron, GJM	> 500

Type 03 – Alu

MMG*	Workpiece material		Strength/hardness [N/mm ²] [HRC]
N	N1	N1.1 Aluminium, non-alloy and alloy < 3 % Si	
		N1.2 Aluminium, alloy ≤ 7 % Si	
		N1.3 Aluminium, alloy > 7-12 % Si	
		N1.4 Aluminium, alloy > 12 % Si	
	N2	N2.1 Copper, non-alloy and low-alloy	< 300
		N2.2 Copper, alloy	> 300
		N2.3 Brass, bronze, gunmetal	< 1,200

* MAPAL machining groups

** If the alloy parts Cr, Mo, Ni, V, W in total > 8% then select the next highest MAPAL machining group.

	Cutting speed v_c [m/min]				Feed f [mm] for drill diameter					
	Internal cooling	External cooling	MQL	Air	12.00	15.50	19.50	25.00	32.00	40.00
	110	100	100		0.23	0.26	0.29	0.32	0.33	0.33
	100	85	85		0.29	0.33	0.37	0.40	0.41	0.41
	110	95	95		0.27	0.31	0.35	0.37	0.39	0.39
	75	65	65		0.22	0.25	0.27	0.30	0.31	0.31
	85	70	70		0.24	0.28	0.31	0.34	0.35	0.35
	65	60	60		0.20	0.23	0.25	0.27	0.28	0.29
	65	50	55		0.16	0.18	0.20	0.21	0.22	0.22
	110	95	95		0.27	0.31	0.35	0.37	0.39	0.39
	110	75	75	75	0.34	0.39	0.44	0.48	0.49	0.49
	145	90	110	110	0.31	0.36	0.40	0.44	0.45	0.46
	90	70	70		0.27	0.31	0.35	0.38	0.39	0.39
	55	35	45		0.18	0.21	0.23	0.25	0.26	0.26
	80	70	70		0.29	0.34	0.37	0.40	0.42	0.42
	70	65	65		0.23	0.27	0.30	0.32	0.33	0.33

	Cutting speed v_c [m/min]				Feed f [mm] for drill diameter					
	Internal cooling	External cooling	MQL	Air	12.00	15.50	19.50	25.00	32.00	40.00
	110	100	100		0.26	0.30	0.34	0.36	0.38	0.38
	100	85	85		0.33	0.38	0.42	0.46	0.47	0.47
	110	95	95		0.31	0.36	0.40	0.43	0.45	0.45
	75	65	65		0.25	0.28	0.31	0.34	0.35	0.35
	85	70	70		0.28	0.32	0.36	0.39	0.40	0.41
	65	60	60		0.23	0.26	0.29	0.32	0.33	0.33
	65	50	55		0.18	0.20	0.23	0.24	0.25	0.25
	65	50	55		0.18	0.21	0.24	0.25	0.26	0.27
	110	95	95		0.31	0.36	0.40	0.43	0.45	0.45
	110	75	75	75	0.37	0.44	0.49	0.53	0.55	0.55
	145	90	110	110	0.35	0.40	0.45	0.49	0.50	0.51
	90	70	70		0.30	0.35	0.39	0.42	0.43	0.43
	55	35	45		0.20	0.23	0.25	0.27	0.28	0.29
	80	70	70		0.32	0.37	0.41	0.45	0.47	0.47
	70	65	65		0.26	0.30	0.33	0.35	0.37	0.37

	Cutting speed v_c [m/min]				Feed f [mm] for drill diameter					
	Internal cooling	External cooling	MQL	Air	12.00	15.50	19.50	25.00	32.00	40.00
	300	200	250		0.23	0.26	0.29	0.32	0.33	0.33
	250	180	200		0.30	0.35	0.39	0.42	0.43	0.43
	220	150	180		0.30	0.35	0.39	0.42	0.43	0.43
	180	120	150		0.30	0.35	0.39	0.42	0.43	0.43
	140	100			0.23	0.26	0.29	0.32	0.33	0.33
	120	90			0.30	0.35	0.39	0.42	0.43	0.43
	200	160	160	120	0.37	0.44	0.49	0.53	0.55	0.55

The specified cutting values are guide values.

The optimum data for the respective machining task should be determined during the test or machining.

Cutting data recommendation for TTD replaceable head drills

Feed and cutting speed

Type 02 – Inox

MMG*	Workpiece material	Strength/hardness [N/mm ²] [HRC]
P	P1.1 Structural, free-cutting, case hardened and heat-treated steels, non-alloy	< 700
	P1.2 Structural, free-cutting, case hardened and heat-treated steels, non-alloy	< 1,200
	P2.1 Nitrided, case hardened and heat-treated steels, alloy	< 900
	P2.2 Nitrided, case hardened and heat-treated steels, alloy	< 1,400
	P3.1 Tool, bearing, spring and high-speed steels**	< 800
	P3.2 Tool, bearing, spring and high-speed steels**	< 1,000
	P3.3 Tool, bearing, spring and high-speed steels**	< 1,500
	P4.1 Stainless steels, ferritic and martensitic	
	P5.1 Cast steel	
P6.1 Stainless cast steel, ferritic and martensitic		
M	M1.1 Stainless steels, austenitic	< 700
	M1.2 Stainless steels, ferritic/austenitic (duplex)	< 1,000
	M2.1 Stainless/heat-resistant cast steel, austenitic	< 700
	M3.1 Stainless cast steel, ferritic/austenitic (duplex)	< 1,000
K	K1.1 Cast iron with lamellar graphite (grey cast iron), GJL	< 300
	K2.1 Cast iron with spheroidal graphite, GJS	< 500
	K2.2 Cast iron with spheroidal graphite, GJS	≤ 800
	K2.3 Cast iron with spheroidal graphite, GJS	> 800
	K3.1 Cast iron with spheroidal graphite, GJV; malleable cast iron, GJM	< 500
	K3.2 Cast iron with spheroidal graphite, GJV; malleable cast iron, GJM	> 500
N2	N2.1 Copper, non-alloy and low-alloy	< 300
	N2.2 Copper, alloy	> 300
	N2.3 Brass, bronze, gunmetal	< 1,200
S	S1.1 Titanium, titanium alloys	< 400
	S2.1 Titanium, titanium alloys	< 1,200
	S2.2 Titanium, titanium alloys	> 1,200
	S3.1 Nickel, unalloyed and alloyed	< 900
	S3.2 Nickel, unalloyed and alloyed	> 900
	S4.1 High-temperature super alloy Ni, Co and Fe-based	
	S5.1 Tungsten and molybdenum alloys	

Type 05 – Iron

MMG*	Workpiece material	Strength/hardness [N/mm ²] [HRC]
K	K1.1 Cast iron with lamellar graphite (grey cast iron), GJL	< 300
	K2.1 Cast iron with spheroidal graphite, GJS	< 500
	K2.2 Cast iron with spheroidal graphite, GJS	≤ 800
	K2.3 Cast iron with spheroidal graphite, GJS	> 800
	K3.1 Cast iron with spheroidal graphite, GJV; malleable cast iron, GJM	< 500
	K3.2 Cast iron with spheroidal graphite, GJV; malleable cast iron, GJM	> 500

* MAPAL machining groups

** If the alloy parts Cr, Mo, Ni, V, W in total > 8% then select the next highest MAPAL machining group.

	Cutting speed v_c [m/min]				Feed f [mm] for drill diameter					
	Internal cooling	External cooling	MQL	Air	12.00	15.50	19.50	25.00	32.00	40.00
	100	90	90		0.21	0.24	0.26	0.28	0.30	0.30
	90	75	75		0.26	0.30	0.33	0.36	0.37	0.37
	100	85	85		0.24	0.28	0.31	0.34	0.35	0.35
	70	60	60		0.19	0.22	0.25	0.27	0.28	0.28
	75	65	65		0.22	0.25	0.28	0.30	0.32	0.32
	60	55	55		0.18	0.21	0.23	0.25	0.26	0.26
	60	45	50		0.14	0.16	0.18	0.19	0.20	0.20
	60	45	50		0.14	0.17	0.18	0.20	0.21	0.21
	100	85	85		0.24	0.28	0.31	0.34	0.35	0.35
	60	45	50		0.14	0.17	0.18	0.20	0.21	0.21
	55	35	35		0.18	0.21	0.24	0.25	0.26	0.27
	50	30	30		0.16	0.18	0.20	0.22	0.23	0.23
	55	35	35		0.18	0.21	0.24	0.25	0.26	0.27
	50	30	30		0.16	0.18	0.20	0.22	0.23	0.23
	95	70	70	70	0.34	0.39	0.44	0.48	0.49	0.49
	130	80	95	95	0.31	0.36	0.40	0.44	0.45	0.46
	80	60	60		0.27	0.31	0.35	0.38	0.39	0.39
	50	30	40		0.18	0.21	0.23	0.25	0.26	0.26
	70	65	65		0.29	0.34	0.37	0.40	0.42	0.42
	65	55	55		0.23	0.27	0.30	0.32	0.33	0.33
	140	100			0.23	0.26	0.29	0.32	0.33	0.33
	120	90			0.30	0.35	0.39	0.42	0.43	0.43
	200	160	160	120	0.37	0.44	0.49	0.53	0.55	0.55
	40	25			0.16	0.18	0.21	0.22	0.23	0.23
	30	20			0.14	0.16	0.18	0.19	0.20	0.20
	25	15			0.11	0.13	0.15	0.16	0.16	0.17
	20	15			0.09	0.11	0.12	0.13	0.13	0.13
	15	10			0.11	0.13	0.15	0.16	0.16	0.17
	15	10			0.09	0.11	0.12	0.13	0.13	0.13
	15	10			0.09	0.11	0.12	0.13	0.13	0.13

	Cutting speed v_c [m/min]				Feed f [mm] for drill diameter					
	Internal cooling	External cooling	MQL	Air	12.00	15.50	19.50	25.00	32.00	40.00
	120	85	85	85	0.45	0.52	0.58	0.63	0.66	0.66
	160	100	120	120	0.42	0.48	0.54	0.58	0.60	0.61
	100	75	75		0.36	0.42	0.46	0.50	0.52	0.52
	60	40	50		0.24	0.28	0.30	0.33	0.34	0.34
	90	80	80		0.39	0.45	0.50	0.54	0.56	0.56
	80	70	70		0.31	0.36	0.39	0.43	0.44	0.44

The specified cutting values are guide values.

The optimum data for the respective machining task should be determined during the test or machining.

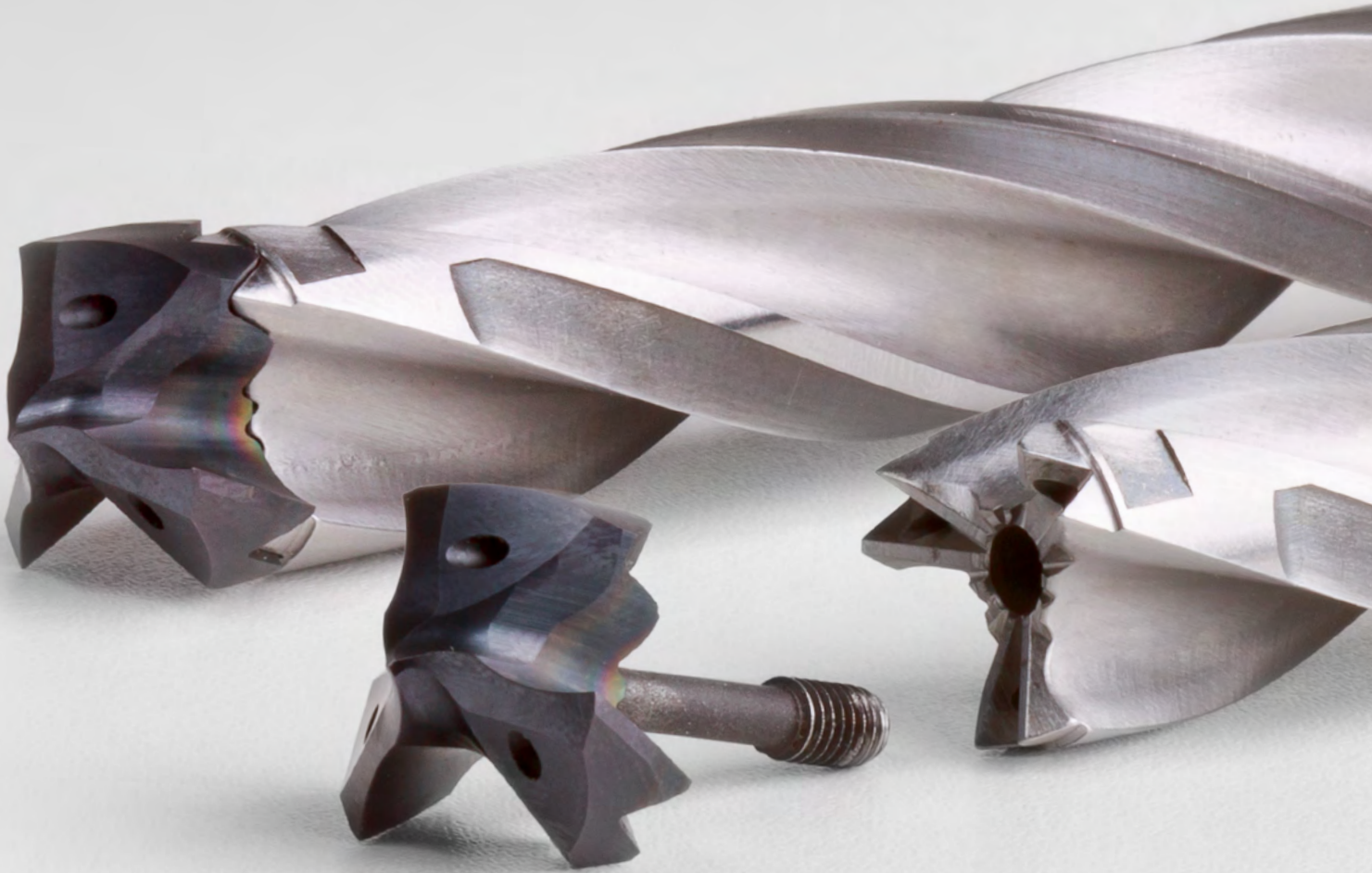

TTD-TRITAN REPLACEABLE HEAD DRILL

Minimised usage of carbide with highest stability and precision

The triple-edge Tritan-Drill is also available as a replaceable head variant.

The tool head and tool holder are joined by Hirth serrations. This connection is particularly stable so that all the benefits and the performance level of the solid carbide equivalent are fully retained with the replaceable head variant. The stability of the connection derives among other things from the triple edge that is predestined for a replaceable head system.

The three cutting edges ensure a homogeneous load on the connection so that the forces occurring during machining are transmitted uniformly to the steel tool holder. In addition, the cut guarantees optimal torque transmission while simultaneously achieving high changeover and radial run-out accuracy.

Compared to double edged replaceable head drills produced of solid carbide, feed rates up to twice as high can be realised using the TTD-Tritan.

As a result, it can be used reliably and stably even in difficult drilling situations, such as with inclined bore entrance or in cross bores. The tool can be perfectly centred via its pronounced drill tip and ensures very good roundness – at lower costs than with solid carbide drills too, because with the new replaceable head system, expensive carbide is only needed at the head. Lower costs are thus guaranteed even with large diameters.

Tool features in detail

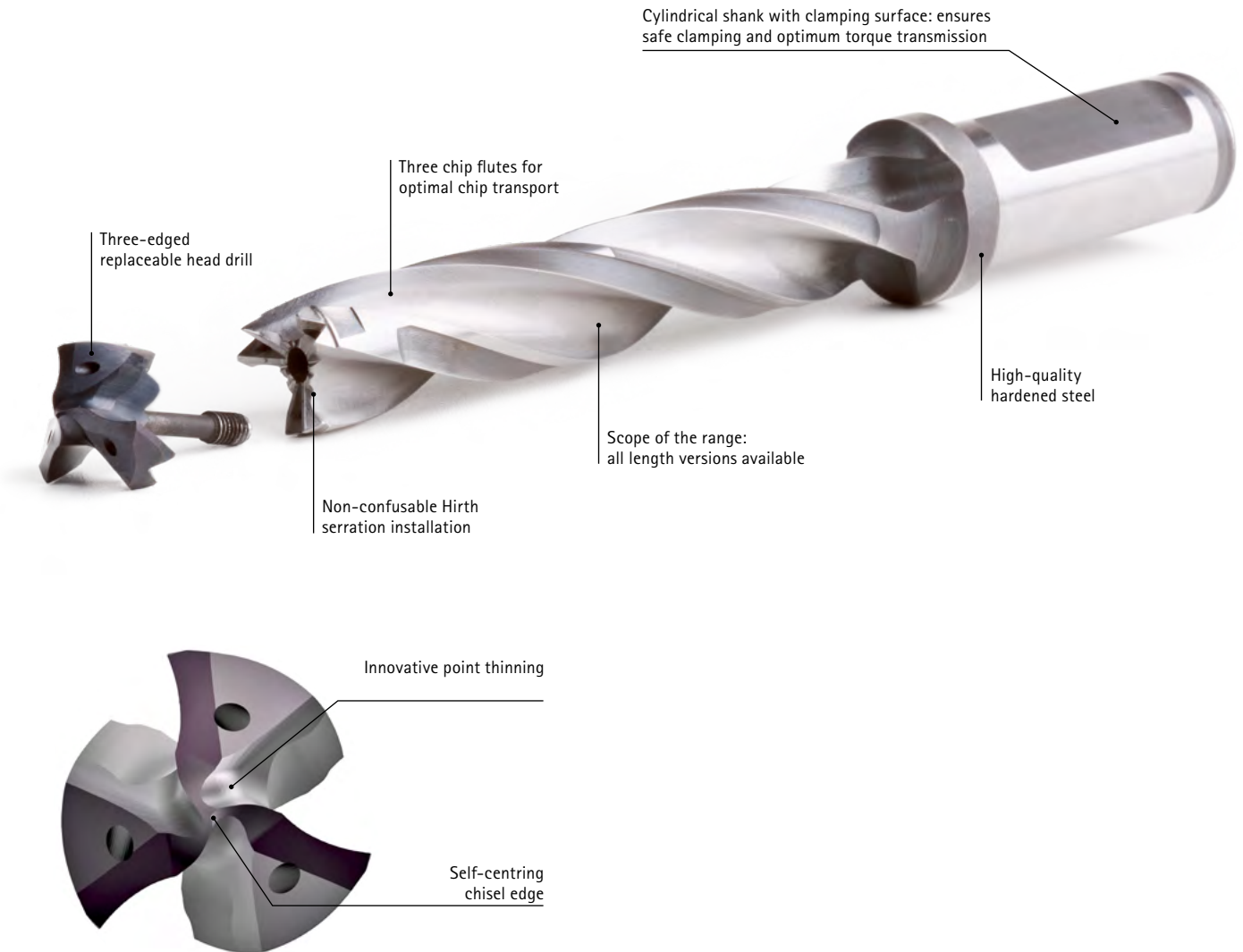

AT A GLANCE

- Three-edged replaceable head drill
- \varnothing range 12.00 to 32.49 mm
- Drilling depths 3 | 5 and 8xD
- With internal cooling
- Easy handling
- Head replacement on the machine possible

PERFORMANCE FEATURES

- Up to twice the feed compared to double edged replaceable head drills
- High exchange accuracy and radial run-out accuracy
- Ideal for inclined bore entrances
- Tool centres optimally due to its pronounced drill tip
- High level of torque transmission

ADVANTAGES

- Significant increase in feed rate and tool life
- Tritan geometry for good bore results
- High process reliability and stability even in difficult drilling situations
- Homogeneous load on the connection due to the three cutting edges

TTD-Tritan replaceable drill head

Produced from solid carbide, internal coolant supply
Type 01 - Uni

Design:
 Drill diameter: 12.00 – 32.49 mm
 Bore tolerance: IT 9 (achievable)
 Cutting material: HP926
 Number of cutting edges: 3
 Number of guiding chamfers: 3
 Tip angle: 140°

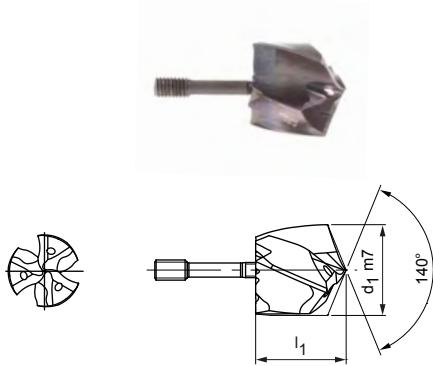

Stocked preferred series

d ₁ from 13.50 to 20.00		
d ₁ m7	Specification	Order no.
13,50	TTD300-3F01-1350-HP926	30871173
14,00	TTD300-3F01-1400-HP926	30871178
14,40	TTD300-3F01-1440-HP926	30871182
14,60	TTD300-3F01-1460-HP926	30871184
15,00	TTD300-3F01-1500-HP926	30871188
15,10	TTD300-3F01-1510-HP926	30871189
15,20	TTD300-3F01-1520-HP926	30871190
15,38	TTD300-3F01-1538-HP926	31290822
15,40	TTD300-3F01-1540-HP926	30871192
16,00	TTD300-3F01-1600-HP926	30871198
16,50	TTD300-3F01-1650-HP926	30871203
17,00	TTD300-3F01-1700-HP926	30871209
17,50	TTD300-3F01-1750-HP926	30871214
18,00	TTD300-3F01-1800-HP926	30871219
18,50	TTD300-3F01-1850-HP926	30871224
19,00	TTD300-3F01-1900-HP926	30871229
19,80	TTD300-3F01-1980-HP926	30871237
20,00	TTD300-3F01-2000-HP926	30871239

d ₁ from 20.50 to 32.00		
d ₁ m7	Specification	Order no.
20,50	TTD300-3F01-2050-HP926	30871244
21,00	TTD300-3F01-2100-HP926	30871249
22,00	TTD300-3F01-2200-HP926	30871259
24,00	TTD300-3F01-2400-HP926	30871279
24,70	TTD300-3F01-2470-HP926	30871287
25,00	TTD300-3F01-2500-HP926	30871290
25,10	TTD300-3F01-2510-HP926	30871291
25,20	TTD300-3F01-2520-HP926	30871292
26,00	TTD300-3F01-2600-HP926	30871300
26,10	TTD300-3F01-2610-HP926	30871301
26,50	TTD300-3F01-2650-HP926	30871305
27,00	TTD300-3F01-2700-HP926	30871310
27,10	TTD300-3F01-2710-HP926	30871311
28,00	TTD300-3F01-2800-HP926	30871320
28,50	TTD300-3F01-2850-HP926	30871325
31,00	TTD300-3F01-3100-HP926	30871350
32,00	TTD300-3F01-3200-HP926	30871360

Configurable features



Diameter:
Diameter in increments of 0.01 mm freely selectable

Specification:
TTD300-3F01-[diameter]-HP929

Dimensions of configurable series

d ₁ min.	d ₁ max.
12,00	32,49

Example:
TTD300-4F03-1401-HP619

Tool diameter d₁ = 14.01 mm

Dimensions in mm.
 For cutting data recommendations, see end of chapter.
 Special designs and other coatings available upon request.

TTS replaceable head holder

TTS300 with axial clamping system for TTD-Tritan (3xD) replaceable head drill, internal coolant supply

Design:

Drill diameter: 12.00 – 32.49 mm
Changing system: Central clamping over coolant bore

Comment:

Assembly tool included in scope of delivery.

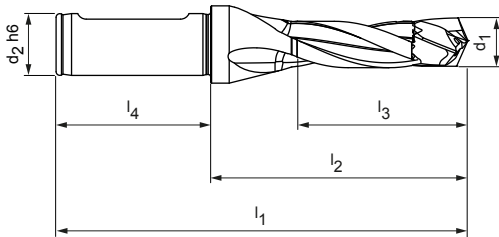
Stocked preferred series

Dimensions						Shank form HB	
d ₁	d ₂ h6	l ₁	l ₂	l ₃	l ₄	Specification	Order no.
14,00 - 14,49	16	120	72	48	48	TTS300B-1400-DR3-ZYL-16-MN	30839684
14,50 - 14,99	16	122	74	49	48	TTS300B-1450-DR3-ZYL-16-MN	30839685
15,00 - 15,49	16	124	76	51	48	TTS300B-1500-DR3-ZYL-16-MN	30839686
17,50 - 18,49	20	140	90	61	50	TTS300B-1750-DR3-ZYL-20-MN	30839689
18,50 - 19,49	25	150	94	64	56	TTS300B-1850-DR3-ZYL-25-MN	30839690
20,50 - 21,49	25	159	103	71	56	TTS300B-2050-DR3-ZYL-25-MN	30839692
21,50 - 22,49	25	164	108	74	56	TTS300B-2150-DR3-ZYL-25-MN	30839693
24,50 - 25,49	32	182	122	84	60	TTS300B-2450-DR3-ZYL-32-MN	30839696
26,50 - 27,49	32	191	131	91	60	TTS300B-2650-DR3-ZYL-32-MN	30839698

Available on request

Dimensions						Shank form HB	
d ₁	d ₂ h6	l ₁	l ₂	l ₃	l ₄	Specification	Order no.
12,00 - 12,49	16	111	63	39	48	TTS300B-1200-DR3-ZYL-16-MN	30839680
12,50 - 12,99	16	113	65	43	48	TTS300B-1250-DR3-ZYL-16-MN	30839681
13,00 - 13,49	16	115	67	45	48	TTS300B-1300-DR3-ZYL-16-MN	30839682
13,50 - 13,99	16	117	69	46	48	TTS300B-1350-DR3-ZYL-16-MN	30839683
15,50 - 16,49	20	131	81	54	50	TTS300B-1550-DR3-ZYL-20-MN	30839687
16,50 - 17,49	20	135	85	58	50	TTS300B-1650-DR3-ZYL-20-MN	30839688
19,50 - 20,49	25	155	99	68	56	TTS300B-1950-DR3-ZYL-25-MN	30839691
22,50 - 23,49	25	168	112	78	56	TTS300B-2250-DR3-ZYL-25-MN	30839694
23,50 - 24,49	25	173	117	81	56	TTS300B-2350-DR3-ZYL-25-MN	30839695
25,50 - 26,49	32	186	126	87	60	TTS300B-2550-DR3-ZYL-32-MN	30839697
27,50 - 28,49	32	195	135	94	60	TTS300B-2750-DR3-ZYL-32-MN	30839699
28,50 - 29,49	32	200	140	97	60	TTS300B-2850-DR3-ZYL-32-MN	30839700
29,50 - 30,49	32	204	144	101	60	TTS300B-2950-DR3-ZYL-32-MN	30839701
30,50 - 31,49	32	209	149	104	60	TTS300B-3050-DR3-ZYL-32-MN	30839702
31,50 - 32,49	32	213	153	107	60	TTS300B-3150-DR3-ZYL-32-MN	30839703

Dimensions in mm.

Special designs available upon request.

TTS replaceable head holder

TTS300 with axial clamping system for TTD-Tritan (5xD) replaceable head drill, internal coolant supply

Design:

Drill diameter: 12.00 – 32.49 mm
Changing system: Central clamping over coolant bore

Comment:

Assembly tool included in scope of delivery.

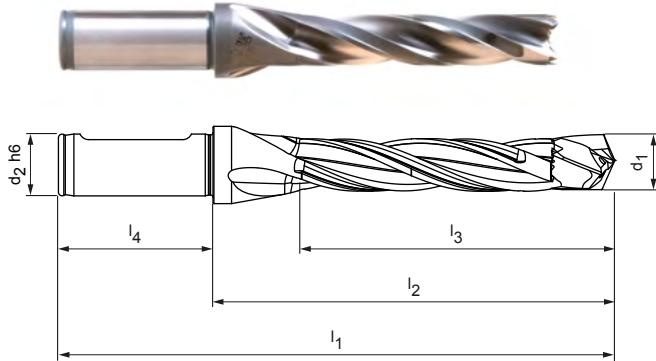
Stocked preferred series

Dimensions						Shank form HB	
d ₁	d ₂ h6	l ₁	l ₂	l ₃	l ₄	Specification	Order no.
14,00 - 14,49	16	149	101	77	48	TTS300B-1400-DR5-ZYL-16-MN	30839708
15,00 - 15,49	16	155	107	82	48	TTS300B-1500-DR5-ZYL-16-MN	30839710
16,50 - 17,49	20	170	120	93	50	TTS300B-1650-DR5-ZYL-20-MN	30839712
17,50 - 18,49	20	177	127	98	50	TTS300B-1750-DR5-ZYL-20-MN	30839713
23,50 - 24,49	25	222	166	130	56	TTS300B-2350-DR5-ZYL-25-MN	30839719
24,50 - 25,49	32	233	173	135	60	TTS300B-2450-DR5-ZYL-32-MN	30839720
26,50 - 27,49	32	246	186	146	60	TTS300B-2650-DR5-ZYL-32-MN	30839722

Available on request

Dimensions						Shank form HB	
d ₁	d ₂ h6	l ₁	l ₂	l ₃	l ₄	Specification	Order no.
12,00 - 12,49	16	136	88	66	48	TTS300B-1200-DR5-ZYL-16-MN	30839704
12,50 - 12,99	16	139	91	69	48	TTS300B-1250-DR5-ZYL-16-MN	30839705
13,00 - 13,49	16	142	94	71	48	TTS300B-1300-DR5-ZYL-16-MN	30839706
13,50 - 13,99	16	145	97	74	48	TTS300B-1350-DR5-ZYL-16-MN	30839707
14,50 - 14,99	16	152	104	79	48	TTS300B-1450-DR5-ZYL-16-MN	30839709
15,50 - 16,49	20	164	114	87	50	TTS300B-1550-DR5-ZYL-20-MN	30839711
18,50 - 19,49	25	189	133	103	56	TTS300B-1850-DR5-ZYL-25-MN	30839714
19,50 - 20,49	25	196	140	109	56	TTS300B-1950-DR5-ZYL-25-MN	30839715
20,50 - 21,49	25	202	146	114	56	TTS300B-2050-DR5-ZYL-25-MN	30839716
21,50 - 22,49	25	209	153	119	56	TTS300B-2150-DR5-ZYL-25-MN	30839717
22,50 - 23,49	25	215	159	124	56	TTS300B-2250-DR5-ZYL-25-MN	30839718
25,50 - 26,49	32	239	179	140	60	TTS300B-2550-DR5-ZYL-32-MN	30839721
27,50 - 28,49	32	252	192	151	60	TTS300B-2750-DR5-ZYL-32-MN	30839723
28,50 - 29,49	32	259	199	156	60	TTS300B-2850-DR5-ZYL-32-MN	30839724
29,50 - 30,49	32	265	205	162	60	TTS300B-2950-DR5-ZYL-32-MN	30839725
30,50 - 31,49	32	272	212	167	60	TTS300B-3050-DR5-ZYL-32-MN	30839726
31,50 - 32,49	32	278	218	172	60	TTS300B-3150-DR5-ZYL-32-MN	30839727

Dimensions in mm.

Special designs available upon request.

TTS replaceable head holder

TTS300 with axial clamping system for TTD-Tritan (8xD) replaceable head drill, internal coolant supply

Design:

Drill diameter: 12.00 – 32.49 mm
Changing system: Central clamping over coolant bore

Comment:

Assembly tool included in scope of delivery.

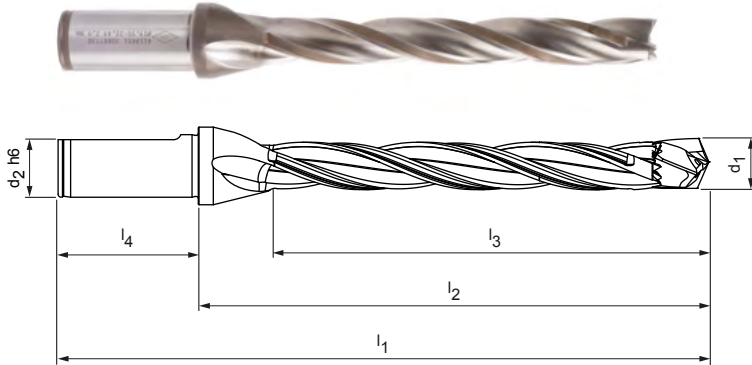

Stocked preferred series

Dimensions						Shank form HB	
d ₁	d ₂ h6	l ₁	l ₂	l ₃	l ₄	Specification	Order no.
15,50 - 16,49	20	213	163	137	50	TTS300B-1550-DR8-ZYL-20-MN	30867702
20,50 - 21,49	25	267	211	178	56	TTS300B-2050-DR8-ZYL-25-MN	30867707

Available on request

Dimensions						Shank form HB	
d ₁	d ₂ h6	l ₁	l ₂	l ₃	l ₄	Specification	Order no.
12,00 - 12,49	16	173	125	104	48	TTS300B-1200-DR8-ZYL-16-MN	30867695
12,50 - 12,99	16	178	130	108	48	TTS300B-1250-DR8-ZYL-16-MN	30867696
13,00 - 13,49	16	183	135	112	48	TTS300B-1300-DR8-ZYL-16-MN	30867697
13,50 - 13,99	16	187	139	116	48	TTS300B-1350-DR8-ZYL-16-MN	30867698
14,00 - 14,49	16	192	144	120	48	TTS300B-1400-DR8-ZYL-16-MN	30867699
14,50 - 14,99	16	197	149	124	48	TTS300B-1450-DR8-ZYL-16-MN	30867700
15,00 - 15,49	16	202	154	129	48	TTS300B-1500-DR8-ZYL-16-MN	30867701
16,50 - 17,49	20	223	173	145	50	TTS300B-1650-DR8-ZYL-20-MN	30867703
17,50 - 18,49	20	232	182	153	50	TTS300B-1750-DR8-ZYL-20-MN	30867704
18,50 - 19,49	25	248	192	162	56	TTS300B-1850-DR8-ZYL-25-MN	30867705
19,50 - 20,49	25	257	201	170	56	TTS300B-1950-DR8-ZYL-25-MN	30867706
21,50 - 22,49	25	276	220	187	56	TTS300B-2150-DR8-ZYL-25-MN	30867708
22,50 - 23,49	25	286	230	195	56	TTS300B-2250-DR8-ZYL-25-MN	30867709
23,50 - 24,49	25	295	239	203	56	TTS300B-2350-DR8-ZYL-25-MN	30867710
24,50 - 25,49	32	309	249	212	60	TTS300B-2450-DR8-ZYL-32-MN	30867711
25,50 - 26,49	32	319	259	220	60	TTS300B-2550-DR8-ZYL-32-MN	30885879
26,50 - 27,49	32	328	268	228	60	TTS300B-2650-DR8-ZYL-32-MN	30867713
27,50 - 28,49	32	338	278	236	60	TTS300B-2750-DR8-ZYL-32-MN	30867714
28,50 - 29,49	32	342	282	245	60	TTS300B-2850-DR8-ZYL-32-MN	30867715
29,50 - 30,49	32	352	292	253	60	TTS300B-2950-DR8-ZYL-32-MN	30867716
30,50 - 31,49	32	361	301	261	60	TTS300B-3050-DR8-ZYL-32-MN	30867717
31,50 - 32,49	32	371	311	270	60	TTS300B-3150-DR8-ZYL-32-MN	30867718

Dimensions in mm.

Special designs available upon request.



Accessories and spare parts for TTD-Tritan



TORX® wrench

Diameter range TTD-Tritan replaceable drill head	Torx	Tightening torque special clamping screw [Nm]	Order no.
			For tool holder lengths 3xD, 5xD and 8xD
12,00 - 12,49	6	0,4	30890316
12,50 - 12,99			
13,00 - 13,49			
13,50 - 13,99			
14,00 - 14,49	7	0,7	30890318
14,50 - 14,99			
15,00 - 15,49			
15,50 - 16,49			
16,50 - 17,49	8	1,3	30890321
17,50 - 18,49			
18,50 - 19,49			
19,50 - 20,49			
20,50 - 21,49	10	2	30890323
21,50 - 22,49			
22,50 - 23,49			
23,50 - 24,49			
24,50 - 25,49	15	3,1	30890326
25,50 - 26,49			
26,50 - 27,49			
27,50 - 28,49			
28,50 - 29,49		5,6	
29,50 - 30,49			
30,50 - 31,49			
31,50 - 32,49			

Torque wrench

Accessories	Tightening torque range [Nm]	Order no.
Torque wrench 	0,2 - 1,2	30911425
Torque wrench 	1,0 - 6,0	30911426

Handle for TORX® wrench

Spare part	Attachment shank	Order no.
Multi-grip 	Internal hexagon 1/4"	30918896

Cutting data recommendation for TTD-Tritan replaceable head drills

Feed and cutting speed

Type 01 – Uni

MMG*		Workpiece material	Strength/hardness [N/mm ²] [HRC]
P	P1	P1.1 Structural, free-cutting, case hardened and heat-treated steels, non-alloy	< 700
		P1.2 Structural, free-cutting, case hardened and heat-treated steels, non-alloy	< 1,200
	P2	P2.1 Nitrided, case hardened and heat-treated steels, alloy	< 900
		P2.2 Nitrided, case hardened and heat-treated steels, alloy	< 1,400
	P3	P3.1 Tool, bearing, spring and high-speed steels**	< 800
		P3.2 Tool, bearing, spring and high-speed steels**	< 1,000
		P3.3 Tool, bearing, spring and high-speed steels**	< 1,500
	P5	P5.1 Cast steel	
K	K1	K1.1 Cast iron with lamellar graphite (grey cast iron), GJL	< 300
		K2.1 Cast iron with spheroidal graphite, GJS	< 500
	K2	K2.2 Cast iron with spheroidal graphite, GJS	≤ 800
		K2.3 Cast iron with spheroidal graphite, GJS	> 800
	K3	K3.1 Cast iron with spheroidal graphite, GJV; malleable cast iron, GJM	< 500
		K3.2 Cast iron with spheroidal graphite, GJV; malleable cast iron, GJM	> 500

* MAPAL machining groups

** If the alloy parts Cr, Mo, Ni, V, W in total > 8% then select the next highest MAPAL machining group.

	Cutting speed v_c [m/min]				Feed f [mm] for drill diameter					
	Internal cooling	External cooling	MQL	Air	12.00	14.50	17.50	21.50	26.00	32.00
	90	80	80		0.38	0.42	0.46	0.50	0.53	0.54
	80	70	70		0.47	0.53	0.58	0.63	0.66	0.68
	90	75	75		0.45	0.50	0.55	0.59	0.62	0.64
	65	55	55		0.36	0.40	0.43	0.47	0.49	0.51
	70	60	60		0.40	0.45	0.49	0.53	0.56	0.58
	55	50	50		0.33	0.37	0.40	0.43	0.46	0.47
	55	40	45		0.26	0.28	0.31	0.33	0.35	0.36
	90	75	75		0.45	0.50	0.55	0.59	0.62	0.64
	110	75	75	75	0.62	0.69	0.77	0.83	0.88	0.90
	145	90	110	110	0.57	0.64	0.71	0.77	0.81	0.83
	90	70	70		0.49	0.55	0.61	0.66	0.69	0.71
	55	35	45		0.33	0.37	0.40	0.43	0.46	0.47
	80	70	70		0.53	0.59	0.65	0.71	0.75	0.77
	70	65	65		0.43	0.47	0.52	0.56	0.59	0.61

The specified cutting values are guide values.

The optimum data for the respective machining task should be determined during the test or machining.

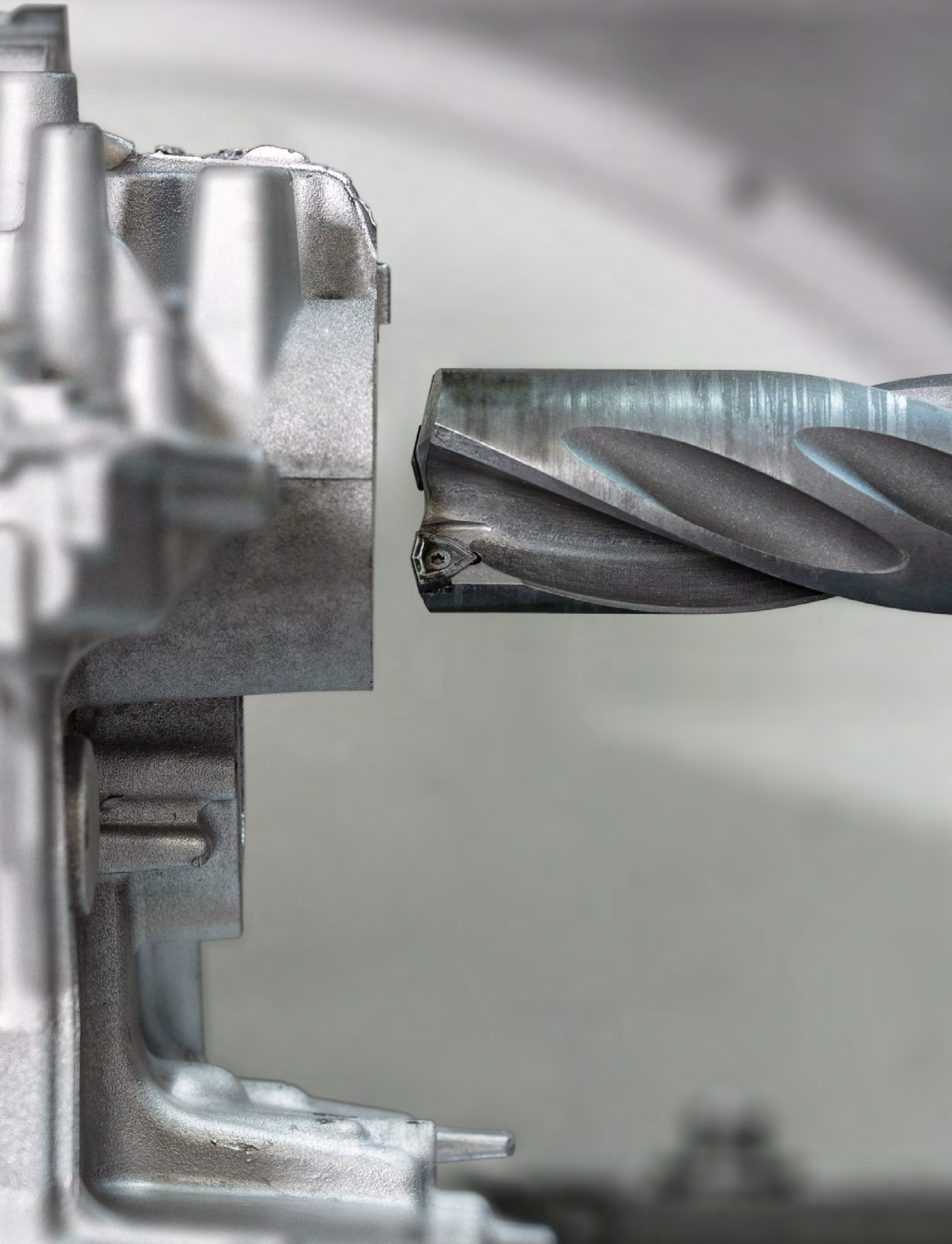



DRILLING FROM THE SOLID USING INDEXABLE INSERTS

Drilling from the solid using indexable inserts

Indexable insert drill _____	240
WOGT radial indexable insert, three cutting edges _____	241

Technical appendix

Cutting data recommendation for indexable insert drills _____	242
Instructions for use _____	744

DRILLING FROM THE SOLID USING INDEXABLE INSERTS

The indexable inserts for drilling aluminium from solid impress with three usable cutting edges and a high-performance CVD diamond coating. The cutting edges are available in five sizes. This allows their use in a very wide range of applications.

The single- or multi-stage custom tools are characterised by extremely high economic efficiency and simple handling.



From practice

Material: AISi1 v_c : 800 - 1000 m/min
 Diameter: 39.0 mm f: 0.30 - 0.45 mm
 Drilling depth: 65 mm

Tool life per cutting edge

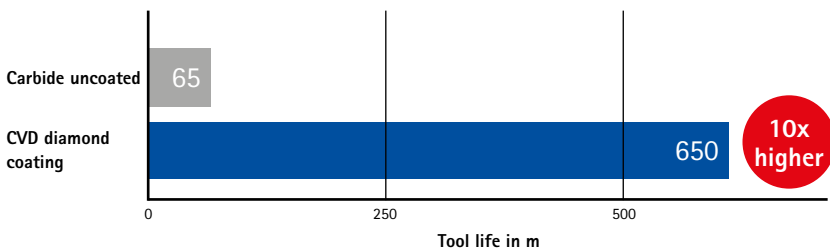

AT A GLANCE

- Customer-specific solutions for: \varnothing 16 - 54.9 mm
- Drilling AISi1 to AISi12 from solid
- With internal cooling, MQL also possible
- Single- or multi-stage with indexable insert or PCD boring stage

ADVANTAGES

- Extremely economical with highest productivity
- Wide range of applications
- Easy handling



Five indexable insert sizes for the diameter range 16 to 54.9 mm.

WOGT

Radial indexable insert, three cutting edges

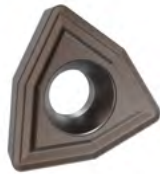

	Carbide	
Workpiece material	N	
	Al alloyed ← Wear-resistant	Cu alloyed → Tough/Ductile
Cutting material type	HC698	
Cutting edge design	X40	

ø range [mm]

WOGT030206N-...-...	16.0 - 20.9	31033174
WOGT040206N-...-...	21.0 - 25.9	31033175
WOGT053006N-...-...	26.0 - 30.9	31033177
WOGT063008N-...-...	31.0 - 44.9	30787196
WOGT073808N-...-...	45.0 - 54.9	31033178

For product ID code see page 676.

For cutting material overview see page 672.

Accessories for radial indexable inserts

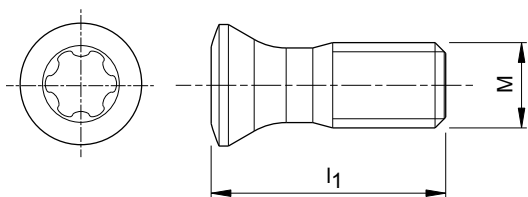

Indexable insert	Size of indexable insert	Clamping screw					Screwdriver
		Dimension [MxI]	Description	Tightening torque [Nm]	Torx size	Order no.	Order no.
WOGT... 	0302	M2x4.95	MN659 M2x4.95-TX6-IP	0,4	TX6-IP	10002712	30414758
	0402	M2.2x6	MN659 M2.2x6-TX7-IP	0,9	TX7-IP	31074485	30414759
	0530	M3x8.5	MN659 M3x8.5-TX8-IP	1,5	TX8-IP	31074486	30414760
	0630	M3.5x9	MN659 M3.5x9-TX15-IP	2,8	TX15-IP	10105078	30414764
	0738	M4x9.4	MN659 M4x9.4-TX15-IP	3,5	TX15-IP	30480629	30414764

Cutting data recommendation for indexable insert drills

Feed and cutting speed

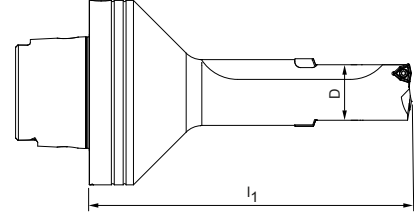

Indexable insert drills

Starting values for cutting speed and feed with WOGT...-X40-HC698

MMG*	Workpiece material	Strength/hardness [N/mm ²] [HRC]
N1	N1.1 Aluminium, non-alloy and alloy < 3 % Si	
	N1.2 Aluminium, alloy ≤ 7 % Si	
	N1.3 Aluminium, alloy > 7-12 % Si	
	N1.4 Aluminium, alloy > 12 % Si	
N2	N2.1 Copper, non-alloy and low-alloy	< 300
	N2.2 Copper, alloy	> 300
	N2.3 Brass, bronze, gunmetal	< 1,200
N3	N3.1 Graphite	
N4	N4.1 Plastic, thermoplastics	
	N4.2 Plastic, thermosets	
	N4.3 Plastic, foams	

Correction factor: Spot drilling / drill exit		
l_1	v_c	f_z
3xD	0.8	0.7
4xD	0.7	0.6
5xD	0.6	0.5

	Cutting speed v_c [m/min]	Feed f [mm] for drill diameter range [mm]				
		16.00 - 20.90	21.00 - 25.90	26.00 - 30.90	31.00 - 44.90	45.00 - 54.90
	300 - 1,000	0.08 - 0.20	0.12 - 0.22	0.14 - 0.30	0.16 - 0.40	0.20 - 0.45
	230 - 900	0.06 - 0.18	0.10 - 0.20	0.12 - 0.25	0.14 - 0.30	0.18 - 0.35
	220 - 800	0.05 - 0.15	0.08 - 0.18	0.10 - 0.20	0.12 - 0.25	0.15 - 0.30
	200 - 700	0.05 - 0.15	0.08 - 0.18	0.10 - 0.20	0.12 - 0.25	0.15 - 0.30

The specified cutting values are guide values.

The optimum data for the respective machining task should be determined during the test or machining.



SPOT DRILLING

Spotting drills

Tritan-Spot-Drill-Steel	246
ECU-Centre-Drill	248
CPD-Spot-Drill	249
CFS replaceable head holder	250

Technical appendix

Cutting data recommendations	251
------------------------------------	-----

Tritan-Spot-Drill-Steel

Solid carbide NC spotting drill
SCD670, external coolant supply

Design:

Drill diameter: 4.00 – 20.00 mm
Shank form: HA (DIN 6535)
Cutting material: HP358
Number of cutting edges: 3
Tip angle: 155°

Application:

Special NC spotting drill for the Tritan-Drill-Steel.

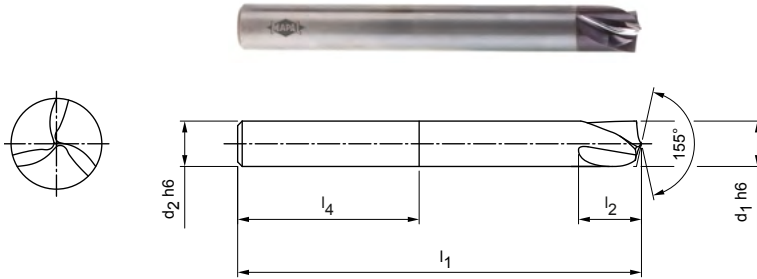

Stocked preferred series

Dimensions					Shank form HA	
d ₁ h6	d ₂ h6	l ₁	l ₂	l ₄	Specification	Order no.
4,00	4	55	6	28	SCD670-0400-3-0-155HA-HP358	30980587
5,00	6	62	7	36	SCD670-0500-3-0-155HA-HP358	30980588
6,00	6	66	9	36	SCD670-0600-3-0-155HA-HP358	30980589
8,00	8	79	11	36	SCD670-0800-3-0-155HA-HP358	30980590
10,00	10	89	14	40	SCD670-1000-3-0-155HA-HP358	30980592
12,00	12	102	17	45	SCD670-1200-3-0-155HA-HP358	30980594
16,00	16	115	23	48	SCD670-1600-3-0-155HA-HP358	30980595
20,00	20	131	28	50	SCD670-2000-3-0-155HA-HP358	30980596

Drilling depths

d ₁ h6	d ₂ h6	l ₁	l ₂	l ₄	Maximum drilling depth *	Minimum drilling depth **
4,00	4	55	6	28	0,40	0,24
5,00	6	62	7	36	0,50	0,30
6,00	6	66	9	36	0,60	0,36
8,00	8	79	11	36	0,80	0,48
10,00	10	89	14	40	1,00	0,60
12,00	12	102	17	45	1,20	0,72
16,00	16	115	23	48	1,60	0,96
20,00	20	131	28	50	2,00	1,20

* 10% from nominal Ø

** 6% from nominal Ø

Dimensions in mm.

For cutting data recommendations, see end of chapter.

Special designs and other coatings available upon request.

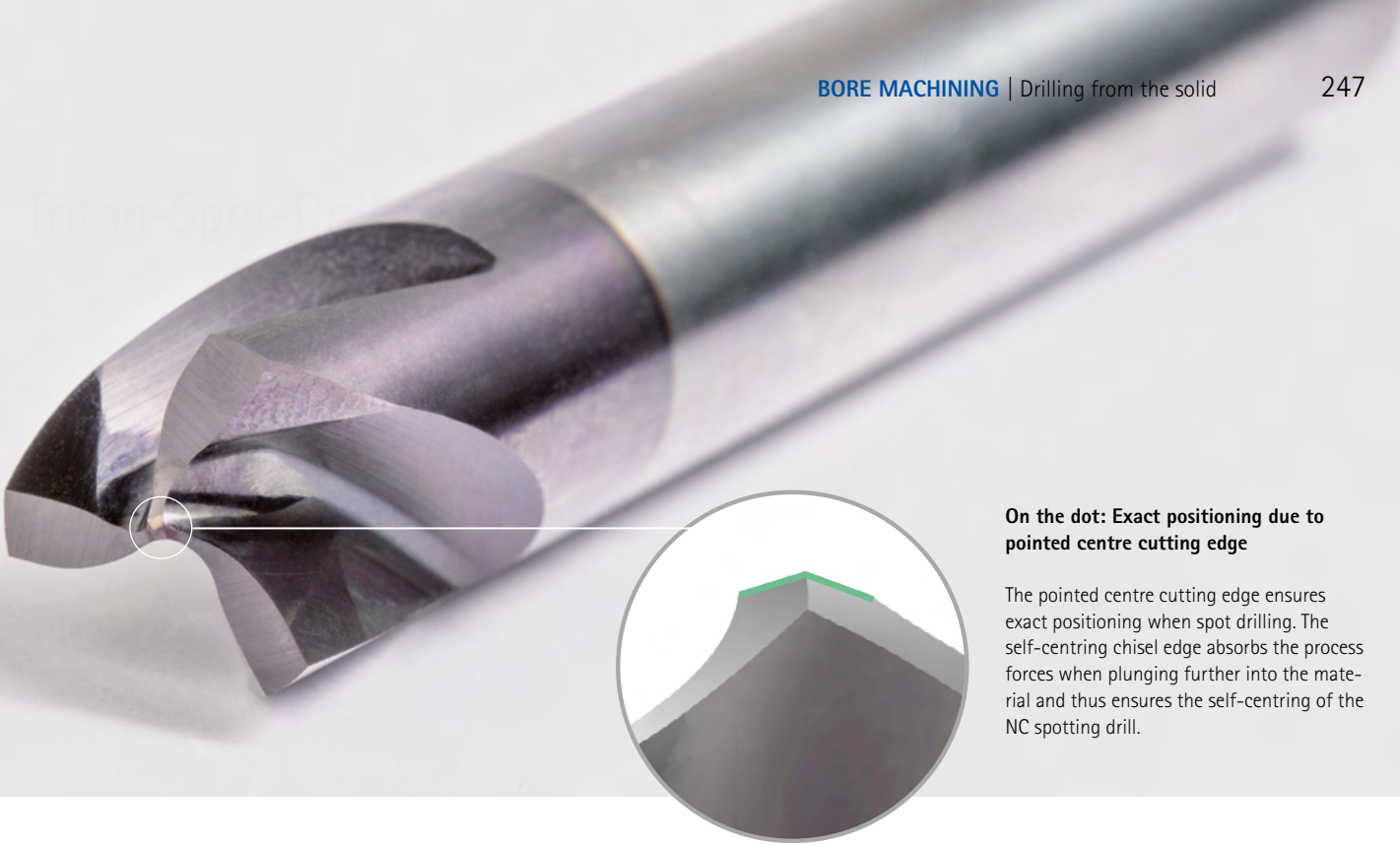

On the dot: Exact positioning due to pointed centre cutting edge

The pointed centre cutting edge ensures exact positioning when spot drilling. The self-centring chisel edge absorbs the process forces when plunging further into the material and thus ensures the self-centring of the NC spotting drill.

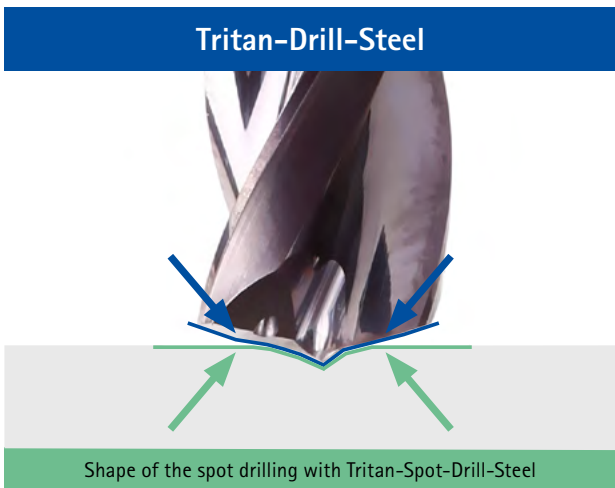

The tip angle of the Tritan-Spot-Drill-Steel (155°) and the Tritan-Drill-Steel (140°/145°) are perfectly harmonised.

The Tritan-Drill-Steel is available in:



Drilling strategy 3xD to 12xD:

Maximum spot drilling depth: 10%
(Nominal diameter information in %)

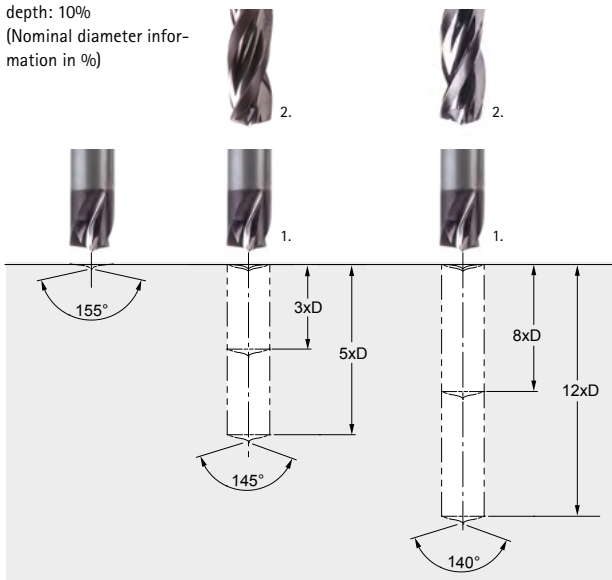

AT A GLANCE

- Three-edge NC spotting drill with 155° tip angle
- Perfectly matched to the Tritan-Drill-Steel
- High degree of positional accuracy
- Self-centring chisel edge
- Also suitable for challenging drilling situations

ECU-Centre-Drill

Solid carbide centre drill
SCD450

Design:

Drill diameter: 0.50 – 2.50 mm
Cutting material: HU318
Number of cutting edges: 2
Number of guiding chamfers: 2
Tip angle: 120°/60°
Side rake angle: 5°

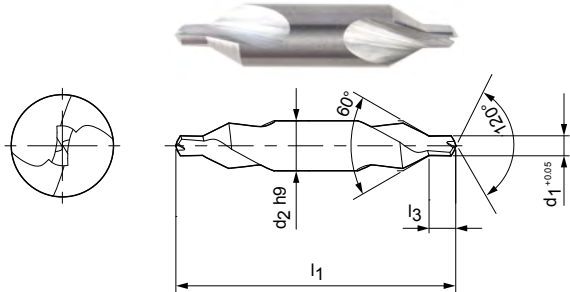

Stocked preferred series

Dimensions				Specification	Order no.
d_1 (0 +0.05)	d_2 h9	l_1	l_3		
0,50*	3,15	20	0,8	SCD450-0050-2-2-120HA-HU318	30561506
0,80*	3,15	20	1,1	SCD450-0080-2-2-120HA-HU318	30561507
1,00	3,15	31,5	1,3	SCD450-0100-2-2-120HA-HU318	30561508
1,25	3,15	31,5	1,6	SCD450-0125-2-2-120HA-HU318	30561509
1,60	4	35,5	2	SCD450-0160-2-2-120HA-HU318	30561510
2,00	5	40	2,5	SCD450-0200-2-2-120HA-HU318	30561511
2,50	6,3	45	3,1	SCD450-0250-2-2-120HA-HU318	30561512

Dimensions in mm.

* Single-side cutting.

For cutting data recommendations, see end of chapter.

Special designs and other coatings available upon request.

CPD-Spot-Drill

Design with CFS connection
CPD100

Design:
 Drill diameter: 8.00 – 20.00 mm
 Cutting material: HP338
 Number of cutting edges: 2
 Helix angle: 15°
 Tip angle: 90°

Application:
 Centre drilling.

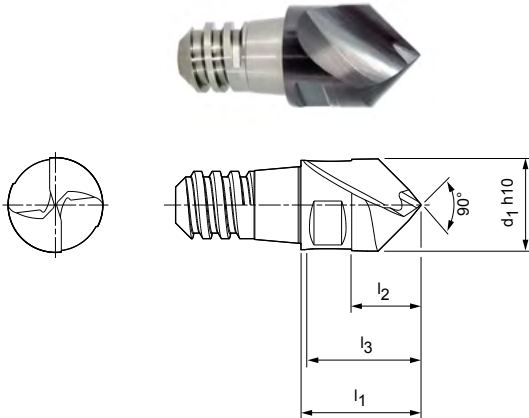

Stocked preferred series

Dimensions					z	a _p max.	SW	Specification	Order no.
d ₁ h10	CFS size	l ₁	l ₂	l ₃					
8,00	6	11	6	10	2	4	SW 6	CPD100-0800Z02-W090-06-HP338	30371388
10,00	8	13	7,5	12	2	5	SW 8	CPD100-1000Z02-W090-08-HP338	30371389
12,00	10	16	9	15	2	6	SW 10	CPD100-1200Z02-W090-10-HP338	30371390
16,00	12	20	12	18	2	8	SW 13	CPD100-1600Z02-W090-12-HP338	30371391
20,00	16	25	15	23	2	10	SW 16	CPD100-2000Z02-W090-16-HP338	30371393

Accessories

	CFS replaceable head holders CFS201	Page 250
---	--	----------

Dimensions in mm.
 For cutting data recommendations, see end of chapter.
 Special designs and other coatings available upon request.

CFS replaceable head holder

Conical design, with internal cooling

CFS201

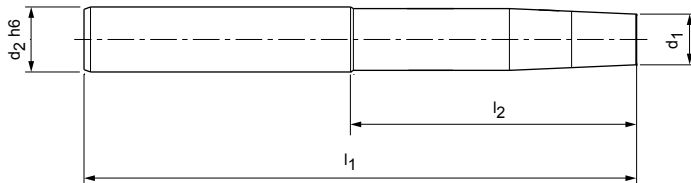

Design produced of steel

Dimensions					Specification	Order no.
CFS size	d_1	d_2 h6	l_1	l_2		
6	7,8	10	60	20	CFS201N-06-020-ZYL-HA10-S	30393776
8	9,8	16	70	30	CFS201N-08-030-ZYL-HA16-S	30393787
8	9,8	16	90	40	CFS201N-08-040-ZYL-HA16-S	30393788
10	11,8	16	70	30	CFS201N-10-030-ZYL-HA16-S	30393798
10	11,8	16	90	42	CFS201N-10-042-ZYL-HA16-S	30393799
12	15,8	20	80	30	CFS201N-12-030-ZYL-HA20-S	30393963
12	15,8	20	105	55	CFS201N-12-055-ZYL-HA20-S	30393964
16	19,8	25	90	40	CFS201N-16-040-ZYL-HA25-S	30393976

Design produced of carbide

6	7,8	10	110	70	CFS201N-06-070-ZYL-HA10-H	30393779
8	9,8	16	110	60	CFS201N-08-060-ZYL-HA16-H	30393790
10	11,8	20	110	60	CFS201N-10-060-ZYL-HA20-H	30393801
10	11,8	20	150	100	CFS201N-10-100-ZYL-HA20-H	30393802
12	15,8	20	130	80	CFS201N-12-080-ZYL-HA20-H	30393966
12	15,8	20	150	100	CFS201N-12-100-ZYL-HA20-H	30393967
16	19,8	25	150	94	CFS201N-16-094-ZYL-HA25-H	30393979

Cutting data recommendations for spotting drills

Feed and cutting speed

CPD-Spot-Drill | CPD100

MMG*		Workpiece material	Strength/ hardness [N/mm ²] [HRC]	Cooling			v _c [m/min]	f [mm]					
				MQL/Air	Dry	KSS		Drill diameter [mm]					
								8.00	10.00	12.00	16.00	20.00	
P	P1	P1.1	Structural, free-cutting, case hardened and heat-treated steels, non-alloy	< 700	✓	✓	✓	160	0.084	0.100	0.115	0.141	0.161
		P1.2	Structural, free-cutting, case hardened and heat-treated steels, non-alloy	< 1,200	✓	✓	✓	130	0.078	0.094	0.108	0.131	0.150
	P2	P2.1	Nitrided, case hardened and heat-treated steels, alloy	< 900	✓	✓	✓	145	0.084	0.100	0.115	0.141	0.161
		P2.2	Nitrided, case hardened and heat-treated steels, alloy	< 1,400	✓	✓	✓	100	0.070	0.084	0.096	0.117	0.134
	P3	P3.1	Tool, bearing, spring and high-speed steels**	< 800	✓	✓	✓	95	0.081	0.097	0.111	0.136	0.156
		P3.2	Tool, bearing, spring and high-speed steels**	< 1,000	✓	✓	✓	85	0.077	0.092	0.106	0.129	0.148
		P3.3	Tool, bearing, spring and high-speed steels**	< 1,500	✓	✓	✓	80	0.073	0.087	0.100	0.122	0.140
	P4	P4.1	Stainless steels, ferritic and martensitic		✓	✓	✓	65	0.056	0.067	0.077	0.094	0.107
	P5	P5.1	Cast steel		✓	✓	✓	95	0.081	0.097	0.111	0.136	0.156
	P6	P6.1	Stainless cast steel, ferritic and martensitic		✓	✓	✓	65	0.039	0.047	0.054	0.066	0.075
M	M1	M1.1	Stainless steels, austenitic	< 700	✓	✓	✓	45	0.049	0.059	0.067	0.082	0.094
		M1.2	Stainless steels, ferritic/austenitic (duplex)	< 1,000	✓	✓	✓	40	0.040	0.048	0.056	0.068	0.078
	M2	M2.1	Stainless/heat-resistant cast steel, austenitic	< 700	✓	✓	✓	50	0.053	0.064	0.073	0.089	0.102
	M3	M3.1	Stainless cast steel, ferritic/austenitic (duplex)	< 1,000	✓	✓	✓	45	0.042	0.050	0.058	0.070	0.081
K	K1	K1.1	Cast iron with lamellar graphite (grey cast iron), GJL	< 300	✓	✓	✓	175	0.140	0.167	0.192	0.235	0.268
		K2.1	Cast iron with spheroidal graphite, GJS	< 500	✓	✓	✓	160	0.119	0.142	0.163	0.199	0.228
	K2	K2.2	Cast iron with spheroidal graphite, GJS	500-800	✓	✓	✓	130	0.098	0.117	0.134	0.164	0.188
		K2.3	Cast iron with spheroidal graphite, GJS	> 800	✓	✓	✓	70	0.056	0.067	0.077	0.094	0.107
	K3	K3.1	Cast iron with spheroidal graphite, GJV; malleable cast iron, GJM	< 500	✓	✓	✓	115	0.098	0.117	0.134	0.164	0.188
		K3.2	Cast iron with spheroidal graphite, GJV; malleable cast iron, GJM	> 500	✓	✓	✓	110	0.084	0.100	0.115	0.141	0.161
N	N1	N1.1	Aluminium, non-alloy and alloy < 3 % Si		✓	✓	✓	610	0.142	0.170	0.196	0.239	0.273
		N1.2	Aluminium, alloyed < 7% Si		✓	✓	✓	405	0.149	0.179	0.206	0.251	0.287
		N1.3	Aluminium, alloy > 7-12 % Si		✓	✓	✓	325	0.156	0.187	0.215	0.263	0.301
		N1.4	Aluminium, alloy > 12 % Si		✓	✓	✓	235	0.171	0.204	0.235	0.287	0.328
	N2	N2.1	Copper, non-alloy and low-alloy	< 300	✓	✓	✓	235	0.114	0.136	0.157	0.191	0.219
		N2.2	Copper, alloy	> 300	✓	✓	✓	175	0.114	0.136	0.157	0.191	0.219
		N2.3	Brass, bronze, gunmetal	< 1,200	✓	✓	✓	295	0.071	0.085	0.098	0.120	0.137

* MAPAL machining groups

** If the alloy parts Cr, Mo, Ni, V, W in total > 8% then select the next highest MAPAL machining group.

The specified machining values are guide values.

The optimum data for the respective machining task should be determined during the test or machining.

Cutting data recommendations for spotting drills

Feed and cutting speed

Tritan-Spot-Drill-Steel | SCD670

MMG*		Workpiece material	Strength/hardness [N/mm ²] [HRC]
P	P1	P1.1 Structural, free-cutting, case hardened and heat-treated steels, non-alloy	< 700
		P1.2 Structural, free-cutting, case hardened and heat-treated steels, non-alloy	< 1,200
	P2	P2.1 Nitrided, case hardened and heat-treated steels, alloy	< 900
		P2.2 Nitrided, case hardened and heat-treated steels, alloy	< 1,400
	P3	P3.1 Tool, bearing, spring and high-speed steels**	< 800
		P3.2 Tool, bearing, spring and high-speed steels**	< 1,000
		P3.3 Tool, bearing, spring and high-speed steels**	< 1,500
P5	P5.1 Cast steel		
M	M1	M1.1 Stainless steels, austenitic	< 700
		M1.2 Stainless steels, ferritic/austenitic (duplex)	< 1,000
	M2	M2.1 Stainless/heat-resistant cast steel, austenitic	< 700
	M3	M3.1 Stainless cast steel, ferritic/austenitic (duplex)	< 1,000
K	K1	K1.1 Cast iron with lamellar graphite (grey cast iron), GJL	< 300
		K2.1 Cast iron with spheroidal graphite, GJS	< 500
	K2	K2.2 Cast iron with spheroidal graphite, GJS	≤ 800
		K2.3 Cast iron with spheroidal graphite, GJS	> 800
	K3	K3.1 Cast iron with spheroidal graphite, GJV; malleable cast iron, GJM	< 500
		K3.2 Cast iron with spheroidal graphite, GJV; malleable cast iron, GJM	> 500
N	N1	N1.1 Aluminium, non-alloy and alloy < 3 % Si	
		N1.2 Aluminium, alloy ≤ 7 % Si	
		N1.3 Aluminium, alloy > 7-12 % Si	
		N1.4 Aluminium, alloy > 12 % Si	
	N2	N2.1 Copper, non-alloy and low-alloy	< 300
		N2.2 Copper, alloy	> 300
		N2.3 Brass, bronze, gunmetal	< 1,200
	N4	N4.1 Plastic, thermoplastics	
		N4.2 Plastic, thermosets	
		N4.3 Plastic, foams	
S	S1	S1.1 Titanium, titanium alloys	< 400
		S2.1 Titanium, titanium alloys	< 1,200
	S2	S2.2 Titanium, titanium alloys	> 1,200
		S3.1 Nickel, unalloyed and alloyed	< 900
	S3	S3.2 Nickel, unalloyed and alloyed	> 900
		S4.1 High-temperature super alloy Ni, Co and Fe-based	
	S5	S5.1 Tungsten and molybdenum alloys	
H	H1	H1.1 Hardened steel/cast steel	< 44
		H1.2 Hardened steel/cast steel	< 55

* MAPAL machining groups

** If the alloy parts Cr, Mo, Ni, V, W in total > 8% then select the next highest MAPAL machining group.

	Cutting speed v_c [m/min]				Feed f [mm] for drill diameter					
	Internal cooling	External cooling	MQL	Air	4.00	5.50	7.50	10.50	14.50	20.00
	175	160	160		0.09	0.10	0.11	0.13	0.14	0.15
	160	130	130		0.11	0.12	0.14	0.16	0.17	0.18
	170	145	145		0.10	0.12	0.13	0.15	0.16	0.17
	120	100	100		0.08	0.09	0.11	0.12	0.13	0.14
	110	95	95		0.09	0.11	0.12	0.13	0.15	0.16
	90	85	85		0.08	0.09	0.10	0.11	0.12	0.13
	90	70	75		0.06	0.07	0.08	0.08	0.09	0.10
	110	95	95		0.10	0.12	0.13	0.15	0.16	0.17
	70	45	45		0.06	0.07	0.08	0.09	0.10	0.10
	75	50	50		0.06	0.07	0.08	0.09	0.10	0.10
	245	175	175	175	0.17	0.19	0.22	0.25	0.27	0.30
	225	140	170	170	0.16	0.18	0.20	0.23	0.25	0.27
	170	130	130		0.14	0.15	0.18	0.20	0.22	0.23
	100	70	85		0.09	0.10	0.12	0.13	0.14	0.15
	155	135	135		0.15	0.17	0.19	0.21	0.23	0.25
	135	120	120		0.12	0.13	0.15	0.17	0.19	0.20
	300	200	250		0.11	0.12	0.13	0.15	0.17	0.18
	250	180	200		0.14	0.15	0.18	0.20	0.22	0.23
	220	150	180		0.14	0.15	0.18	0.20	0.22	0.23
	180	120	150		0.14	0.15	0.18	0.20	0.22	0.23
	140	100			0.11	0.12	0.13	0.15	0.17	0.18
	120	90			0.14	0.15	0.18	0.20	0.22	0.23
	200	160	160	120	0.17	0.19	0.22	0.25	0.27	0.30
		60		50	0.09	0.10	0.12	0.13	0.14	0.15
		65		40	0.07	0.08	0.09	0.11	0.12	0.12
			400	0.07	0.08	0.09	0.11	0.12	0.12	
	40	25			0.062	0.069	0.078	0.088	0.097	0.104
	30	20			0.053	0.059	0.067	0.075	0.083	0.089
	25	15			0.044	0.050	0.056	0.063	0.069	0.074
	20	15			0.035	0.040	0.045	0.050	0.055	0.059
	15	10			0.044	0.050	0.056	0.063	0.069	0.074
	15	10			0.035	0.040	0.045	0.050	0.055	0.059
	15	10			0.035	0.040	0.045	0.050	0.055	0.059
	80	80	80		0.078	0.087	0.098	0.109	0.120	0.128
	30	30	30		0.053	0.059	0.067	0.075	0.083	0.089

The specified cutting values are guide values.

The optimum data for the respective machining task should be determined during the test or machining.

Cutting data recommendations for spotting drills

Feed and cutting speed

ECU-Centre-Drill | SCD450

MMG*		Workpiece material	Strength/hardness [N/mm ²] [HRC]
P	P1	P1.1 Structural, free-cutting, case hardened and heat-treated steels, non-alloy	< 700
		P1.2 Structural, free-cutting, case hardened and heat-treated steels, non-alloy	< 1,200
	P2	P2.1 Nitrided, case hardened and heat-treated steels, alloy	< 900
		P2.2 Nitrided, case hardened and heat-treated steels, alloy	< 1,400
	P3	P3.1 Tool, bearing, spring and high-speed steels**	< 800
		P3.2 Tool, bearing, spring and high-speed steels**	< 1,000
		P3.3 Tool, bearing, spring and high-speed steels**	< 1,500
	P4	P4.1 Stainless steels, ferritic and martensitic	
	P5	P5.1 Cast steel	
P6	P6.1 Stainless cast steel, ferritic and martensitic		
M	M1	M1.1 Stainless steels, austenitic	< 700
		M1.2 Stainless steels, ferritic/austenitic (duplex)	< 1,000
	M2	M2.1 Stainless/heat-resistant cast steel, austenitic	< 700
	M3	M3.1 Stainless cast steel, ferritic/austenitic (duplex)	< 1,000
N	N2	N2.1 Copper, non-alloy and low-alloy	< 300
		N2.2 Copper, alloy	> 300
		N2.3 Brass, bronze, gunmetal	< 1,200
S	S1	S1.1 Titanium, titanium alloys	< 400
		S2.1 Titanium, titanium alloys	< 1,200
	S2	S2.2 Titanium, titanium alloys	> 1,200
		S3.1 Nickel, unalloyed and alloyed	< 900
	S3	S3.2 Nickel, unalloyed and alloyed	> 900
		S4	S4.1 High-temperature super alloy Ni, Co and Fe-based
S5	S5.1 Tungsten and molybdenum alloys		

* MAPAL machining groups

** If the alloy parts Cr, Mo, Ni, V, W in total > 8% then select the next highest MAPAL machining group.

	Cutting speed v_c [m/min]				Feed f [mm] for drill diameter					
	Internal cooling	External cooling	MQL	Air	0.50	0.83	1.38	2.29	3.80	6.30
		70	70		0.01	0.01	0.02	0.02	0.03	0.04
		55	55		0.01	0.02	0.02	0.03	0.04	0.06
		65	65		0.01	0.01	0.02	0.03	0.04	0.05
		45	45		0.01	0.01	0.02	0.02	0.03	0.04
		50	50		0.01	0.01	0.02	0.02	0.03	0.05
		40	40		0.01	0.01	0.02	0.02	0.03	0.04
		35	40		0.01	0.01	0.01	0.02	0.02	0.03
		35	40		0.01	0.01	0.01	0.02	0.02	0.03
		65	65		0.01	0.01	0.02	0.03	0.04	0.05
		35	40		0.01	0.01	0.01	0.02	0.02	0.03
		30	30		0.01	0.01	0.01	0.02	0.02	0.03
		25	25		0.01	0.01	0.01	0.01	0.02	0.03
		30	30		0.01	0.01	0.01	0.02	0.02	0.03
		25	25		0.01	0.01	0.01	0.01	0.02	0.03
		85			0.01	0.01	0.02	0.02	0.03	0.04
		75			0.01	0.01	0.02	0.03	0.04	0.06
		135	135		0.01	0.01	0.02	0.03	0.04	0.07
		40	40		0.01	0.01	0.02	0.02	0.03	0.04
		35	35		0.01	0.01	0.02	0.02	0.03	0.04
		30	30		0.01	0.01	0.02	0.02	0.03	0.04
		25	25		0.01	0.01	0.02	0.02	0.03	0.04
		20	20		0.01	0.01	0.02	0.02	0.03	0.04
		20	20		0.01	0.01	0.02	0.02	0.03	0.04
		20	20		0.01	0.01	0.02	0.02	0.03	0.04

The specified cutting values are guide values.

The optimum data for the respective machining task should be determined during the test or machining.



STEPPED DRILLING

Step drill

Tritan-Step-Drill-Steel 258

MEGA-Step-Drill-Steel-Plus 259

Technical appendix

Cutting data recommendations 262

Tritan-Step-Drill-Steel

Solid carbide step drill
SCD561, internal coolant supply

Design:
 Drill diameter: 3.98 – 17.50 mm
 Bore tolerance: IT 9 (achievable)
 Cutting material: HP835
 Number of cutting edges: 3
 Number of guiding chamfers: 3
 Tip angle: 145°
 Helix angle: 30°

Application:
 For threaded core-bore drilling with 90° countersink.

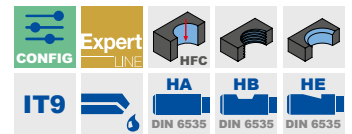
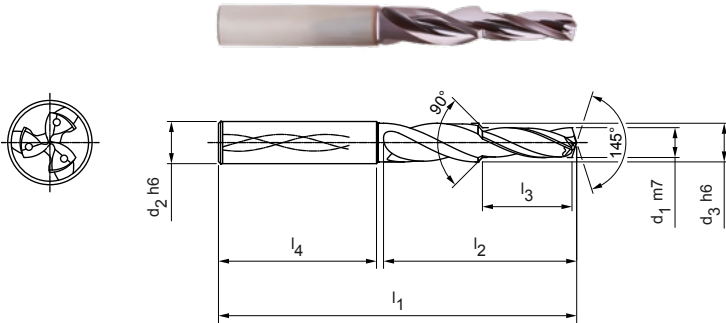

Stocked preferred series in shank form HA

Dimensions								Shank form HA	
For thread	d_1 m7	d_2 h6	d_3 h6	l_1	l_2	l_3	l_4	Specification	Order no.
M5	4,25	6	5,5	66	28	13,6	36	SCD561-0425-3-3-145HA-HP835	31053657
M6	5,10	8	6,6	79	41	16,5	36	SCD561-0510-3-3-145HA-HP835	31053658
M8	6,85	10	8,8	89	47	21	40	SCD561-0685-3-3-145HA-HP835	31053659
M8x1	7,10	10	8,8	89	47	21	40	SCD561-0710-3-3-145HA-HP835	31073436
M10	8,60	12	11	102	55	25,5	45	SCD561-0860-3-3-145HA-HP835	31053670
M10x1	9,10	12	11	102	55	25,5	45	SCD561-0910-3-3-145HA-HP835	31073438
M12	10,35	14	13,2	107	60	30	45	SCD561-1035-3-3-145HA-HP835	31053671
M16	14,15	18	17,6	123	73	38,5	48	SCD561-1415-3-3-145HA-HP835	31053672

Configurable features





Diameter:
Diameter in increments of 0.01 mm freely selectable





Step length
Step lengths in increments of 0,01 mm available





Shank form:
Shank form: HB | HE



Specification:
SCD561-[diameter]-3-3-145[shank form]-HP835

Example:
SCD561-0431-3-3-145HE-HP835

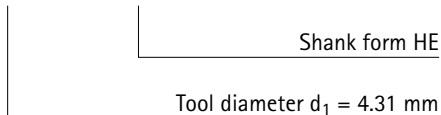

Dimensions in mm.
 For cutting data recommendations, see end of chapter.
 Special designs and other coatings available upon request.

Dimensions of configurable series

d_1 min.	d_1 max.	d_2 h6	d_3 h6	l_1	l_2	l_3 min.	l_3 max.
3,98	4,50	6	5	66	28	4,00	15,4
4,51	5,50	6	6	66	28	4,50	15,4
5,51	6,50	8	7	79	41	5,50	22,55
6,51	7,50	8	8	79	41	6,50	22,55
7,51	8,50	10	9	89	47	7,50	25,85
8,51	9,50	10	10	89	47	8,50	25,85
9,51	11,50	12	12	102	55	9,50	30,25
11,51	13,50	14	14	107	60	11,50	33
13,51	15,50	16	16	115	65	13,50	35,75
15,51	17,50	18	18	123	73	15,50	40,15

Core bore drilling with 90° chamfer

In accordance to DIN 8378 with the Tritan-Step-Drill-Steel





MEGA STEP DRILL STEEL PLUS

Cost-effective machining of spot drilling bores (in accordance with DIN 8378)

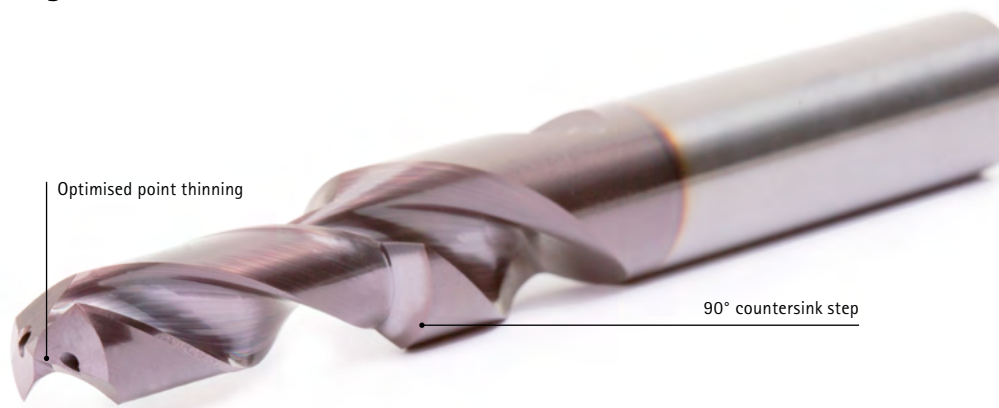
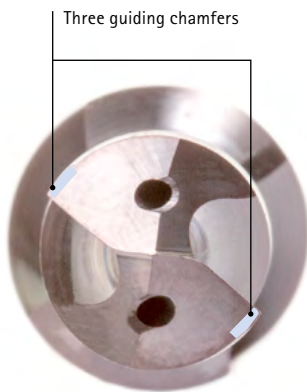

Core hole bore M10

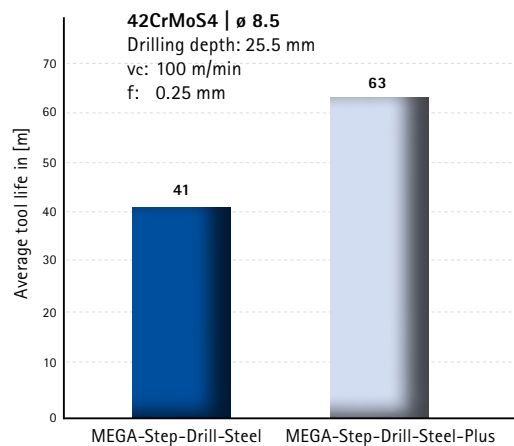
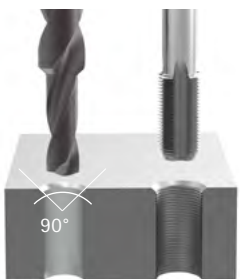

AT A GLANCE

- Upgrade of the MEGA-Step-Drill-Steel with and without IC
- Innovative coating
- Optimised micro and macro geometry
- Diameter range from 2.50 to 15.00 mm

ADVANTAGES

- 15 per cent higher cutting speeds*
- 15 per cent higher feed*
- 50 per cent longer tool life*

* Compared to the predecessor model

MEGA-Step-Drill-Steel-Plus

Solid carbide step drill

SCD590, external coolant supply, follow-up product to the MEGA-Step-Drill-Steel

Design:

Drill diameter: 2.50 – 15.00 mm
 Cutting material: HP358
 Number of cutting edges: 2
 Number of guiding chamfers: 2
 Tip angle: 140°
 Side rake angle: 30°

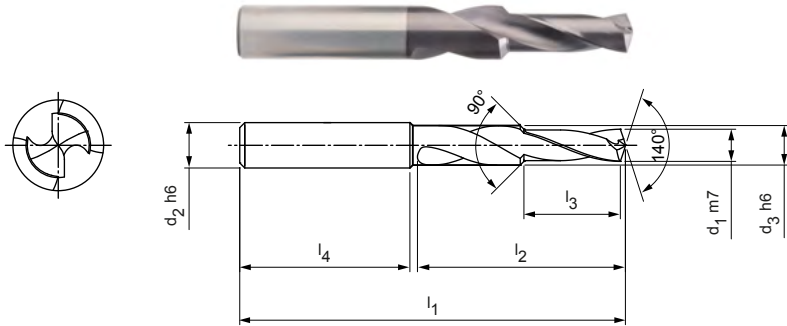

Stocked preferred series in shank form HA

Dimensions									Shank form HA	
For thread	Type	d ₁ m7	d ₂ h6	d ₃ h6	l ₁	l ₂	l ₃	l ₄	Specification	Order no.
M3	GB	2,50	6	6,00	62	20	8,8	36	SCD590-0250-2-2-140HA-HP358	31228957
M3	FO	2,80	6	6,00	62	20	8,8	36	SCD590-0280-2-2-140HA-HP358	31228958
M4	GB	3,30	6	6,00	62	24	11,4	36	SCD590-0330-2-2-140HA-HP358	31228959
M4	FO	3,70	6	6,00	62	24	11,4	36	SCD590-0370-2-2-140HA-HP358	31228960
M5	GB	4,20	6	6,00	66	28	13,6	36	SCD590-0420-2-2-140HA-HP358	31228961
M5	FO	4,65	6	6,00	66	28	13,6	36	SCD590-0465-2-2-140HA-HP358	31228962
M6	GB	5,00	8	8,00	79	34	16,5	36	SCD590-0500-2-2-140HA-HP358	31149619
M6	FO	5,55	8	8,00	79	34	16,5	36	SCD590-0555-2-2-140HA-HP358	31228963
M8	GB	6,80	10	10,00	89	47	21	40	SCD590-0680-2-2-140HA-HP358	31141315
M8	FO	7,45	10	10,00	89	47	21	40	SCD590-0745-2-2-140HA-HP358	31228964
M10	GB	8,50	12	12,00	102	55	25,5	45	SCD590-0850-2-2-140HA-HP358	31228965
M10	FO	9,30	12	12,00	102	55	25,5	45	SCD590-0930-2-2-140HA-HP358	31228966
M12	GB	10,20	14	14,00	107	60	30	45	SCD590-1020-2-2-140HA-HP358	31228967
M12	FO	11,20	14	14,00	107	60	30	45	SCD590-1120-2-2-140HA-HP358	31228968
M14	GB	12,00	16	16,00	115	65	34,5	48	SCD590-1200-2-2-140HA-HP358	31149650
M16	GB	14,00	18	18,00	123	73	38,5	48	SCD590-1400-2-2-140HA-HP358	31228970

GB: Core bore thread boring
 FO: Core bore thread forming / thread grooving

Configurable features



Shank form:
Shank form: HB | HE



Specification:
SCD590-0420-2-2-140[shank form]-HP358

Example:

SCD590-0420-2-2-140HE05-HP358

Shank form HE

MEGA-Step-Drill-Steel-Plus

Solid carbide step drill
 SCD591, internal coolant supply, follow-up product to the MEGA-Step-Drill-Steel

Design:
 Drill diameter: 3,30 - 14,00 mm
 Cutting material: HP358
 Number of cutting edges: 2
 Number of guiding chamfers: 2
 Tip angle: 140°
 Side rake angle: 30°

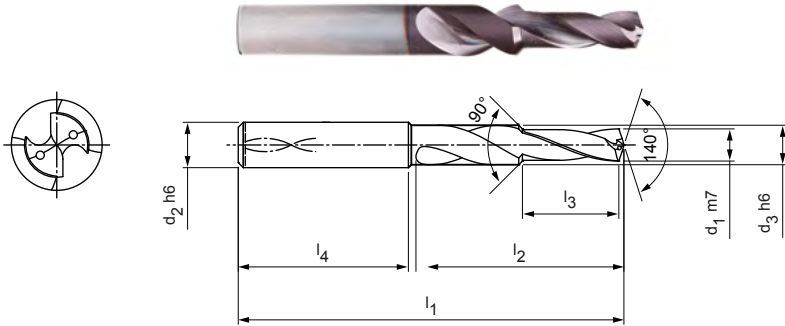

Stocked preferred series in shank form HA

Dimensions									Shank form HA	
For thread	Type	d ₁ m7	d ₂ h6	d ₃ h6	l ₁	l ₂	l ₃	l ₄	Specification	Order no.
M4	GB	3,30	6	6,00	62	24	11,4	36	SCD591-0330-2-2-140HA-HP358	31140987
M4	FO	3,70	6	6,00	62	24	11,4	36	SCD591-0370-2-2-140HA-HP358	31140988
M5	GB	4,20	6	6,00	66	28	13,6	36	SCD591-0420-2-2-140HA-HP358	31140989
M6	GB	5,00	8	8,00	79	34	16,5	36	SCD591-0500-2-2-140HA-HP358	31140991
M6	FO	5,55	8	8,00	79	34	16,5	36	SCD591-0555-2-2-140HA-HP358	31140992
M8	GB	6,80	10	10,00	89	47	21	40	SCD591-0680-2-2-140HA-HP358	31140993
M8	FO	7,45	10	10,00	89	47	21	40	SCD591-0745-2-2-140HA-HP358	31140994
M10	GB	8,50	12	12,00	102	55	25,5	45	SCD591-0850-2-2-140HA-HP358	31140995
M10	FO	9,30	12	12,00	102	55	25,5	45	SCD591-0930-2-2-140HA-HP358	31140996
M12	GB	10,20	14	14,00	107	60	30	45	SCD591-1020-2-2-140HA-HP358	31140997
M12	GB	10,20	14	14,00	107	60	30	45	SCD591-1020-2-2-140HA-HP358	31140997

Available on request

M12	FO	11,20	14	14,00	107	60	30	45	SCD591-1120-2-2-140HA-HP358	31140998
M16	GB	14,00	18	18,00	123	73	38,5	48	SCD591-1400-2-2-140HA-HP358	31140999

GB: Core bore thread boring
 FO: Core bore thread forming / thread grooving

Configurable features

Shank form:
 Shank form: HB | HE

Specification:
 SCD591-0420-2-2-140[shank form]-HP358

Example:
 SCD591-0420-2-2-140HE05-HP358

Shank form HE

Dimensions in mm.
 For cutting data recommendations, see end of chapter.
 Special designs and other coatings available upon request.

Cutting data recommendations for step drills

Feed and cutting speed

Tritan-Step-Drill-Steel | SCD561

MMG*		Workpiece material	Strength/hardness [N/mm ²] [HRC]
P	P1	P1.1 Structural, free-cutting, case hardened and heat-treated steels, non-alloy	< 700
		P1.2 Structural, free-cutting, case hardened and heat-treated steels, non-alloy	< 1,200
	P2	P2.1 Nitrided, case hardened and heat-treated steels, alloy	< 900
		P2.2 Nitrided, case hardened and heat-treated steels, alloy	< 1,400
	P3	P3.1 Tool, bearing, spring and high-speed steels**	< 800
		P3.2 Tool, bearing, spring and high-speed steels**	< 1,000
		P3.3 Tool, bearing, spring and high-speed steels**	< 1,500
	P5	P5.1 Cast steel	
M	M1	M1.1 Stainless steels, austenitic	< 700
		M1.2 Stainless steels, ferritic/austenitic (duplex)	< 1,000
K	K1	K1.1 Cast iron with lamellar graphite (grey cast iron), GJL	< 300
		K2.1 Cast iron with spheroidal graphite, GJS	< 500
	K2	K2.2 Cast iron with spheroidal graphite, GJS	≤ 800
		K2.3 Cast iron with spheroidal graphite, GJS	> 800
	K3	K3.1 Cast iron with spheroidal graphite, GJV; malleable cast iron, GJM	< 500
		K3.2 Cast iron with spheroidal graphite, GJV; malleable cast iron, GJM	> 500

* MAPAL machining groups

** If the alloy parts Cr, Mo, Ni, V, W in total > 8% then select the next highest MAPAL machining group.

	Cutting speed v_c [m/min]				Feed f [mm] for drill diameter					
	Internal cooling	External cooling	MQL	Air	4.00	5.50	7.50	10.50	14.50	20.00
	115	105	105		0.24	0.30	0.37	0.46	0.56	0.65
	105	85	85		0.30	0.37	0.46	0.58	0.70	0.81
	115	100	100		0.28	0.35	0.44	0.55	0.66	0.77
	80	70	70		0.24	0.29	0.36	0.44	0.53	0.61
	85	75	75		0.25	0.31	0.39	0.49	0.60	0.69
	70	65	65		0.21	0.26	0.33	0.41	0.49	0.56
	70	50	60		0.18	0.21	0.26	0.32	0.38	0.43
	115	100	100		0.28	0.35	0.44	0.55	0.66	0.77
	55	35	35		0.11	0.14	0.18	0.22	0.27	0.31
	140	100	100	100	0.36	0.45	0.55	0.67	0.80	0.91
	185	115	140	140	0.35	0.43	0.52	0.63	0.74	0.84
	115	85	85		0.31	0.38	0.46	0.55	0.64	0.73
	70	45	60		0.17	0.20	0.24	0.28	0.33	0.37
	105	90	90		0.34	0.41	0.49	0.59	0.69	0.78
	90	80	80		0.28	0.34	0.40	0.47	0.55	0.62

The specified cutting values are guide values.

The optimum data for the respective machining task should be determined during the test or machining.

Cutting data recommendations for step drills

Feed and cutting speed

MEGA-Step-Drill-Steel-Plus | SCD590, 591

MMG*		Workpiece material	Strength/hardness [N/mm ²] [HRC]
P	P1	P1.1 Structural, free-cutting, case hardened and heat-treated steels, non-alloy	< 700
		P1.2 Structural, free-cutting, case hardened and heat-treated steels, non-alloy	< 1,200
	P2	P2.1 Nitrided, case hardened and heat-treated steels, alloy	< 900
		P2.2 Nitrided, case hardened and heat-treated steels, alloy	< 1,400
	P3	P3.1 Tool, bearing, spring and high-speed steels**	< 800
		P3.2 Tool, bearing, spring and high-speed steels**	< 1,000
		P3.3 Tool, bearing, spring and high-speed steels**	< 1,500
	P4	P4.1 Stainless steels, ferritic and martensitic	
	P5	P5.1 Cast steel	
	P6	P6.1 Stainless cast steel, ferritic and martensitic	
K	K1	K1.1 Cast iron with lamellar graphite (grey cast iron), GJL	< 300
		K2.1 Cast iron with spheroidal graphite, GJS	< 500
	K2	K2.2 Cast iron with spheroidal graphite, GJS	≤ 800
		K2.3 Cast iron with spheroidal graphite, GJS	> 800
	K3	K3.1 Cast iron with spheroidal graphite, GJV; malleable cast iron, GJM	< 500
		K3.2 Cast iron with spheroidal graphite, GJV; malleable cast iron, GJM	> 500
H	H1	H1.1 Hardened steel/cast steel	< 44
		H1.2 Hardened steel/cast steel	< 55

* MAPAL machining groups

** If the alloy parts Cr, Mo, Ni, V, W in total > 8% then select the next highest MAPAL machining group.

	Cutting speed v_c [m/min]				Feed f [mm] for drill diameter					
	Internal cooling	External cooling	MQL	Air	2.50	3.70	5.00	7.45	10.20	15.00
	110	100	100		0.09	0.11	0.14	0.18	0.23	0.29
	100	85	85		0.11	0.14	0.18	0.23	0.29	0.36
	110	95	95		0.10	0.13	0.17	0.22	0.27	0.34
	75	65	65		0.09	0.11	0.14	0.18	0.22	0.27
	85	70	70		0.09	0.11	0.15	0.19	0.25	0.30
	65	60	60		0.08	0.10	0.13	0.16	0.20	0.25
	65	50	55		0.07	0.08	0.10	0.13	0.16	0.19
	65	50	55		0.06	0.08	0.10	0.13	0.16	0.20
	110	95	95		0.10	0.13	0.17	0.22	0.27	0.34
	65	50	55		0.06	0.08	0.10	0.13	0.16	0.20
	120	85	85	85	0.13	0.19	0.26	0.35	0.45	0.54
	160	100	120	120	0.13	0.18	0.25	0.33	0.42	0.50
	100	75	75		0.12	0.16	0.22	0.28	0.36	0.43
	60	40	50		0.09	0.12	0.15	0.19	0.24	0.28
	90	80	80		0.13	0.18	0.23	0.31	0.39	0.46
	80	70	70		0.11	0.15	0.19	0.25	0.31	0.36
	90	90	90		0.08	0.10	0.13	0.16	0.20	0.25
	25	25	25		0.04	0.05	0.07	0.09	0.11	0.14

The specified cutting values are guide values.

The optimum data for the respective machining task should be determined during the test or machining.





DEEP DRILLING

Deep drill

MICRO-Step-Drill-Steel	268
MICRO-Deep-Drill	269
MEGA-Deep-Drill	273
MEGA-Deep-Drill-Alu	278

Technical appendix

Cutting data recommendations	284
Application notes for deep drilling	742

MICRO-Step-Drill-Steel

Solid carbide step drill
SCD581, internal coolant supply

Design:

Drill diameter: 1.00 – 3.00 mm
Bore tolerance: IT 9 (achievable)
Cutting material: HP246
Number of cutting edges: 2
Number of guiding chamfers: 2
Tip angle: 142°

Application:

Spotting drill specifically designed for the MICRO-Deep-Drill.
Maximum use up to diameter of 3.00 mm.

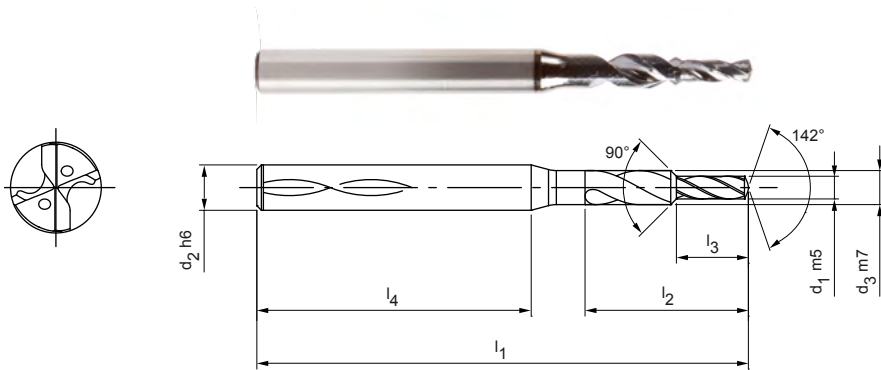

Stocked preferred series in shank form HA

Dimensions							Shank form HA	
d_1 m5	d_2 h6	d_3 m7	l_1	l_2	l_3	l_4	Specification	Order no.
1,00	3	1,5	50	7,2	3	38	SCD581-0100-2-2-142HA-HP246	31080870
1,10	3	1,65	50	7,9	3,3	37,5	SCD581-0110-2-2-142HA-HP246	31080871
1,20	3	1,8	50	8,6	3,6	36,9	SCD581-0120-2-2-142HA-HP246	31080872
1,30	3	1,95	50	9,4	3,9	36,3	SCD581-0130-2-2-142HA-HP246	31080873
1,40	3	2,1	50	10,1	4,2	35,7	SCD581-0140-2-2-142HA-HP246	31080874
1,50	3	2,25	50	10,8	4,5	35,1	SCD581-0150-2-2-142HA-HP246	31080875
1,60	3	2,4	50	11,5	4,8	34,6	SCD581-0160-2-2-142HA-HP246	31080876
1,70	3	2,55	50	12,2	5,1	34	SCD581-0170-2-2-142HA-HP246	31080877
1,80	3	2,7	50	13	5,4	33,4	SCD581-0180-2-2-142HA-HP246	31080878
1,90	4	2,85	55	13,7	5,7	35,9	SCD581-0190-2-2-142HA-HP246	31080879
2,00	4	3	55	14,4	6	35,3	SCD581-0200-2-2-142HA-HP246	31080880
2,10	4	3,15	55	15,1	6,3	34,8	SCD581-0210-2-2-142HA-HP246	31080881
2,20	4	3,3	55	15,8	6,6	34,2	SCD581-0220-2-2-142HA-HP246	31080882
2,30	4	3,45	55	16,6	6,9	33,6	SCD581-0230-2-2-142HA-HP246	31080883
2,40	4	3,6	55	17,3	7,2	33	SCD581-0240-2-2-142HA-HP246	31080884
2,50	4	3,75	55	18	7,5	32,4	SCD581-0250-2-2-142HA-HP246	31080885
2,60	6	3,9	66	18,7	7,8	39,1	SCD581-0260-2-2-142HA-HP246	31080886
2,70	6	4,05	66	19,4	8,1	38,5	SCD581-0270-2-2-142HA-HP246	31080887
2,80	6	4,2	66	20,2	8,4	37,9	SCD581-0280-2-2-142HA-HP246	31080888
2,90	6	4,35	66	20,9	8,7	37,4	SCD581-0290-2-2-142HA-HP246	31080889
3,00	6	4,5	66	21,6	9	36,8	SCD581-0300-2-2-142HA-HP246	31080890

Dimensions in mm.

For cutting data recommendations, see end of chapter.

Special designs and other coatings available upon request.

MICRO-Deep-Drill

Solid carbide twist drill
SCD171 (20xD), internal coolant supply

Design:

Drill diameter: 1.00 – 2.99 mm
Bore tolerance: \geq IT 9
Cutting material: HP246
Number of cutting edges: 2
Number of guiding chamfers: 4
Tip angle: 135°
Helix angle: 30°
Special features: Head coating

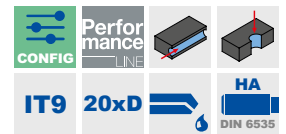
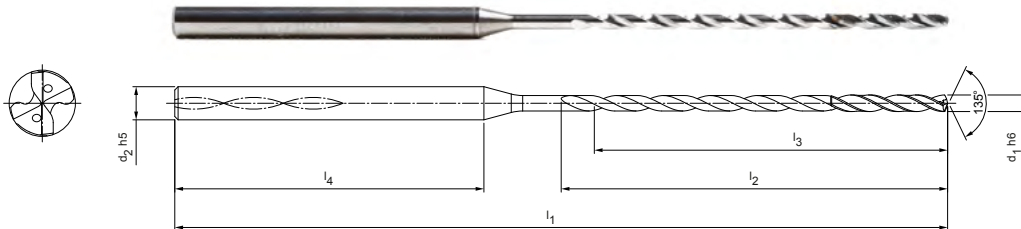

Stocked preferred series in shank form HA

Dimensions						L/d ratio	Shank form HA	
d ₁ h7	d ₂ h6	l ₁	l ₂	l ₃	l ₄		Specification	Order no.
1,00	3	62	27	25	28	28	SCD171-0100-2-4-135HA20-HP246	30998795
1,10	3	62	27	25	28	28	SCD171-0110-2-4-135HA20-HP246	30998796
1,20	3	62	27	25	28	28	SCD171-0120-2-4-135HA20-HP246	30998798
1,30	3	70	35	33	28	28	SCD171-0130-2-4-135HA20-HP246	30998799
1,40	3	70	35	33	28	28	SCD171-0140-2-4-135HA20-HP246	30998800
1,50	3	70	35	33	28	28	SCD171-0150-2-4-135HA20-HP246	30998801
1,60	3	75	41	38	28	28	SCD171-0160-2-4-135HA20-HP246	30998802
1,70	3	75	41	38	28	28	SCD171-0170-2-4-135HA20-HP246	30998803
1,80	3	75	41	38	28	28	SCD171-0180-2-4-135HA20-HP246	30998804
1,90	3	80	46	43	28	28	SCD171-0190-2-4-135HA20-HP246	30998805
2,00	3	80	46	43	28	28	SCD171-0200-2-4-135HA20-HP246	30998806
2,10	3	80	46	43	28	28	SCD171-0210-2-4-135HA20-HP246	30998807
2,20	3	90	55	51	28	28	SCD171-0220-2-4-135HA20-HP246	30998808
2,30	3	90	55	51	28	28	SCD171-0230-2-4-135HA20-HP246	30998809
2,40	3	90	55	51	28	28	SCD171-0240-2-4-135HA20-HP246	30998810
2,50	3	90	55	51	28	28	SCD171-0250-2-4-135HA20-HP246	30998811
2,60	3	100	66	62	28	28	SCD171-0260-2-4-135HA20-HP246	30998812
2,70	3	100	66	62	28	28	SCD171-0270-2-4-135HA20-HP246	30998813
2,80	3	100	66	62	28	28	SCD171-0280-2-4-135HA20-HP246	30998814
2,90	3	100	66	62	28	28	SCD171-0290-2-4-135HA20-HP246	30998815

Recommendation for spotting drill:

Please use the MICRO-Step-Drill (SCD581) or the MICRO-Drill-Steel (SCD371 - 5xD) with the same nominal diameter for the spotting drill.

The tip angle and diameter tolerances are matched for optimal functionality as well as for the interaction of spotting drill and deep drill.

Dimensions in mm.

For cutting data recommendations, see end of chapter.

Special designs and other coatings available upon request.

MEGA-Deep-Drill | Solid carbide twist drill SCD171 (20xD), internal coolant supply

Configurable features



Diameter:
Diameter in increments of
0.01 mm freely selectable

**Specification:**

SCD171-[diameter]-2-4-135HA20-HP246

Example:

SCD171-0221-2-4-135HA20-HP246

Tool diameter $d_1 = 2.21$ mm

Dimensions of configurable series

d_1 min.	d_1 max.	d_2 h6	l_1	l_2	l_3 max.	l_4
1,00	1,29	3	62	27	25	28
1,30	1,39	3	70	35	33	28
1,40	1,59	3	70	35	32	28
1,60	1,89	3	75	41	38	28
1,90	2,09	3	80	46	43	28
2,10	2,19	3	80	46	42	28
2,20	2,59	3	90	55	51	28
2,60	2,69	3	100	66	62	28
2,70	2,99	3	100	66	61	28

Application notes for deep drilling can be found in the Technical Appendix chapter.

Dimensions in mm.

For cutting data recommendations, see end of chapter.

Special designs and other coatings available upon request.

MICRO-Deep-Drill

Solid carbide twist drill
SCD171 (30xD), internal coolant supply

Design:

Drill diameter: 1.00 – 2.99 mm
Bore tolerance: \geq IT 9
Cutting material: HP246
Number of cutting edges: 2
Number of guiding chamfers: 4
Tip angle: 135°
Helix angle: 30°
Special features: Head coating

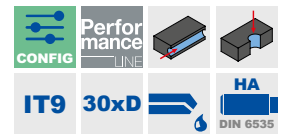
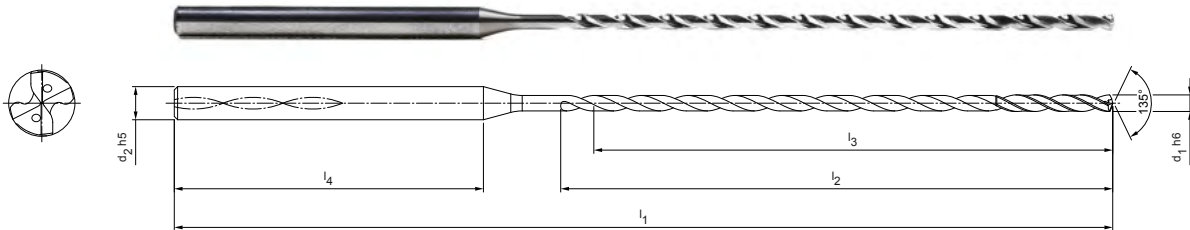

Stocked preferred series in shank form HA

Dimensions						L/d ratio	Shank form HA	
d_1 h6	d_2 h5	l_1	l_2	l_3	l_4		Specification	Order no.
1,00	3	75	38	36	28	36	SCD171-0100-2-4-135HA30-HP246	30998816
1,10	3	75	38	36	28	33	SCD171-0110-2-4-135HA30-HP246	30998817
1,20	3	75	38	36	28	30	SCD171-0120-2-4-135HA30-HP246	30998818
1,30	3	85	50	48	28	37	SCD171-0130-2-4-135HA30-HP246	30998819
1,40	3	85	50	48	28	34	SCD171-0140-2-4-135HA30-HP246	30998820
1,50	3	85	50	48	28	31	SCD171-0150-2-4-135HA30-HP246	30998821
1,60	3	95	59	56	28	35	SCD171-0160-2-4-135HA30-HP246	30998822
1,70	3	95	59	56	28	33	SCD171-0170-2-4-135HA30-HP246	30998823
1,80	3	95	59	56	28	31	SCD171-0180-2-4-135HA30-HP246	30998824
1,90	3	100	66	63	28	33	SCD171-0190-2-4-135HA30-HP246	30998825
2,00	3	100	66	63	28	32	SCD171-0200-2-4-135HA30-HP246	30998826
2,10	3	100	66	63	28	30	SCD171-0210-2-4-135HA30-HP246	30998827
2,20	3	115	80	76	28	35	SCD171-0220-2-4-135HA30-HP246	30998828
2,30	3	115	80	76	28	33	SCD171-0230-2-4-135HA30-HP246	30998829
2,40	3	115	80	76	28	32	SCD171-0240-2-4-135HA30-HP246	30998830
2,50	3	115	80	76	28	30	SCD171-0250-2-4-135HA30-HP246	30451572
2,60	3	130	96	92	28	35	SCD171-0260-2-4-135HA30-HP246	30998832
2,70	3	130	96	92	28	34	SCD171-0270-2-4-135HA30-HP246	30998833
2,80	3	130	96	92	28	33	SCD171-0280-2-4-135HA30-HP246	30998834
2,90	3	130	96	92	28	31	SCD171-0290-2-4-135HA30-HP246	30998835

Recommendation for spotting drill:

Please use the MICRO-Step-Drill (SCD581) or the MICRO-Drill-Steel (SCD371 - 5xD) with the same nominal diameter for the spotting drill.

The tip angle and diameter tolerances are matched for optimal functionality as well as for the interaction of spotting drill and deep drill.

Dimensions in mm.

For cutting data recommendations, see end of chapter.

Special designs and other coatings available upon request.

MEGA-Deep-Drill | Solid carbide twist drill SCD171 (20xD), internal coolant supply

Configurable features



Diameter:
Diameter in increments of
0.01 mm freely selectable

**Specification:**

SCD171-[diameter]-2-4-135HA30-HP246

Example:

SCD171-0221-2-4-135HA30-HP246

Tool diameter $d_1 = 2.21$ mm

Dimensions of configurable series

d_1 min.	d_1 max.	d_2 h6	l_1	l_2	l_3 max.	l_4
1,00	1,29	3	75	38	36	28
1,30	1,39	3	85	50	48	28
1,40	1,59	3	85	50	47	28
1,60	1,89	3	95	59	56	28
1,90	2,09	3	100	66	63	28
2,10	2,19	3	100	66	62	28
2,20	2,59	3	115	80	76	28
2,60	2,69	3	130	96	92	28
2,70	2,99	3	130	96	91	28

Dimensions in mm.

For cutting data recommendations, see end of chapter.

Special designs and other coatings available upon request.

MEGA-Deep-Drill

Solid carbide twist drill
SCD171 (15xD), internal coolant supply

Design:

Drill diameter: 3.00 – 15.00 mm
Bore tolerance: \geq IT 9
Cutting material: HP285 / HP245
Number of cutting edges: 2
Number of guiding chamfers: 4
Tip angle: 135°
Helix angle: 30°

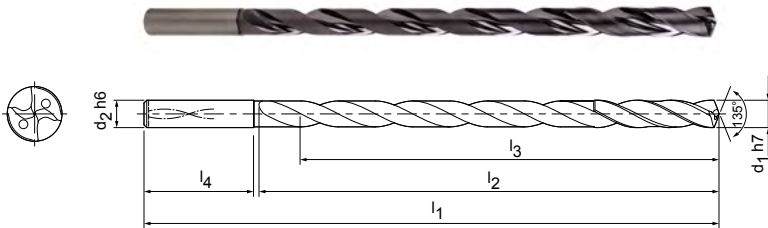

Stocked preferred series in shank form HA

Dimensions						L/d ratio	Shank form HA	
d ₁ h7	d ₂ h6	l ₁	l ₂	l ₃	l ₄		Specification	Order no.
3,00	4	90	56	52	32	17	SCD171-0300-2-4-135HA15-HP285	30392214
3,50	4	100	66	61	32	17	SCD171-0350-2-4-135HA15-HP285	30392215
4,00	4	100	66	60	32	15	SCD171-0400-2-4-135HA15-HP285	30392216
4,50	5	110	74	67	34	15	SCD171-0450-2-4-135HA15-HP285	30392217
5,00	5	120	84	77	34	15	SCD171-0500-2-4-135HA15-HP285	30392218
5,50	6	130	92	84	36	15	SCD171-0550-2-4-135HA15-HP285	30392219
6,00	6	140	102	93	36	16	SCD171-0600-2-4-135HA15-HP285	30392220
7,00	7	155	115	105	38	15	SCD171-0700-2-4-135HA15-HP285	30392221
8,00	8	175	133	121	40	15	SCD171-0800-2-4-135HA15-HP285	30392222
9,00	9	190	148	135	40	15	SCD171-0900-2-4-135HA15-HP285	30392223
9,50	10	210	168	153	40	15	SCD171-0950-2-4-135HA15-HP245	30453021
10,00	10	210	168	153	40	15	SCD171-1000-2-4-135HA15-HP285	30392224
11,00	11	230	183	167	45	15	SCD171-1100-2-4-135HA15-HP245	30392225
12,00	12	250	203	185	45	15	SCD171-1200-2-4-135HA15-HP245	30392226
13,00	13	265	218	199	45	15	SCD171-1300-2-4-135HA15-HP245	30392227
14,00	14	285	233	212	50	15	SCD171-1400-2-4-135HA15-HP245	30392228
15,00	15	305	253	231	50	15	SCD171-1500-2-4-135HA15-HP245	30392229

Recommendation for spotting drill:

Please use the MEGA-Drill-Steel-Plus (SCD601 - 3xD) and the same nominal diameter for the spotting drill. The tip angle and diameter tolerances are matched for optimal functionality as well as for the interaction of spotting drill and deep drill.

Application notes for deep drilling can be found in the Technical Appendix chapter.

Dimensions in mm.

For cutting data recommendations, see end of chapter.

Special designs and other coatings available upon request.

MEGA-Deep-Drill

Solid carbide twist drill
SCD171 (20xD), internal coolant supply

Design:
 Drill diameter: 3.00 – 16.00 mm
 Bore tolerance: \geq IT 9
 Cutting material: HP245 / HP285
 Number of cutting edges: 2
 Number of guiding chamfers: 4
 Tip angle: 135°
 Helix angle: 30°

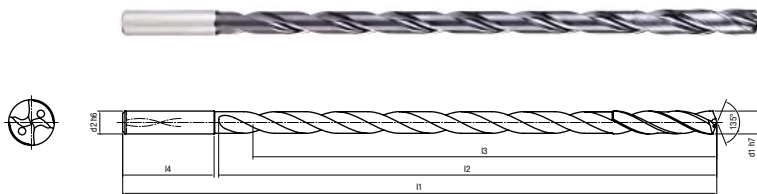

Stocked preferred series in shank form HA

Dimensions						L/d ratio	Shank form HA	
d ₁ h7	d ₂ h6	l ₁	l ₂	l ₃	l ₄		Specification	Order no.
3,00	4	110	74	70	32	23	SCD171-0300-2-4-135HA20-HP285	30392231
3,50	4	120	86	81	32	23	SCD171-0350-2-4-135HA20-HP285	30392232
4,00	4	120	86	80	32	20	SCD171-0400-2-4-135HA20-HP285	30392233
5,00	5	145	109	102	34	20	SCD171-0500-2-4-135HA20-HP285	30392235
5,50	6	160	120	112	36	20	SCD171-0550-2-4-135HA20-HP285	30392236
6,00	6	170	130	121	36	20	SCD171-0600-2-4-135HA20-HP285	30392237
6,50	7	190	150	140	36	20	SCD171-0650-2-4-135HA20-HP245	30451508
7,00	7	190	150	140	38	20	SCD171-0700-2-4-135HA20-HP285	30392238
8,00	8	215	173	161	40	20	SCD171-0800-2-4-135HA20-HP285	30392239
9,00	9	240	196	183	40	20	SCD171-0900-2-4-135HA20-HP285	30392240
10,00	10	260	218	203	40	20	SCD171-1000-2-4-135HA20-HP285	30392241
11,00	11	285	238	222	45	20	SCD171-1100-2-4-135HA20-HP245	30392242
12,00	12	305	258	240	45	20	SCD171-1200-2-4-135HA20-HP245	30392243
14,00	14	355	303	282	50	20	SCD171-1400-2-4-135HA20-HP245	30392245
15,00	15	375	323	301	50	20	SCD171-1500-2-4-135HA20-HP245	30392246
16,00	16	400	348	324	50	20	SCD171-1600-2-4-135HA20-HP245	30392247

Recommendation for spotting drill:

Please use the MEGA-Drill-Steel-Plus (SCD601 - 3xD) and the same nominal diameter for the spotting drill. The tip angle and diameter tolerances are matched for optimal functionality as well as for the interaction of spotting drill and deep drill.

Application notes for deep drilling can be found in the Technical Appendix chapter.

MEGA-Deep-Drill

Solid carbide twist drill
SCD171 (25xD), internal coolant supply

Design:

Drill diameter: 3.00 – 14.00 mm
Bore tolerance: \geq IT 9
Cutting material: HP285 / HP245
Number of cutting edges: 2
Number of guiding chamfers: 4
Tip angle: 135°
Helix angle: 30°

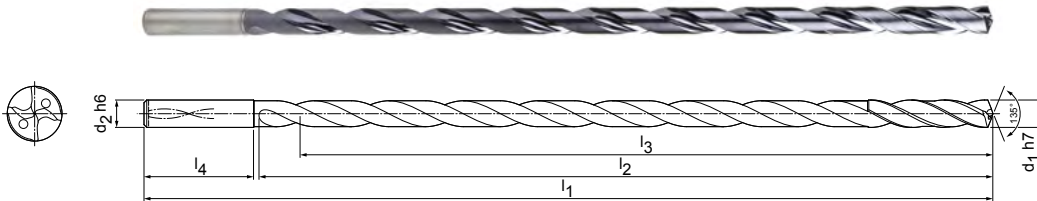

Stocked preferred series in shank form HA

Dimensions						L/d ratio	Shank form HA	
d ₁ h7	d ₂ h6	l ₁	l ₂	l ₃	l ₄		Specification	Order no.
3,00	4	125	91	87	32	29	SCD171-0300-2-4-135HA25-HP285	30392248
3,50	4	140	106	101	32	29	SCD171-0350-2-4-135HA25-HP285	30392249
4,00	4	140	106	100	32	25	SCD171-0400-2-4-135HA25-HP285	30392250
5,00	5	170	134	127	34	25	SCD171-0500-2-4-135HA25-HP285	30392252
5,50	6	185	147	139	36	25	SCD171-0550-2-4-135HA25-HP285	30392253
6,00	6	200	160	151	36	25	SCD171-0600-2-4-135HA25-HP285	30392254
7,00	7	225	185	175	38	25	SCD171-0700-2-4-135HA25-HP285	30392255
8,00	8	255	213	201	40	25	SCD171-0800-2-4-135HA25-HP285	30392256
9,00	9	280	238	225	40	25	SCD171-0900-2-4-135HA25-HP285	30392257
10,00	10	310	268	253	40	25	SCD171-1000-2-4-135HA25-HP285	30392258
11,00	11	340	293	277	45	25	SCD171-1100-2-4-135HA25-HP245	30392259
12,00	12	365	318	300	45	25	SCD171-1200-2-4-135HA25-HP245	30392260
14,00	14	425	373	352	50	25	SCD171-1400-2-4-135HA25-HP245	30392262

Recommendation for spotting drill:

Please use the MEGA-Drill-Steel-Plus (SCD601 - 3xD) and the same nominal diameter for the spotting drill. The tip angle and diameter tolerances are matched for optimal functionality as well as for the interaction of spotting drill and deep drill.

Application notes for deep drilling can be found in the Technical Appendix chapter.

Dimensions in mm.

For cutting data recommendations, see end of chapter.

Special designs and other coatings available upon request.

MEGA-Deep-Drill

Solid carbide twist drill
SCD171 (30xD), internal coolant supply

Design:

Drill diameter: 3.00 – 12.00 mm
Bore tolerance: \geq IT 9
Cutting material: HP245 / HP285
Number of cutting edges: 2
Number of guiding chamfers: 4
Tip angle: 135°
Helix angle: 30°

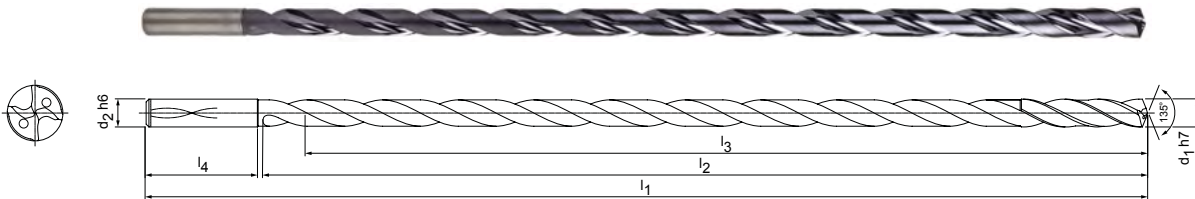

Stocked preferred series in shank form HA

Dimensions						L/d ratio	Shank form HA	
d ₁ h7	d ₂ h6	l ₁	l ₂	l ₃	l ₄		Specification	Order no.
3,00	4	145	110	106	32	35	SCD171-0300-2-4-135HA30-HP285	30392264
4,00	4	160	126	120	32	30	SCD171-0400-2-4-135HA30-HP285	30392266
4,50	5	180	144	137	34	31	SCD171-0450-2-4-135HA30-HP285	30392267
5,00	5	195	159	152	34	30	SCD171-0500-2-4-135HA30-HP285	30392268
5,50	6	210	172	164	36	30	SCD171-0550-2-4-135HA30-HP285	30392269
6,00	6	230	192	183	36	31	SCD171-0600-2-4-135HA30-HP285	30392270
7,00	7	260	220	210	38	30	SCD171-0700-2-4-135HA30-HP285	30392271
8,00	8	295	253	241	40	30	SCD171-0800-2-4-135HA30-HP285	30392272
9,00	9	325	283	270	40	30	SCD171-0900-2-4-135HA30-HP285	30392273
10,00	10	360	318	303	40	30	SCD171-1000-2-4-135HA30-HP285	30392274
11,00	11	400	353	337	45	31	SCD171-1100-2-4-135HA30-HP245	30392275
12,00	12	430	383	365	45	30	SCD171-1200-2-4-135HA30-HP245	30392276

Recommendation for spotting drill:

Please use the MEGA-Drill-Steel-Plus (SCD601 - 3xD) and the same nominal diameter for the spotting drill. The tip angle and diameter tolerances are matched for optimal functionality as well as for the interaction of spotting drill and deep drill.

Application notes for deep drilling can be found in the Technical Appendix chapter.

Dimensions in mm.
For cutting data recommendations, see end of chapter.
Special designs and other coatings available upon request.

MEGA-Deep-Drill

Solid carbide twist drill
SCD171 (40xD), internal coolant supply

Design:

Drill diameter: 4.00 – 6.00 mm
Bore tolerance: \geq IT 9
Cutting material: HP285
Number of cutting edges: 2
Number of guiding chamfers: 4
Tip angle: 130°
Helix angle: 30°

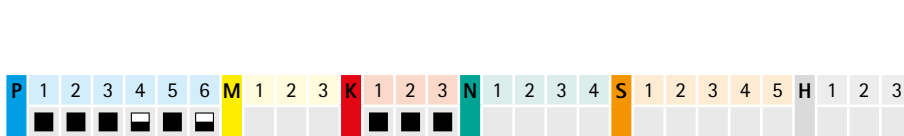
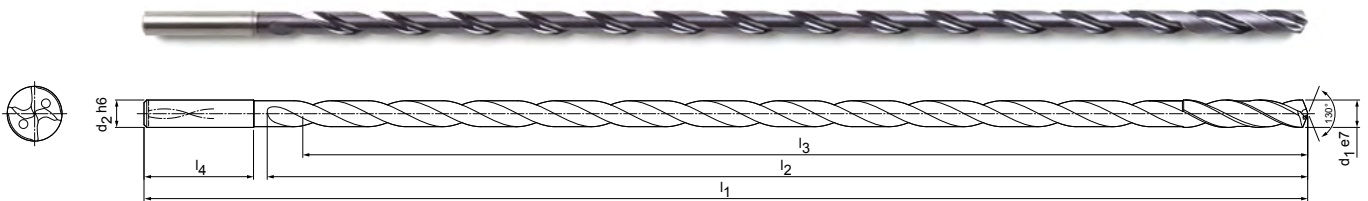

Stocked preferred series in shank form HA

Dimensions						L/d ratio	Shank form HA	
d ₁ e7	d ₂ h6	l ₁	l ₂	l ₃	l ₄		Specification	Order no.
4,00	4	205	170	164	32	43	SCD171-0400-2-4-130HA40-HP285	30549867
5,00	5	245	208	201	34	42	SCD171-0500-2-4-130HA40-HP285	30549869
6,00	6	290	250	241	36	42	SCD171-0600-2-4-130HA40-HP285	30549871

Recommendation for spotting drills or pre-drills:

Please use the MEGA-Drill-Steel-Plus (SCD601 - 3xD) and the same nominal diameter for the spotting drill. Then start pre-drilling using the MEGA-Deep-Drill SCD171 / 20xD and also using the same nominal diameter. The tip angle and diameter tolerance are matched for optimal functionality as well as for the interaction of spotting drill and deep drill.

Application notes for deep drilling can be found in the Technical Appendix chapter.

Dimensions in mm.

For cutting data recommendations, see end of chapter.

Special designs and other coatings available upon request.



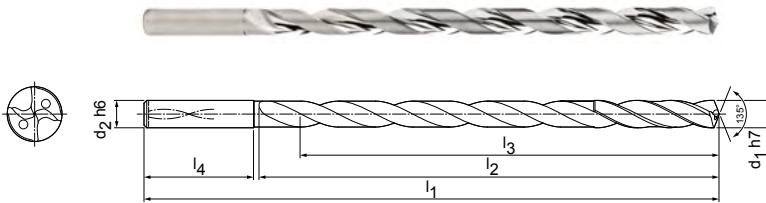

MEGA-Deep-Drill-Alu

Solid carbide twist drill
SCD181 (15xD), internal coolant supply

Design:
 Drill diameter: 3.00 – 12.00 mm
 Bore tolerance: \geq IT 9
 Cutting material: HU680 / HU644
 Number of cutting edges: 2
 Number of guiding chamfers: 4
 Tip angle: 135°
 Helix angle: 30°



P
1
2
3
4
5
6
M
1
2
3
K
1
2
3
N
1
2
3
4
S
1
2
3
4
5
H
1
2
3

Stocked preferred series in shank form HA

Dimensions						L/d ratio	Shank form HA	
d ₁ h7	d ₂ h6	l ₁	l ₂	l ₃	l ₄		Specification	Order no.
3,00	4	90	56	52	32	17	SCD181-0300-2-4-135HA15-HU680	30392277
3,50	4	100	66	61	32	17	SCD181-0350-2-4-135HA15-HU680	30392278
4,00	4	100	66	60	32	15	SCD181-0400-2-4-135HA15-HU680	30392279
5,00	5	120	84	77	34	15	SCD181-0500-2-4-135HA15-HU680	30392281
6,00	6	140	102	93	36	16	SCD181-0600-2-4-135HA15-HU680	30392283
7,00	7	155	115	105	38	15	SCD181-0700-2-4-135HA15-HU680	30392284
8,00	8	175	133	121	40	15	SCD181-0800-2-4-135HA15-HU680	30392285
10,00	10	210	168	153	40	15	SCD181-1000-2-4-135HA15-HU680	30392287
12,00	12	250	203	185	45	15	SCD181-1200-2-4-135HA15-HU644	30392289

Recommendation for spotting drill:

For the spotting drill please use the MEGA-Drill-Alu (SCD131 - 3xD/5xD) with the same nominal diameter. The tip angle and diameter tolerances are matched for optimal functionality as well as for the interaction of spotting drill and deep drill.

Application notes for deep drilling can be found in the Technical Appendix chapter.

Dimensions in mm.
 For cutting data recommendations, see end of chapter.
 Special designs and other coatings available upon request.

MEGA-Deep-Drill-Alu

Solid carbide twist drill
SCD181 (20xD), internal coolant supply

Design:

Drill diameter: 3.00 – 12.00 mm
Bore tolerance: \geq IT 9
Cutting material: HU680 / HU644
Number of cutting edges: 2
Number of guiding chamfers: 4
Tip angle: 135°
Helix angle: 30°

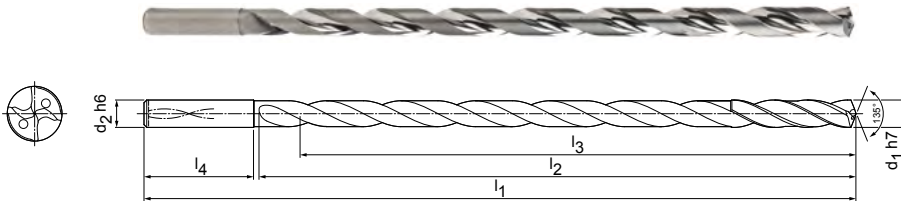

Stocked preferred series in shank form HA

Dimensions						L/d ratio	Shank form HA	
d ₁ h7	d ₂ h6	l ₁	l ₂	l ₃	l ₄		Specification	Order no.
3,00	4	110	74	70	32	23	SCD181-0300-2-4-135HA20-HU680	30392294
4,00	4	120	86	80	32	20	SCD181-0400-2-4-135HA20-HU680	30392296
5,00	5	145	109	102	34	20	SCD181-0500-2-4-135HA20-HU680	30392298
5,50	6	160	120	112	36	20	SCD181-0550-2-4-135HA20-HU680	30392299
6,00	6	170	130	121	36	20	SCD181-0600-2-4-135HA20-HU680	30392300
7,00	7	190	150	140	38	20	SCD181-0700-2-4-135HA20-HU680	30392301
8,00	8	215	173	161	40	20	SCD181-0800-2-4-135HA20-HU680	30392302
10,00	10	260	218	203	40	20	SCD181-1000-2-4-135HA20-HU680	30392304
12,00	12	305	258	240	45	20	SCD181-1200-2-4-135HA20-HU644	30392306

Recommendation for spotting drill:

For the spotting drill please use the MEGA-Drill-Alu (SCD131 - 3xD/5xD) with the same nominal diameter. The tip angle and diameter tolerances are matched for optimal functionality as well as for the interaction of spotting drill and deep drill.

Application notes for deep drilling can be found in the Technical Appendix chapter.

Dimensions in mm.

For cutting data recommendations, see end of chapter.

Special designs and other coatings available upon request.

MEGA-Deep-Drill-Alu

Solid carbide twist drill
SCD181 (25xD), internal coolant supply

Design:

Drill diameter: 3.00 – 10.00 mm
Bore tolerance: $\geq IT 9$
Cutting material: HU680
Number of cutting edges: 2
Number of guiding chamfers: 4
Tip angle: 135°
Helix angle: 30°

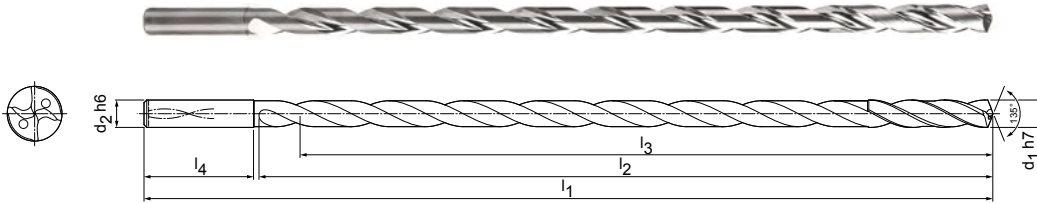

Stocked preferred series in shank form HA

Dimensions						L/d ratio	Shank form HA	
d ₁ h7	d ₂ h6	l ₁	l ₂	l ₃	l ₄		Specification	Order no.
3,00	4	125	91	87	32	29	SCD181-0300-2-4-135HA25-HU680	30392311
4,00	4	140	106	100	32	25	SCD181-0400-2-4-135HA25-HU680	30392313
5,00	5	170	134	127	34	25	SCD181-0500-2-4-135HA25-HU680	30392315
6,00	6	200	160	151	36	25	SCD181-0600-2-4-135HA25-HU680	30392317
7,00	7	225	185	175	38	25	SCD181-0700-2-4-135HA25-HU680	30392318
8,00	8	255	213	201	40	25	SCD181-0800-2-4-135HA25-HU680	30392319
10,00	10	310	268	253	40	25	SCD181-1000-2-4-135HA25-HU680	30392321

Recommendation for spotting drill:

For the spotting drill please use the MEGA-Drill-Alu (SCD131 - 3xD/5xD) with the same nominal diameter. The tip angle and diameter tolerances are matched for optimal functionality as well as for the interaction of spotting drill and deep drill.

Application notes for deep drilling can be found in the Technical Appendix chapter.

Dimensions in mm.
For cutting data recommendations, see end of chapter.
Special designs and other coatings available upon request.

MEGA-Deep-Drill-Alu

Solid carbide twist drill
SCD181 (30xD), internal coolant supply

Design:

Drill diameter: 4.00 - 6.00 mm
Bore tolerance: \geq IT 9
Cutting material: HU680
Number of cutting edges: 2
Number of guiding chamfers: 4
Tip angle: 135°
Helix angle: 30°

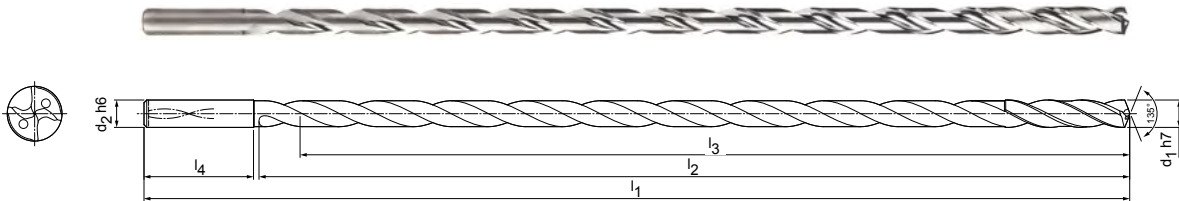

Stocked preferred series in shank form HA

Dimensions						L/d ratio	Shank form HA	
d ₁ h7	d ₂ h6	l ₁	l ₂	l ₃	l ₄		Specification	Order no.
4,00	4	160	126	120	32	30	SCD181-0400-2-4-135HA30-HU680	30392328
4,50	5	180	144	137	34	31	SCD181-0450-2-4-135HA30-HU680	30392329
5,00	5	195	159	152	34	30	SCD181-0500-2-4-135HA30-HU680	30392330
6,00	6	230	192	183	36	31	SCD181-0600-2-4-135HA30-HU680	30392332

Recommendation for spotting drill:

For the spotting drill please use the MEGA-Drill-Alu (SCD131 - 3xD/5xD) with the same nominal diameter. The tip angle and diameter tolerances are matched for optimal functionality as well as for the interaction of spotting drill and deep drill.

Application notes for deep drilling can be found in the Technical Appendix chapter.

Dimensions in mm.

For cutting data recommendations, see end of chapter.

Special designs and other coatings available upon request.



MEGA-Deep-Drill-Alu

Solid carbide twist drill
SCD181 (40xD), internal coolant supply

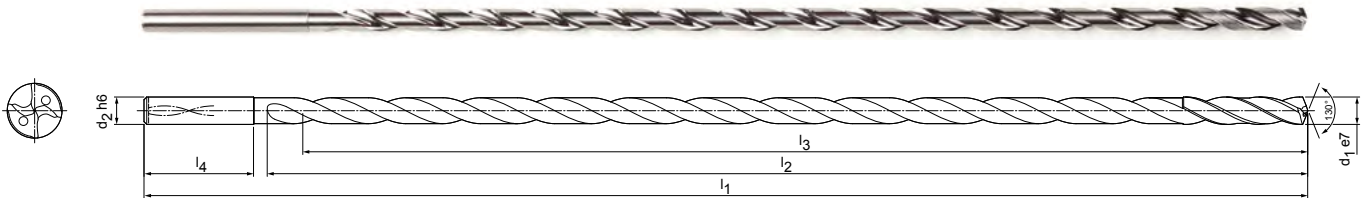
Design:
 Drill diameter: 6.00 - 7.00 mm
 Bore tolerance: $\geq IT 9$
 Cutting material: HU680
 Number of cutting edges: 2
 Number of guiding chamfers: 4
 Tip angle: 130°
 Helix angle: 30°



P
1
2
3
4
5
6
M
1
2
3
K
1
2
3
N
1
2
3
4
S
1
2
3
4
5
H
1
2
3

Stocked preferred series in shank form HA

Dimensions						L/d ratio	Shank form HA	
d ₁ h7	d ₂ h6	l ₁	l ₂	l ₃	l ₄		Specification	Order no.
6,00	6	290	250	241	36	42	SCD181-0600-2-4-130HA40-HU680	30549881
7,00	7	330	290	280	38	41	SCD181-0700-2-4-130HA40-HU680	30549882

Recommendation for spotting drill:

For the spotting drill please use the MEGA-Drill-Alu (SCD131 - 3xD/5xD) with the same nominal diameter. The tip angle and diameter tolerances are matched for optimal functionality as well as for the interaction of spotting drill and deep drill.

Application notes for deep drilling can be found in the Technical Appendix chapter.

Dimensions in mm.
 For cutting data recommendations, see end of chapter.
 Special designs and other coatings available upon request.



Cutting data recommendations for deep drills

Feed and cutting speed

MICRO-Step-Drill | SCD581

MMG*		Workpiece material	Strength/hardness [N/mm ²] [HRC]
P	P1	P1.1 Structural, free-cutting, case hardened and heat-treated steels, non-alloy	< 700
		P1.2 Structural, free-cutting, case hardened and heat-treated steels, non-alloy	< 1,200
	P2	P2.1 Nitrided, case hardened and heat-treated steels, alloy	< 900
		P2.2 Nitrided, case hardened and heat-treated steels, alloy	< 1,400
	P3	P3.1 Tool, bearing, spring and high-speed steels**	< 800
		P3.2 Tool, bearing, spring and high-speed steels**	< 1,000
		P3.3 Tool, bearing, spring and high-speed steels**	< 1,500
	P5	P5.1 Cast steel	
M	M1	M1.1 Stainless steels, austenitic	< 700
		M1.2 Stainless steels, ferritic/austenitic (duplex)	< 1,000
K	K1	K1.1 Cast iron with lamellar graphite (grey cast iron), GJL	< 300
		K2.1 Cast iron with spheroidal graphite, GJS	< 500
	K2	K2.2 Cast iron with spheroidal graphite, GJS	≤ 800
		K2.3 Cast iron with spheroidal graphite, GJS	> 800
	K3	K3.1 Cast iron with spheroidal graphite, GJV; malleable cast iron, GJM	< 500
		K3.2 Cast iron with spheroidal graphite, GJV; malleable cast iron, GJM	> 500

* MAPAL machining groups

** If the alloy parts Cr, Mo, Ni, V, W in total > 8% then select the next highest MAPAL machining group.

	Cutting speed v_c [m/min]				Feed f [mm] for drill diameter					
	Internal cooling	External cooling	MQL	Air	1.00	1.20	1.60	1.90	2.40	3.00
	80	70	70		0.05	0.06	0.06	0.07	0.08	0.09
	70	60	60		0.07	0.07	0.08	0.09	0.10	0.11
	80	70	70		0.06	0.07	0.08	0.08	0.10	0.11
	55	50	50		0.06	0.06	0.07	0.07	0.08	0.09
	60	50	50		0.06	0.06	0.07	0.07	0.08	0.10
	50	45	45		0.05	0.05	0.06	0.07	0.07	0.08
	50	35	40		0.05	0.05	0.05	0.06	0.06	0.07
	80	70	70		0.06	0.07	0.08	0.08	0.10	0.11
	45	30	30		0.04	0.04	0.05	0.05	0.06	0.06
	95	70	70	70	0.06	0.07	0.08	0.09	0.10	0.12
	130	80	95	95	0.07	0.07	0.08	0.09	0.11	0.13
	80	60	60		0.06	0.07	0.08	0.09	0.10	0.11
	70	65	65		0.07	0.08	0.08	0.09	0.11	0.12
	65	55	55		0.06	0.07	0.08	0.08	0.09	0.11

The specified cutting values are guide values.

The optimum data for the respective machining task should be determined during the test or machining.

Cutting data recommendations for deep drills

Feed and cutting speed

MICRO-Deep-Drill | SCD171

MMG*	Workpiece material		Strength/hardness [N/mm ²] [HRC]
P	P1	P1.1 Structural, free-cutting, case hardened and heat-treated steels, non-alloy	< 700
		P1.2 Structural, free-cutting, case hardened and heat-treated steels, non-alloy	< 1,200
	P2	P2.1 Nitrided, case hardened and heat-treated steels, alloy	< 900
		P2.2 Nitrided, case hardened and heat-treated steels, alloy	< 1,400
	P3	P3.1 Tool, bearing, spring and high-speed steels**	< 800
		P3.2 Tool, bearing, spring and high-speed steels**	< 1,000
		P3.3 Tool, bearing, spring and high-speed steels**	< 1,500
	P5	P5.1 Cast steel	
K	K1	K1.1 Cast iron with lamellar graphite (grey cast iron), GJL	< 300
		K2.1 Cast iron with spheroidal graphite, GJS	< 500
	K2	K2.2 Cast iron with spheroidal graphite, GJS	≤ 800
		K2.3 Cast iron with spheroidal graphite, GJS	> 800
	K3	K3.1 Cast iron with spheroidal graphite, GJV; malleable cast iron, GJM	< 500
		K3.2 Cast iron with spheroidal graphite, GJV; malleable cast iron, GJM	> 500

MEGA-Deep-Drill-Alu | SCD181

MMG*	Workpiece material		Strength/hardness [N/mm ²] [HRC]
N	N1	N1.1 Aluminium, non-alloy and alloy < 3 % Si	
		N1.2 Aluminium, alloy ≤ 7 % Si	
		N1.3 Aluminium, alloy > 7-12 % Si	
		N1.4 Aluminium, alloy > 12 % Si	
	N2	N2.1 Copper, non-alloy and low-alloy	< 300
		N2.2 Copper, alloy	> 300
		N2.3 Brass, bronze, gunmetal	< 1,200

* MAPAL machining groups

** If the alloy parts Cr, Mo, Ni, V, W in total > 8% then select the next highest MAPAL machining group.

	Cutting speed v_c [m/min]			Feed f [mm] for drill diameter					
	Internal cooling	MQL	Air	1.00	2.00	4.00	6.00	9.00	16.00
	90	80		0.04	0.06	0.09	0.13	0.19	0.27
	80	70		0.06	0.08	0.11	0.16	0.24	0.34
	90	75		0.05	0.07	0.10	0.16	0.23	0.32
	65	55		0.05	0.07	0.09	0.13	0.18	0.25
	70	60		0.05	0.06	0.09	0.14	0.21	0.29
	55	50		0.04	0.06	0.08	0.12	0.17	0.23
	55	45		0.04	0.05	0.07	0.09	0.13	0.18
	90	75		0.05	0.07	0.10	0.16	0.23	0.32
	110	75	75	0.14	0.18	0.25	0.32	0.41	0.53
	145	110	110	0.14	0.18	0.24	0.30	0.38	0.49
	90	70		0.13	0.16	0.21	0.26	0.33	0.42
	55	45		0.10	0.12	0.14	0.18	0.22	0.28
	80	70		0.14	0.18	0.22	0.28	0.36	0.46
	70	65		0.12	0.15	0.18	0.23	0.29	0.36

	Cutting speed v_c [m/min]			Feed f [mm] for drill diameter					
	Internal cooling	MQL	Air	3.00	4.00	5.50	7.50	10.50	16.00
	300	250		0.11	0.13	0.16	0.20	0.25	0.32
	250	200		0.13	0.16	0.21	0.26	0.33	0.42
	220	180		0.13	0.16	0.21	0.26	0.33	0.42
	180	150		0.13	0.16	0.21	0.26	0.33	0.42
	140			0.09	0.11	0.14	0.17	0.21	0.27
	120			0.11	0.14	0.17	0.22	0.28	0.35
	200	160	120	0.14	0.18	0.25	0.32	0.41	0.53

The specified cutting values are guide values.

The optimum data for the respective machining task should be determined during the test or machining.



DRILL REAMING

Drill reamers

Technology _____ 290

Tritan-Drill-Reamer _____ 292

Technical appendix

Cutting data recommendations _____ 298

TRITAN DRILL REAMER

The most precise solution for drilling and reaming in one machining step

A proven way to manufacture as economical-ly as possible is combining several machining steps in one tool. For example, bores can be drilled and reamed simultaneously with the Tritan-Drill-Reamer from MAPAL.

MAPAL has developed the Tritan-Drill-Reamer in order to produce fitting bores even more accurately using just one tool.

With six guiding chamfers for excellent guiding properties, precision-ground chip flutes with matching groove shape for good chip removal and a self-centring chisel edge, the new Tritan-Drill-Reamer is impressive all around.

The self-centring chisel edge ensures good positioning accuracy and improved spot drilling behaviour. Three cutting edges guarantee optimal roundness of the fit bore and highest performance. The guiding chamfers produce best-quality surfaces.

FEATURES

- Combination of drilling and reaming
- Length versions 3xD and 5xD
- Three cutting edges and six guiding chamfers
- With internal cooling
- Tolerance versions ± 0.003 mm and H7

ADVANTAGES

- Reduced productive and non-productive times
- Best performance and highest levels of accuracy
- High degree of positional accuracy
- Optimal roundness

Tool features in detail

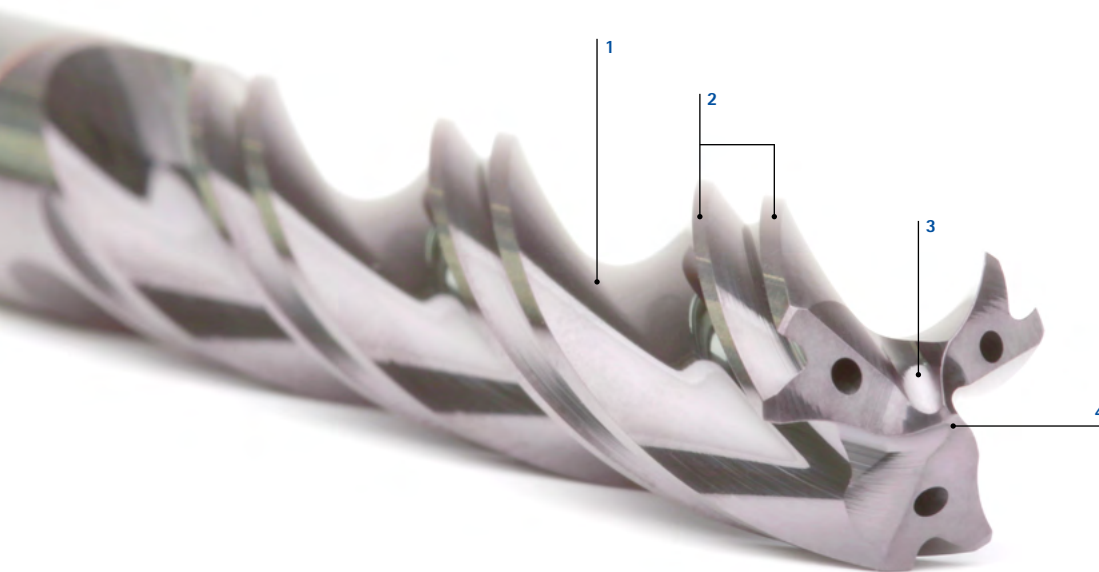

1 Finely ground groove profile

2 Six guiding chamfers

3 Innovative point thinning

4 Self-centring chisel edge



Six guiding chamfers

- For excellent guiding properties
- For the production of fitting bores with maximum economic efficiency and accuracy with only one tool



Innovative centre point

- Self-centring chisel edges for very good positional accuracy and improved spot drilling

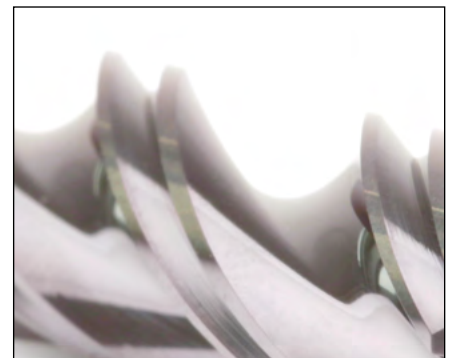

Finely ground groove profile

- Finely ground chip flutes with adapted groove shape for very good chip removal



Comparison Tritan-Drill-Reamer and double edged solution

Diameter deviation over the tools entire diameter (42CrMoS4)

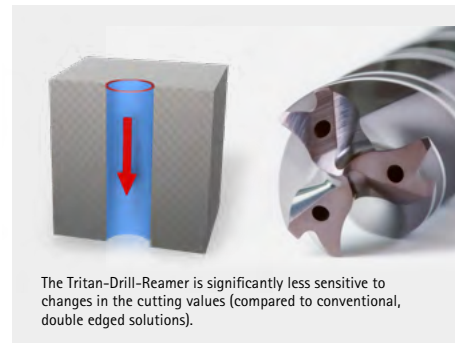
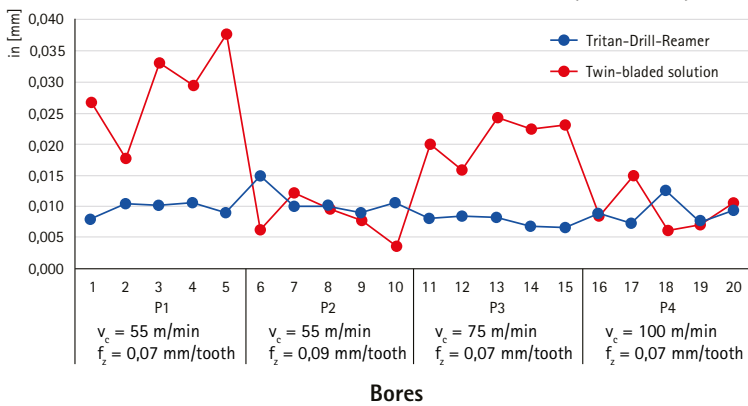

Circularity after 600 bores

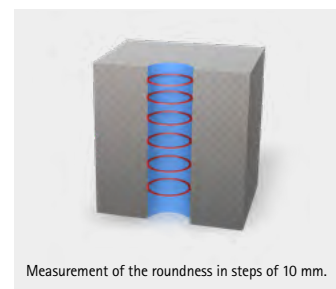
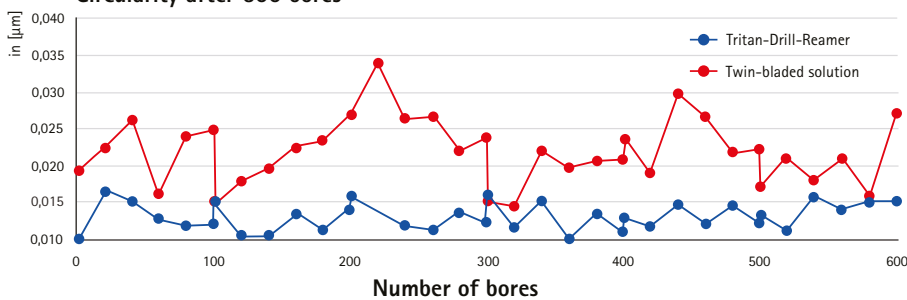

Tritan-Drill-Reamer

Drill reamer
SDR301G (3xD), internal coolant supply

Design:
 Drill diameter: 3.80 – 20.05 mm
 Bore tolerance: \geq IT 7
 Cutting material: HP358
 Number of cutting edges: 3
 Number of guiding chamfers: 6
 Tip angle: 140°
 Side rake angle: 30°

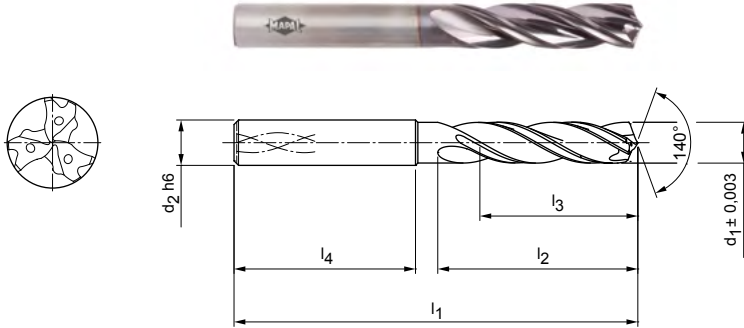

Stocked preferred series in shank form HA

Dimensions						Shank form HA	
$d_1 \pm 0.003$	$d_2 h6$	l_1	l_2	l_3	l_4	Specification	Order no.
3,99	6	66	24	17	36	SDR301G-3.990+3-3-HA03-HP358	31196569
4,00	6	66	24	17	36	SDR301G-4.000+3-3-HA03-HP358	31196570
4,01	6	66	24	17	36	SDR301G-4.010+3-3-HA03-HP358	31196571
4,99	6	66	28	20	36	SDR301G-4.990+3-3-HA03-HP358	31196575
5,00	6	66	28	20	36	SDR301G-5.000+3-3-HA03-HP358	31196576
5,01	6	66	28	20	36	SDR301G-5.010+3-3-HA03-HP358	31196577
5,02	6	66	28	20	36	SDR301G-5.020+3-3-HA03-HP358	31196578
5,99	6	66	28	20	36	SDR301G-5.990+3-3-HA03-HP358	31196581
6,00	6	66	28	20	36	SDR301G-6.000+3-3-HA03-HP358	31196582
6,01	6	66	28	20	36	SDR301G-6.010+3-3-HA03-HP358	31196583
7,99	8	79	41	29	36	SDR301G-7.990+3-3-HA03-HP358	31196587
8,00	8	79	41	29	36	SDR301G-8.000+3-3-HA03-HP358	31196588
8,01	8	79	41	29	36	SDR301G-8.010+3-3-HA03-HP358	31196589
9,99	10	89	47	35	40	SDR301G-9.990+3-3-HA03-HP358	31196593
10,00	10	89	47	35	40	SDR301G-10.000+3-3-HA03-HP358	31196594
10,01	10	89	47	35	40	SDR301G-10.010+3-3-HA03-HP358	31196595
10,02	10	89	47	35	40	SDR301G-10.020+3-3-HA03-HP358	31196596
11,99	12	102	55	40	45	SDR301G-11.990+3-3-HA03-HP358	31196599
12,00	12	102	55	40	45	SDR301G-12.000+3-3-HA03-HP358	31196600
12,01	12	102	55	40	45	SDR301G-12.010+3-3-HA03-HP358	31196601
13,99	14	107	60	43	45	SDR301G-13.990+3-3-HA03-HP358	31196605
14,00	14	107	60	43	45	SDR301G-14.000+3-3-HA03-HP358	31196606
14,01	14	107	60	43	45	SDR301G-14.010+3-3-HA03-HP358	31196607
15,99	16	115	65	45	48	SDR301G-15.990+3-3-HA03-HP358	31196611
16,00	16	115	65	45	48	SDR301G-16.000+3-3-HA03-HP358	31196612
16,01	16	115	65	45	48	SDR301G-16.010+3-3-HA03-HP358	31196613

Tritan-Drill-Reamer | Drill reamer SDR301G (3xD), internal coolant supply

Configurable features



Diameter:
Diameter in increments of
0.001 mm freely selectable

**Specification:**

SDR301G-[diameter]+3-3-HA03-HP358

Example:

SDR301G-4.001+3-3-HA03-HP358

Tool diameter $d_1 = 4.001$ mm

Dimensions of configurable series

d_1 min.	d_1 max.	d_2 h6	l_1	l_2	l_3	l_4
3,800	4,700	6	66	24	17	36
4,701	6,050	6	66	28	20	36
6,051	8,050	8	79	41	29	36
8,051	10,050	10	89	47	35	40
10,051	12,050	12	102	55	40	45
12,970	14,050	14	107	60	43	45
14,970	16,050	16	115	65	45	48
16,800	18,050	18	123	73	51	48
18,700	20,050	20	131	79	55	50

Dimensions in mm.

For tolerance class fit bores up to max. IT7, with sufficient machine stability and cooling.

For help in calculating the optimum nominal diameter for different fitting bores, please refer to the information field at the end of the chapter.

For cutting data recommendations, see end of chapter.

Special designs and other coatings available upon request.

Tritan-Drill-Reamer

Drill reamer
SDR301 (3xD), internal coolant supply

Design:
 Drill diameter: 4.00 – 16.00 mm
 Bore tolerance: \geq IT 7
 Cutting material: HP358
 Number of cutting edges: 3
 Number of guiding chamfers: 6
 Tip angle: 140°
 Side rake angle: 30°

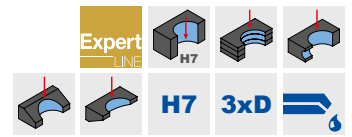
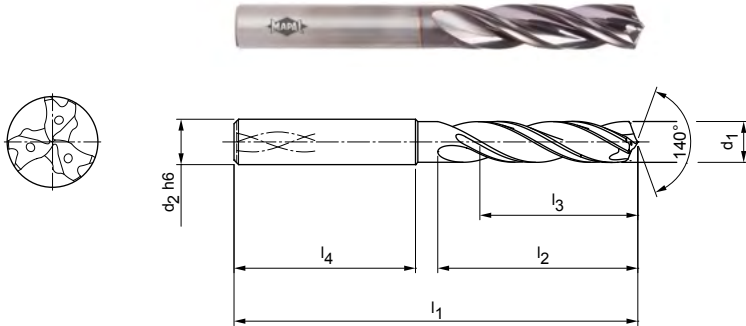

Stocked preferred series in shank form HA

Dimensions						Shank form HA	
d ₁ H7	d ₂ h6	l ₁	l ₂	l ₃	l ₄	Specification	Order no.
4,00	6	66	24	17	36	SDR301-4.000H7-HA03-HP358	31196337
5,00	6	66	28	20	36	SDR301-5.000H7-HA03-HP358	31196338
6,00	6	66	28	20	36	SDR301-6.000H7-HA03-HP358	31196339
8,00	8	79	41	29	36	SDR301-8.000H7-HA03-HP358	31196560
10,00	10	89	47	35	40	SDR301-10.000H7-HA03-HP358	31196561
12,00	12	102	55	40	45	SDR301-12.000H7-HA03-HP358	31196562
14,00	14	107	60	43	45	SDR301-14.000H7-HA03-HP358	31196563
16,00	16	115	65	45	48	SDR301-16.000H7-HA03-HP358	31196564

Dimensions in mm.
 For tolerance class fit bores of H7, with sufficient machine stability and cooling.
 For cutting data recommendations, see end of chapter.
 Special designs and other coatings available upon request.

Tritan-Drill-Reamer

Drill reamer
SDR301G (5xD), internal coolant supply

Design:
 Drill diameter: 3.80 – 20.05 mm
 Bore tolerance: \geq IT 7
 Cutting material: HP358
 Number of cutting edges: 3
 Number of guiding chamfers: 6
 Tip angle: 140°
 Side rake angle: 30°

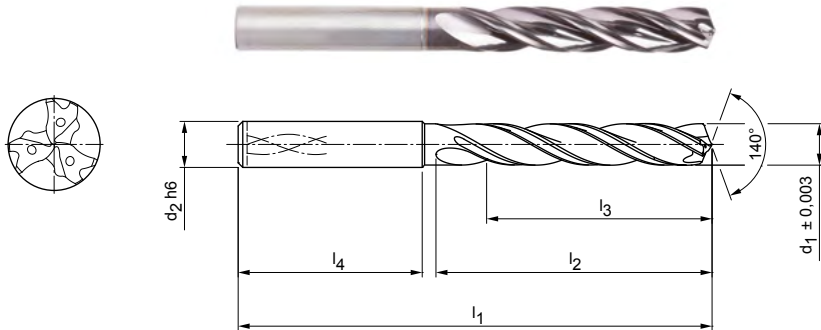

Stocked preferred series in shank form HA

Dimensions						Shank form HA	
d1 +/-0.003	d2 h6	l1	l2	l3	l4	Specification	Order no.
3,99	6	74	36	29	36	SDR301G-3.990+3-3-HA05-HP358	31196639
4,00	6	74	36	29	36	SDR301G-4.000+3-3-HA05-HP358	31196640
4,01	6	74	36	29	36	SDR301G-4.010+3-3-HA05-HP358	31196641
4,02	6	74	36	29	36	SDR301G-4.020+3-3-HA05-HP358	31196642
4,99	6	82	44	35	36	SDR301G-4.990+3-3-HA05-HP358	31196645
5,00	6	82	44	35	36	SDR301G-5.000+3-3-HA05-HP358	31196646
5,01	6	82	44	35	36	SDR301G-5.010+3-3-HA05-HP358	31196647
5,99	6	82	44	35	36	SDR301G-5.990+3-3-HA05-HP358	31196651
6,00	6	82	44	35	36	SDR301G-6.000+3-3-HA05-HP358	31196652
6,01	6	82	44	35	36	SDR301G-6.010+3-3-HA05-HP358	31196653
7,99	8	91	53	43	36	SDR301G-7.990+3-3-HA05-HP358	31196658
8,00	8	91	53	43	36	SDR301G-8.000+3-3-HA05-HP358	31196659
8,01	8	91	53	43	36	SDR301G-8.010+3-3-HA05-HP358	31196660
8,02	8	91	53	43	36	SDR301G-8.020+3-3-HA05-HP358	31196661
9,99	10	103	61	49	40	SDR301G-9.990+3-3-HA05-HP358	31196664
10,00	10	103	61	49	40	SDR301G-10.000+3-3-HA05-HP358	31196665
10,01	10	103	61	49	40	SDR301G-10.010+3-3-HA05-HP358	31196666
11,99	12	118	71	59	45	SDR301G-11.990+3-3-HA05-HP358	31196670
12,00	12	118	71	59	45	SDR301G-12.000+3-3-HA05-HP358	31196671
12,01	12	118	71	59	45	SDR301G-12.010+3-3-HA05-HP358	31196672
13,99	14	124	77	60	45	SDR301G-13.990+3-3-HA05-HP358	31196676
14,00	14	124	77	60	45	SDR301G-14.000+3-3-HA05-HP358	31196677
14,01	14	124	77	60	45	SDR301G-14.010+3-3-HA05-HP358	31196678
15,99	16	133	83	63	48	SDR301G-15.990+3-3-HA05-HP358	31196682
16,00	16	133	83	63	48	SDR301G-16.000+3-3-HA05-HP358	31196683
16,01	16	133	83	63	48	SDR301G-16.010+3-3-HA05-HP358	31196684

Continued on next page.

Tritan-Drill-Reamer | Drill reamer SDR301G (5xD), internal coolant supply

Configurable features

**Diameter:**

Diameter in increments of
0.001 mm freely selectable

**Specification:**

SDR301G-[diameter]+3-3-HA05-HP358

Example:

SDR301G-04001+3-3-HA05-HP358

Tool diameter $d_1 = 4.001$ mm

Dimensions of configurable series

d_1 min.	d_1 max.	d_2 h6	l_1	l_2	l_3	l_4
3,800	4,700	6	74	36	29	36
4,701	6,050	6	82	44	35	36
6,051	8,050	8	91	53	43	36
8,051	10,050	10	103	61	49	40
10,051	12,050	12	118	71	56	45
12,970	14,050	14	124	77	60	45
14,970	16,050	16	133	83	63	48
16,800	18,050	18	143	93	71	48
18,700	20,050	20	153	101	77	50

Dimensions in mm.

For tolerance class fit bores up to max. IT7, with sufficient machine stability and cooling.

For help in calculating the optimum nominal diameter for different fitting bores, please refer to the information field at the end of the chapter.

For cutting data recommendations, see end of chapter.

Special designs and other coatings available upon request.

Tritan-Drill-Reamer

Drill reamer
SDR301 (5xD), internal coolant supply

Design:
 Drill diameter: 4.00 – 20.00 mm
 Bore tolerance: \geq IT 7
 Cutting material: HP358
 Number of cutting edges: 3
 Number of guiding chamfers: 6
 Tip angle: 140°
 Side rake angle: 30°

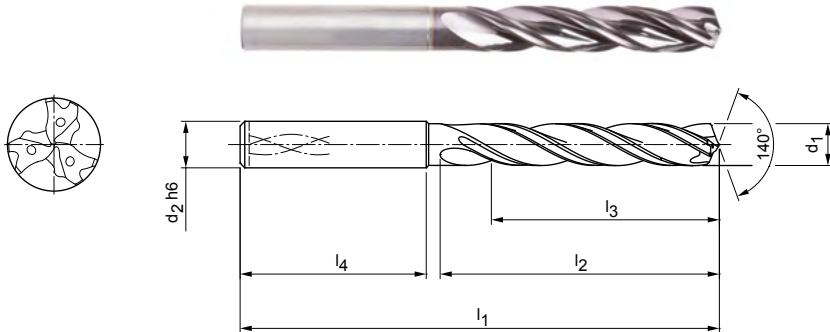

Stocked preferred series in shank form HA

Dimensions						Shank form HA	
d ₁ H7	d ₂ h6	l ₁	l ₂	l ₃	l ₄	Specification	Order no.
4,00	6	74	36	29	36	SDR301-4.000H7-HA05-HP358	31196627
5,00	6	82	44	35	36	SDR301-5.000H7-HA05-HP358	31196628
6,00	6	82	44	35	36	SDR301-6.000H7-HA05-HP358	31196629
8,00	8	91	53	43	36	SDR301-8.000H7-HA05-HP358	31196630
10,00	10	103	61	49	40	SDR301-10.000H7-HA05-HP358	31196631
12,00	12	118	71	56	45	SDR301-12.000H7-HA05-HP358	31196632
14,00	14	124	77	60	45	SDR301-14.000H7-HA05-HP358	31196633
16,00	16	133	83	63	48	SDR301-16.000H7-HA05-HP358	31196634
18,00	18	143	93	71	48	SDR301-18.000H7-HA05-HP358	31196635
20,00	20	153	101	77	50	SDR301-20.000H7-HA05-HP358	31196636

Dimensions in mm.
 For tolerance class fit bores of H7, with sufficient machine stability and cooling.
 For cutting data recommendations, see end of chapter.
 Special designs and other coatings available upon request.

Cutting data recommendations for drill reamer

Feed and cutting speed

Tritan-Drill-Reamer | SCD641

MMG*	Workpiece material		Strength/hardness [N/mm ²] [HRC]
P	P1	P1.1 Structural, free-cutting, case hardened and heat-treated steels, non-alloy	< 700
		P1.2 Structural, free-cutting, case hardened and heat-treated steels, non-alloy	< 1,200
	P2	P2.1 Nitrided, case hardened and heat-treated steels, alloy	< 900
		P2.2 Nitrided, case hardened and heat-treated steels, alloy	< 1,400
	P3	P3.1 Tool, bearing, spring and high-speed steels**	< 800
		P3.2 Tool, bearing, spring and high-speed steels**	< 1,000
		P3.3 Tool, bearing, spring and high-speed steels**	< 1,500
	P5	P5.1 Cast steel	
K	K1	K1.1 Cast iron with lamellar graphite (grey cast iron), GJL	< 300
		K2.1 Cast iron with spheroidal graphite, GJS	< 500
	K2	K2.2 Cast iron with spheroidal graphite, GJS	≤ 800
		K2.3 Cast iron with spheroidal graphite, GJS	> 800
	K3	K3.1 Cast iron with spheroidal graphite, GJV; malleable cast iron, GJM	< 500
		K3.2 Cast iron with spheroidal graphite, GJV; malleable cast iron, GJM	> 500

EXAMPLE CALCULATION

Please note that the result may be influenced by additional parameters such as the machine tool or tool clamping.

Formula for calculating the optimum nominal tool diameter:

$$(G_{OB} + G_{UB}) / 2$$

Example:

- Fitting bore: \varnothing 10 F7
- Maximum bore dimension G_{OB} : 10.028 mm
- Minimum bore dimension G_{UB} : 10.013 mm

$$\rightarrow (10.028 \text{ mm} + 10.013 \text{ mm}) / 2 = 10.021 \text{ mm} = \text{selection of tool nominal diameter } 10.021 \text{ mm}$$

* MAPAL machining groups

** If the alloy parts Cr, Mo, Ni, V, W in total > 8% then select the next highest MAPAL machining group.

	Cutting speed v_c [m/min]				Feed f [mm] for drill diameter					
	Internal cooling	External cooling	MQL	Air	4.00	5.50	7.50	10.50	14.50	20.00
	70	65	65		0.17	0.22	0.27	0.34	0.41	0.47
	65	55	55		0.22	0.27	0.34	0.42	0.51	0.59
	70	60	60		0.20	0.26	0.32	0.40	0.48	0.56
	50	40	40		0.17	0.21	0.26	0.32	0.38	0.44
	55	45	45		0.18	0.23	0.29	0.36	0.43	0.50
	40	40	40		0.15	0.19	0.24	0.30	0.36	0.41
	40	30	35		0.13	0.16	0.19	0.23	0.28	0.32
	70	60	60		0.20	0.26	0.32	0.40	0.48	0.56
	100	70	70	70	0.25	0.33	0.42	0.55	0.67	0.79
	135	85	100	100	0.24	0.32	0.40	0.51	0.62	0.72
	85	65	65		0.22	0.28	0.35	0.44	0.54	0.62
	50	35	45		0.11	0.13	0.16	0.20	0.24	0.28
	75	70	70		0.23	0.30	0.38	0.47	0.58	0.67
	70	60	60		0.20	0.25	0.31	0.38	0.46	0.53

The specified cutting values are guide values.

The optimum data for the respective machining task should be determined during the test or machining.

SPECIAL SOLUTIONS

Drilling from the solid with solid carbide

Along with a comprehensive standard range of drilling tools, MAPAL also offers custom tools.

Individual customer requirements demand bespoke solutions that are specifically tailored to the machining tasks. With its vast know-how in machining metal and many years of experience, MAPAL is your competent partner worldwide when it comes to the design and manufacturing of custom tools, as well as the design of complete machining processes for drilling. The range includes twisted and straight-fluted drills as well as step drills produced of solid carbide and PCD-tipped drills.

MAPAL – your partner for application-specific custom solutions.



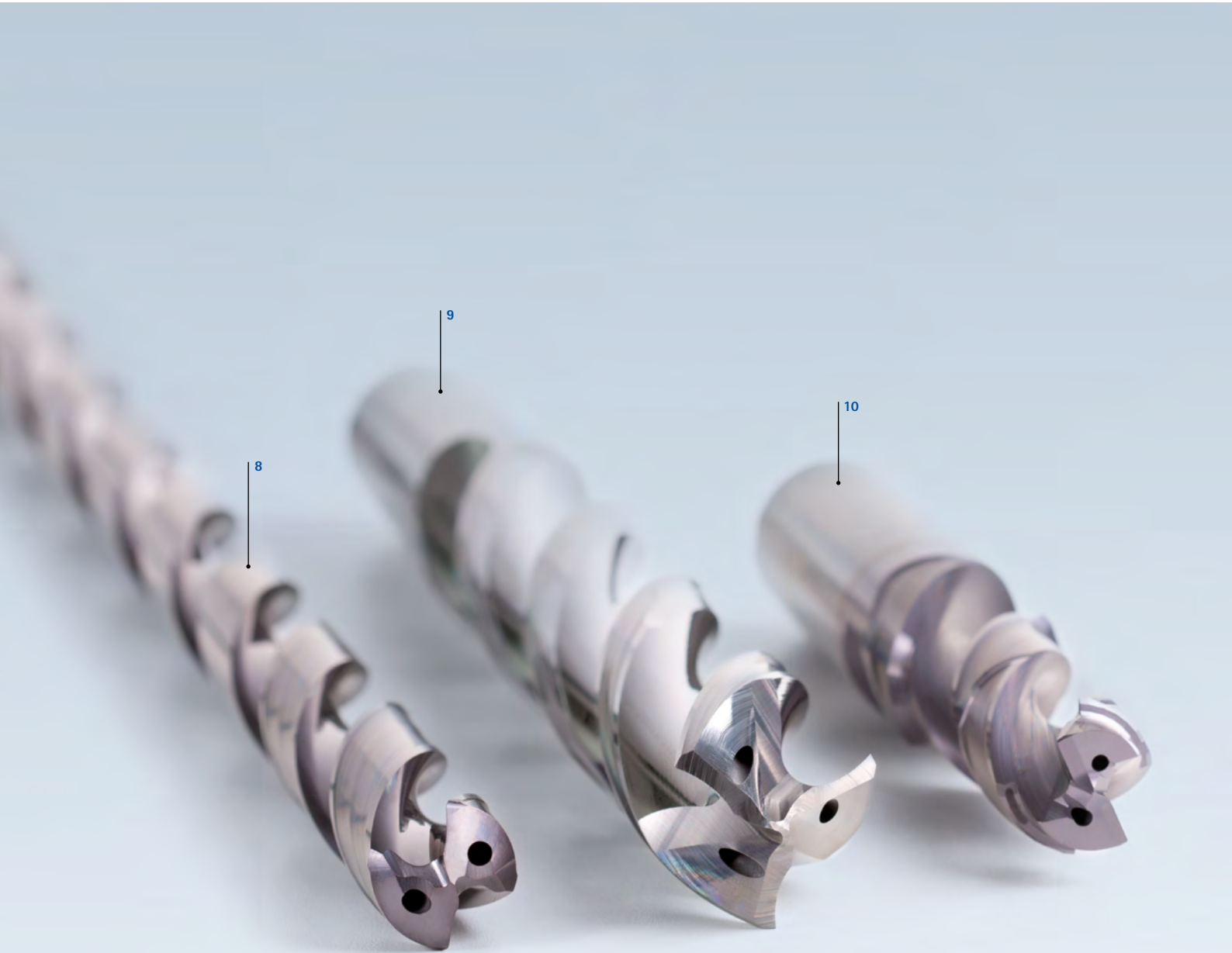

Custom tools for drilling from MAPAL

- 1 Custom solid carbide step drill with three cutting edges, self-centring chisel edge, for connecting rod machining in one shot
- 2 Solid carbide step drill with three guiding chamfers and special coating for high-speed machining
- 3 Solid carbide core-bore drill for connecting rod machining in a two-shot process
- 4 Solid carbide step drill with three guiding chamfers and special coating for the high-speed machining of automotive constant-velocity joints produced of ADI 900
- 5 Custom solid carbide drill with Tritan-Drill geometry and special coating for turbo-charger machining
- 6 Drill reamer with three cutting edges and additional reaming cutting edge on the periphery with special coating for machining axles produced of GJS
- 7 Solid carbide spotting drill for connecting rod machining in a two-step process
- 8 Solid carbide deep drill with custom coating for machining cylinder blocks produced of GJV
- 9 Solid carbide aluminium drill with three cutting edges, self-centring chisel edge and highly polished chip flutes for machining AISi1
- 10 Solid carbide step drill with 180° face geometry for valve machining



SPECIAL SOLUTIONS

Drilling from the solid with PCD

During the machining of parts produced of aluminium and other non-ferrous metals, straight-fluted PCD drilling tools are used for drilling for the most part. The tool features are optimally matched for the high performance of the PCD drills. The chip flutes are polished along the entire length of the drill to keep the chip friction as low as possible. The optimally embedded PCD cutting edges result in good soft cutting behaviour of the drill. In this way, less heat is introduced into the part.

For processes with minimum quantity lubrication (MQL), MAPAL has positioned the coolant outlets on the tools so that the aerosol arrives exactly where it is required for lubrication, reducing the risk of built-up edges and increasing the tool life of the drill.

However, modern machining processes increasingly require PCD-tipped drilling tools with a large helix angle.

The twisted PCD tools make reliable, productive bore machining possible. Chip congestion or tool fracture is prevented by "mechanically assisted" removal of the chips. Highly positive rake angles reduce the cutting forces required. Several machining steps such as drilling from the solid or boring processes can be undertaken in one machining step. The reduction of the machining time increases productivity, with high process reliability and bore quality.

Tool features in detail



1 PCD cutting edges

2 Twisted and highly polished chip flute

3 Optimised coolant outlets for MQL process

Optimally embedded PCD cutting edges

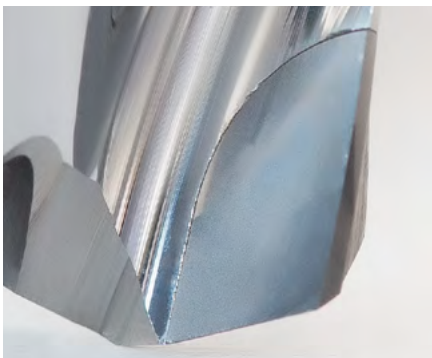

The embedding of PCD segments in a twisted slot rounded on all sides places high demands on the production technology. The latest production equipment ensures that twisted PCD drilling tools can be designed and manufactured reliably and reproducibly. To keep improving the tools, comprehensive application details flow via the technical consultants and production specialists at MAPAL into the design and the construction.

Highly polished chip flutes



The chip flutes are highly polished, such that the friction produced by the chips is reduced and as a consequence the heat introduced to the part is also reduced. The twisted design of the chip flutes makes the "mechanically assisted" removal of the chips possible. Highly positive rake angles reduce the cutting forces required.

Ideal for MQL processes



The correct positioning of the coolant outlets is crucial for the performance of the drill during MQL machining. The aerosol must arrive exactly where it is required for lubrication. This reduces the risk, for example, of built-up edges and of course also helps to increase the tool life of the drill.



REAMING AND FINE BORING

Highest levels of accuracy guaranteed with the MAPAL principle



PRODUCT OVERVIEW

Reaming and fine boring

Tools for the fine machining of bores represent the core competence of MAPAL. The "original reamer" produced in 1954 marked the beginning of the success story that MAPAL continues to write today in this area. Decades of experience and continuous further development and optimisation of the tool solutions ensure that MAPAL offers the right solution according to the complexity of the machining and the precision requirements. In addition to customised special solutions, a diverse standard range of tools for reaming and fine boring is available.

Reaming and fine boring are the most common methods for the fine machining of bores, yielding impressive, precise results. This is be-

cause MAPAL tools are produced with the same high levels of precision that they deliver in practice. Whatever the complexity of the machining and the requirements placed on precision and surface finish, MAPAL has the appropriate solution:

Single-bladed reamers, fine boring tools with guide pads and WP cutting edges all deliver the highest levels of precision. On top of that, the range also includes fixed multi-bladed reamers: HPR replaceable head reamers with high-precision clamping system, high-performance reamers produced of carbide or cermet as well as systems for machining large diameters.



Basic
LINE





Basic Line:
Universal tools, wide range of applications, low acquisition costs

Performance
LINE

Performance Line:
High-performance tools, broad field of application, high productivity in series production

Expert
LINE

Expert Line:
Specialist tools for selected applications, maximum precision and productivity

Fixed multi-bladed reamers		Tools with guide pads	
 <p>High-performance reamer FXR</p> <p>The high-performance reamers of the FXR series (the tools of choice when short cycle times are required) are available with different cutting materials and coatings. This means that almost all workpiece materials can be machined economically and reliably with them. Without any setting effort, the tools, which are available in the diameter range 2.800 to 20.200 mm, achieve IT7 tolerances.</p> <p>∅ range: 2.800-20.200 mm*</p> <p>P M K N C S</p>	 <p>Tipped high-performance reamers MOR</p> <p>Simple, efficient and standardised – this is how the reaming system of the Mono-Ream series can be summarised. The cutting edges of the high-performance reamers of the FXR series are brazed onto the tool body. The MOR reamers (in contrast to the FXR reamers) can be reprocessed. For this purpose, they are equipped with an expansion screw that expands the diameter of the reamer and thus enables regrinding.</p> <p>∅ range: 3.850-40.200 mm*</p> <p>P K N</p>	 <p>HPR replaceable head reamers with HFS connection</p> <p>If maximum economic efficiency is required, the use of HPR replaceable head reamers is recommended in the small diameter range. The high-precision connection HFS guarantees (despite the replaceable head system) an exact radial run-out as well as a high changeover accuracy. Handling is very simple. The HPR reamers are available with fixed brazed cutting edges as well as with adjustable cutting edges.</p> <p>∅ range: 7.000-65.000 mm*</p> <p>P M K S</p>	 <p>Single bladed reamer</p> <p>When it comes to achieving the greatest possible precision, single bladed reamers with guide pads based on the MAPAL principle are virtually unrivalled. Their cutting inserts are available with two cutting edges and special leads.</p> <p>∅ range: 5.000-30.290 mm*</p> <p>P M K N S H</p>
Page 316	Page 350	Page 368	Page 478

* The diameter range can vary, depending on the series.

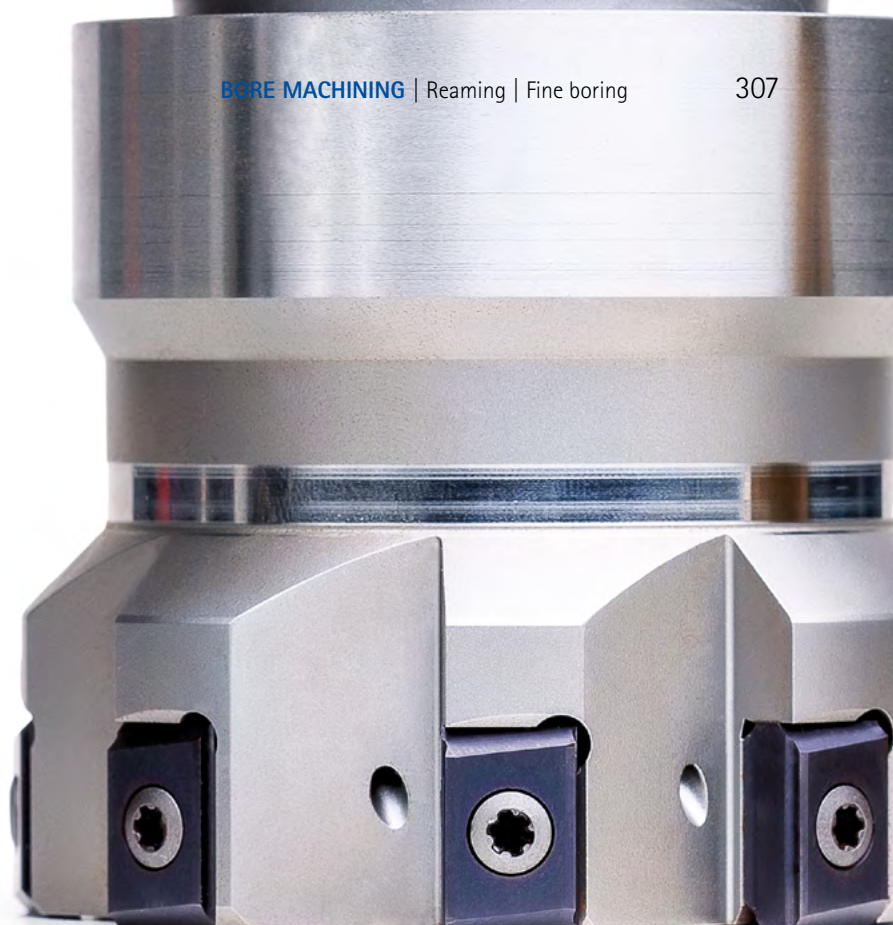

	Solutions for large diameters	Special solutions
		
<p>EasyAdjust system</p> <p>When developing the EasyAdjust system, the goal was to drastically reduce the setting effort for tools with guide pad technology. The heart of the system is an innovative cassette that holds the six- or four-edge indexable inserts securely without any play. The back taper of the minor cutting edge is already integrated into this cassette, thus eliminated the need for this adjustment. Due to the exact guidance of the cassette on a precision guide pin, the back taper remains unchanged even during diameter settings.</p> <p>Ø range: from 20.000 mm*</p> <p>P M K N S H</p>	<p>Solutions for large diameters</p> <p>Multi-bladed high-performance reamers for large diameter ranges. HPR400: Quick change of cutting edges on site without long reconditioning. HPR400 plus: Four instead of the previous single cutting edge. Indexable blades easily rotated and changed.</p> <p>Ø range: 63.000-319.999 mm*</p> <p>P M K N H</p>	<p>Tailor made special tools</p> <p>Special machining tasks require special tools. This is why MAPAL offers reaming tools in special designs that are individually tailored to the customer's requirements. With special lead geometries and coatings as well as multi-stage tools, the respective tasks are optimally fulfilled. Combination solutions with other tool technologies from MAPAL can also increase productivity and reduce non-productive times.</p>
<p>Page 514</p>	<p>Page 562</p>	<p>Page 572</p>

SELECTION SYSTEM

Fixed multi-bladed reamers | Tools with guide pads



Fixed multi-bladed reamers

First choice for the following applications:

- Machining with high feed rates
 - Highest output in series production
 - Abrasive and hard workpiece materials
 - Multi-spindle machining
 - Machining in diameter < 5 mm
-

Tools with guide pads

First choice for the following applications:

- Unstable machining conditions
 - Optimal with floating holder on the lathe
 - Bar machining and thin-walled parts
 - Unfavourable length and diameter ratios
 - Extremely high shape and position tolerances
- 
- 



Drastically reduced machining times are possible using fixed multi-bladed reamers. The multiple blades permit a higher feed rate, which ultimately reduces machining times. Thanks to specifically developed systems and

the latest manufacturing technology, MAPAL also offers these tools with the highest accuracies.

► [More from page 311](#)

TOOL PROPERTIES

- Fixed design without any setting effort
- Finely adjustable version optimised for regrinding
- Highly exact replaceable head system for simple handling
- Various performance classes in the standard programme
- Reconditioning for higher cost-effectiveness
- Preferred series available from stock, intermediate sizes quickly available



The MAPAL guide pad technology is unrivalled when it comes to the fine machining of bores in any material. The precision of the bore diameter, roundness and cylindrical form as well as the surface finish cannot be produced by

other production means, or at least cannot be achieved cost-effectively.

► [More from page 477](#)

TOOL PROPERTIES

- Maximum accuracy thanks to exact and μ -precise settings
- Insert technology for maximum flexibility in the choice of cutting material
- Intermediate sizes and all tolerances available at short notice



FIXED MULTI-BLADED REAMERS

Fixed multi-bladed reamers

Selection system	312
------------------------	-----

FixReam FXR

Product overview	316
Article overview FXR	318
FXR510	322
FXR500	330
FXR505	332
FXR503 short	342
FixReam cutting data	344

MonoReam MOR

Product overview	350
Article overview MOR	352
MOR710	356
MOR700	358
MOR705	359
MRP510	362
MRP505	363
MOR cutting data	364

HPR replaceable head reamers











Product overview	368
Article overview HPR	370
HPR130	374
HPR131	379
HPR100	383
HPR110	390
HPR180	396
HPR150	405
HPR230	414
HPR231	418
HPR200	422
HPR210	426
HPR280	430
HPR250	438
HPR cutting data	446
HFS holder range	460
Spare parts and accessories	474



SELECTION OF MULTI-BLADED REAMERS

Step by step to the right reamer

Are you looking for a solid carbide multi-bladed reamer in diameter 10.000 H7 for blind bore machining in steel, for example? This selection aid guides you step by step to the right reamer.

1	Design	Select your preferred design (monolithic or modular).	 Monolithic	 HFS modular connection
2	Bore features	Check that the geometric features meet your requirements. Select the diameter range and the required tolerance.	 Diameter range	 Achievable bore tolerance $\geq IT7$
3	Product category	Choose a product category.	 Basic Line: Universal tools, wide range of applications, low acquisition costs	
4	Material suitability	Identify your workpiece material as per the MMG (MAPAL machining group).	 Steel	 Stainless steel
5	Type of bore	Check the requirements that are placed on your tool by the type of bore.	 Through bore	 Blind bore
6	Product	Select your reamer. Products from the stocked preferred series are available at short notice, while products with configurable features can be freely configured within predefined limits.	 Stocked preferred series	 Free configuration

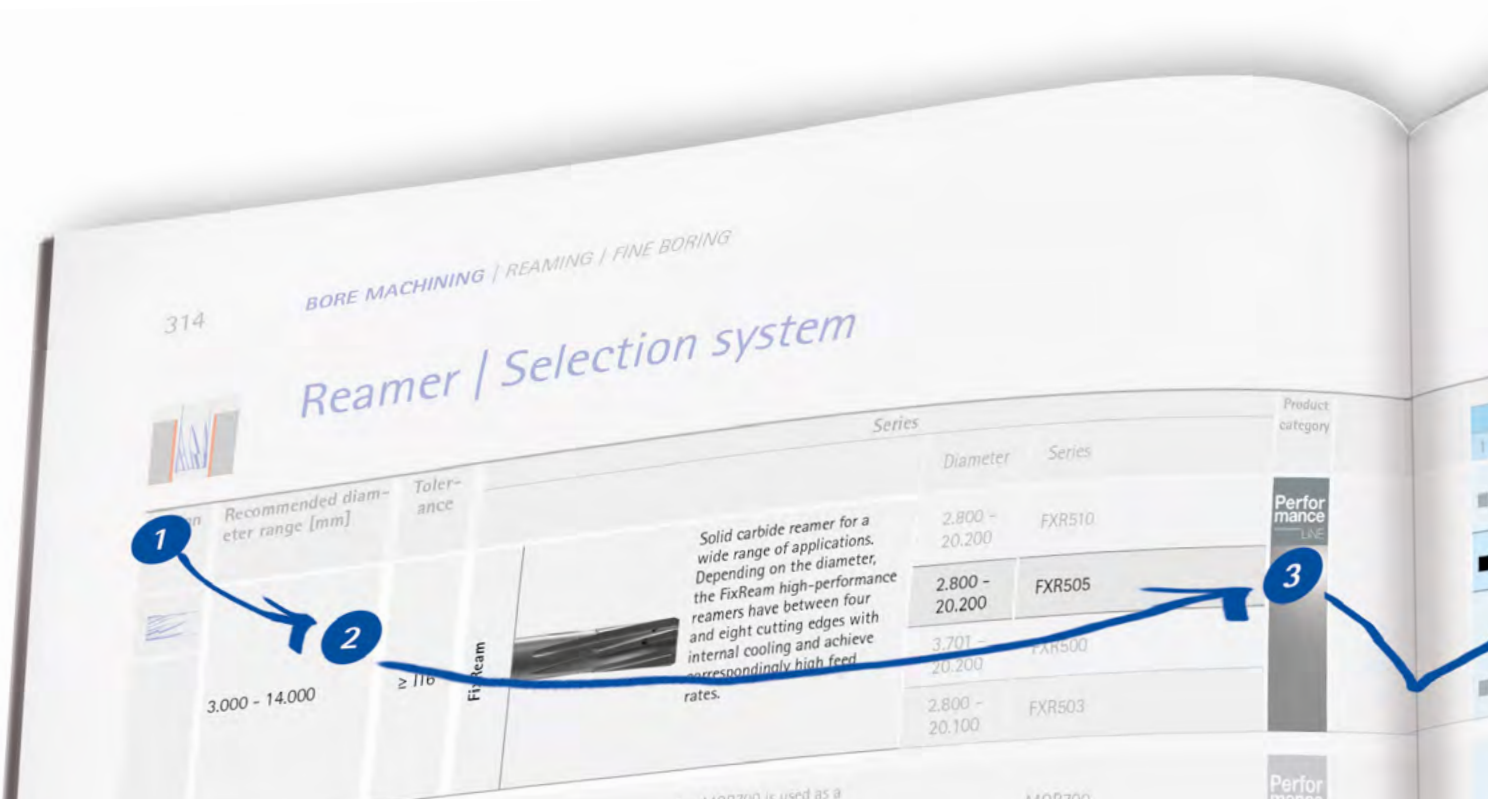



Performance Line:
High-performance tools, broad field of application, high productivity in series production manufacturing



Expert Line:
Specialist tools for selected applications, maximum precision and productivity



Cast iron



Non-ferrous metals and plastics

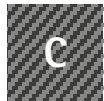

Composite materials



Super alloy and titanium



Hardened steel and cast steel

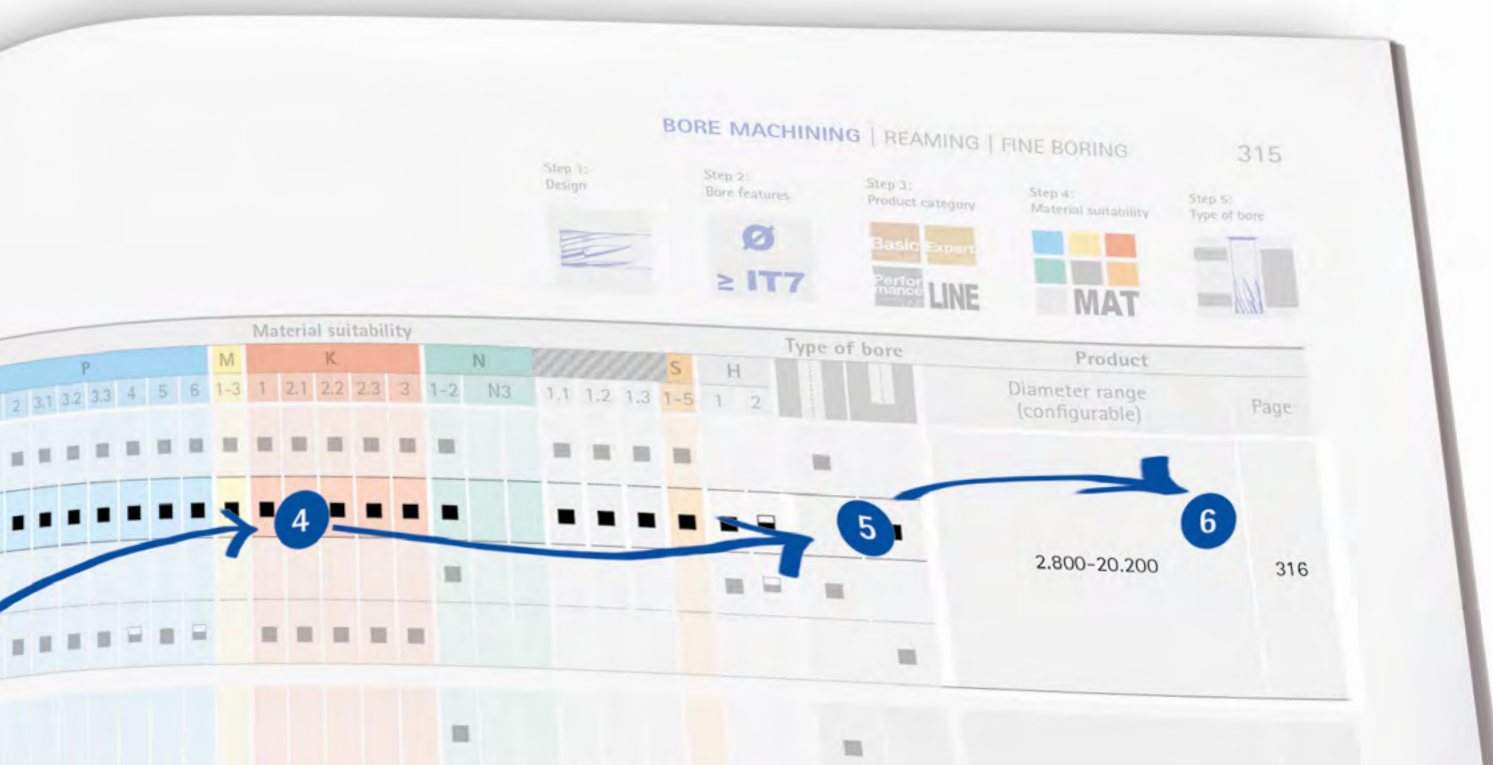



Reamer | Selection system

Design	Recommended diameter range [mm]	Tolerance	Series			Product category	
				Diameter	Series		
	3.000 - 14.000	≥ IT6	FixReam	<p>Solid carbide reamer for a wide range of applications. Depending on the diameter, the FixReam high-performance reamers have between four and eight cutting edges with internal cooling and achieve correspondingly high feed rates.</p>	2.800 - 20.200*	FXR510	Performance LINE
					2.800 - 20.200*	FXR505	
					3.701 - 20.200*	FXR500	
					2.800 - 20.100*	FXR503	
	14.000 - 40.000	≥ IT6	MonoReam	<p>The MOR700 is used as a fixed tool, but this series is optimised for regrinding. The reamer is expanded in diameter using a one-piece expansion screw.</p>	7.700 - 40.200	MOR700	Performance LINE
						MOR705	
						MOR710	
	4.000 - 8.000	≥ IT6	MonoReam Plus	<p>Especially for machining cast iron and steel. A sleeve ensures the optimal supply of coolant to the HPC blades.</p>	3.850 - 8.200	MRP505	Performance LINE
						MRP510	
	7.000 - 65.000	≥ IT5	HPR	<p>High-precision replaceable head system in fixed and fine-adjustable design.</p>	7.000 - 65.000	HPR1XX fixed	Performance LINE Expert LINE
						7.000 - 65.000	
	63.000 - 319.999	≥ IT7	HPR 400 400 plus	<p>Exchangeable cutting edges make it easy to replace the cutting edge on site. This results in very short set-up times.</p>	63.000 - 319.999	HPR400 400 plus	Expert LINE

* The diameter range can vary, depending on the series.

Step 1:
Design



Step 2:
Bore features



Step 3:
Product category



Step 4:
Material suitability



Step 5:
Type of bore



	Material suitability															Type of bore				Product									
	P						M	K					N		S			H		Diameter range (configurable)	Page								
	1	2	3.1	3.2	3.3	4	5	6	1-3	1	2.1	2.2	2.3	3	1-2	N3	1.1	1.2	1.3			1-5	1	2					
	■	■	■	■	■	■	■	■	■	■	■	■	■	■		■	■	■	■			■	■			2.800-20.200*	316		
	■	■	■	■	■	■	■	■	■	■	■	■	■	■		■	■	■	■	■	■	■	■						
														■						■	■	■	■						
	■	■	■	■	■	■	■		■	■	■	■	■											■	■				
														■	■									■	■	7.700-40.200	350		
	■	■	■	■	■	■	■		■	■	■	■	■	■	■									■	■				
	■	■	■	■	■	■	■		■	■	■	■	■											■	■				
	■	■	■	■					■	■														■	■	3.850-8.200	350		
	■	■	■	■					■	■														■	■				
	■	■	■	■	■	■	■	■	■	■	■	■	■	■					■					■	■	7.000-65.000	368		
	■	■	■	■	■	■	■	■	■	■	■	■	■	■					■					■	■				
	■	■	■	■	■	■	■	■	■	■	■	■	■	■										■	■	63.000-319.999	562		

PRODUCT OVERVIEW

FixReam: FXR500 | FXR510 | FXR505 | FXR503

The FXR series of high-performance reamers produced of solid carbide cover a wide range of applications. Depending on the diameter, the FixReam high-performance reamers have between four to eight cutting edges with internal cooling and achieve correspondingly high feed rates. Thanks to different cutting materials and coatings, numerous workpiece materials can be machined economically and reliably in the diameter range from 2.850 to 20.200 mm* without an adjustment process in the IT7 tolerance range.

For use where space is limited, for example on automated lathes, "short" versions are available.



FixReam



FixReam | FXR500 solid carbide

Straight fluted high-performance reamer with internal cooling produced of solid carbide. As a preferred series in H7.

Preferred series \varnothing range: 3.701 – 20.200 mm*



FixReam | FXR510 solid carbide

Left-hand fluted high-performance reamer with internal cooling produced of solid carbide. As a preferred series in H7.

Preferred series \varnothing range: 2.800 – 20.200 mm*





FixReam | FXR505 solid carbide

Straight fluted high-performance reamer with internal cooling produced of solid carbide. As a preferred series in H7.

Preferred series \varnothing range: 2.800-20.200 mm*



FixReam | FXR503 short, solid carbide

Extra-short high-performance reamer produced of solid carbide, specially designed for use on automated lathes. As a preferred series in H7.

Preferred series \varnothing range: 2.800-20.100 mm*



Article overview FixReam (1/2)

Product category	Type of bore	Material suitability													
		P				M	K	N				S	H		
		1-3	4	5	6	1-3	1-3	1	2	4	1	1-5	1	2	
Performance LINE		■	■	■	■		■								
			■		■	■									
									■						
									■	■	■				
		■	■	■	■		■								
		■	■	■	■		■								

Ordering example:

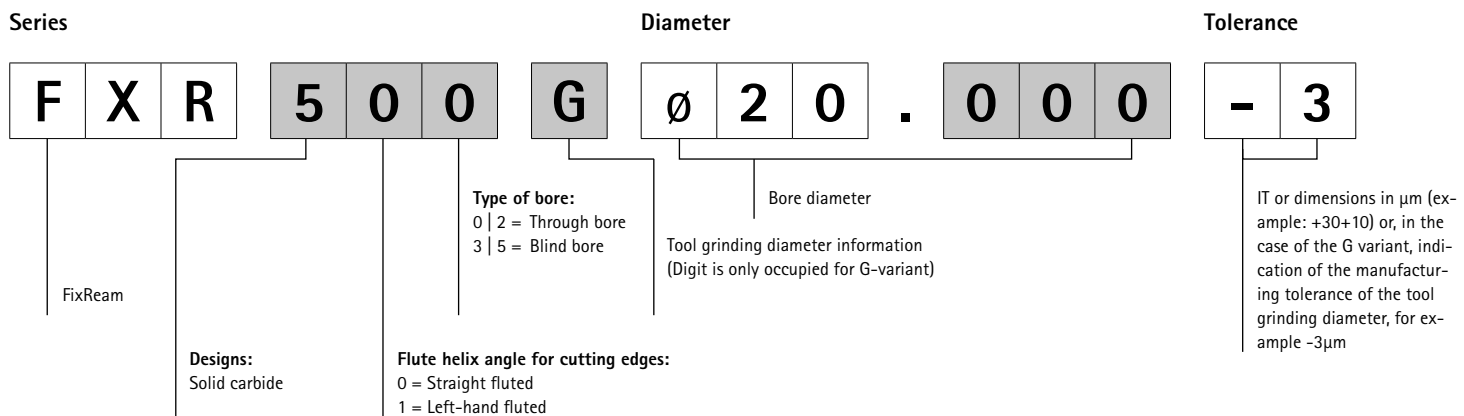

Step 1:
Product category



Step 2:
Type of bore



Step 3:
Material suitability



Step 4:
Design



Step 5:
Preconfigured diameters or configuration



	Design					Preconfigured diameters		Configuration
	d1	Cutting material	Lead			Series	Page	
	2.800-20.200	HP145	MG1M	■		FXR510	322	FXR510 Fixed design, left-hand fluted, for through bores
	3.701-20.200	HP145	MF1M	■		FXR510	326	
	3.701-20.200	HP622	MG0A		■	FXR500	330	
	2.800-20.200	HU612	MG1M	■		FXR510	324	
	3.701-20.200	HC614	MF1M	■		FXR510	329	FXR500 Fixed design, straight fluted, for through bores
	3.701-20.200	HP625	MF1M	■		FXR510	328	
	3.701-20.200	HP141	MFOA		■	FXR500	331	
	2.800-20.200	HP145	MV0A		■	FXR505	332	FXR505 Fixed design, straight fluted, for blind bores
	2.800-20.100	HP145	MC1F		■	FXR503	342	
	3.701-20.200	HP145	MT0A		■	FXR505	334	
	3.701-20.200	HP622	MV0A		■	FXR505	335	
	2.800-20.200	HU612	MV0A		■	FXR505	336	FXR503 short Fixed design, straight fluted, for blind bores
	3.701-20.200	HC614	MV0A		■	FXR505	339	
	3.701-20.200	HP625	MT0A		■	FXR505	338	
	3.701-20.200	HP141	MT0A		■	FXR505	340	

Series configuration on next page.

Lead

Cutting material

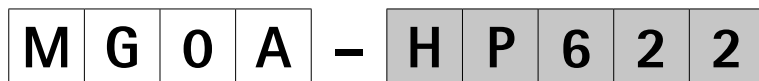

Lead geometry and rake angle:
 MGOA MT0A For explanation of
 MG1M MFOA the lead geometries,
 MF1M MC1F see pages 752
 MV0A

Cutting material:
 HP145 HP141
 HU612 HP625
 HP622
 HC614

Article overview FixReam | Configuration (2/2)

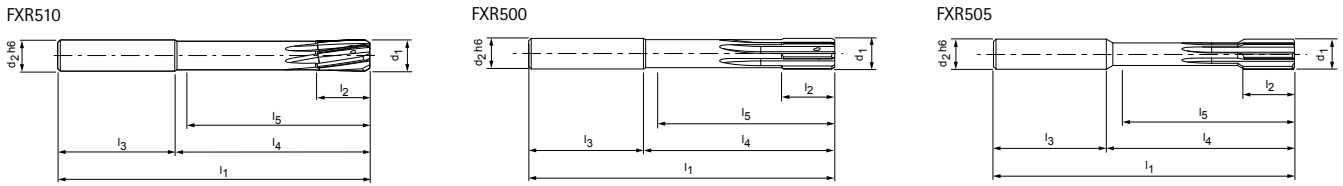

Tool dimensions

FXR510

d ₁	d ₂	l ₁	l ₂	l ₃	l ₄	l ₅	z
2,800 - 3,700	4	65	12	28	37	34	4
3,701 - 4,700	6	75	12	36	39	34	4
4,701 - 6,200	6	75	12	36	39	35	4
6,201 - 7,200	8	100	16	36	64	59	6
7,201 - 8,200	8	100	16	36	64	60	6
8,201 - 9,200	10	100	20	40	60	55	6
9,201 - 10,200	10	120	20	40	80	76	6
10,201 - 11,200	12	120	20	45	75	70	6
11,201 - 12,200	12	120	20	45	75	71	6
12,201 - 14,200	14	130	22	45	85	80	6
14,201 - 15,200	16	130	22	48	82	77	6
15,201 - 16,200	16	150	25	48	102	97	6
16,201 - 18,200	18	150	25	48	102	97	8
18,201 - 20,200	20	150	25	50	100	95	8

FXR505

d ₁	d ₂	l ₁	l ₂	l ₃	l ₄	l ₅	z
2,800 - 3,350	4	65	12	37	28	33	4
3,351 - 3,700	4	65	12	28	37	33	4
3,701 - 6,200	6	75	12	36	39	34	4
6,201 - 8,200	8	100	16	36	64	58	6
8,201 - 9,200	10	100	20	40	60	54	6
9,201 - 10,200	10	120	20	40	80	74	6
10,201 - 12,200	12	120	20	45	75	68	6
12,201 - 14,200	14	130	22	45	85	78	6
14,201 - 15,200	16	130	22	48	82	75	6
15,201 - 16,200	16	150	25	48	102	95	6
16,201 - 18,200	18	150	25	48	102	95	6
18,201 - 20,200	20	150	25	50	100	92	6

Tolerances for the G variant/fixed variant FXR5XX:

Cutting material	Diameter range
	Ø2.800-20.200
Uncoated	-0.003
HU612	
Coated (layer thickness 0.8-2 µm)	-0.004
HP145	
HP625	
HP622	
HC614	
Coated (layer thickness 2-4 µm)	-0.005
HP141	

Explanation of the G variant FXR

Permissible workpiece tolerances for selecting the tool diameter

G variant design:

The G variant indicates the tool diameter of the reamer with our manufacturing tolerances. The manufacturing tolerances depend on the cutting material; see permissible smallest tolerances for the G variant.

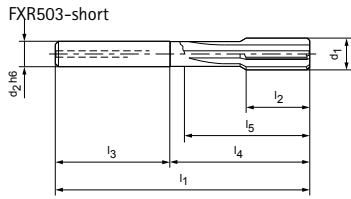

FXR500

d_1	d_2	l_1	l_2	l_3	l_4	l_5	z
3,701 - 4,700	6	75	12	36	39	34	4
4,701 - 6,200	6	75	12	36	39	35	4
6,201 - 7,200	8	100	16	36	64	59	6
7,201 - 8,200	8	100	16	36	64	60	6
8,201 - 9,200	10	100	20	40	60	55	6
9,201 - 10,200	10	120	20	40	80	76	6
10,201 - 11,200	12	120	20	45	75	70	6
11,201 - 12,200	12	120	20	45	75	71	6
12,201 - 14,200	14	130	22	45	85	80	6
14,201 - 15,200	16	130	22	48	82	77	6
15,201 - 16,200	16	150	25	48	102	97	6
16,201 - 18,200	18	150	25	48	102	97	8
18,201 - 20,200	20	150	25	50	100	95	8

FXR503-short

d_1	d_2	l_1	l_2	l_3	l_4	l_5	z
2,800 - 4,050	4	56	12	28	28	24	4
4,051 - 5,100	6	64	12	36	28	23	4
5,101 - 5,600	6	64	12	36	28	24	4
6,101 - 6,600	8	75	16	36	39	32	6
6,601 - 7,100	8	75	16	36	39	34	6
7,101 - 8,100	8	75	16	36	39	35	6
8,101 - 10,100	8	75	20	36	39	35	6
10,101 - 11,600	10	80	20	40	40	35	6
11,601 - 13,100	12	90	22	45	45	40	6
13,101 - 15,100	14	90	22	45	45	40	6
15,101 - 18,100	16	100	25	48	52	47	8
18,101 - 20,100	18	100	25	48	52	47	8



Customised special solutions for multi-stage machining.

FixReam

Fixed design, left-hand fluted, for through bores
FXR510

Design:

Reamer diameter:
Lead:
Cutting material:

2.800–20.200 mm
MG1M
HP145
Carbide
PVD-coated

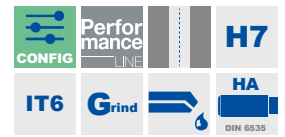
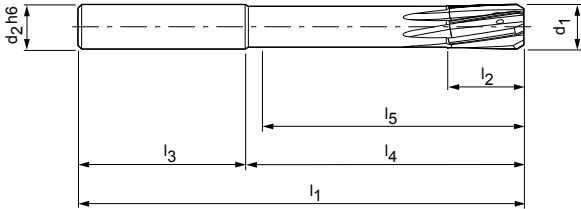

Preferred series in H7

d ₁ H7	Dimensions						z	Specification	Order no.
	d ₂ h6	l ₁	l ₂	l ₃	l ₄	l ₅			
4,000	6	75	12	36	39	34	4	FXR510Ø4.000H7MG1M-HP145	30570722
5,000	6	75	12	36	39	35	4	FXR510Ø5.000H7MG1M-HP145	30570724
6,000	6	75	12	36	39	35	4	FXR510Ø6.000H7MG1M-HP145	30570726
7,000	8	100	16	36	64	59	6	FXR510Ø7.000H7MG1M-HP145	30570728
8,000	8	100	16	36	64	60	6	FXR510Ø8.000H7MG1M-HP145	30570730
9,000	10	100	20	40	60	55	6	FXR510Ø9.000H7MG1M-HP145	30570732
10,000	10	120	20	40	80	76	6	FXR510Ø10.000H7MG1M-HP145	30570734
11,000	12	120	20	45	75	70	6	FXR510Ø11.000H7MG1M-HP145	30570736
12,000	12	120	20	45	75	71	6	FXR510Ø12.000H7MG1M-HP145	30570738
13,000	14	130	22	45	85	80	6	FXR510Ø13.000H7MG1M-HP145	30570739
14,000	14	130	22	45	85	80	6	FXR510Ø14.000H7MG1M-HP145	30570740
15,000	16	130	22	48	82	77	6	FXR510Ø15.000H7MG1M-HP145	30570741
16,000	16	150	25	48	102	97	6	FXR510Ø16.000H7MG1M-HP145	30570742
17,000	18	150	25	48	102	97	8	FXR510Ø17.000H7MG1M-HP145	30570743
18,000	18	150	25	48	102	97	8	FXR510Ø18.000H7MG1M-HP145	30570744
19,000	20	150	25	50	100	95	8	FXR510Ø19.000H7MG1M-HP145	30570745

Dimensions in mm.
For cutting data recommendations, see end of chapter.

FXR510 | Fixed design, left-hand fluted

Configurable features

**Bore diameter tolerance \geq IT6:**

- Diameter freely selectable in increments of 0.001 mm
- Can be ordered in tolerance \geq IT6

**Specification:**

FXR510Ø[diameter][tolerance]MG1M-HP145

G variants:

- Diameter freely selectable in increments of 0.001 mm
- From tolerance \geq 4 μ m orderable (G variant, see page 320)

G variant specification:

FXR510GØ[diameter][tolerance]MG1M-HP145

Dimensions of configurable series IT6

d_1	d_2	l_1	l_2	l_3	l_4	l_5	z
2,800 - 3,700	4	65	12	28	37	34	4
3,701 - 4,700	6	75	12	36	39	34	4
4,701 - 6,200	6	75	12	36	39	35	4
6,201 - 7,200	8	100	16	36	64	59	6
7,201 - 8,200	8	100	16	36	64	60	6
8,201 - 9,200	10	100	20	40	60	55	6
9,201 - 10,200	10	120	20	40	80	76	6
10,201 - 11,200	12	120	20	45	75	70	6
11,201 - 12,200	12	120	20	45	75	71	6
12,201 - 14,200	14	130	22	45	85	80	6
14,201 - 15,200	16	130	22	48	82	77	6
15,201 - 16,200	16	150	25	48	102	97	6
16,201 - 18,200	18	150	25	48	102	97	8
18,201 - 20,200	20	150	25	50	100	95	8

IT6 tolerance example:

FXR510Ø16.350H6MG1M-HP145

Bore diameter $d_1 = 16.350$ H6**G variant example:**

FXR510GØ16.350-4MG1M-HP145

Special tool diameter $d_1 = 16.350 -4 \mu$ m

FixReam

Fixed design, left-hand fluted, for through bores
FXR510

Design:

Reamer diameter:
Lead:
Cutting material:

2.800–20.200 mm
MG1M
HU612
Carbide
uncoated

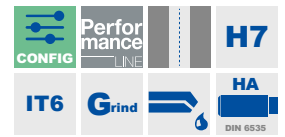
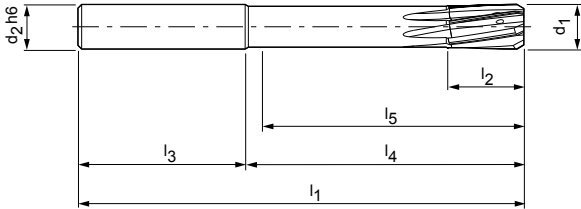

Preferred series in H7

d ₁ H7	Dimensions						z	Specification	Order no.
	d ₂ h6	l ₁	l ₂	l ₃	l ₄	l ₅			
4,000	6	75	12	36	39	34	4	FXR510Ø4.000H7MG1M-HU612	30570665
5,000	6	75	12	36	39	35	4	FXR510Ø5.000H7MG1M-HU612	30570667
6,000	6	75	12	36	39	35	4	FXR510Ø6.000H7MG1M-HU612	30570669
7,000	8	100	16	36	64	59	6	FXR510Ø7.000H7MG1M-HU612	30570671
8,000	8	100	16	36	64	60	6	FXR510Ø8.000H7MG1M-HU612	30570673
9,000	10	100	20	40	60	55	6	FXR510Ø9.000H7MG1M-HU612	30570675
10,000	10	120	20	40	80	76	6	FXR510Ø10.000H7MG1M-HU612	30570677
11,000	12	120	20	45	75	70	6	FXR510Ø11.000H7MG1M-HU612	30570679
12,000	12	120	20	45	75	71	6	FXR510Ø12.000H7MG1M-HU612	30570682
13,000	14	130	22	45	85	80	6	FXR510Ø13.000H7MG1M-HU612	30570683
14,000	14	130	22	45	85	80	6	FXR510Ø14.000H7MG1M-HU612	30570684
15,000	16	130	22	48	82	77	6	FXR510Ø15.000H7MG1M-HU612	30570685
16,000	16	150	25	48	102	97	6	FXR510Ø16.000H7MG1M-HU612	30570686
17,000	18	150	25	48	102	97	8	FXR510Ø17.000H7MG1M-HU612	30570687
18,000	18	150	25	48	102	97	8	FXR510Ø18.000H7MG1M-HU612	30570688

Dimensions in mm.
For cutting data recommendations, see end of chapter.

FXR510 | Fixed design, left-hand fluted

Configurable features

**Bore diameter tolerance \geq IT6:**

- Diameter freely selectable in increments of 0.001 mm
- Can be ordered in tolerance \geq IT6

**Specification:**

FXR510Ø[diameter][tolerance]MG1M-HU612

G variants:

- Diameter freely selectable in increments of 0.001 mm
- Can be ordered from tolerance \geq 3 μ m (G variant, see page 320)

G variant specification:

FXR510GØ[diameter][tolerance]MG1M-HU612

Dimensions of configurable series IT6

d_1	d_2	l_1	l_2	l_3	l_4	l_5	z
2,800 - 3,700	4	65	12	28	37	34	4
3,701 - 4,700	6	75	12	36	39	34	4
4,701 - 6,200	6	75	12	36	39	35	4
6,201 - 7,200	8	100	16	36	64	59	6
7,201 - 8,200	8	100	16	36	64	60	6
8,201 - 9,200	10	100	20	40	60	55	6
9,201 - 10,200	10	120	20	40	80	76	6
10,201 - 11,200	12	120	20	45	75	70	6
11,201 - 12,200	12	120	20	45	75	71	6
12,201 - 14,200	14	130	22	45	85	80	6
14,201 - 15,200	16	130	22	48	82	77	6
15,201 - 16,200	16	150	25	48	102	97	6
16,201 - 18,200	18	150	25	48	102	97	8
18,201 - 20,200	20	150	25	50	100	95	8

IT6 tolerance example:

FXR510Ø16.350H6MG1M-HU612

Bore diameter $d_1 = 16.350$ H6**G variant example:**

FXR510GØ16.350-3MG1M-HU612

Special tool diameter $d_1 = 16.350 - 3 \mu\text{m}$

FixReam

Fixed design, left-hand fluted, for through bores
FXR510

Design:

Reamer diameter:
Lead:
Cutting material:

3.701-20.200 mm
MF1M
HP145
Carbide
PVD-coated

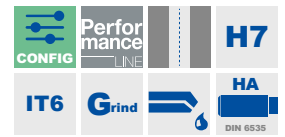
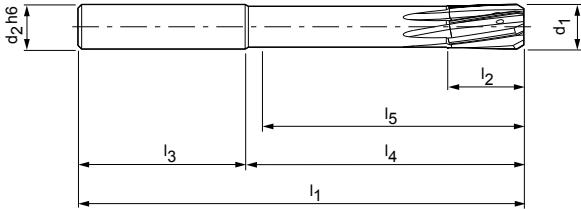

Preferred series in H7

d ₁ H7	Dimensions						z	Specification	Order no.
	d ₂ h6	l ₁	l ₂	l ₃	l ₄	l ₅			
4,000	6	75	12	36	39	35	4	FXR510Ø4.000H7MF1M-HP145	30570772
5,000	6	75	12	36	39	35	4	FXR510Ø5.000H7MF1M-HP145	30570774
6,000	6	75	12	36	39	35	4	FXR510Ø6.000H7MF1M-HP145	30570776
7,000	8	100	16	36	64	59	6	FXR510Ø7.000H7MF1M-HP145	30570778
8,000	8	100	16	36	64	60	6	FXR510Ø8.000H7MF1M-HP145	30570780
10,000	10	120	20	40	80	76	6	FXR510Ø10.000H7MF1M-HP145	30570784
11,000	12	120	20	45	75	70	6	FXR510Ø11.000H7MF1M-HP145	30570786
12,000	12	120	20	45	75	71	6	FXR510Ø12.000H7MF1M-HP145	30570788
14,000	14	130	22	45	85	80	6	FXR510Ø14.000H7MF1M-HP145	30570790
16,000	16	150	25	48	102	97	6	FXR510Ø16.000H7MF1M-HP145	30570792

Dimensions in mm.
For cutting data recommendations, see end of chapter.

FXR510 | Fixed design, left-hand fluted

Configurable features

**Bore diameter tolerance \geq IT6:**

- Diameter freely selectable in increments of 0.001 mm
- Can be ordered in tolerance \geq IT6

**Specification:**

FXR510Ø[diameter][tolerance]MF1M-HP145

G variants:

- Diameter freely selectable in increments of 0.001 mm
- From tolerance \geq 4 μ m orderable (G variant, see page 320)

G variant specification:

FXR510GØ[diameter][tolerance]MF1M-HP145

Dimensions of configurable series IT6

d ₁	d ₂	l ₁	l ₂	l ₃	l ₄	l ₅	z
3,701 - 4,700	6	75	12	36	39	34	4
4,701 - 6,200	6	75	12	36	39	35	4
6,201 - 7,200	8	100	16	36	64	59	6
7,201 - 8,200	8	100	16	36	64	60	6
8,201 - 9,200	10	100	20	40	60	55	6
9,201 - 10,200	10	120	20	40	80	76	6
10,201 - 11,200	12	120	20	45	75	70	6
11,201 - 12,200	12	120	20	45	75	71	6
12,201 - 14,200	14	130	22	45	85	80	6
14,201 - 15,200	16	130	22	48	82	77	6
15,201 - 16,200	16	150	25	48	102	97	6
16,201 - 18,200	18	150	25	48	102	97	8
18,201 - 20,200	20	150	25	50	100	95	8

IT6 tolerance example:

FXR510Ø16.350H6MF1M-HP145

Bore diameter d₁ = 16.350 H6**G variant example:**

FXR510GØ16.350-4MF1M-HP145

Special tool diameter d₁ = 16.350 -4 μ m

FixReam

Fixed design, left-hand fluted, for through bores
FXR510

Design:

Reamer diameter:
Lead:
Cutting material:

3.701-20.200 mm
MF1M
HP625
Carbide
PVD-coated

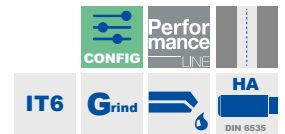
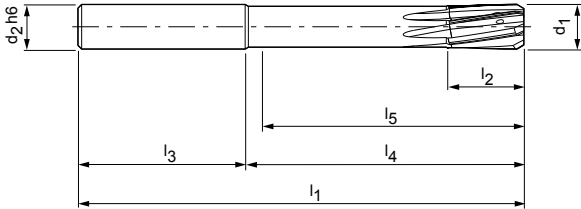

Configurable features



Bore diameter tolerance \geq IT6:
- Diameter freely selectable in increments of 0.001 mm
- Can be ordered in tolerance \geq IT6

Specification:
FXR510Ø[diameter][tolerance]MF1M-HP625

G variants:
- Diameter freely selectable in increments of 0.001 mm
- From tolerance \geq 4 μ m orderable (G variant, see page 320)

G variant specification:
FXR510GØ[diameter][tolerance]MF1M-HP625

Dimensions of configurable series IT6

d ₁	d ₂	l ₁	l ₂	l ₃	l ₄	l ₅	z
3,701 - 4,700	6	75	12	36	39	34	4
4,701 - 6,200	6	75	12	36	39	35	4
6,201 - 7,200	8	100	16	36	64	59	6
7,201 - 8,200	8	100	16	36	64	60	6
8,201 - 9,200	10	100	20	40	60	55	6
9,201 - 10,200	10	120	20	40	80	76	6
10,201 - 11,200	12	120	20	45	75	70	6
11,201 - 12,200	12	120	20	45	75	71	6
12,201 - 14,200	14	130	22	45	85	80	6
14,201 - 15,200	16	130	22	48	82	77	6
15,201 - 16,200	16	150	25	48	102	97	6
16,201 - 18,200	18	150	25	48	102	97	8
18,201 - 20,200	20	150	25	50	100	95	8

IT6 tolerance example:
FXR510Ø16.350H6MF1M-HP625

Bore diameter d₁ = 16.350 H6

G variant example:
FXR510GØ16.350-4MF1M-HP625

Special tool diameter d₁ = 16.350 -4 μ m

FixReam

Fixed design, left-hand fluted, for through bores
FXR510

Design:

Reamer diameter: 3.701–20.200 mm
Lead: MF1M
Cutting material: HC614
Carbide
CVD-coated

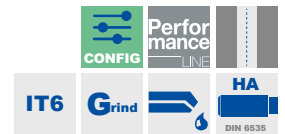
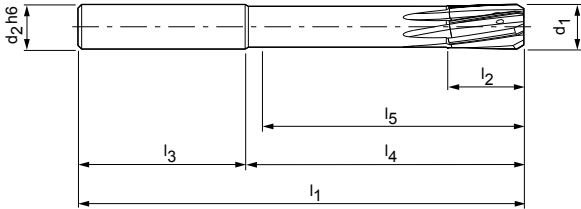

Configurable features



Bore diameter tolerance ≥ IT6:
- Diameter freely selectable in increments of 0.001 mm
- Can be ordered in tolerance ≥ IT6

Specification:
FXR510Ø[diameter][tolerance]MF1M-HC614

G variants:
- Diameter freely selectable in increments of 0.001 mm
- From tolerance ≥ 4 µm orderable (G variant, see page 320)

G variant specification:
FXR510GØ[diameter][tolerance]MF1M-HC614

Dimensions of configurable series IT6

d ₁	d ₂	l ₁	l ₂	l ₃	l ₄	l ₅	z
3,701 - 4,700	6	75	12	36	39	34	4
4,701 - 6,200	6	75	12	36	39	35	4
6,201 - 7,200	8	100	16	36	64	59	6
7,201 - 8,200	8	100	16	36	64	60	6
8,201 - 9,200	10	100	20	40	60	55	6
9,201 - 10,200	10	120	20	40	80	76	6
10,201 - 11,200	12	120	20	45	75	70	6
11,201 - 12,200	12	120	20	45	75	71	6
12,201 - 14,200	14	130	22	45	85	80	6
14,201 - 15,200	16	130	22	48	82	77	6
15,201 - 16,200	16	150	25	48	102	97	6
16,201 - 18,200	18	150	25	48	102	97	8
18,201 - 20,200	20	150	25	50	100	95	8

IT6 tolerance example:
FXR510Ø16.350H6MF1M-HC614

Bore diameter d₁ = 16.350 H6

G variant example:
FXR510GØ16.350-4MF1M-HC614

Special tool diameter d₁ = 16.350 -4 µm

Dimensions in mm.
For cutting data recommendations, see end of chapter.

FixReam

Fixed design, straight fluted, for through bores
FXR500

Design:

Reamer diameter:
Lead:
Cutting material:

3.701-20.200 mm
MG0A
HP622
Carbide
PVD-coated

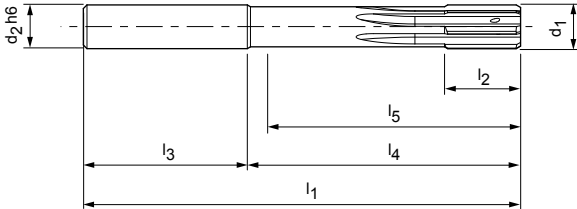

Configurable features



Bore diameter tolerance ≥ IT6:
- Diameter freely selectable in increments of 0.001 mm
- Can be ordered in tolerance ≥ IT6

Specification:
FXR500Ø[diameter][tolerance]MG0A-HP622

G variants:
- Diameter freely selectable in increments of 0.001 mm
- From tolerance ≥ 4 µm orderable (G variant, see page 320)

G variant specification:
FXR500GØ[diameter][tolerance]MG0A-HP622

Dimensions of configurable series IT6

d ₁	d ₂	l ₁	l ₂	l ₃	l ₄	l ₅	z
3,701 - 4,700	6	75	12	36	39	34	4
4,701 - 6,200	6	75	12	36	39	35	4
6,201 - 7,200	8	100	16	36	64	59	6
7,201 - 8,200	8	100	16	36	64	60	6
8,201 - 9,200	10	100	20	40	60	55	6
9,201 - 10,200	10	120	20	40	80	76	6
10,201 - 11,200	12	120	20	45	75	70	6
11,201 - 12,200	12	120	20	45	75	71	6
12,201 - 14,200	14	130	22	45	85	80	6
14,201 - 15,200	16	130	22	48	82	77	6
15,201 - 16,200	16	150	25	48	102	97	6
16,201 - 18,200	18	150	25	48	102	97	8
18,201 - 20,200	20	150	25	50	100	95	8

IT6 tolerance example:
FXR500Ø16.350H6MG0A-HP622

Bore diameter d₁ = 16.350 H6

G variant example:
FXR500GØ16.350-4MG0A-HP622

Special tool diameter d₁ = 16.350 -4 µm

FixReam

Fixed design, straight fluted, for through bores
FXR500

Design:

Reamer diameter: 3.701–20.200 mm
Lead: MF0A
Cutting material: HP141
Carbide
PVD-coated

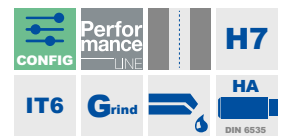
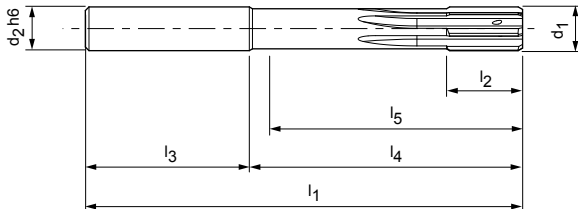

Preferred series in H7

d ₁ H7	Dimensions						z	Specification	Order no.
	d ₂ h6	l ₁	l ₂	l ₃	l ₄	l ₅			
5,000	6	75	12	36	39	35	4	FXR500Ø5.000H7MF0A-HP141	30570824
6,000	6	75	12	36	39	35	4	FXR500Ø6.000H7MF0A-HP141	30570826
8,000	8	100	16	36	64	60	6	FXR500Ø8.000H7MF0A-HP141	30570830
10,000	10	120	20	40	80	76	6	FXR500Ø10.000H7MF0A-HP141	30570834
12,000	12	120	20	45	75	71	6	FXR500Ø12.000H7MF0A-HP141	30570838

Configurable features



Bore diameter tolerance ≥ IT6:

- Diameter freely selectable in increments of 0.001 mm
- Can be ordered in tolerance ≥ IT6

Specification:

FXR500Ø[diameter][tolerance]MF0A-HP141

G variants:

- Diameter freely selectable in increments of 0.001 mm
- Can be ordered from tolerance ≥ 5 μm (G variant, see page 320)

G variant specification:

FXR500GØ[diameter][tolerance]MF0A-HP141

Dimensions of configurable series IT6

d ₁	d ₂	l ₁	l ₂	l ₃	l ₄	l ₅	z
3,701 - 4,700	6	75	12	36	39	34	4
4,701 - 6,200	6	75	12	36	39	35	4
6,201 - 7,200	8	100	16	36	64	59	6
7,201 - 8,200	8	100	16	36	64	60	6
8,201 - 9,200	10	100	20	40	60	55	6
9,201 - 10,200	10	120	20	40	80	76	6
10,201 - 11,200	12	120	20	45	75	70	6
11,201 - 12,200	12	120	20	45	75	71	6
12,201 - 14,200	14	130	22	45	85	80	6
14,201 - 15,200	16	130	22	48	82	77	6
15,201 - 16,200	16	150	25	48	102	97	6
16,201 - 18,200	18	150	25	48	102	97	8
18,201 - 20,200	20	150	25	50	100	95	8

IT6 tolerance example:

FXR500Ø16.350H6MF0A-HP141

Bore diameter d₁ = 16.350 H6

G variant example:

FXR500GØ16.350-5MF0A-HP141

Special tool diameter d₁ = 16.350 -5 μm

Dimensions in mm.

For cutting data recommendations, see end of chapter.

FixReam

Fixed design, straight fluted, for blind bores
FXR505

Design:

Reamer diameter:
Lead:
Cutting material:

2.800–20.200 mm
MV0A
HP145
Carbide
PVD-coated

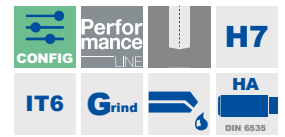
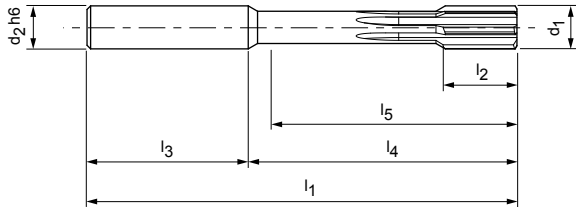

Preferred series in H7

d ₁ H7	Dimensions						z	Specification	Order no.
	d ₂ h6	l ₁	l ₂	l ₃	l ₄	l ₅			
4,000	6	75	12	36	39	34	4	FXR505Ø4.000H7MV0A-HP145	30570747
5,000	6	75	12	36	39	34	4	FXR505Ø5.000H7MV0A-HP145	30570749
6,000	6	75	12	36	39	34	4	FXR505Ø6.000H7MV0A-HP145	30570751
7,000	8	100	16	36	64	58	6	FXR505Ø7.000H7MV0A-HP145	30570753
8,000	8	100	16	36	64	58	6	FXR505Ø8.000H7MV0A-HP145	30570755
9,000	10	100	20	40	60	54	6	FXR505Ø9.000H7MV0A-HP145	30570757
10,000	10	120	20	40	80	74	6	FXR505Ø10.000H7MV0A-HP145	30570759
11,000	12	120	20	45	75	68	6	FXR505Ø11.000H7MV0A-HP145	30570761
12,000	12	120	20	45	75	68	6	FXR505Ø12.000H7MV0A-HP145	30570763
13,000	14	130	22	45	85	78	6	FXR505Ø13.000H7MV0A-HP145	30570764
14,000	14	130	22	45	85	78	6	FXR505Ø14.000H7MV0A-HP145	30570765
15,000	16	130	22	48	82	75	6	FXR505Ø15.000H7MV0A-HP145	30570766
16,000	16	150	25	48	102	95	6	FXR505Ø16.000H7MV0A-HP145	30570767
17,000	18	150	25	48	102	95	6	FXR505Ø17.000H7MV0A-HP145	30570768
18,000	18	150	25	48	102	95	6	FXR505Ø18.000H7MV0A-HP145	30570769
19,000	20	150	25	50	100	92	6	FXR505Ø19.000H7MV0A-HP145	30570770

Dimensions in mm.

For cutting data recommendations, see end of chapter.

FXR505 | Fixed design, straight fluted

Configurable features

**Bore diameter tolerance \geq IT6:**

- Diameter freely selectable in increments of 0.001 mm
- Can be ordered in tolerance \geq IT6

**Specification:**

FXR505Ø[diameter][tolerance]MV0A-HP145

G variants:

- Diameter freely selectable in increments of 0.001 mm
- From tolerance \geq 4 μ m orderable (G variant, see page 320)

G variant specification:

FXR505GØ[diameter][tolerance]MV0A-HP145

Dimensions of configurable series IT6

d ₁	d ₂	l ₁	l ₂	l ₃	l ₄	l ₅	z
2,800 - 3,350	4	65	12	37	28	33	4
3,351 - 3,700	4	65	12	28	37	33	4
3,701 - 6,200	6	75	12	36	39	34	4
6,201 - 8,200	8	100	16	36	64	58	6
8,201 - 9,200	10	100	20	40	60	54	6
9,201 - 10,200	10	120	20	40	80	74	6
10,201 - 12,200	12	120	20	45	75	68	6
12,201 - 14,200	14	130	22	45	85	78	6
14,201 - 15,200	16	130	22	48	82	75	6
15,201 - 16,200	16	150	25	48	102	95	6
16,201 - 18,200	18	150	25	48	102	95	6
18,201 - 20,200	20	150	25	50	100	92	6

IT6 tolerance example:

FXR505Ø16.350H6MV0A-HP145

Bore diameter d₁ = 16.350 H6**G variant example:**

FXR505GØ16.350-4MV0A-HP145

Special tool diameter d₁ = 16.350 -4 μ m

FixReam

Fixed design, straight fluted, for blind bores
FXR505

Design:

Reamer diameter: 3.701-20.200 mm
Lead: MTOA
Cutting material: HP145 Carbide
PVD-coated

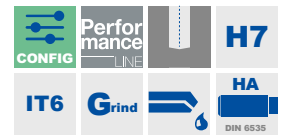
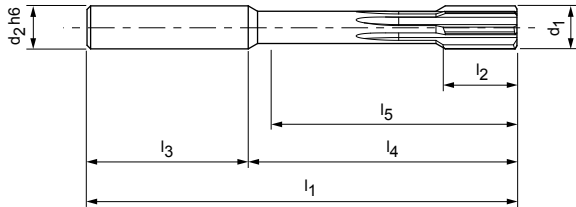

Preferred series in H7

d ₁ H7	Dimensions						z	Specification	Order no.
	d ₂ h6	l ₁	l ₂	l ₃	l ₄	l ₅			
4,000	6	75	12	36	39	34	4	FXR505Ø4.000H7MTOA-HP145	30570797
5,000	6	75	12	36	39	34	4	FXR505Ø5.000H7MTOA-HP145	30570799
6,000	6	75	12	36	39	34	4	FXR505Ø6.000H7MTOA-HP145	30570801
8,000	8	100	16	36	64	58	6	FXR505Ø8.000H7MTOA-HP145	30570805
10,000	10	120	20	40	80	74	6	FXR505Ø10.000H7MTOA-HP145	30570809
12,000	12	120	20	45	75	68	6	FXR505Ø12.000H7MTOA-HP145	30570813

Configurable features



Bore diameter tolerance ≥ IT6:
- Diameter freely selectable in increments of 0.001 mm
- Can be ordered in tolerance ≥ IT6

Specification:
FXR505Ø[diameter][tolerance]MTOA-HP145

G variants:
- Diameter freely selectable in increments of 0.001 mm
- From tolerance ≥ 4 µm orderable (G variant, see page 320)

G variant specification:
FXR505GØ[diameter][tolerance]MTOA-HP145

Dimensions of configurable series IT6

d ₁	d ₂	l ₁	l ₂	l ₃	l ₄	l ₅	z
3,701 - 6,200	6	75	12	36	39	34	4
6,201 - 8,200	8	100	16	36	64	58	6
8,201 - 9,200	10	100	20	40	60	54	6
9,201 - 10,200	10	120	20	40	80	74	6
10,201 - 12,200	12	120	20	45	75	68	6
12,201 - 14,200	14	130	22	45	85	78	6
14,201 - 15,200	16	130	22	48	82	75	6
15,201 - 16,200	16	150	25	48	102	95	6
16,201 - 18,200	18	150	25	48	102	95	6
18,201 - 20,200	20	150	25	50	100	92	6

IT6 tolerance example:
FXR505Ø16.350H6MTOA-HP145

Bore diameter d₁ = 16.350 H6

G variant example:
FXR505GØ16.350-4MTOA-HP145

Special tool diameter d₁ = 16.350 -4 µm

Dimensions in mm.
For cutting data recommendations, see end of chapter.

FixReam

Fixed design, straight fluted, for blind bores
FXR505

Design:
Reamer diameter: 3.701-20.200 mm
Lead: MVOA
Cutting material: HP622
Carbide
PVD-coated

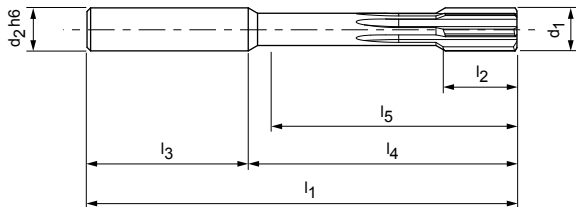

Configurable features



Bore diameter tolerance \geq IT6:
- Diameter freely selectable in increments of 0.001 mm
- Can be ordered in tolerance \geq IT6

Specification:
FXR505Ø[diameter][tolerance]MVOA-HP622

G variants:
- Diameter freely selectable in increments of 0.001 mm
- From tolerance \geq 4 μ m orderable (G variant, see page 320)

G variant specification:
FXR505GØ[diameter][tolerance]MVOA-HP622

Dimensions of configurable series IT6

d ₁	d ₂	l ₁	l ₂	l ₃	l ₄	l ₅	z
3,701 - 6,200	6	75	12	36	39	34	4
6,201 - 8,200	8	100	16	36	64	58	6
8,201 - 9,200	10	100	20	40	60	54	6
9,201 - 10,200	10	120	20	40	80	74	6
10,201 - 12,200	12	120	20	45	75	68	6
12,201 - 14,200	14	130	22	45	85	78	6
14,201 - 15,200	16	130	22	48	82	75	6
15,201 - 16,200	16	150	25	48	102	95	6
16,201 - 18,200	18	150	25	48	102	95	6
18,201 - 20,200	20	150	25	50	100	92	6

IT6 tolerance example:
FXR505Ø16.350H6MVOA-HP622

Bore diameter d₁ = 16.350 H6

G variant example:
FXR505GØ16.350-4MVOA-HP622

Special tool diameter d₁ = 16.350 -4 μ m

FixReam

Fixed design, straight fluted, for blind bores
FXR505

Design:

Reamer diameter:
Lead:
Cutting material:

2.800-20.200 mm
MV0A
HU612
Carbide
uncoated

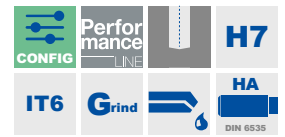
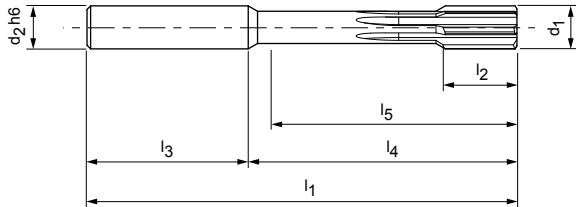

Preferred series in H7

d ₁ H7	Dimensions						z	Specification	Order no.
	d ₂ h6	l ₁	l ₂	l ₃	l ₄	l ₅			
4,000	6	75	12	36	39	34	4	FXR505Ø4.000H7MV0A-HU612	30570694
5,000	6	75	12	36	39	34	4	FXR505Ø5.000H7MV0A-HU612	30570696
6,000	6	75	12	36	39	34	4	FXR505Ø6.000H7MV0A-HU612	30570698
7,000	8	100	16	36	64	58	6	FXR505Ø7.000H7MV0A-HU612	30570700
8,000	8	100	16	36	64	58	6	FXR505Ø8.000H7MV0A-HU612	30570702
9,000	10	100	20	40	60	54	6	FXR505Ø9.000H7MV0A-HU612	30570704
10,000	10	120	20	40	80	74	6	FXR505Ø10.000H7MV0A-HU612	30570706
12,000	12	120	20	45	75	68	6	FXR505Ø12.000H7MV0A-HU612	30570710
13,000	14	130	22	45	85	78	6	FXR505Ø13.000H7MV0A-HU612	30570711
14,000	14	130	22	45	85	78	6	FXR505Ø14.000H7MV0A-HU612	30570712
15,000	16	130	22	48	82	75	6	FXR505Ø15.000H7MV0A-HU612	30570713
16,000	16	150	25	48	102	95	6	FXR505Ø16.000H7MV0A-HU612	30570714
18,000	18	150	25	48	102	95	6	FXR505Ø18.000H7MV0A-HU612	30570716
19,000	20	150	25	50	100	92	6	FXR505Ø19.000H7MV0A-HU612	30570717

Dimensions in mm.

For cutting data recommendations, see end of chapter.

FXR505 | Fixed design, straight fluted

Configurable features

**Bore diameter tolerance \geq IT6:**

- Diameter freely selectable in increments of 0.001 mm
- Can be ordered in tolerance \geq IT6

**Specification:**

FXR505Ø[diameter][tolerance]MV0A-HU612

G variants:

- Diameter freely selectable in increments of 0.001 mm
- Can be ordered from tolerance \geq 3 μ m (G variant, see page 320)

G variant specification:

FXR505GØ[diameter][tolerance]MV0A-HU612

Dimensions of configurable series IT6

d_1	d_2	l_1	l_2	l_3	l_4	l_5	z
2,800 - 3,350	4	65	12	37	28	33	4
3,351 - 3,700	4	65	12	28	37	33	4
3,701 - 6,200	6	75	12	36	39	34	4
6,201 - 8,200	8	100	16	36	64	58	6
8,201 - 9,200	10	100	20	40	60	54	6
9,201 - 10,200	10	120	20	40	80	74	6
10,201 - 12,200	12	120	20	45	75	68	6
12,201 - 14,200	14	130	22	45	85	78	6
14,201 - 15,200	16	130	22	48	82	75	6
15,201 - 16,200	16	150	25	48	102	95	6
16,201 - 18,200	18	150	25	48	102	95	6
18,201 - 20,200	20	150	25	50	100	92	6

IT6 tolerance example:

FXR505Ø16.350H6MV0A-HU612

Bore diameter $d_1 = 16.350$ H6**G variant example:**

FXR505GØ16.350-3MV0A-HU612

Special tool diameter $d_1 = 16.350 - 3 \mu$ m

FixReam

Fixed design, straight fluted, for blind bores
FXR505

Design:

Reamer diameter:
Lead:
Cutting material:

3.701-20.200 mm
MT0A
HP625
Carbide
PVD-coated

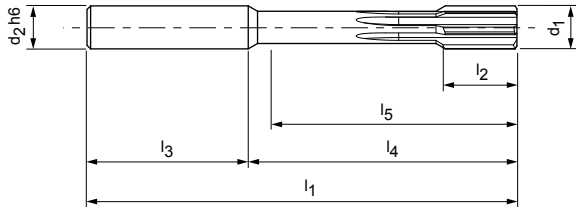

Configurable features



Bore diameter tolerance ≥ IT6:
- Diameter freely selectable in increments of 0.001 mm
- Can be ordered in tolerance ≥ IT6

Specification:
FXR505Ø[diameter][tolerance]MT0A-HP625

G variants:
- Diameter freely selectable in increments of 0.001 mm
- From tolerance ≥ 4 µm orderable (G variant, see page 320)

G variant specification:
FXR505GØ[diameter][tolerance]MT0A-HP625

Dimensions of configurable series IT6

d ₁	d ₂	l ₁	l ₂	l ₃	l ₄	l ₅	z
3,701 - 6,200	6	75	12	36	39	34	4
6,201 - 8,200	8	100	16	36	64	58	6
8,201 - 9,200	10	100	20	40	60	54	6
9,201 - 10,200	10	120	20	40	80	74	6
10,201 - 12,200	12	120	20	45	75	68	6
12,201 - 14,200	14	130	22	45	85	78	6
14,201 - 15,200	16	130	22	48	82	75	6
15,201 - 16,200	16	150	25	48	102	95	6
16,201 - 18,200	18	150	25	48	102	95	6
18,201 - 20,200	20	150	25	50	100	92	6

IT6 tolerance example:
FXR505Ø16.350H6MT0A-HP625

Bore diameter d₁ = 16.350 H6

G variant example:
FXR505GØ16.350-4MT0A-HP625

Special tool diameter d₁ = 16.350 -4 µm

FixReam

Fixed design, straight fluted, for blind bores
FXR505

Design:

Reamer diameter:

3.701–20.200 mm

Lead:

MVOA

Cutting material:

HC614

Carbide

CVD-coated

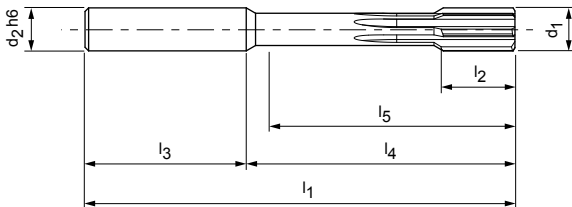

Configurable features

Bore diameter tolerance \geq IT6:

- Diameter freely selectable in increments of 0.001 mm
- Can be ordered in tolerance \geq IT6

Specification:

FXR505Ø[diameter][tolerance]MVOA-HC614

G variants:

- Diameter freely selectable in increments of 0.001 mm
- From tolerance \geq 4 μ m orderable (G variant, see page 320)

G variant specification:

FXR505GØ[diameter][tolerance]MVOA-HC614

Dimensions of configurable series IT6

d ₁	d ₂	l ₁	l ₂	l ₃	l ₄	l ₅	z
3,701 - 6,200	6	75	12	36	39	34	4
6,201 - 8,200	8	100	16	36	64	58	6
8,201 - 9,200	10	100	20	40	60	54	6
9,201 - 10,200	10	120	20	40	80	74	6
10,201 - 12,200	12	120	20	45	75	68	6
12,201 - 14,200	14	130	22	45	85	78	6
14,201 - 15,200	16	130	22	48	82	75	6
15,201 - 16,200	16	150	25	48	102	95	6
16,201 - 18,200	18	150	25	48	102	95	6
18,201 - 20,200	20	150	25	50	100	92	6

IT6 tolerance example:

FXR505Ø16.350H6MVOA-HC614

Bore diameter d₁ = 16.350 H6

G variant example:

FXR505GØ16.350-4MVOA-HC614

Special tool diameter d₁ = 16.350 -4 μ m

Dimensions in mm.

For cutting data recommendations, see end of chapter.

FixReam

Fixed design, straight fluted, for blind bores
FXR505

Design:

Reamer diameter:
Lead:
Cutting material:

3.701-20.200 mm
MT0A
HP141
Carbide
PVD-coated

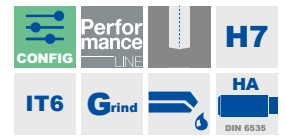
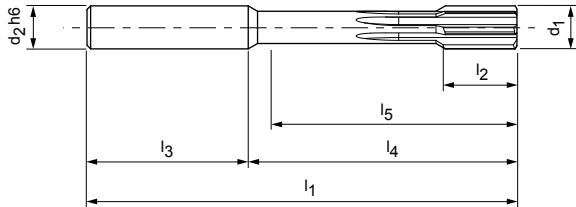

Configurable features



Bore diameter tolerance \geq IT6:
- Diameter freely selectable in increments of 0.001 mm
- Can be ordered in tolerance \geq IT6

Specification:
FXR505Ø[diameter][tolerance]MT0A-HP141

G variants:
- Diameter freely selectable in increments of 0.001 mm
- Can be ordered from tolerance \geq 5 μ m (G variant, see page 320)

G variant specification:
FXR505GØ[diameter][tolerance]MT0A-HP141

Dimensions of configurable series IT6

d_1	d_2	l_1	l_2	l_3	l_4	l_5	z
3,701 - 6,200	6	75	12	36	39	34	4
6,201 - 8,200	8	100	16	36	64	58	6
8,201 - 9,200	10	100	20	40	60	54	6
9,201 - 10,200	10	120	20	40	80	74	6
10,201 - 12,200	12	120	20	45	75	68	6
12,201 - 14,200	14	130	22	45	85	78	6
14,201 - 15,200	16	130	22	48	82	75	6
15,201 - 16,200	16	150	25	48	102	95	6
16,201 - 18,200	18	150	25	48	102	95	6
18,201 - 20,200	20	150	25	50	100	92	6

IT6 tolerance example:
FXR505Ø16.350H6MT0A-HP141

Bore diameter $d_1 = 16.350$ H6

G variant example:
FXR505GØ16.350-5MT0A-HP141

Special tool diameter $d_1 = 16.350 -5 \mu$ m

FixReam

Fixed design, straight fluted, for blind bores
FXR503-short

Design:

Reamer diameter:
Lead:
Cutting material:

2.800-20.100 mm
MC1F
HP145
Carbide
PVD-coated

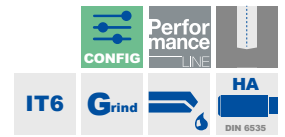
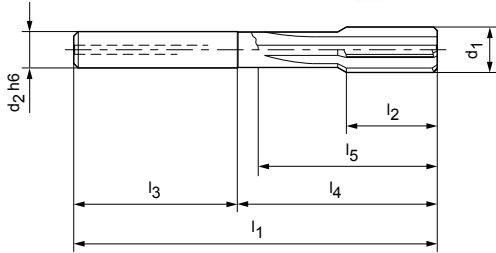

Configurable features



Bore diameter tolerance ≥ IT6:
- Diameter freely selectable in increments of 0.001 mm
- Can be ordered in tolerance ≥ IT6

Specification:
FXR503Ø[diameter][tolerance]MC1F-HP145

G variants:
- Diameter freely selectable in increments of 0.001 mm
- From tolerance ≥ 4 µm orderable (G variant, see page 320)

G variant specification:
FXR503GØ[diameter][tolerance]MC1F-HP145

Dimensions of configurable series IT6

d ₁	d ₂	l ₁	l ₂	l ₃	l ₄	l ₅	z
2,800 - 4,050	4	56	12	28	28	24	4
4,051 - 5,100	6	64	12	36	28	23	4
5,101 - 5,600	6	64	12	36	28	24	4
6,101 - 6,600	8	75	16	36	39	32	6
6,601 - 7,100	8	75	16	36	39	34	6
7,101 - 8,100	8	75	16	36	39	35	6
8,101 - 10,100	8	75	20	36	39	35	6
10,101 - 11,600	10	80	20	40	40	35	6
11,601 - 13,100	12	90	22	45	45	40	6
13,101 - 15,100	14	90	22	45	45	40	6
15,101 - 18,100	16	100	25	48	52	47	8
18,101 - 20,100	18	100	25	48	52	47	8

IT6 tolerance example:
FXR503Ø16.350H6MC1F-HP145

Bore diameter d₁ = 16.350 H6

G variant example:
FXR503GØ16.350-4MC1F-HP145

Special tool diameter d₁ = 16.350 -4 µm



Cutting data recommendations for FixReam FXR

Feed and cutting speed

FXR510 | FXR505

Cutting material: HP145 | Lead: MF1M | MTOA

MMG*		Workpiece material	Strength/hardness [N/mm ²] [HRC]	Cutting speed v _c (m/min)			
				Internal cooling	External cooling	MQL	
P	P4	P4.1	Stainless steels, ferritic and martensitic	40	20	30	
	P6	P6.1	Stainless cast steel, ferritic and martensitic	40	20	30	
M	M1	M1.1	Stainless steels, austenitic	< 700	40	20	30
		M1.2	Stainless steels, ferritic/austenitic (duplex)	< 1000	30	15	20
	M2	M2.1	Stainless/heat-resistant cast steel, austenitic	< 700	40	20	30
	M3	M3.1	Stainless cast steel, ferritic/austenitic (duplex)	< 1000	30	15	20

FXR510 | FXR505

Cutting material: HP145 | Lead: MG1M | MVOA

MMG*		Workpiece material	Strength/hardness [N/mm ²] [HRC]	Cutting speed v _c (m/min)			
				Internal cooling	External cooling	MQL	
P	P1	P1.1	Structural, free-cutting, case hardened and heat-treated steels, non-alloy	< 700	180	90	150
		P1.2	Structural, free-cutting, case hardened and heat-treated steels, non-alloy	< 1200	140	70	115
	P2	P2.1	Nitrided, case hardened and heat-treated steels, alloy	< 900	180	90	150
		P2.2	Nitrided, case hardened and heat-treated steels, alloy	< 1400	140	70	115
	P3	P3.1	Tool, bearing, spring and high-speed steels**	< 800	180	90	150
		P3.2	Tool, bearing, spring and high-speed steels**	< 1000	140	70	110
		P3.3	Tool, bearing, spring and high-speed steels**	< 1500	120	60	90
P6	P5.1	Cast steel		140	75	100	
K	K1	K1.1	Cast iron with lamellar graphite (grey cast iron), GJL	< 300	120	100	100
		K2.1	Cast iron with spheroidal graphite, GJS	< 500	150	105	130
	K2	K2.2	Cast iron with spheroidal graphite, GJS	≤ 800	120	85	98
		K2.3	Cast iron with spheroidal graphite, GJS	> 800	90	55	70
	K3	K3.1	Cast iron with spheroidal graphite, GJV; malleable cast iron, GJM	< 500	90	55	70
		K3.2	Cast iron with spheroidal graphite, GJV; malleable cast iron, GJM	> 500	90	55	70

* MAPAL machining groups

** If the alloy parts Cr, Mo, Ni, V, W in total > 8% then select the next highest MAPAL machining group.

	Feed f_z (mm/z) with tool diameter						
	z 4	z 4	z 6	z 6	z 6	z 6	z 8
	< 5.000	> 5.000 - 6.200	> 6.200 - 8.000	> 8.000 - 12.000	> 12.000 - 16.000	> 16.000 - 16.200	> 16.200 - 20.200
	0.020	0.040	0.060	0.080	0.100	0.120	0.120
	0.020	0.040	0.060	0.080	0.100	0.120	0.120
	0.020	0.040	0.060	0.080	0.100	0.120	0.120
	0.020	0.040	0.060	0.080	0.100	0.120	0.120
	0.020	0.040	0.060	0.080	0.100	0.120	0.120
	0.020	0.040	0.060	0.080	0.100	0.120	0.120

	Feed f_z (mm/z) with tool diameter						
	z 4	z 4	z 6	z 6	z 6	z 6	z 8
	< 5.000	> 5.000 - 6.200	> 6.200 - 8.000	> 8.000 - 12.000	> 12.000 - 16.000	> 16.000 - 16.200	> 16.200 - 20.200
	0.050	0.080	0.080	0.140	0.180	0.180	0.190
	0.050	0.080	0.080	0.140	0.180	0.180	0.190
	0.050	0.080	0.080	0.140	0.180	0.180	0.190
	0.050	0.080	0.080	0.140	0.180	0.180	0.190
	0.050	0.080	0.080	0.140	0.180	0.180	0.190
	0.050	0.080	0.080	0.140	0.180	0.180	0.190
	0.050	0.080	0.080	0.140	0.180	0.180	0.190
	0.080	0.100	0.100	0.170	0.220	0.220	0.230
	0.080	0.100	0.100	0.170	0.220	0.220	0.230
	0.080	0.100	0.100	0.170	0.220	0.220	0.230
	0.080	0.100	0.100	0.170	0.220	0.220	0.230
	0.080	0.100	0.100	0.170	0.220	0.220	0.230
	0.080	0.100	0.100	0.170	0.220	0.220	0.230

The specified cutting values are guide values.

The optimum data for the respective machining task should be determined during the test or machining.

Cutting data recommendations for FixReam FXR

Feed and cutting speed

FXR503–short

Cutting material: HP145 | Lead: MC1F

MMG*	Workpiece material	Strength/hardness [N/mm ²] [HRC]	Cutting speed v _c (m/min)			
			Internal cooling	External cooling	MQL	
P	P1.1	Structural, free-cutting, case hardened and heat-treated steels, non-alloy	< 700	180	90	150
	P1.2	Structural, free-cutting, case hardened and heat-treated steels, non-alloy	< 1200	140	70	115
	P2.1	Nitrided, case hardened and heat-treated steels, alloy	< 900	180	90	150
	P2.2	Nitrided, case hardened and heat-treated steels, alloy	< 1400	140	70	115
	P3.1	Tool, bearing, spring and high-speed steels**	< 800	180	90	150
	P3.2	Tool, bearing, spring and high-speed steels**	< 1000	140	70	110
	P3.3	Tool, bearing, spring and high-speed steels**	< 1500	120	60	90
	P6	P5.1	Cast steel		140	75
K	K1.1	Cast iron with lamellar graphite (grey cast iron), GJL	< 300	120	100	100
	K2.1	Cast iron with spheroidal graphite, GJS	< 500	150	105	130
	K2.2	Cast iron with spheroidal graphite, GJS	≤ 800	120	85	98
	K2.3	Cast iron with spheroidal graphite, GJS	> 800	90	55	70
	K3.1	Cast iron with spheroidal graphite, GJV; malleable cast iron, GJM	< 500	90	55	70
	K3.2	Cast iron with spheroidal graphite, GJV; malleable cast iron, GJM	> 500	90	55	70

FXR505 | FXR500

Cutting material: HP622 | Lead: MVOA | MGOA

MMG*	Workpiece material	Strength/hardness [N/mm ²] [HRC]	Cutting speed v _c (m/min)			
			Internal cooling	External cooling	MQL	
N	N1.1	Aluminium, non-alloy and alloy < 3 % Si		250	125	190
	N1.2	Aluminium, alloy ≤ 7 % Si		250	125	190
	N1.3	Aluminium, alloy > 7-12 % Si		250	125	190
	N1.4	Aluminium, alloy > 12 % Si		250	125	190

FXR505 | FXR510

Cutting material: HU612 | Lead: MVOA | MG1M

MMG*	Workpiece material	Strength/hardness [N/mm ²] [HRC]	Cutting speed v _c (m/min)			
			Internal cooling	External cooling	MQL	
N2	N2.1	Copper, unalloyed and low-alloyed	< 300	50	25	
	N2.2	Copper, alloy	> 300	50	25	
	N2.3	Brass, bronze, gunmetal	< 1200	50	25	40

* MAPAL machining groups

** If the alloy parts Cr, Mo, Ni, V, W in total > 8% then select the next highest MAPAL machining group.

	Feed f_z (mm/z) with tool diameter						
	z 4	z 4	z 6	z 6	z 6	z 8	z 8
	< 5.000	> 5.000 - 6.100	> 6.100 - 8.000	> 8.000 - 12.000	> 12.000 - 15.100	> 15.100 - 16.000	> 16.000 - 20.100
	0.050	0.080	0.080	0.140	0.180	0.180	0.190
	0.050	0.080	0.080	0.140	0.180	0.180	0.190
	0.050	0.080	0.080	0.140	0.180	0.180	0.190
	0.050	0.080	0.080	0.140	0.180	0.180	0.190
	0.050	0.080	0.080	0.140	0.180	0.180	0.190
	0.050	0.080	0.080	0.140	0.180	0.180	0.190
	0.050	0.080	0.080	0.140	0.180	0.180	0.190
	0.050	0.080	0.080	0.140	0.180	0.180	0.190
	0.08	0.10	0.10	0.17	0.22	0.22	0.23
	0.08	0.10	0.10	0.17	0.22	0.22	0.23
	0.08	0.10	0.10	0.17	0.22	0.22	0.23
	0.08	0.10	0.10	0.17	0.22	0.22	0.23
	0.08	0.10	0.10	0.17	0.22	0.22	0.23
	0.08	0.10	0.10	0.17	0.22	0.22	0.23

	Feed f_z (mm/z) with tool diameter						
	z 4	z 4	z 6	z 6	z 6	z 6	z 6
	< 5.000	> 5.000 - 6.200	> 6.200 - 8.000	> 8.000 - 12.000	> 12.000 - 16.000	> 16.000 - 16.200	> 16.200 - 20.200
	0.120	0.150	0.150	0.210	0.250	0.250	0.300
	0.120	0.150	0.150	0.210	0.250	0.250	0.300
	0.120	0.150	0.150	0.210	0.250	0.250	0.300
	0.120	0.150	0.150	0.210	0.250	0.250	0.300

	Feed f_z (mm/z) with tool diameter						
	z 4	z 4	z 6	z 6	z 6	z 6	z 8
	< 5.000	> 5.000 - 6.200	> 6.200 - 8.000	> 8.000 - 12.000	> 12.000 - 16.000	> 16.000 - 16.200	> 16.200 - 20.200
	0.040	0.050	0.050	0.060	0.100	0.100	0.100
	0.040	0.050	0.050	0.060	0.100	0.100	0.100
	0.040	0.050	0.050	0.060	0.100	0.100	0.100

The specified cutting values are guide values.

The optimum data for the respective machining task should be determined during the test or machining.

Cutting data recommendations for FixReam FXR

Feed and cutting speed

FXR510 | FXR505

Cutting material: HP625 | Lead: MF1M | MTOA

MMG*		Workpiece material	Strength/hardness [N/mm ²] [HRC]	Cutting speed v _c (m/min)			
				Internal cooling	External cooling	MQL	
S	S1	S1.1	Titanium, titanium alloys	< 400	25	10	15
	S2	S2.1	Titanium, titanium alloys	< 1200	25	10	15
		S2.2	Titanium, titanium alloys	> 1200	25	10	15
	S3	S3.1	Nickel, non-alloy and alloy	< 900	25	10	15
		S3.2	Nickel, non-alloy and alloy	> 900	25	10	15
	S4	S4.1	High-temperature super alloy Ni, Co and Fe-based		25	10	15
	S5	S5.1	Tungsten and molybdenum alloys		25	10	15

FXR510 | FXR505

Cutting material: HC614 | Lead: MF1M | MVOA

MMG*		Workpiece material	Strength/hardness [N/mm ²] [HRC]	Cutting speed v _c (m/min)			
				Internal cooling	External cooling	MQL	
C	C1	C1.1	Plastic matrix, aramide fibre-reinforced (AFRP)		50	25	30
		C1.2	Plastic matrix (thermosetting), CFRP/GFRP		50	25	30
		C1.3	Plastic matrix (thermoplastic), CFRP/GFRP		50	25	30

FXR500 | FXR505

Cutting material: HP141 | Lead: MFOA | MTOA

MMG*		Workpiece material	Strength/hardness [N/mm ²] [HRC]	Cutting speed v _c (m/min)			
				Internal cooling	External cooling	MQL	
H	H1	H1.1	Hardened steel / cast steel	< 44	50	20	30
		H1.2	Hardened steel / cast steel	< 55	10	5	5

	Feed f_z (mm/z) with tool diameter						
	z 4	z 4	z 6	z 6	z 6	z 6	z 8
	< 5.000	> 5.000 - 6.200	> 6.200 - 8.000	> 8.000 - 12.000	> 12.000 - 16.000	> 16.000 - 16.200	> 16.200 - 20.200
	0.020	0.040	0.060	0.080	0.100	0.100	0.100
	0.020	0.040	0.060	0.080	0.100	0.100	0.100
	0.020	0.040	0.060	0.080	0.100	0.100	0.100
	0.020	0.040	0.060	0.080	0.100	0.100	0.100
	0.020	0.040	0.060	0.080	0.100	0.100	0.100
	0.020	0.040	0.060	0.080	0.100	0.100	0.100
	0.020	0.040	0.060	0.080	0.100	0.100	0.100

	Feed f_z (mm/z) with tool diameter						
	z 4	z 4	z 6	z 6	z 6	z 6	z 8
	< 5.000	> 5.000 - 6.200	> 6.200 - 8.000	> 8.000 - 12.000	> 12.000 - 16.000	> 16.000 - 16.200	> 16.200 - 20.200
	0.060	0.100	0.100	0.100	0.100	0.100	0.100
	0.060	0.100	0.100	0.100	0.100	0.100	0.100
	0.060	0.100	0.100	0.100	0.100	0.100	0.100

	Feed f_z (mm/z) with tool diameter						
	z 4	z 4	z 6	z 6	z 6	z 6	z 6
	< 5.000	> 5.000 - 6.200	> 6.200 - 8.000	> 8.000 - 12.000	> 12.000 - 16.000	> 16.000 - 16.200	> 16.200 - 20.200
	0.015	0.025	0.020	0.040	0.050	0.050	0.050
	0.015	0.025	0.020	0.040	0.050	0.050	0.050

The specified cutting values are guide values.

The optimum data for the respective machining task should be determined during the test or machining.

PRODUCT OVERVIEW





















MonoReam 700 series

The multi-bladed reamers in the MonoReam 700 series offer a new, simple, high-performance, standardised reaming system. The reamers of the MonoReam series are available as expandable versions. Depending on the area of application and workpiece material, they are available as left-angled or straight fluted versions for through and blind bores as well as with different leads and cutting materials.

MonoReam Plus

The MonoReam Plus series is specially designed for machining cast iron and steel. The reamers of this series are equipped with an innovative and patented coolant supply. A sleeve ensures optimal coolant supply to the HPC cutting edges.

The range for through and blind bores is ideally suited to machining in the diameter range from 3.850 to 8.200 mm.

MonoReam			
			
<p>MonoReam 700 Straight fluted design for machining through bores produced of non-ferrous metals with uncoated carbide cutting edges (PCD cutting edges on request).</p> <p>Ø range: 7.700-40.200 mm*</p> <p>    </p>	<p>MonoReam 710 Left-hand fluted design for machining through bores using uncoated or coated carbide blades.</p> <p>Ø range: 7.700-40.200 mm*</p> <p>     </p>	<p>MonoReam 705 Straight fluted design for machining blind bores using uncoated or coated carbide blades (PCD cutting edges on request).</p> <p>Ø range: 7.700-40.200 mm*</p> <p>      </p>	
Page 358	Page 356	Page 359	

* The diameter range can vary, depending on the series.



Series 700 system explanation

The MonoReam reamers in the 700 series are used as fixed tools, however this series is optimised for re-grinding. The reamer is expanded in diameter using a one-piece expansion screw. The expansion system is therefore only suitable for compensation prior to re-grinding and not for setting or re-adjusting the diameter. Due to the expansion of the diameter, it is possible to re-grind all functional surfaces, both on the lead, and also on the tool diameter.

MonoReam Plus



MonoReam Plus | MRP510
Solid cermet head

High-performance reamer with solid cermet head, left-hand fluted

Ø range: 3.850 - 8.200 mm







MonoReam Plus | MRP505
Solid cermet head

High-performance reamer with solid cermet head, straight fluted

Ø range: 3.850 - 8.200 mm



Article overview MonoReam | MonoReam Plus (1/2)

Product category	Type of bore	Material suitability											
		P					K					N	
		1-2	3.1	3.2	3.3	4-6	1	2.1	2.2	2.3	K3	1-2	4
Performance		■	■	■			■	■	■	■			
		■	■	■	■	■	■	■	■	■	■		
												■	■
		■	■	■			■	■	■	■			
		■	■	■	■	■	■	■	■	■	■		
												■	■
		■	■	■			■	■					
		■	■	■			■	■					
		■	■	■			■	■					
		■	■	■			■	■					

Ordering example:

MonoReam Plus series

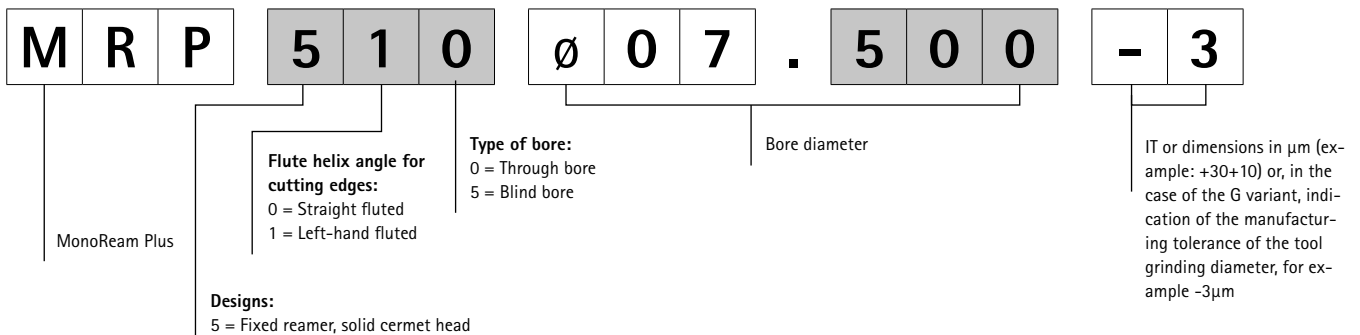

Ordering example:

MonoReam series

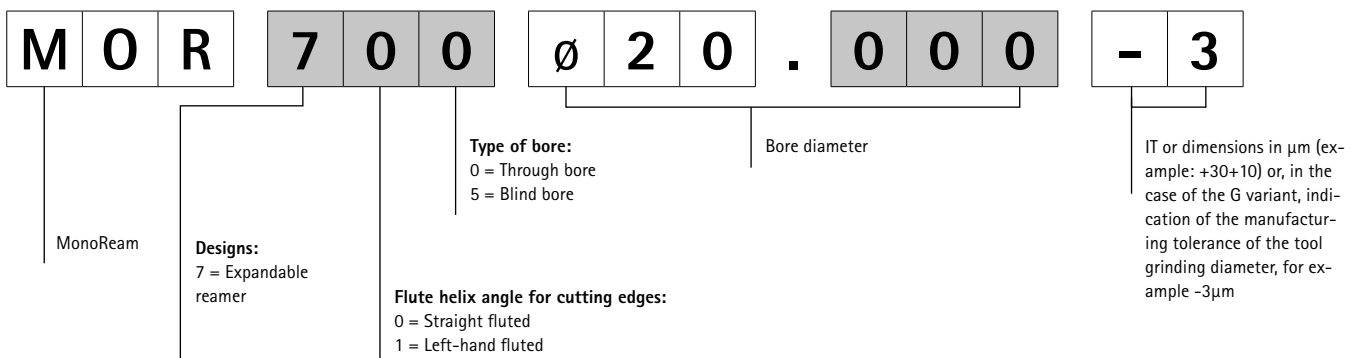

Step 1:
Product category



Step 2:
Type of bore



Step 3:
Material suitability





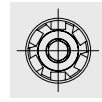



Step 4:
Design



Step 5:
Preconfigured diameters or configuration

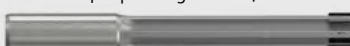

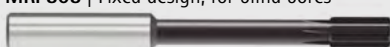
	Design					Preconfigured diameters		Configuration
	d ₁	Cutting material	Lead	 fixed	 expandable	Series	Page	
	7.700 - 40.200	CU130	MY1G		<input checked="" type="checkbox"/>	MOR710	356	MOR710 Expanding version, for through bores 
	7.700 - 40.200	HP421	MY1G		<input checked="" type="checkbox"/>	MOR710	357	
	7.700 - 40.200	HU612	MY1G		<input checked="" type="checkbox"/>	MOR700	358	MOR700 
	7.700 - 40.200	CU130	MU2A		<input checked="" type="checkbox"/>	MOR705	359	MOR705 Expanding version, for blind bores 
	7.700 - 40.200	HP421	MU2A		<input checked="" type="checkbox"/>	MOR705	360	
	7.700 - 40.200	HU612	MU2A		<input checked="" type="checkbox"/>	MOR705	361	
	3.850 - 10.200	CU178	MG1M	<input checked="" type="checkbox"/>		MRP510	362	MRP510 Fixed design, for through bores 
	3.850 - 10.200	CU178	MV3C	<input checked="" type="checkbox"/>		MRP505	363	MRP505 Fixed design, for blind bores 

Lead

Cutting material

M G 1 M - **C U 1 7 8**

Lead geometry and rake angle:
MG1M
MV3C

Cutting material:
CU178

For explanation of the lead geometries, see pages 752.

Lead

Cutting material

M Y 1 G - **C P 1 3 6**

Lead geometry and rake angle:
MY1G
MU2A

Cutting material:
HP421
HU612
CU130
PCD on request

For explanation of the lead geometries, see pages 752.

Article overview MonoReam | MonoReam Plus Configuration (2/2)

MOR710

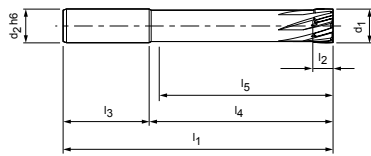

MOR700

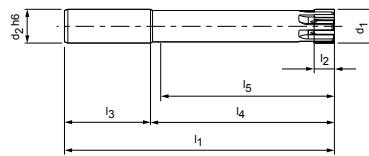

MOR705

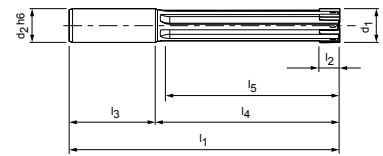

Tool dimensions

MOR710 | MOR700

d_1	d_2	l_1	l_2	l_3	l_4	l_5	z
7,700 - 9,700	12	120	8	45	75	70	4
9,701 - 11,700	12	120	8	45	75	70	6
11,701 - 17,200	16	140	8	48	92	87	6
17,201 - 22,200	20	160	12	50	110	105	6
22,201 - 27,200	20	180	12	50	130	125	6
27,201 - 29,200	25	200	12	56	144	139	6
29,201 - 40,200	25	200	12	56	144	139	8

MOR705

d_1	d_2	l_1	l_2	l_3	l_4	l_5	z
7,700 - 9,700	12	120	8	45	75	64	4
9,701 - 11,700	12	120	8	45	75	65	6
11,701 - 17,200	16	140	8	48	92	80	6
17,201 - 18,200	20	160	12	50	110	98	6
18,201 - 19,200	20	160	12	50	110	99	6
19,201 - 22,200	20	160	12	50	110	100	6
22,201 - 27,200	20	180	12	50	130	120	6
27,201 - 29,200	25	200	12	56	144	130	6
29,201 - 40,200	25	200	12	56	144	130	8



MRP510

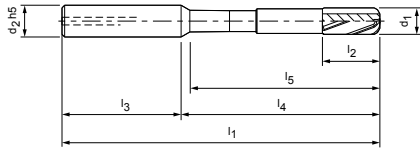

MRP505

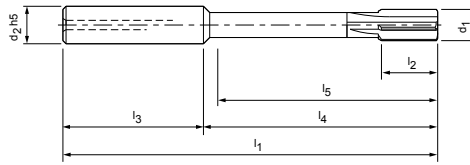
**Tool dimensions**

MRP510

d ₁	d ₂	l ₁	l ₂	l ₃	l ₄	l ₅	z
3,850 - 4,900	10	80	14	40	40	33	4
4,901 - 6,200	12	85	14	45	40	33	4
6,201 - 6,700	12	105	14	45	60	52	6
6,701 - 8,200	12	110	18	45	65	57	6

MRP505

d ₁	d ₂	l ₁	l ₂	l ₃	l ₄	l ₅	z
3,850 - 4,900	10	80	12	40	40	33	4
4,901 - 6,200	12	85	12	45	40	33	4
6,201 - 6,700	12	105	12	45	60	53	6
6,701 - 8,200	12	110	16	45	65	58	6

Tolerances for the G variant/fixed variant MOR7XX | MRP5XX:

Cutting material	Diameter range
	Ø 7.700-40.200
Uncoated	-0,003
CU130	
HU612	
CU178	
Coated (coating thickness 1 - 2 µm)	-0,004
HP421	
CP136	

Explanation of the G-variant MOR | MRP

Permissible workpiece tolerances for selecting the tool diameter

G variant design:

The G variant indicates the tool diameter of the reamer with our manufacturing tolerances. The manufacturing tolerances depend on the cutting material. See permissible smallest tolerances for the G-variant.

MonoReam

Expanding design, for through bores
MOR710

Design:

Reamer diameter:
Lead:
Cutting material:

7.700–40.200 mm
MY1G
CU130
Uncoated cermet

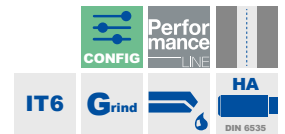
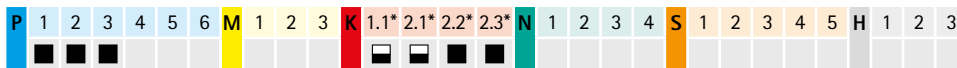
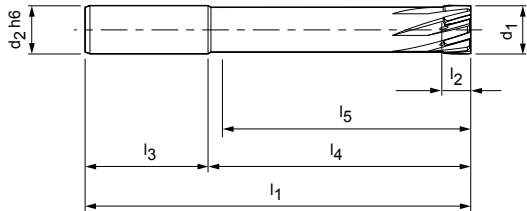

Configurable features



Bore diameter tolerance ≥ IT6:
- Diameter freely selectable in increments of 0.001 mm
- Can be ordered in tolerance ≥ IT6

Specification:
MOR710Ø[diameter][tolerance]MY1G-CU130

G variants:
- Diameter freely selectable in increments of 0.001 mm
- Can be ordered from tolerance ≥ 3 µm (G variant, see page 355)

G variant specification:
MOR710GØ[diameter][tolerance]MY1G-CU130

Dimensions of configurable series IT6

d ₁	d ₂	l ₁	l ₂	l ₃	l ₄	l ₅	z
7,700 - 9,700	12	120	8	45	75	70	4
9,701 - 11,700	12	120	8	45	75	70	6
11,701 - 17,200	16	140	8	48	92	87	6
17,201 - 22,200	20	160	12	50	110	105	6
22,201 - 27,200	20	180	12	50	130	125	6
27,201 - 29,200	25	200	12	56	144	139	6
29,201 - 40,200	25	200	12	56	144	139	8

IT6 tolerance example:
MOR710Ø16.350H6MY1G-CU130

Bore diameter d₁ = 16.350 H6

G variant example:
MOR710GØ16.350-3MY1G-CU130

Special tool diameter d₁ = 16.350 -3 µm

Dimensions in mm.
* for surfaces R_a < 2 µm
For cutting data recommendations, see end of chapter.

MonoReam

Expanding design, for through bores
MOR710

Design:

Reamer diameter:

7.700–40.200 mm

Lead:

MY1G

Cutting material:

HP421

Carbide

PVD-coated

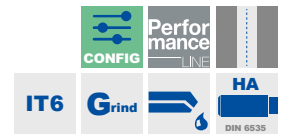
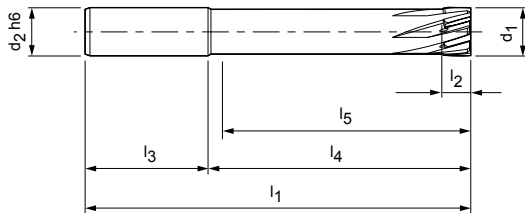

Configurable features

Bore diameter tolerance \geq IT6:

- Diameter freely selectable in increments of 0.001 mm
- Can be ordered in tolerance \geq IT6

Specification:

MOR710Ø[diameter][tolerance]MY1G-HP421

G variants:

- Diameter freely selectable in increments of 0.001 mm
- From tolerance \geq 4 μ m orderable (G variant, see page 355)

G variant specification:

MOR710GØ[diameter][tolerance]MY1G-HP421

Dimensions of configurable series IT6

d_1	d_2	l_1	l_2	l_3	l_4	l_5	z
7,700 - 9,700	12	120	8	45	75	70	4
9,701 - 11,700	12	120	8	45	75	70	6
11,701 - 17,200	16	140	8	48	92	87	6
17,201 - 22,200	20	160	12	50	110	105	6
22,201 - 27,200	20	180	12	50	130	125	6
27,201 - 29,200	25	200	12	56	144	139	6
29,201 - 40,200	25	200	12	56	144	139	8

IT6 tolerance example:

MOR710Ø16.350H6MY1G-HP421

Bore diameter $d_1 = 16.350$ H6

G variant example:

MOR710GØ16.350-4MY1G-HP421

Special tool diameter $d_1 = 16.350 -4 \mu$ m

MonoReam

Expanding design, for through bores
MOR700

Design:

Reamer diameter:
Lead:
Cutting material:

7.700–40.200 mm
MY1G
HU612
Carbide
uncoated

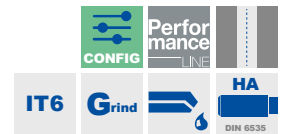
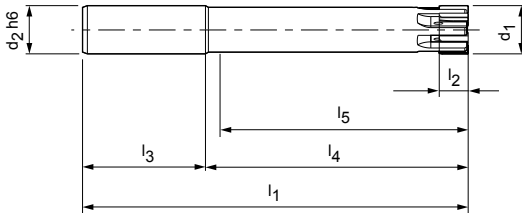

Configurable features



Bore diameter tolerance \geq IT6:
- Diameter freely selectable in increments of 0.001 mm
- Can be ordered in tolerance \geq IT6

Specification:
MOR700Ø[diameter][tolerance]MY1G-HU612

G variants:
- Diameter freely selectable in increments of 0.001 mm
- Can be ordered from tolerance \geq 3 μ m (G variant, see page 355)

G variant specification:
MOR700GØ[diameter][tolerance]MY1G-HU612

Dimensions of configurable series IT6

d ₁	d ₂	l ₁	l ₂	l ₃	l ₄	l ₅	z
7,700 - 9,700	12	120	8	45	75	70	4
9,701 - 11,700	12	120	8	45	75	70	6
11,701 - 17,200	16	140	8	48	92	87	6
17,201 - 22,200	20	160	12	50	110	105	6
22,201 - 27,200	20	180	12	50	130	125	6
27,201 - 29,200	25	200	12	56	144	139	6
29,201 - 40,200	25	200	12	56	144	139	8

IT6 tolerance example:
MOR700Ø16.350H6MY1G-HU612

Bore diameter d₁ = 16.350 H6

G variant example:
MOR700GØ16.350-3MY1G-HU612

Special tool diameter d₁ = 16.350 -3 μ m

MonoReam

Expanding design, straight fluted, for blind bores
MOR705

Design:

Reamer diameter:

7.700–40.200 mm

Lead:

MU2A

Cutting material:

CU130

Uncoated cermet

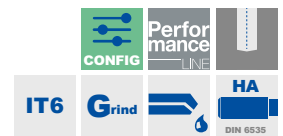
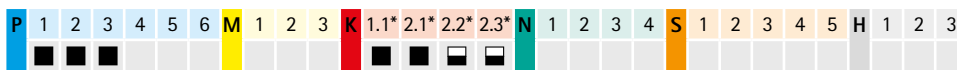
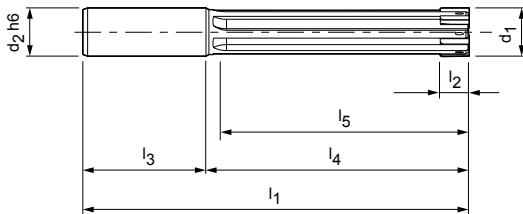

Configurable features

Bore diameter tolerance \geq IT6:

- Diameter freely selectable in increments of 0.001 mm
- Can be ordered in tolerance \geq IT6

Specification:

MOR705Ø[diameter][tolerance]MU2A-CU130

G variants:

- Diameter freely selectable in increments of 0.001 mm
- Can be ordered from tolerance \geq 3 μ m (G variant, see page 355)

G variant specification:

MOR705GØ[diameter][tolerance]MU2A-CU130

Dimensions of configurable series IT6

d_1	d_2	l_1	l_2	l_3	l_4	l_5	z
7,700 - 9,700	12	120	8	45	75	64	4
9,701 - 11,700	12	120	8	45	75	65	6
11,701 - 17,200	16	140	8	48	92	80	6
17,201 - 18,200	20	160	12	50	110	98	6
18,201 - 19,200	20	160	12	50	110	99	6
19,201 - 22,200	20	160	12	50	110	100	6
22,201 - 27,200	20	180	12	50	130	120	6
27,201 - 29,200	25	200	12	56	144	130	6
29,201 - 40,200	25	200	12	56	144	130	8

IT6 tolerance example:

MOR705Ø16.350H6MU2A-CU130

Bore diameter $d_1 = 16.350$ H6

G variant example:

MOR705GØ16.350-3MU2A-CU130

Special tool diameter $d_1 = 16.350 -3 \mu$ m

Dimensions in mm.

* for surfaces $R_a < 2 \mu$ m

For cutting data recommendations, see end of chapter.

MonoReam

Expanding design, straight fluted, for blind bores
MOR705

Design:

Reamer diameter:
Lead:
Cutting material:

7.700–40.200 mm
MU2A
HP421
Carbide
PVD-coated

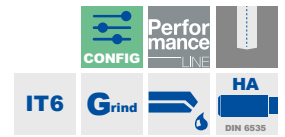
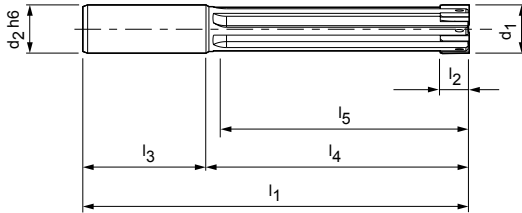

Configurable features



Bore diameter tolerance \geq IT6:
- Diameter freely selectable in increments of 0.001 mm
- Can be ordered in tolerance \geq IT6

Specification:
MOR705Ø[diameter][tolerance]MU2A-HP421

G variants:
- Diameter freely selectable in increments of 0.001 mm
- From tolerance \geq 4 μ m orderable (G variant, see page 355)

G variant specification:
MOR705GØ[diameter][tolerance]MU2A-HP421

Dimensions of configurable series IT6

d ₁	d ₂	l ₁	l ₂	l ₃	l ₄	l ₅	z
7,700 - 9,700	12	120	8	45	75	64	4
9,701 - 11,700	12	120	8	45	75	65	6
11,701 - 17,200	16	140	8	48	92	80	6
17,201 - 18,200	20	160	12	50	110	98	6
18,201 - 19,200	20	160	12	50	110	99	6
19,201 - 22,200	20	160	12	50	110	100	6
22,201 - 27,200	20	180	12	50	130	120	6
27,201 - 29,200	25	200	12	56	144	130	6
29,201 - 40,200	25	200	12	56	144	130	8

IT6 tolerance example:
MOR705Ø16.350H6MU2A-HP421

Bore diameter d₁ = 16.350 H6

G variant example:
MOR705GØ16.350-4MU2A-HP421

Special tool diameter d₁ = 16.350 -4 μ m

MonoReam

Expanding design, straight fluted, for blind bores
MOR705

Design:

Reamer diameter:

7.700–40.200 mm

Lead:

MU2A

Cutting material:

HU612

Carbide

uncoated

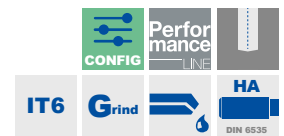
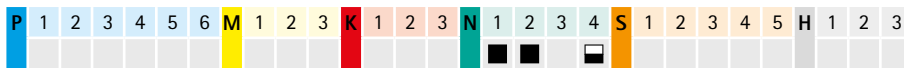
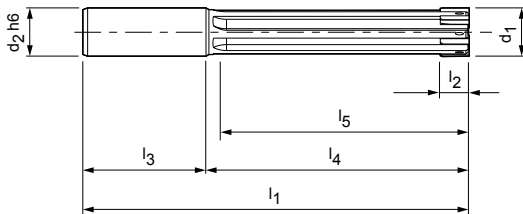

Configurable features

Bore diameter tolerance \geq IT6:

- Diameter freely selectable in increments of 0.001 mm
- Can be ordered in tolerance \geq IT6

Specification:

MOR705Ø[diameter][tolerance]MU2A-HU612

G variants:

- Diameter freely selectable in increments of 0.001 mm
- Can be ordered from tolerance \geq 3 μ m (G variant, see page 355)

G variant specification:

MOR705GØ[diameter][tolerance]MU2A-HU612

Dimensions of configurable series IT6

d_1	d_2	l_1	l_2	l_3	l_4	l_5	z
7,700 - 9,700	12	120	8	45	75	64	4
9,701 - 11,700	12	120	8	45	75	65	6
11,701 - 17,200	16	140	8	48	92	80	6
17,201 - 18,200	20	160	12	50	110	98	6
18,201 - 19,200	20	160	12	50	110	99	6
19,201 - 22,200	20	160	12	50	110	100	6
22,201 - 27,200	20	180	12	50	130	120	6
27,201 - 29,200	25	200	12	56	144	130	6
29,201 - 40,200	25	200	12	56	144	130	8

IT6 tolerance example:

MOR705Ø16.350H6MU2A-HU612

Bore diameter $d_1 = 16.350$ H6

G variant example:

MOR705GØ16.350-3MU2A-HU612

Special tool diameter $d_1 = 16.350 -3 \mu$ m

MonoReam Plus

Fixed design, for through bores
MRP510

Design:

Reamer diameter:
Lead:
Cutting material:

3.850-10.200 mm
MG1M
CU178
Uncoated cermet

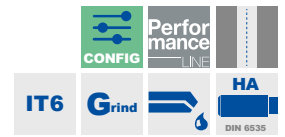
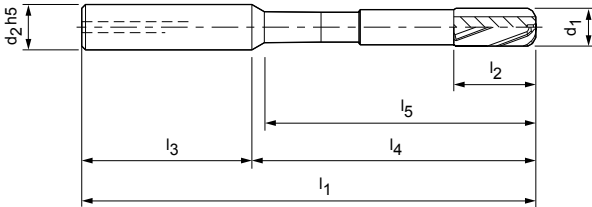

Configurable features



Bore diameter tolerance \geq IT6:
- Diameter freely selectable in increments of 0.001 mm
- Can be ordered in tolerance \geq IT6

Specification:
MRP510Ø[diameter][tolerance]MG1M-CU178

G variants:
- Diameter freely selectable in increments of 0.001 mm
- Can be ordered from tolerance \geq 3 μ m (G variant, see page 355)

G variant specification:
MRP510GØ[diameter][tolerance]MG1M-CU178

Dimensions of configurable series IT6

d ₁	d ₂	l ₁	l ₂	l ₃	l ₄	l ₅	z
3,850 - 4,900	10	80	14	40	40	33	4
4,901 - 6,200	12	85	14	45	40	33	4
6,201 - 6,700	12	105	14	45	60	52	6
6,701 - 8,200	12	110	18	45	65	57	6
8,201-8,700	12	120	18	45	75	67	6
8,701-9,700	12	120	22	45	75	67	6
9,701-10,200	12	120	22	45	75	68	6

IT6 tolerance example:
MRP510Ø5.350H6MG1M-CU178

Bore diameter d₁ = 5.350 mm H6

G variant example:
MRP510GØ5.350-3MG1M-CU178

Special tool diameter d₁ = 5.350 -3 μ m

Dimensions in mm.
* for surfaces R_a < 2 μ m
For cutting data recommendations, see end of chapter.

MonoReam Plus

Fixed design, for through bores
MRP505

Design:
Reamer diameter: 3.850-10.200 mm
Lead: MV3C
Cutting material: CU178
Uncoated cermet

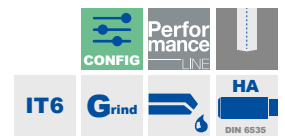
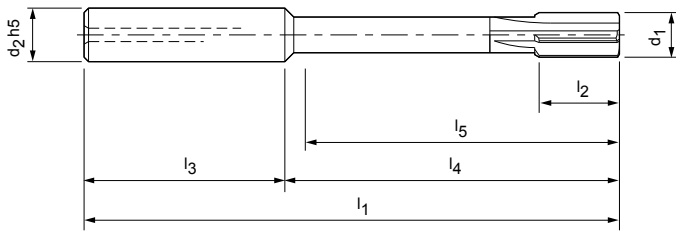

Configurable features



Bore diameter tolerance \geq IT6:
- Diameter freely selectable in increments of 0.001 mm
- Can be ordered in tolerance \geq IT6

Specification:
MRP505Ø[diameter][tolerance]MV3C-CU178

G variants:
- Diameter freely selectable in increments of 0.001 mm
- Can be ordered from tolerance \geq 3 μ m (G variant, see page 355)

G variant specification:
MRP505GØ[diameter][tolerance]MV3C-CU178

Dimensions of configurable series IT6

d_1	d_2	l_1	l_2	l_3	l_4	l_5	z
3,850 - 4,900	10	80	12	40	40	33	4
4,901 - 6,200	12	85	12	45	40	33	4
6,201 - 6,700	12	105	12	45	60	53	6
6,701 - 8,200	12	110	16	45	65	58	6
8,201-10,200	12	120	19	45	75	68	6

IT6 tolerance example:
MRP505Ø5.350H6MV3C-CU178

Bore diameter $d_1 = 5.350$ mm H6

G variant example:
MRP505Ø5.350-3MV3C-CU178

Special tool diameter $d_1 = 5.350$ -3 μ m

Dimensions in mm.

* for surfaces $R_a < 2 \mu$ m

For cutting data recommendations, see end of chapter.

Cutting data recommendations for MonoReam MOR | MonoReam Plus MRP

Feed and cutting speed

MRP505 | MRP510

Cutting material: CU178 | Lead: MV3C | MG1M

MMG*	Workpiece material	Strength/hardness [N/mm ²] [HRC]	Cutting speed v _c (m/min)			
			Internal cooling	External cooling	MQL	
P	P1.1	Structural, free-cutting, case hardened and heat-treated steels, non-alloy	< 700	150	75	125
	P1.2	Structural, free-cutting, case hardened and heat-treated steels, non-alloy	< 1200	150	75	125
	P2.1	Nitrided, case hardened and heat-treated steels, alloy	< 900	130	65	110
	P2.2	Nitrided, case hardened and heat-treated steels, alloy	< 1400	130	65	110
	P3.1	Tool, bearing, spring and high-speed steels**	< 800	130	65	110
	P3.2	Tool, bearing, spring and high-speed steels**	< 1000	120	60	100
	P3.3	Tool, bearing, spring and high-speed steels**	< 1500			

MOR705 | MOR710

Cutting material: CU130 | Lead: MU2A | MY1G

MMG*	Workpiece material	Strength/hardness [N/mm ²] [HRC]	Cutting speed v _c (m/min)			
			Internal cooling	External cooling	MQL	
P	P1.1	Structural, free-cutting, case hardened and heat-treated steels, non-alloy	< 700	150	75	125
	P1.2	Structural, free-cutting, case hardened and heat-treated steels, non-alloy	< 1200	150	75	125
	P2.1	Nitrided, case hardened and heat-treated steels, alloy	< 900	130	65	110
	P2.2	Nitrided, case hardened and heat-treated steels, alloy	< 1400	130	65	110
	P3.1	Tool, bearing, spring and high-speed steels**	< 800	130	65	110
	P3.2	Tool, bearing, spring and high-speed steels**	< 1000	120	60	100
	P3.3	Tool, bearing, spring and high-speed steels**	< 1500			
K	K1.1	Cast iron with lamellar graphite (grey cast iron), GJL	< 300	120	100	100
	K2.1	Cast iron with spheroidal graphite, GJS	< 500	120	85	105
	K2.2	Cast iron with spheroidal graphite, GJS	≤ 800			
	K2.3	Cast iron with spheroidal graphite, GJS	> 800			

MOR705 | MOR710

Cutting material: HP421 | Lead: MU2A | MY1G

MMG*	Workpiece material	Strength/hardness [N/mm ²] [HRC]	Cutting speed v _c (m/min)			
			Internal cooling	External cooling	MQL	
P	P3.1	Tool, bearing, spring and high-speed steels**	< 800			
	P3.2	Tool, bearing, spring and high-speed steels**	< 1000			
	P3.3	Tool, bearing, spring and high-speed steels**	< 1500	100	50	75
	P4.1	Stainless steels, ferritic and martensitic		40	20	30
	P5.1	Cast steel		110	60	80
	P6.1	Stainless cast steel, ferritic and martensitic		40	20	30
K	K1.1	Cast iron with lamellar graphite (grey cast iron), GJL	< 300	120	100	100
	K2.1	Cast iron with spheroidal graphite, GJS	< 500	110	80	95
	K2.2	Cast iron with spheroidal graphite, GJS	≤ 800	90	65	75
	K2.3	Cast iron with spheroidal graphite, GJS	> 800	90	55	70
	K3.1	Cast iron with spheroidal graphite, GJV; malleable cast iron, GJM	< 500	90	55	70
	K3.2	Cast iron with spheroidal graphite, GJV; malleable cast iron, GJM	> 500	90	55	70

* MAPAL machining groups

** If the alloy parts Cr, Mo, Ni, V, W in total > 8% then select the next highest MAPAL machining group.

	Feed f_z (mm/z) with tool diameter		
	z 4	z 4	z 6
	< 5.000	5.000 - 6.200	> 6.200 - 8.200
	0.025	0.040	0.060
	0.025	0.040	0.060
	0.025	0.040	0.060
	0.025	0.040	0.060
	0.025	0.040	0.060
	0.025	0.040	0.060

	Feed f_z (mm/z) with tool diameter			
	z 4	z 6	z 6	z 8
	8.000 - 9.700	> 9.700 - 16.000	> 16.000 - 29.200	> 29.200 - 40.200
	0.100	0.150	0.150	0.150
	0.100	0.150	0.150	0.150
	0.100	0.150	0.150	0.150
	0.080	0.120	0.120	0.120
	0.100	0.150	0.150	0.150
	0.100	0.150	0.150	0.150
	0.150	0.200	0.200	0.250
	0.150	0.180	0.180	0.180

	Feed f_z (mm/z) with tool diameter			
	z 4	z 6	z 6	z 8
	8.000 - 9.700	> 9.700 - 16.000	> 16.000 - 29.200	> 29.200 - 40.200
	0.100	0.150	0.150	0.150
	0.080	0.100	0.120	0.120
	0.150	0.150	0.150	0.150
	0.080	0.100	0.120	0.120
	0.150	0.200	0.200	0.250
	0.150	0.180	0.180	0.180
	0.150	0.180	0.180	0.180
	0.120	0.150	0.150	0.150
	0.150	0.180	0.180	0.180
	0.150	0.150	0.150	0.150

The specified cutting values are guide values.

The optimum data for the respective machining task should be determined during the test or machining.

Cutting data recommendations for MonoReam MOR

Feed and cutting speed

MOR700

Cutting material: HU612 | Lead: MY1G

MMG*	Workpiece material	Strength/hardness [N/mm ²] [HRC]	Cutting speed v _c (m/min)		
			Internal cooling	External cooling	MQL
N1	N1.1 Aluminium, non-alloy and alloy < 3 % Si		50	25	40
	N1.2 Aluminium, alloy ≤ 7 % Si		50	25	40
	N1.3 Aluminium, alloy > 7-12 % Si		30	15	25
	N1.4 Aluminium, alloy > 12 % Si		30	15	25
N2	N2.1 Copper, unalloyed and low-alloyed	< 300	50	25	
	N2.2 Copper, alloy	> 300	50	25	
	N2.3 Brass, bronze, gunmetal	< 1200	50	25	40
N4	N4.1 Plastic, thermoplastics		40	20	
	N4.2 Plastic, thermosets		40	20	
	N4.3 Plastic, foams		40	20	

MOR705

Cutting material: HU612 | Lead: MU2A

MMG*	Workpiece material	Strength/hardness [N/mm ²] [HRC]	Cutting speed v _c (m/min)		
			Internal cooling	External cooling	MQL
N1	N1.1 Aluminium, non-alloy and alloy < 3 % Si		50	25	40
	N1.2 Aluminium, alloy ≤ 7 % Si		50	25	40
	N1.3 Aluminium, alloy > 7-12 % Si		30	15	25
	N1.4 Aluminium, alloy > 12 % Si		30	15	25
N2	N2.1 Copper, unalloyed and low-alloyed	< 300	50	25	
	N2.2 Copper, alloy	> 300	50	25	
	N2.3 Brass, bronze, gunmetal	< 1200	50	25	40

	Feed f_z (mm/z) with tool diameter			
	z 4	z 6	z 6	z 8
	8.000 - 9.700	> 9.700 - 16.000	> 16.000 - 29.200	> 29.200 - 40.200
	0.050	0.080	0.100	0.120
	0.050	0.080	0.100	0.120
	0.050	0.080	0.100	0.120
	0.050	0.080	0.100	0.120
	0.050	0.080	0.100	0.120
	0.050	0.080	0.100	0.120
	0.050	0.080	0.100	0.120
	0.050	0.080	0.080	0.080
	0.050	0.080	0.080	0.080
	0.050	0.080	0.080	0.080

	Feed f_z (mm/z) with tool diameter			
	z 4	z 6	z 6	z 8
	8.000 - 9.700	> 9.700 - 16.000	> 16.000 - 29.200	> 29.200 - 40.200
	0.050	0.080	0.100	0.120
	0.050	0.080	0.100	0.120
	0.050	0.080	0.100	0.120
	0.050	0.080	0.100	0.120
	0.050	0.080	0.100	0.120
	0.050	0.080	0.100	0.120
	0.050	0.080	0.100	0.120

The specified cutting values are guide values.

The optimum data for the respective machining task should be determined during the test or machining.

PRODUCT OVERVIEW

HPR replaceable head reamer

The HPR range of replaceable head reamers includes series for through and blind bores from a diameter of 7.00 mm. The replaceable head reamers are available either as a fixed design (XX series) or as a finely adjustable design (XX series) and can be fitted with various cutting materials such as carbide or cermet. The reamers can be configured in the diameter range from 7.00 to 65.00 mm in increments of one μm and in the tolerance range $\geq \text{IT5}$. A wide range of H7 dimensions is available as a preferred series.

With the Head Fitting System (HFS), the associated tool holders are characterised by exact radial run-out and changeover accuracy of less than 3 μm and safe, simple handling, especially when mounting and dismounting the tool head. HFS guarantees high precision and power transmission. The simple design with direct coolant supply to the cutting edge makes the system limited suitable for minimum quantity lubrication (MQL).

HPR fixed design



HPR series 100 | 130 | 131 | 110 | 150 | 180

Fixed design with brazed cutting edges.

\varnothing range: 7.000-65.000 mm*

Perfor
mance
LINE



P M K N S



HPR finely adjustable design



HPR series 200 | 230 | 231 | 210 | 250 | 280

Adjustable to the μm by means of an adjustment system.

\varnothing range: 7.000-65.000 mm*

Expert
LINE



P M K N S

Step 1:
Type of bore



Step 2:
Material suitability



Step 3:
Design



Step 4:
Product category



Step 5:
Preconfigured diameters or configuration



	Design			Preconfigured diameters				Configuration
	d1	Cutting material	Lead	Performance LINE	fixed series	Expert LINE	Fine adjustable series	
				Series	Page	Series	Page	
	7.000 - 18.590	CU134	ME1G	HPR131	379	HPR231	418	HPR131 HPR231
	15.600 - 65.000	CU134	ME1G	HPR110	390	HPR210*	426	
	7.000 - 18.590	HP421	ME1G	HPR131	380	HPR231	419	
	15.600 - 65.000	HP421	ME1G	HPR110	392	HPR210*	427	
	7.000 - 18.590	HP421	MF1G	HPR131	381	HPR231	420	
	15.600 - 65.000	HP421	MF1G	HPR110	394	HPR210*	428	
	7.000 - 18.590	CP134	MC1G	HPR130	374	HPR230	414	
	15.600 - 65.000	CP134	MC1G	HPR100	383	HPR200*	422	
	7.000 - 18.590	HC419	MC1G	HPR130	375			
	15.600 - 65.000	HC419	MC1G	HPR100	384			
	7.000 - 18.590	HP422	MC1G	HPR130	376	HPR230	415	
	15.600 - 65.000	HP422	MC1G	HPR100	386	HPR200*	423	
	7.000 - 18.590	HP423	MC1G	HPR130	377	HPR230	416	
	15.600 - 65.000	HP423	MC1G	HPR100	388	HPR200*	424	
	7.000 - 18.590	PU620	MA0A	HPR130	378	HPR230	417	
	15.600 - 65.000	PU620	MA0A	HPR100	389	HPR200*	425	
	7.000 - 18.590	HP625	MF1G	HPR131	382	HPR231	421	
	15.600 - 65.000	HP625	MF1G	HPR110	393	HPR210*	431	
	7.000 - 21.290	CU134	ML2G	HPR180	396	HPR280	430	
	16.600 - 65.000	CU134	ML2G	HPR150	405	HPR250	438	
	7.000 - 21.290	HP421	ML2G	HPR180	397	HPR280	431	
	16.600 - 65.000	HP421	ML2G	HPR150	406	HPR250	439	
	7.000 - 21.290	HP421	MO2G	HPR180	398	HPR280	432	
	16.600 - 65.000	HP421	MO2G	HPR150	407	HPR250	440	
	7.000 - 21.290	CP134	MC1G	HPR180	399	HPR280	433	
	16.600 - 65.000	CP134	MC1G	HPR150	408	HPR250	441	
	7.000 - 21.290	HC419	MC1G	HPR180	400			
	16.600 - 65.000	HC419	MC1G	HPR150	403			
	7.000 - 21.290	HP421	MC1G	HPR180	401	HPR280	434	
	16.600 - 65.000	HP421	MC1G	HPR150	410	HPR250	442	
	7.000 - 21.290	HP423	MC1G	HPR180	402	HPR280	435	
	16.600 - 65.000	HP423	MC1G	HPR150	411	HPR250	443	
	7.000 - 21.290	PU620	MA0A	HPR180	403	HPR280	436	
	16.600 - 65.000	PU620	MA0A	HPR150	412	HPR250	444	
	7.000 - 21.290	HP625	MO2G	HPR180	404	HPR280	437	
	16.600 - 65.000	HP625	MO2G	HPR150	413	HPR250	445	

Series configuration on next page.

* HPR200/HPR210 Configurable only from diameter 18,600 mm

Article overview HPR | Configuration (2/2)

HPR131 | HPR231

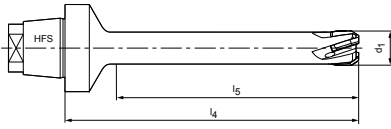

HPR130 | HPR230

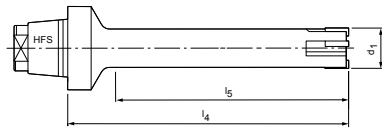

HPR180 | HPR280

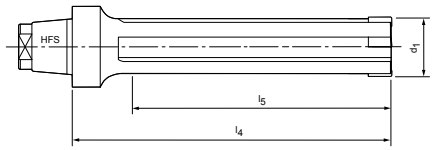

Tool dimensions

	ød ₁	l ₄	l ₅	HFS size	z
HPR130 131 HPR230 231	7,000 - 9,590	60	45	12	4
	9,600 - 18,590	60	45	12	6
HPR180 HPR280	7,000 - 14,590	60	40	12	4
	14,600 - 21,290	60	40	12	6
HPR100 HPR110	15,600 - 18,590	14	-	10	6
	18,600 - 21,290	14,5	-	12	6
	21,300 - 23,990	15,5	-	14	6
	24,000 - 29,990	16	-	16	6
	30,000 - 39,990	17	-	20	8
	40,000 - 50,700	19	-	24	8
HPR150	50,710 - 65,000	25	-	24	8
	16,600 - 21,290	14	-	10	6
	21,300 - 24,990	15,5	-	12	6
	25,000 - 28,990	15,5	-	14	6
	29,000 - 36,990	17	-	16	6
	37,000 - 44,990	17	-	20	8
HPR200 HPR210	45,000 - 50,700	19	-	24	8
	50,710 - 65,000	25	-	24	8
	16,600 - 21,290	25	-	10	6
	21,300 - 24,990	27	-	12	6
HPR250	25,000 - 28,590	35	-	14	6
	29,000 - 32,290	35	-	16	6
	32,300 - 36,990	41	-	16	6
	37,000 - 41,190	41	-	20	8
	41,200 - 44,900	47	-	20	8
	45,000 - 65,000	47	-	24	8
	18,600 - 20,390	25	-	12	6
	20,400 - 21,290	27	-	12	6

	ød ₁	l ₄	l ₅	HFS size	z
HPR200 HPR210	18,600 - 20,390	25	-	12	6
	20,400 - 21,290	27	-	12	6
	21,300 - 23,990	27	-	14	6
	24,000 - 29,990	35	-	16	6
	30,000 - 39,990	41	-	20	8
HPR250	40,000 - 65,000	47	-	24	8
	16,600 - 21,290	25	-	10	6
	21,300 - 24,990	27	-	12	6
	25,000 - 28,590	35	-	14	6
	29,000 - 32,290	35	-	16	6
	32,300 - 36,990	41	-	16	6
	37,000 - 41,190	41	-	20	8
	41,200 - 44,900	47	-	20	8

Ordering example:

Series

H P R

HPR replaceable head reamer

1 0 0

Designs:
1 = Fixed reamer
2 = Finely adjustable reamer

Diameter

G

Flute helix angle for cutting edges:
0 = Straight fluted up to ø 65.000 mm
1 = Left-hand fluted up to ø 65.000 mm
3 = Left-hand up to ø 18.590 mm
5 = Blind bore up to ø 65.000 mm
8 = Blind bore up to ø 21.290 mm

ø 2 0 . 0 0 0

G = Tool diameter information
Digit is only used for C and G variants

Bore or tool diameter

Tolerance

- 5

IT or dimensions in µm (example: +30+10) or, in the case of the G variant, indication of the manufacturing tolerance of the tool grinding diameter, for example -3µm

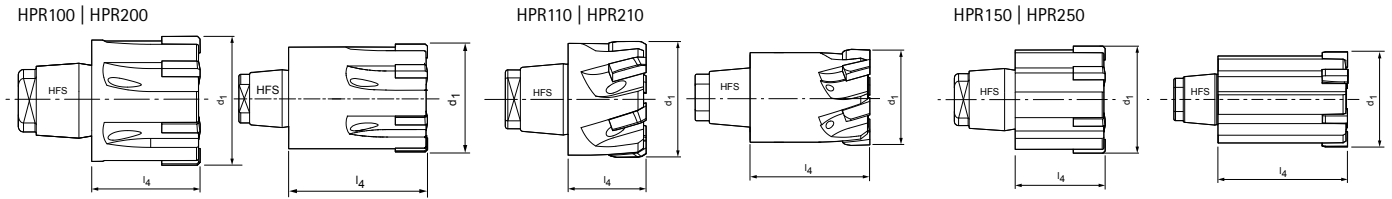

Permissible workpiece tolerances for selecting the tool diameter:

Fixed design:

IT6 (16 µm) over ≥ Ø30.000 HPR

If the tolerance of the workpiece diameter to be machined is smaller than the tolerance class mentioned above, a finely adjustable design or a fixed design as a G variant (special tool diameter) can be selected.

Finely adjustable design:

IT5 (11 µm) over ≥ Ø30.000 HPR

If the tolerance of the workpiece diameter to be machined is smaller than the tolerance class mentioned above, a finely adjustable design as a G variant (special tool diameter) can be selected.

G variant

The G variant then indicates the tool diameter of the reamer with our manufacturing tolerances.

Tolerances for the G variant/fixed variant HPR1XX:

Cutting material	Diameter range	
	Ø 7 - < Ø 60	≥ Ø 60 - Ø 65
Uncoated		
HU612		
CU134	-0.003	-0.006
CU130		
PU620		
Coated (layer thickness 1-2 µm)		
HP421		
CP134	-0.005	-0.008
HP625		
Coated (layer thickness 2-4 µm)		
HP423		
HP463	-0.007	-0.010
CP132		
CP233		
Coated (layer thickness 3-5 µm)		
HC412		
HC413	-0.007	-0.010
HC419		

Tolerances for the G variant/finely adjustable design HPR2XX:
General setting dimension +/-0.001

Lead

Cutting material

M	C	1	G	-	H	P	4	2	1
<p>Lead geometry and rake angle: MC1G ME1G For explanation of MA0A ML2G the lead geometries, MO2G MF1G see pages 752.</p>				<p>Cutting material: HP421 CU134 HP422 HP625 HP423 HC419 CP134 PU620</p>					

HPR replaceable head reamer

Fixed design, straight fluted, for through bores
HPR130

Design:

Reamer diameter:
Lead:
Cutting material:

7.000-18.590 mm
MC1G
CP134
Cermet
PVD-coated

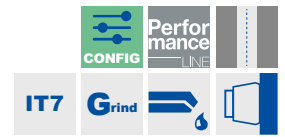
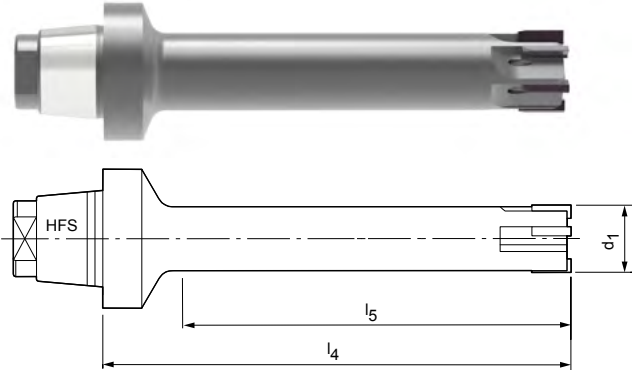

Configurable features



Bore diameter tolerance IT7:
- Diameter freely selectable in increments of 0.001 mm
- Can be ordered in tolerance IT7

Specification:
HPR130Ø[diameter][tolerance]MC1G-CP134

Bore diameter tolerance < IT7:
- Tolerances smaller than IT7 can be ordered as a special tool diameter (G variant, see page 373)

G variant specification:
HPR130GØ[diameter][tolerance]MC1G-CP134

Dimensions of configurable series IT7

d ₁	l ₄	l ₅	HFS size	z
7,000 - 9,590	60	45	12	4
9,600 - 18,590	60	45	12	6

IT7 tolerance example:
HPR130Ø16.350H7MC1G-CP134

Bore diameter d₁ = 16.350 H7

G variant example:
HPR130GØ16.350-5MC1G-CP134

Special tool diameter d₁ = 16.350 -5 µm

Dimensions in mm.

* for surfaces R_a < 2 µm

For associated HFS replaceable head holders, see page 460.

For cutting data recommendations, see end of chapter.

HPR replaceable head reamer

Fixed design, straight fluted, for through bores
HPR130

Design:

Reamer diameter: 7.000–18.590 mm
Lead: MC1G
Cutting material: HC419
Solid carbide
CVD-coated

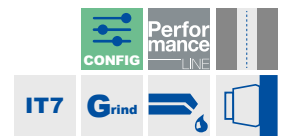
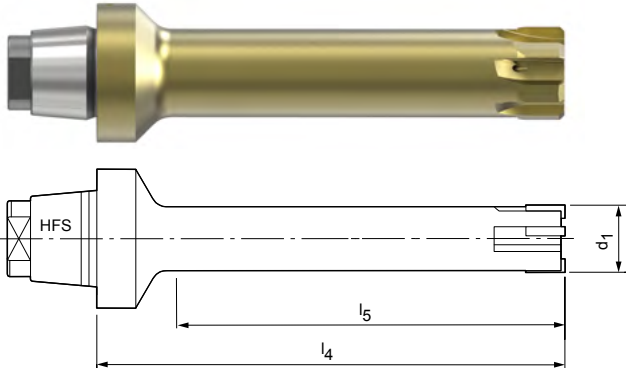

Configurable features



Bore diameter tolerance IT7:

- Diameter freely selectable in increments of 0.001 mm
- Can be ordered in tolerance IT7

Specification:

HPR130Ø[diameter][tolerance]MC1G-HC419

Bore diameter tolerance < IT7:

- Tolerances smaller than IT7 can be ordered as a special tool diameter (G variant, see page 373)

G variant specification:

HPR130GØ[diameter][tolerance]MC1G-HC419

Dimensions of configurable series IT7

d ₁	l ₄	l ₅	HFS size	z
7,000 - 9,590	60	45	12	4
9,600 - 18,590	60	45	12	6

IT7 tolerance example:

HPR130Ø16.350H7MC1G-HC419

Bore diameter d₁ = 16.350 H7

G variant example:

HPR130GØ16.350-7MC1G-HC419

Special tool diameter d₁ = 16.350 -7 μm

Dimensions in mm.

* for surfaces R_a < 2 μm

For associated HFS replaceable head holders, see page 460.

For cutting data recommendations, see end of chapter.

HPR replaceable head reamer

Fixed design, straight fluted, for through bores
HPR130

Design:

Reamer diameter:
Lead:
Cutting material:

7.000-18.590 mm
MC1G
HP421
Carbide
PVD-coated

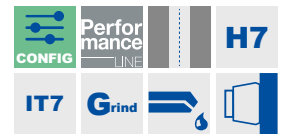
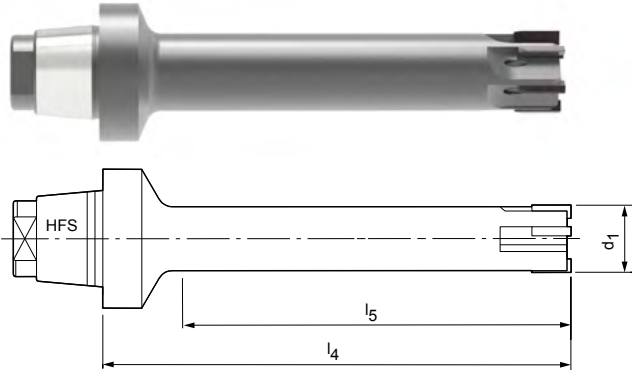

Preferred series in H7

d ₁ H7	HFS size	Dimensions			Specification	Order no.
		l ₄	l ₅	z		
10,000	12	60	45	6	HPR130Ø10H7MC1G-HP421	30058428
12,000	12	60	45	6	HPR130Ø12H7MC1G-HP421	30201261
14,000	12	60	45	6	HPR130Ø14H7MC1G-HP421	30710146
16,000	12	60	45	6	HPR130Ø16H7MC1G-HP421	30710148
18,000	12	60	45	6	HPR130Ø18H7MC1G-HP421	30156684

Configurable features



Bore diameter tolerance IT7:
- Diameter freely selectable in increments of 0.001 mm
- Can be ordered in tolerance IT7

Specification:
HPR130Ø[diameter][tolerance]MC1G-HP421

Bore diameter tolerance < IT7:
- Tolerances smaller than IT7 can be ordered as a special tool diameter (G variant, see page 373)

G variant specification:
HPR130GØ[diameter][tolerance]MC1G-HP421

Dimensions of configurable series IT7

d ₁	l ₄	l ₅	HFS size	z
7,000 - 9,590	60	45	12	4
9,600 - 18,590	60	45	12	6

IT7 tolerance example:
HPR130Ø16.350H7MC1G-HP421

Bore diameter d₁ = 16.350 H7

G variant example:
HPR130GØ16.350-5MC1G-HP421

Special tool diameter d₁ = 16.350 -5 µm

Dimensions in mm.
For associated HFS replaceable head holders, see page 460.
For cutting data recommendations, see end of chapter.

HPR replaceable head reamer

Fixed design, straight fluted, for through bores
HPR130

Design:

Reamer diameter: 7.000–18.590 mm
Lead: MC1G
Cutting material: HP423
Carbide
PVD-coated

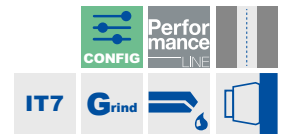
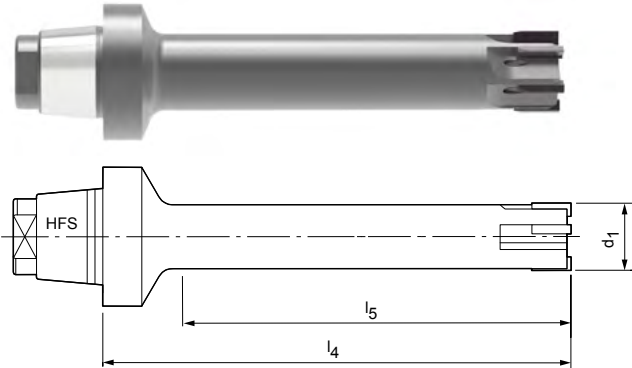

Configurable features



Bore diameter tolerance IT7:

- Diameter freely selectable in increments of 0.001 mm
- Can be ordered in tolerance IT7

Specification:

HPR130Ø[diameter][tolerance]MC1G-HP423

Bore diameter tolerance < IT7:

- Tolerances smaller than IT7 can be ordered as a special tool diameter (G variant, see page 373)

G variant specification:

HPR130GØ[diameter][tolerance]MC1G-HP423

Dimensions of configurable series IT7

d_1	l_4	l_5	HFS size	z
7,000 - 9,590	60	45	12	4
9,600 - 18,590	60	45	12	6

IT7 tolerance example:

HPR130Ø16.350H7MC1G-HP423

Bore diameter $d_1 = 16.350 \text{ H7}$

G variant example:

HPR130GØ16.350-8MC1G-HP423

Special tool diameter $d_1 = 16.350 -7 \mu\text{m}$

Dimensions in mm.

For associated HFS replaceable head holders, see page 460.

For cutting data recommendations, see end of chapter.

HPR replaceable head reamer

Fixed design, straight fluted, for through bores
HPR130

Design:

Reamer diameter:
Lead:
Cutting material:

7.000-18.590 mm
MA0A
PU620
PCD-tipped

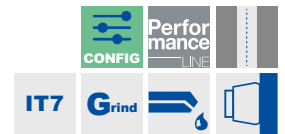
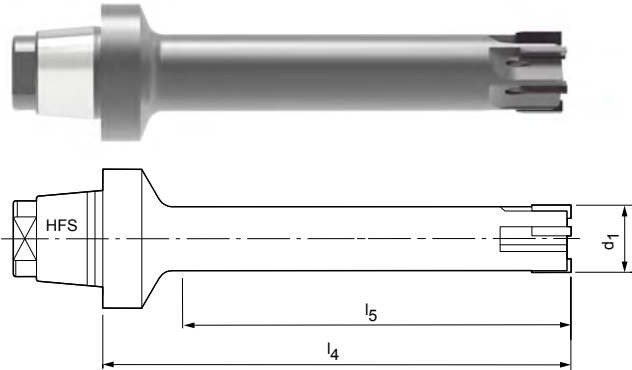

Configurable features



Bore diameter tolerance IT7:
- Diameter freely selectable in increments of 0.001 mm
- Can be ordered in tolerance IT7

Specification:
HPR130Ø[diameter][tolerance]MA0A-PU620

Bore diameter tolerance < IT7:
- Tolerances smaller than IT7 can be ordered as a special tool diameter (G variant, see page 373)

G variant specification:
HPR130GØ[diameter][tolerance]MA0A-PU620

Dimensions of configurable series IT7

d ₁	l ₄	l ₅	HFS size	z
7,000 - 9,590	60	45	12	4
9,600 - 18,590	60	45	12	6

IT7 tolerance example:
HPR130Ø16.350H7MA0A-PU620

Bore diameter d₁ = 16.350 H7

G variant example:
HPR130GØ16.350-3MA0A-PU620

Special tool diameter d₁ = 16.350 -3 µm

Dimensions in mm.
For associated HFS replaceable head holders, see page 460.
For cutting data recommendations, see end of chapter.

HPR replaceable head reamer

Fixed design, left-hand grooved, for through bores
HPR131

Design:

Reamer diameter:

7.000–18.590 mm

Lead:

ME1G

Cutting material:

CU134

Uncoated cermet

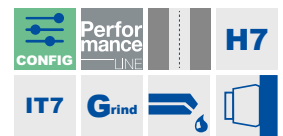
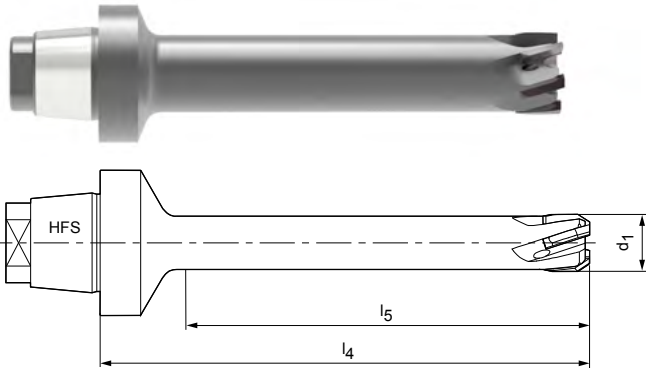

Preferred series in H7

d ₁ H7	HFS size	Dimensions			Specification	Order no.
		l ₄	l ₅	z		
10,000	12	60	45	6	HPR131Ø10H7ME1G-CU134	30043741
11,000	12	60	45	6	HPR131Ø11H7ME1G-CU134	30087260
12,000	12	60	45	6	HPR131Ø12H7ME1G-CU134	30041656
13,000	12	60	45	6	HPR131Ø13H7ME1G-CU134	30057835
14,000	12	60	45	6	HPR131Ø14H7ME1G-CU134	30082580
16,000	12	60	45	6	HPR131Ø16H7ME1G-CU134	30047996
18,000	12	60	45	6	HPR131Ø18H7ME1G-CU134	30048997

Configurable features

Bore diameter tolerance IT7:

- Diameter freely selectable in increments of 0.001 mm
- Can be ordered in tolerance IT7

Specification:

HPR131Ø[diameter][tolerance]ME1G-CU134

Bore diameter tolerance < IT7:

- Tolerances smaller than IT7 can be ordered as a special tool diameter (G variant, see page 373)

G variant specification:

HPR131GØ[diameter][tolerance]ME1G-CU134

Dimensions of configurable series IT7

d ₁	l ₄	l ₅	HFS size	z
7,000 - 9,590	60	45	12	4
9,600 - 18,590	60	45	12	6

IT7 tolerance example:

HPR131Ø16.350H7ME1G-CU134

Bore diameter d₁ = 16.350 H7

G variant example:

HPR131GØ16.350-3ME1G-CU134

Special tool diameter d₁ = 16.350 -3 µm

Dimensions in mm.

For associated HFS replaceable head holders, see page 460.

For cutting data recommendations, see end of chapter.

HPR replaceable head reamer

Fixed design, left-hand grooved, for through bores
HPR131

Design:

Reamer diameter:
Lead:
Cutting material:

7.000-18.590 mm
ME1G
HP421
Carbide
PVD-coated

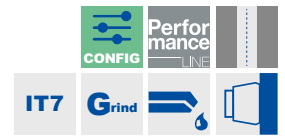
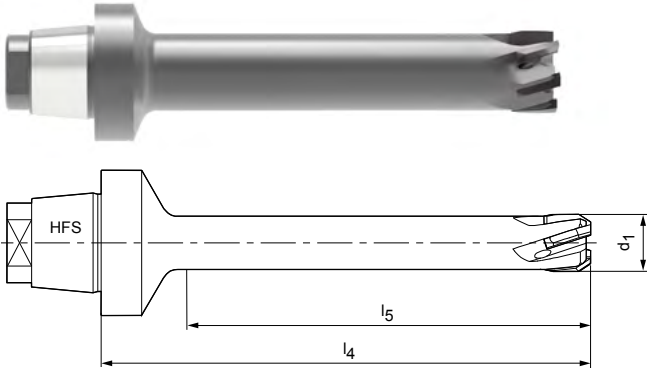

Configurable features



Bore diameter tolerance IT7:
- Diameter freely selectable in increments of 0.001 mm
- Can be ordered in tolerance IT7

Specification:
HPR131Ø[diameter][tolerance]ME1G-HP421

Bore diameter tolerance < IT7:
- Tolerances smaller than IT7 can be ordered as a special tool diameter (G variant, see page 373)

G variant specification:
HPR131GØ[diameter][tolerance]ME1G-HP421

Dimensions of configurable series IT7

d ₁	l ₄	l ₅	HFS size	z
7,000 - 9,590	60	45	12	4
9,600 - 18,590	60	45	12	6

IT7 tolerance example:
HPR131Ø16.350H7ME1G-HP421

Bore diameter d₁ = 16.350 H7

G variant example:
HPR131GØ16.350-5ME1G-HP421

Special tool diameter d₁ = 16.350 -5 µm

Dimensions in mm.
For associated HFS replaceable head holders, see page 460.
For cutting data recommendations, see end of chapter.

HPR replaceable head reamer

Fixed design, left-hand grooved, for through bores
HPR131

Design:

Reamer diameter:

7.000–18.590 mm

Lead:

MF1G

Cutting material:

HP421

Carbide

PVD-coated

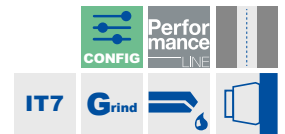
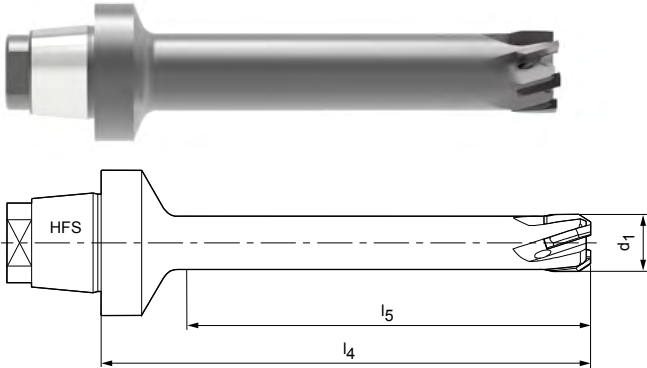
Preferred series in stock in H7

d ₁ H7	HFS size	Dimensions			Specification	Order no.
		l ₄	l ₅	z		
10,000	12	60	45	6	HPR131Ø10.0H7MF1G-HP421	30710160
11,000	12	60	45	6	HPR131Ø11.00H7MF1G-HP421	30710161
12,000	12	60	45	6	HPR131Ø12.00H7MF1G-HP421	30710162
13,000	12	60	45	6	HPR131Ø13.00H7MF1G-HP421	30710163
14,000	12	60	45	6	HPR131Ø14.00H7MF1G-HP421	30710164
16,000	12	60	45	6	HPR131Ø16.00H7MF1G-HP421	30710166
18,000	12	60	45	6	HPR131Ø18.00H7MF1G-HP421	30710168

Configurable features

Bore diameter tolerance IT7:

- Diameter freely selectable in increments of 0.001 mm
- Can be ordered in tolerance IT7

Specification:

HPR131Ø[diameter][tolerance]MF1G-HP421

Bore diameter tolerance < IT7:

- Tolerances smaller than IT7 can be ordered as a special tool diameter (G variant, see page 373)

G variant specification:

HPR131GØ[diameter][tolerance]MF1G-HP421

Dimensions of configurable series IT7

d ₁	l ₄	l ₅	HFS size	z
7,000 - 9,590	60	45	12	4
9,600 - 18,590	60	45	12	6

IT7 tolerance example:

HPR131Ø16.350H7MF1G-HP421

Bore diameter d₁ = 16.350 H7

G variant example:

HPR131GØ16.350-5MF1G-HP421

Special tool diameter d₁ = 16.350 -5 μm

Dimensions in mm.

For associated HFS replaceable head holders, see page 460.

For cutting data recommendations, see end of chapter.

HPR replaceable head reamer

Fixed design, left-hand grooved, for through bores
HPR131

Design:

Reamer diameter:
Lead:
Cutting material:

7.000-18.590 mm
MF1G
HP625
Carbide
PVD-coated

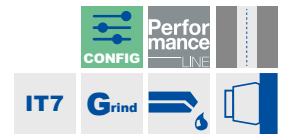
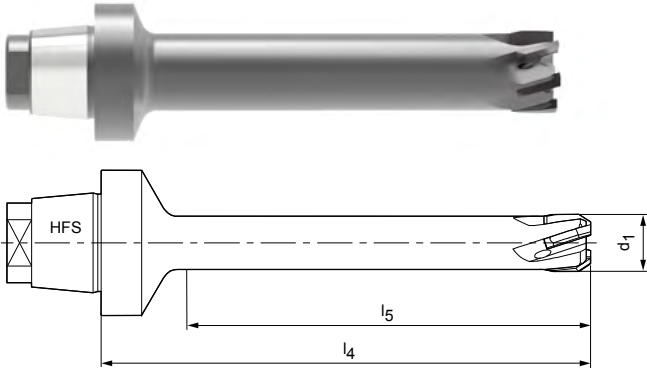

Configurable features



Bore diameter tolerance IT7:
- Diameter freely selectable in increments of 0.001 mm
- Can be ordered in tolerance IT7

Specification:
HPR131Ø[diameter][tolerance]MF1G-HP625

Bore diameter tolerance < IT7:
- Tolerances smaller than IT7 can be ordered as a special tool diameter (G variant, see page 373)

G variant specification:
HPR131GØ[diameter][tolerance]MF1G-HP625

Dimensions of configurable series IT7

d ₁	l ₄	l ₅	HFS size	z
7,000 - 9,590	60	45	12	4
9,600 - 18,590	60	45	12	6

IT7 tolerance example:
HPR131Ø16.350H7MF1G-HP625

Bore diameter d₁ = 16.350 H7

G variant example:
HPR131GØ16.350-7MF1G-HP625

Special tool diameter d₁ = 16.350 -5 µm

Dimensions in mm.
For associated HFS replaceable head holders, see page 460.
For cutting data recommendations, see end of chapter.

HPR replaceable head reamer

Fixed design, straight fluted, for through bores
HPR100

Design:

Reamer diameter: 15.600-65.000 mm
Lead: MC1G
Cutting material: CP134
Cermet
PVD-coated

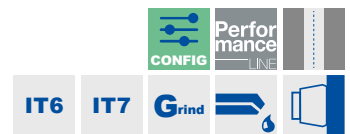
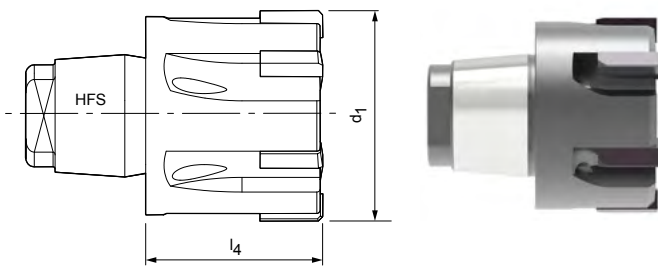

Configurable features

Bore diameter tolerance IT6/IT7:

- Diameter freely selectable in increments of 0.001 mm
- Can be ordered from tolerance IT6/IT7 depending on the diameter range
- > $\varnothing 30.000$ IT6 | $\leq \varnothing 30.000$ IT7

Specification:

HPR100 \varnothing [diameter][tolerance]MC1G-CP134

Bore diameter tolerance < IT6/IT7:

- Tolerances smaller than IT6/IT7 can be ordered as a special tool diameter (G variant, see page 373)

G variant specification:

HPR100G \varnothing [diameter][tolerance]MC1G-CP134

Dimensions of configurable series IT6/IT7

d1	l ₄	l ₅	HFS size	z	Tolerance
15,600 - 18,590	14	-	10	6	IT7
18,600 - 21,290	14,5	-	12	6	IT7
21,300 - 23,990	15,5	-	14	6	IT7
24,000 - 29,990	16	-	16	6	IT7
30,000 - 39,990	17	-	20	8	IT6
40,000 - 50,700	19	-	24	8	IT6
50,710 - 65,000	25	-	24	8	IT6

IT7 tolerance example:

HPR100 \varnothing 16.350H7MC1G-CP134

Bore diameter $d_1 = 16.350$ H7

G variant example:

HPR100G \varnothing 16.350-5MC1G-CP134

Special tool diameter $d_1 = 16.350 -5 \mu\text{m}$

Dimensions in mm.

* for surfaces $R_a < 2 \mu\text{m}$

For associated HFS replaceable head holders, see page 460.

For cutting data recommendations, see end of chapter.

HPR replaceable head reamer

Fixed design, straight fluted, for through bores
HPR100

Design:

Reamer diameter: 15.600-65.000 mm
Lead: MC1G
Cutting material: HC419
Solid carbide
CVD-coated

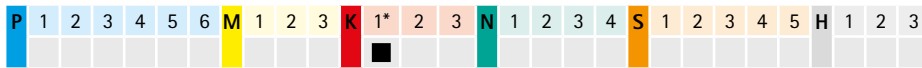
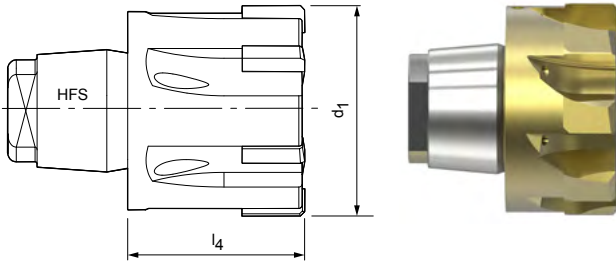

Configurable features



Bore diameter tolerance IT6/IT7:

- Diameter freely selectable in increments of 0.001 mm
- Can be ordered from tolerance IT6/IT7 depending on the diameter range
- > Ø30.000 IT6 | ≤ Ø30.000 IT7

Specification:

HPR100Ø[diameter][tolerance]MC1G-HC419

Bore diameter tolerance < IT6/IT7:

- Tolerances smaller than IT6/IT7 can be ordered as a special tool diameter (G variant, see page 373)

G variant specification:

HPR100GØ[diameter][tolerance]MC1G-HC419

Dimensions of configurable series IT6/IT7

d1	l4	l5	HFS size	z	Tolerance
15,600 - 18,590	14	-	10	6	IT7
18,600 - 21,290	14,5	-	12	6	IT7
21,300 - 23,990	15,5	-	14	6	IT7
24,000 - 29,990	16	-	16	6	IT7
30,000 - 39,990	17	-	20	8	IT6
40,000 - 50,700	19	-	24	8	IT6
50,710 - 65,000	25	-	24	8	IT6

IT7 tolerance example:

HPR100Ø16.350H7MC1G-HC419

Bore diameter d₁ = 16.350 H7

G variant example:

HPR100GØ16.350-7MC1G-HC419

Special tool diameter d₁ = 16.350 -7 µm

Dimensions in mm.

* for surfaces R_a > 2 µm

For associated HFS replaceable head holders, see page 460.

For cutting data recommendations, see end of chapter.



HPR replaceable head reamer

Fixed design, straight fluted, for through bores
HPR100

Design:

Reamer diameter:
Lead:
Cutting material:

15.600-65.000 mm
MC1G
HP421
Carbide
PVD-coated

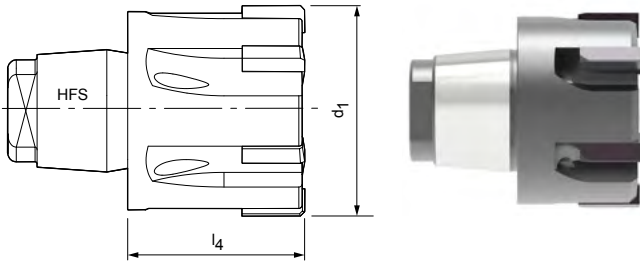

Preferred series in H7

d ₁ H7	HFS size	Dimensions		Specification	Order no.
		l ₄	z		
19,000	12	14,5	6	HPR100Ø19H7MC1G-HP421	30037777
20,000	12	14,5	6	HPR100Ø20H7MC1G-HP421	30191340
22,000	14	15,5	6	HPR100Ø22H7MC1G-HP421	30368857
24,000	16	16	6	HPR100Ø24H7MC1G-HP421	30181729
25,000	16	16	6	HPR100Ø25H7MC1G-HP421	30537929
26,000	16	16	6	HPR100Ø26H7MC1G-HP421	30076945
28,000	16	16	6	HPR100Ø28H7MC1G-HP421	30025212
30,000	20	17	8	HPR100Ø30H7MC1G-HP421	30031345
32,000	20	17	8	HPR100Ø32H7MC1G-HP421	30438453
35,000	20	17	8	HPR100Ø35H7MC1G-HP421	30537930
40,000	24	19	8	HPR100Ø40H7MC1G-HP421	30083953
45,000	24	19	8	HPR100Ø45H7MC1G-HP421	30537931
50,000	24	19	8	HPR100Ø50H7MC1G-HP421	30710245
55,000	24	25	8	HPR100Ø55H7MC1G-HP421	30419154
60,000	24	25	8	HPR100Ø60H7MC1G-HP421	30350208
65,000	24	25	8	HPR100Ø65H7MC1G-HP421	30272888

Dimensions in mm.
For associated HFS replaceable head holders, see page 460.
For cutting data recommendations, see end of chapter.

HPR100 | Fixed design, straight fluted

Configurable features

**Bore diameter tolerance IT6/IT7:**

- Diameter freely selectable in increments of 0.001 mm
- Can be ordered from tolerance IT6/IT7 depending on the diameter range
- > $\emptyset 30.000$ IT6 | $\leq \emptyset 30.000$ IT7

**Specification:**HPR100 \emptyset [diameter][tolerance]MC1G-HP421**Bore diameter tolerance < IT6/IT7:**

- Tolerances smaller than IT6/IT7 can be ordered as a special tool diameter (G variant, see page 373)

G variant specification:HPR100G \emptyset [diameter][tolerance]MC1G-HP421

Dimensions of configurable series IT6/IT7

d1	l ₄	l ₅	HFS size	z	Tolerance
15,600 - 18,590	14	-	10	6	IT7
18,600 - 21,290	14,5	-	12	6	IT7
21,300 - 23,990	15,5	-	14	6	IT7
24,000 - 29,990	16	-	16	6	IT7
30,000 - 39,990	17	-	20	8	IT6
40,000 - 50,700	19	-	24	8	IT6
50,710 - 65,000	25	-	24	8	IT6

IT7 tolerance example:HPR100 \emptyset 16.350H7MC1G-HP421Bore diameter $d_1 = 16.350$ H7**G variant example:**HPR100G \emptyset 16.350-5MC1G-HP421Special tool diameter $d_1 = 16.350 -5 \mu\text{m}$

HPR replaceable head reamer

Fixed design, straight fluted, for through bores
HPR100

Design:

Reamer diameter:
Lead:
Cutting material:

15.600-65.000 mm
MC1G
HP423
Carbide
PVD-coated

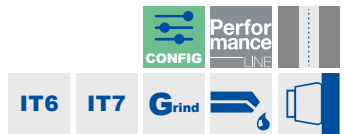
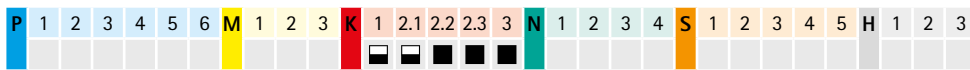
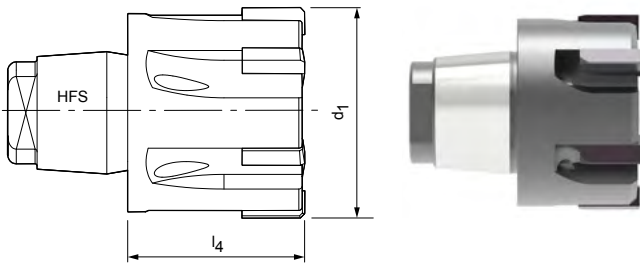

Configurable features



Bore diameter tolerance IT6/IT7:

- Diameter freely selectable in increments of 0.001 mm
- Can be ordered from tolerance IT6/IT7 depending on the diameter range
- > Ø30.000 IT6 | ≤ Ø30.000 IT7

Specification:

HPR100Ø[diameter][tolerance]MC1G-HP423

Bore diameter tolerance < IT6/IT7:

- Tolerances smaller than IT6/IT7 can be ordered as a special tool diameter (G variant, see page 373)

G variant specification:

HPR100GØ[diameter][tolerance]MC1G-HP423

Dimensions of configurable series IT6/IT7

d1	l4	l5	HFS size	z	Tolerance
15,600 - 18,590	14	-	10	6	IT7
18,600 - 21,290	14,5	-	12	6	IT7
21,300 - 23,990	15,5	-	14	6	IT7
24,000 - 29,990	16	-	16	6	IT7
30,000 - 39,990	17	-	20	8	IT6
40,000 - 50,700	19	-	24	8	IT6
50,710 - 65,000	25	-	24	8	IT6

IT7 tolerance example:

HPR100Ø16.350H7MC1G-HP423

Bore diameter d₁ = 16.350 H7

G variant example:

HPR100GØ16.350-8MC1G-HP423

Special tool diameter d₁ = 16.350 -7 µm

Dimensions in mm.

For associated HFS replaceable head holders, see page 460.

For cutting data recommendations, see end of chapter.

HPR replaceable head reamer

Fixed design, straight fluted, for through bores
HPR100

Design:

Reamer diameter:

15.600-65.000 mm

Lead:

MA0A

Cutting material:

PU620

PCD-tipped

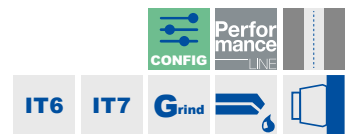
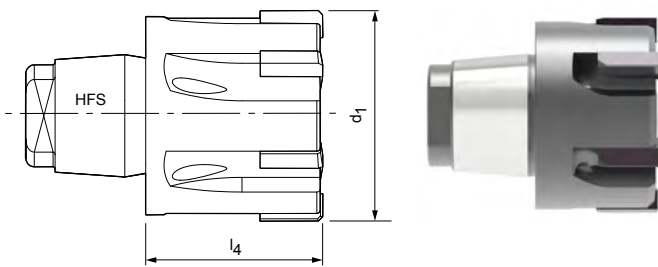

Configurable features

Bore diameter tolerance IT6/IT7:

- Diameter freely selectable in increments of 0.001 mm
- Can be ordered from tolerance IT6/IT7 depending on the diameter range
- > $\varnothing 30.000$ IT6 | $\leq \varnothing 30.000$ IT7

Specification:

HPR100 \varnothing [diameter][tolerance]MA0A-PU620

Bore diameter tolerance < IT6/IT7:

- Tolerances smaller than IT6/IT7 can be ordered as a special tool diameter (G variant, see page 373)

G variant specification:

HPR100G \varnothing [diameter][tolerance]MA0A-PU620

Dimensions of configurable series IT6/IT7

d1	l ₄	l ₅	HFS size	z	Tolerance
15,600 - 18,590	14	-	10	6	IT7
18,600 - 21,290	14,5	-	12	6	IT7
21,300 - 23,990	15,5	-	14	6	IT7
24,000 - 29,990	16	-	16	6	IT7
30,000 - 39,990	17	-	20	8	IT6
40,000 - 50,700	19	-	24	8	IT6
50,710 - 65,000	25	-	24	8	IT6

IT7 tolerance example:

HPR100 \varnothing 16.350H7MA0A-PU620

Bore diameter $d_1 = 16.350$ H7

G variant example:

HPR100G \varnothing 16.350-3MA0A-PU620

Special tool diameter $d_1 = 16.350 -3 \mu\text{m}$

Dimensions in mm.

For associated HFS replaceable head holders, see page 460.

For cutting data recommendations, see end of chapter.

HPR replaceable head reamer

Fixed design, left-hand fluted, for through bores
HPR110

Design:

Reamer diameter:
Lead:
Cutting material:

15.600-65.000 mm
ME1G
CU134
Uncoated cermet

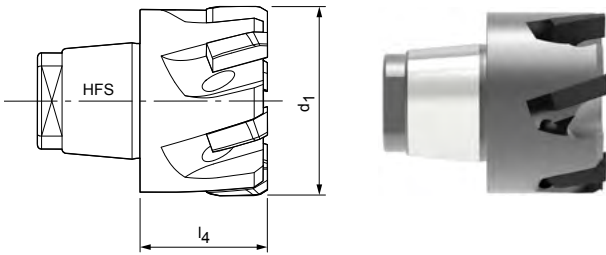

Preferred series in H7

d ₁ H7	HFS size	Dimensions		Specification	Order no.
		l ₄	z		
19,000	12	14,5	6	HPR110Ø19H7ME1G-CU134	30077358
20,000	12	14,5	6	HPR110Ø20H7ME1G-CU134	30040404
21,000	12	14,5	6	HPR110Ø21H7ME1G-CU134	30039919
22,000	14	15,5	6	HPR110Ø22H7ME1G-CU134	30081546
23,000	14	15,5	6	HPR110Ø23H7ME1G-CU134	30085368
24,000	16	16	6	HPR110Ø24H7ME1G-CU134	30080958
25,000	16	16	6	HPR110Ø25H7ME1G-CU134	30076110
26,000	16	16	6	HPR110Ø26H7ME1G-CU134	30045730
27,000	16	16	6	HPR110Ø27H7ME1G-CU134	30087257
28,000	16	16	6	HPR110Ø28H7ME1G-CU134	30046121
30,000	20	17	8	HPR110Ø30H7ME1G-CU134	30045095
31,000	20	17	8	HPR110Ø31H7ME1G-CU134	30192960
32,000	20	17	8	HPR110Ø32H7ME1G-CU134	30084530
33,000	20	17	8	HPR110Ø33H7ME1G-CU134	30162282
34,000	20	17	8	HPR110Ø34H7ME1G-CU134	30043743
35,000	20	17	8	HPR110Ø35H7ME1G-CU134	30084885
39,000	20	17	8	HPR110Ø39H7ME1G-CU134	30088042
40,000	24	19	8	HPR110Ø40H7ME1G-CU134	30045097
42,000	24	19	8	HPR110Ø42H7ME1G-CU134	30080437
44,000	24	19	8	HPR110Ø44H7ME1G-CU134	30097178
45,000	24	19	8	HPR110Ø45H7ME1G-CU134	30049313
50,000	24	19	8	HPR110Ø50H7ME1G-CU134	30219386
55,000	24	25	8	HPR110Ø55H7ME1G-CU134	30196567
60,000	24	25	8	HPR110Ø60H7ME1G-CU134	30242416
65,000	24	25	8	HPR110Ø65H7ME1G-CU134	30236537

Dimensions in mm.
For associated HFS replaceable head holders, see page 460.
For cutting data recommendations, see end of chapter.

HPR110 | Fixed design, left-hand fluted

Configurable features

**Bore diameter tolerance IT6/IT7:**

- Diameter freely selectable in increments of 0.001 mm
- Can be ordered from tolerance IT6/IT7 depending on the diameter range
- > $\varnothing 30.000$ IT6 | $\leq \varnothing 30.000$ IT7

**Specification:**HPR110 \varnothing [diameter][tolerance]ME1G-CU134**Bore diameter tolerance < IT6/IT7:**

- Tolerances smaller than IT6/IT7 can be ordered as a special tool diameter (G variant, see page 373)

G variant specification:HPR110G \varnothing [diameter][tolerance]ME1G-CU134

Dimensions of configurable series IT6/IT7

d1	l ₄	l ₅	HFS size	z	Tolerance
15,600 - 18,590	14	-	10	6	IT7
18,600 - 21,290	14,5	-	12	6	IT7
21,300 - 23,990	15,5	-	14	6	IT7
24,000 - 29,990	16	-	16	6	IT7
30,000 - 39,990	17	-	20	8	IT6
40,000 - 50,700	19	-	24	8	IT6
50,710 - 65,000	25	-	24	8	IT6

IT7 tolerance example:HPR110 \varnothing 16.350H7ME1G-CU134Bore diameter $d_1 = 16.350$ H7**G variant example:**HPR110G \varnothing 16.350-3ME1G-CU134Special tool diameter $d_1 = 16.350 -3 \mu\text{m}$

HPR replaceable head reamer

Fixed design, left-hand fluted, for through bores
HPR110

Design:

Reamer diameter:
Lead:
Cutting material:

15.600-65.000 mm
ME1G
HP421
Carbide
PVD-coated

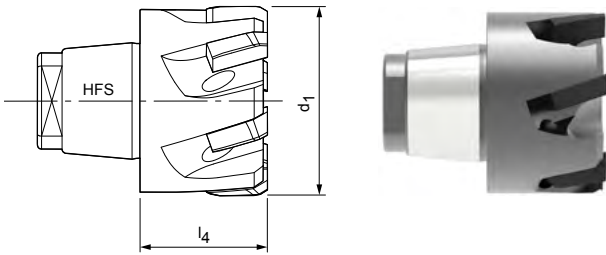

Configurable features



Bore diameter tolerance IT6/IT7:

- Diameter freely selectable in increments of 0.001 mm
- Can be ordered from tolerance IT6/IT7 depending on the diameter range
- > Ø30.000 IT6 | ≤ Ø30.000 IT7

Specification:

HPR110Ø[diameter][tolerance]ME1G-HP421

Bore diameter tolerance < IT6/IT7:

- Tolerances smaller than IT6/IT7 can be ordered as a special tool diameter (G variant, see page 373)

G variant specification:

HPR110GØ[diameter][tolerance]ME1G-HP421

Dimensions of configurable series IT6/IT7

d1	l4	l5	HFS size	z	Tolerance
15,600 - 18,590	14	-	10	6	IT7
18,600 - 21,290	14,5	-	12	6	IT7
21,300 - 23,990	15,5	-	14	6	IT7
24,000 - 29,990	16	-	16	6	IT7
30,000 - 39,990	17	-	20	8	IT6
40,000 - 50,700	19	-	24	8	IT6
50,710 - 65,000	25	-	24	8	IT6

IT7 tolerance example:

HPR110Ø16.350H7ME1G-HP421

Bore diameter d₁ = 16.350 H7

G variant example:

HPR110GØ16.350-5ME1G-HP421

Special tool diameter d₁ = 16.350 -5 µm

Dimensions in mm.

For associated HFS replaceable head holders, see page 460.

For cutting data recommendations, see end of chapter.

HPR replaceable head reamer

Fixed design, left-hand fluted, for through bores
HPR110

Design:

Reamer diameter: 15.600-65.000 mm
Lead: MF1G
Cutting material: HP625
Carbide
PVD-coated

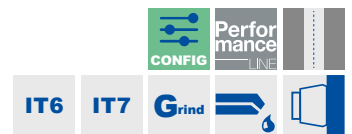
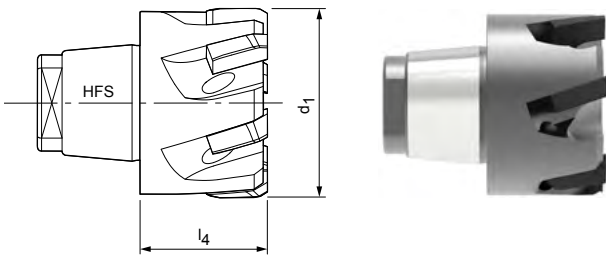

Configurable features

Bore diameter tolerance IT6/IT7:

- Diameter freely selectable in increments of 0.001 mm
- Can be ordered from tolerance IT6/IT7 depending on the diameter range
- > $\varnothing 30.000$ IT6 | $\leq \varnothing 30.000$ IT7

Specification:

HPR110 \varnothing [diameter][tolerance]MF1G-HP625

Bore diameter tolerance < IT6/IT7:

- Tolerances smaller than IT6/IT7 can be ordered as a special tool diameter (G variant, see page 373)

G variant specification:

HPR110G \varnothing [diameter][tolerance]MF1G-HP625

Dimensions of configurable series IT6/IT7

d1	l ₄	l ₅	HFS size	z	Tolerance
15,600 - 18,590	14	-	10	6	IT7
18,600 - 21,290	14,5	-	12	6	IT7
21,300 - 23,990	15,5	-	14	6	IT7
24,000 - 29,990	16	-	16	6	IT7
30,000 - 39,990	17	-	20	8	IT6
40,000 - 50,700	19	-	24	8	IT6
50,710 - 65,000	25	-	24	8	IT6

IT7 tolerance example:

HPR110 \varnothing 16.350H7MF1G-HP625

Bore diameter $d_1 = 16.350$ H7

G variant example:

HPR110G \varnothing 16.350-7MF1G-HP625

Special tool diameter $d_1 = 16.350 -5 \mu\text{m}$

Dimensions in mm.

For associated HFS replaceable head holders, see page 460.

For cutting data recommendations, see end of chapter.

HPR replaceable head reamer

Fixed design, left-hand fluted, for through bores
HPR110

Design:

Reamer diameter:

15.600-65.000 mm

Lead:

MF1G

Cutting material:

HP421

Carbide

PVD-coated

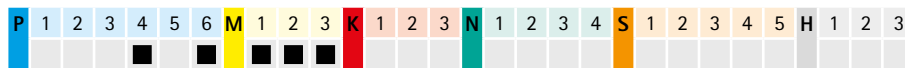
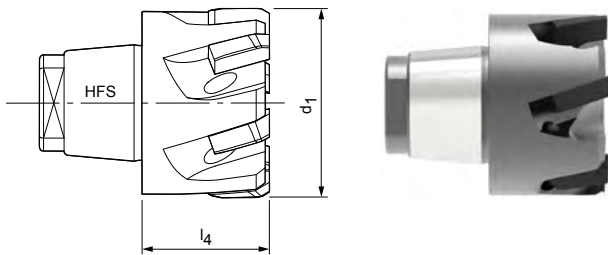
Preferred series in H7

d ₁ H7	HFS size	Dimensions		Specification	Order no.
		l ₄	z		
19,000	12	14,5	6	HPR110Ø19H7MF1G-HP421	30710291
20,000	12	14,5	6	HPR110Ø20H7MF1G-HP421	30401369
22,000	14	15,5	6	HPR110Ø22H7MF1G-HP421	30710293
23,000	14	15,5	6	HPR110Ø23H7MF1G-HP421	30710294
24,000	16	16	6	HPR110Ø24H7MF1G-HP421	30710295
25,000	16	16	6	HPR110Ø25H7MF1G-HP421	30318503
26,000	16	16	6	HPR110Ø26H7MF1G-HP421	30710296
27,000	16	16	6	HPR110Ø27H7MF1G-HP421	30710297
28,000	16	16	6	HPR110Ø28H7MF1G-HP421	30710298
30,000	20	17	8	HPR110Ø30H7MF1G-HP421	30576508
31,000	20	17	8	HPR110Ø31H7MF1G-HP421	30710300
32,000	20	17	8	HPR110Ø32H7MF1G-HP421	30671985
33,000	20	17	8	HPR110Ø33H7MF1G-HP421	30710301
34,000	20	17	8	HPR110Ø34H7MF1G-HP421	30710302
35,000	20	17	8	HPR110Ø35H7MF1G-HP421	30710303
39,000	20	17	8	HPR110Ø39H7MF1G-HP421	30710307
40,000	24	19	8	HPR110Ø40H7MF1G-HP421	30498368

Dimensions in mm.

For associated HFS replaceable head holders, see page 460.

For cutting data recommendations, see end of chapter.

HPR110 | Fixed design, left-hand fluted

Configurable features

**Bore diameter tolerance IT6/IT7:**

- Diameter freely selectable in increments of 0.001 mm
- Can be ordered from tolerance IT6/IT7 depending on the diameter range
- > $\varnothing 30.000$ IT6 | $\leq \varnothing 30.000$ IT7

**Specification:**HPR110 \varnothing [diameter][tolerance]MF1G-HP421**Bore diameter tolerance < IT6/IT7:**

- Tolerances smaller than IT6/IT7 can be ordered as a special tool diameter (G variant, see page 373)

G variant specification:HPR110G \varnothing [diameter][tolerance]MF1G-HP421

Dimensions of configurable series IT6/IT7

d1	l ₄	l ₅	HFS size	z	Tolerance
15,600 - 18,590	14	-	10	6	IT7
18,600 - 21,290	14,5	-	12	6	IT7
21,300 - 23,990	15,5	-	14	6	IT7
24,000 - 29,990	16	-	16	6	IT7
30,000 - 39,990	17	-	20	8	IT6
40,000 - 50,700	19	-	24	8	IT6
50,710 - 65,000	25	-	24	8	IT6

IT7 tolerance example:HPR110 \varnothing 16.350H7MF1G-HP421Bore diameter d₁ = 16.350 H7**G variant example:**HPR110G \varnothing 16.350-5MF1G-HP421Special tool diameter d₁ = 16.350 -5 μ m

HPR replaceable head reamer

Fixed design, straight fluted, for blind bores
HPR180

Design:

Reamer diameter:
Lead:
Cutting material:

7.000-21.290 mm
ML2G
CU134
Uncoated cermet

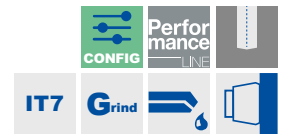
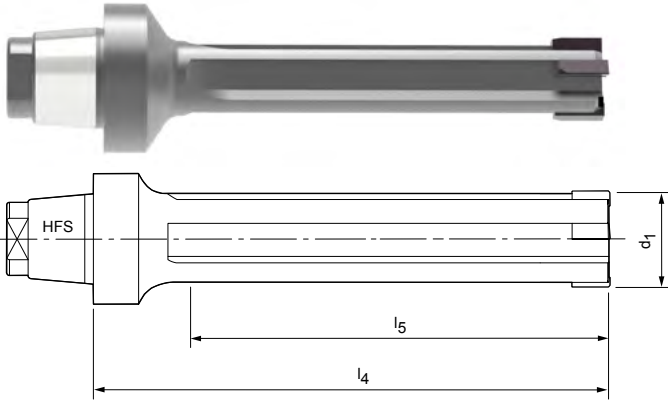

Configurable features



Bore diameter tolerance IT7:
- Diameter freely selectable in increments of 0.001 mm
- Can be ordered from tolerance IT7

Specification:
HPR180Ø[diameter][tolerance]ML2G-CU134

Bore diameter tolerance < IT7:
- Tolerances smaller than IT7 can be ordered as a special tool diameter (G variant, see page 373)

G variant specification:
HPR180GØ[diameter][tolerance]ML2G-CU134

Dimensions of configurable series IT7

d1	l4	l5	HFS size	z
7,000 - 14,590	60	40	12	4
14,600 - 21,290	60	40	12	6

IT7 tolerance example:
HPR180Ø16.350H7ML2G-CU134

Bore diameter d₁ = 16.350 H7

G variant example:
HPR180GØ16.350-3ML2G-CU134

Special tool diameter d₁ = 16.350 -3 µm

Dimensions in mm.
For associated HFS replaceable head holders, see page 460.
For cutting data recommendations, see end of chapter.

HPR replaceable head reamer

Fixed design, straight fluted, for blind bores
HPR180

Design:

Reamer diameter: 7.000–21.290 mm
Lead: ML2G
Cutting material: HP421
Carbide
PVD-coated

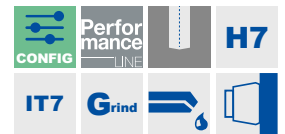
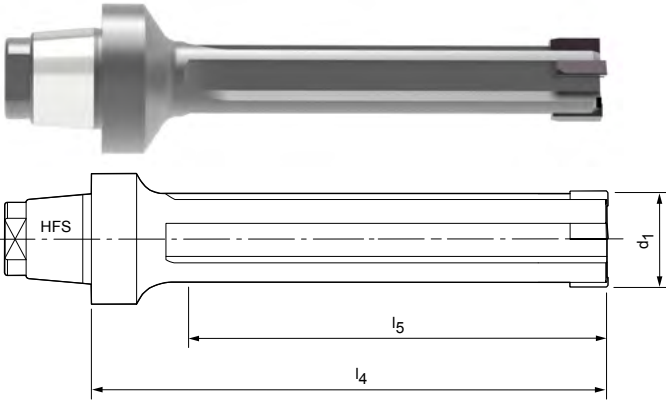

Preferred series in H7

d ₁ H7	HFS size	Dimensions			Specification	Order no.
		l ₄	l ₅	z		
10,000	12	60	40	4	HPR180Ø10H7ML2G-HP421	30710208
12,000	12	60	40	4	HPR180Ø12H7ML2G-HP421	30710210
14,000	12	60	40	4	HPR180Ø14H7ML2G-HP421	30710212
16,000	12	60	40	6	HPR180Ø16H7ML2G-HP421	30710214
18,000	12	60	40	6	HPR180Ø18H7ML2G-HP421	30710216
19,000	12	60	40	6	HPR180Ø19H7ML2G-HP421	30710217
20,000	12	60	40	6	HPR180Ø20H7ML2G-HP421	30710218

Configurable features



Bore diameter tolerance IT7:

- Diameter freely selectable in increments of 0.001 mm
- Can be ordered from tolerance IT7

Specification:

HPR180Ø[diameter][tolerance]ML2G-HP421

Bore diameter tolerance < IT7:

- Tolerances smaller than IT7 can be ordered as a special tool diameter (G variant, see page 373)

G variant specification:

HPR180GØ[diameter][tolerance]ML2G-HP421

Dimensions of configurable series IT7

d ₁	l ₄	l ₅	HFS size	z
7,000 - 14,590	60	40	12	4
14,600 - 21,290	60	40	12	6

IT7 tolerance example:

HPR180Ø16.350H7ML2G-HP421

Bore diameter d₁ = 16.350 H7

G variant example:

HPR180GØ16.350-5ML2G-HP421

Special tool diameter d₁ = 16.350 -5 µm

Dimensions in mm.

For associated HFS replaceable head holders, see page 460.

For cutting data recommendations, see end of chapter.

HPR replaceable head reamer

Fixed design, straight fluted, for blind bores
HPR180

Design:

Reamer diameter:
Lead:
Cutting material:

7.000-21.290 mm
M02G
HP421
Carbide
PVD-coated

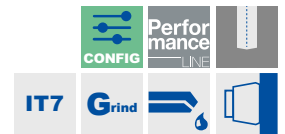
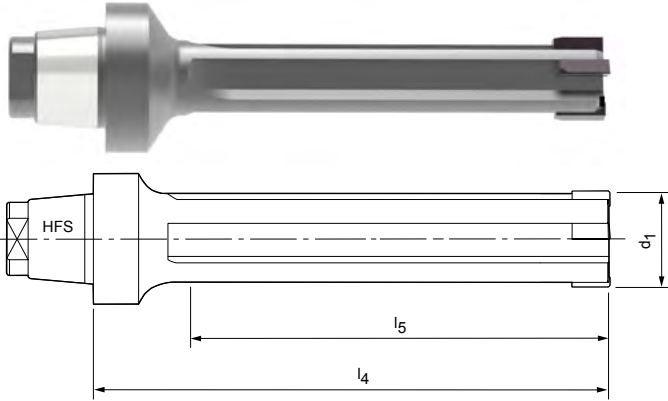

Configurable features



Bore diameter tolerance IT7:
- Diameter freely selectable in increments of 0.001 mm
- Can be ordered from tolerance IT7

Specification:
HPR180Ø[diameter][tolerance]M02G-HP421

Bore diameter tolerance < IT7:
- Tolerances smaller than IT7 can be ordered as a special tool diameter (G variant, see page 373)

G variant specification:
HPR180GØ[diameter][tolerance]M02G-HP421

Dimensions of configurable series IT7

d1	l4	l5	HFS size	z
7,000 - 14,590	60	40	12	4
14,600 - 21,290	60	40	12	6

IT7 tolerance example:
HPR180Ø16.350H7M02G-HP421

Bore diameter d₁ = 16.350 H7

G variant example:
HPR180GØ16.350-5M02G-HP421

Special tool diameter d₁ = 16.350 -5 µm

Dimensions in mm.
For associated HFS replaceable head holders, see page 460.
For cutting data recommendations, see end of chapter.

HPR replaceable head reamer

Fixed design, straight fluted, for blind bores
HPR180

Design:

Reamer diameter: 7.000–21.290 mm
Lead: MC1G
Cutting material: CP134
Cermet
PVD-coated

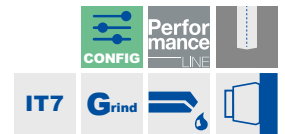
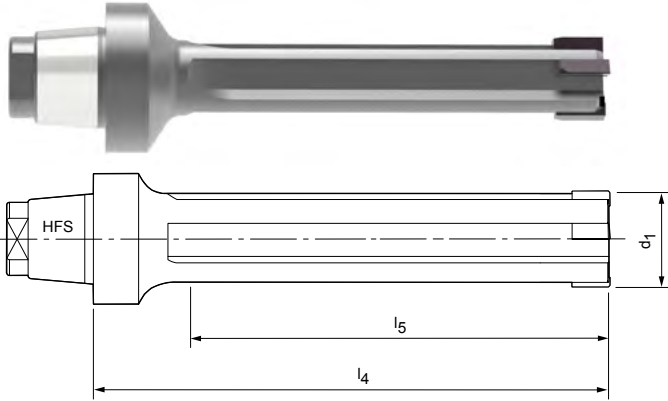

Configurable features



Bore diameter tolerance IT7:

- Diameter freely selectable in increments of 0.001 mm
- Can be ordered from tolerance IT7

Specification:

HPR180Ø[diameter][tolerance]MC1G-CP134

Bore diameter tolerance < IT7:

- Tolerances smaller than IT7 can be ordered as a special tool diameter (G variant, see page 373)

G variant specification:

HPR180GØ[diameter][tolerance]MC1G-CP134

Dimensions of configurable series IT7

d1	l ₄	l ₅	HFS size	z
7,000 - 14,590	60	40	12	4
14,600 - 21,290	60	40	12	6

IT7 tolerance example:

HPR180Ø16.350H7MC1G-CP134

Bore diameter $d_1 = 16.350 \text{ H7}$

G variant example:

HPR180GØ16.350-5MC1G-CP134

Special tool diameter $d_1 = 16.350 -5 \mu\text{m}$

Dimensions in mm.

* for surfaces $R_a < 2 \mu\text{m}$

For associated HFS replaceable head holders, see page 460.

For cutting data recommendations, see end of chapter.

HPR replaceable head reamer

Fixed design, straight fluted, for blind bores
HPR180

Design:

Reamer diameter:
Lead:
Cutting material:

7.000–21.290 mm
MC1G
HC419
Solid carbide
CVD-coated

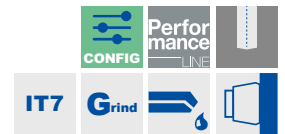
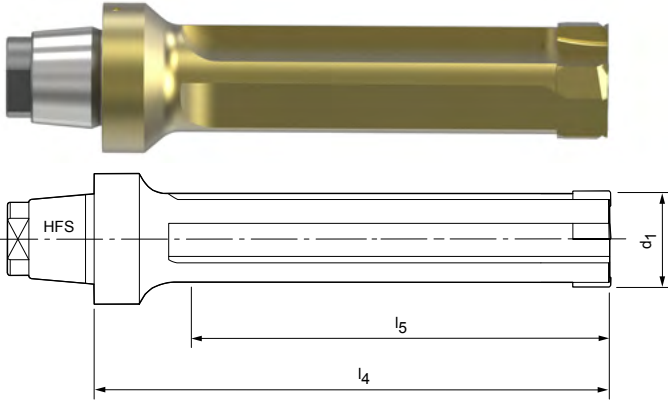

Configurable features



Bore diameter tolerance IT7:
- Diameter freely selectable in increments of 0.001 mm
- Can be ordered from tolerance IT7

Specification:
HPR180Ø[diameter][tolerance]MC1G-HC419

Bore diameter tolerance < IT7:
- Tolerances smaller than IT7 can be ordered as a special tool diameter (G variant, see page 373)

G variant specification:
HPR180GØ[diameter][tolerance]MC1G-HC419

Dimensions of configurable series IT7

d1	l4	l5	HFS size	z
7,000 - 14,590	60	40	12	4
14,600 - 21,290	60	40	12	6

IT7 tolerance example:
HPR180Ø16.350H7MC1G-HC419

Bore diameter $d_1 = 16.350 H7$

G variant example:
HPR180GØ16.350-7MC1G-HC419

Special tool diameter $d_1 = 16.350 -7 \mu m$

Dimensions in mm.

* for surfaces $R_a > 2 \mu m$

For associated HFS replaceable head holders, see page 460.

For cutting data recommendations, see end of chapter.

HPR replaceable head reamer

Fixed design, straight fluted, for blind bores
HPR180

Design:

Reamer diameter: 7.000–21.290 mm
Lead: MC1G
Cutting material: HP421
Carbide
PVD-coated

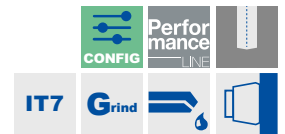
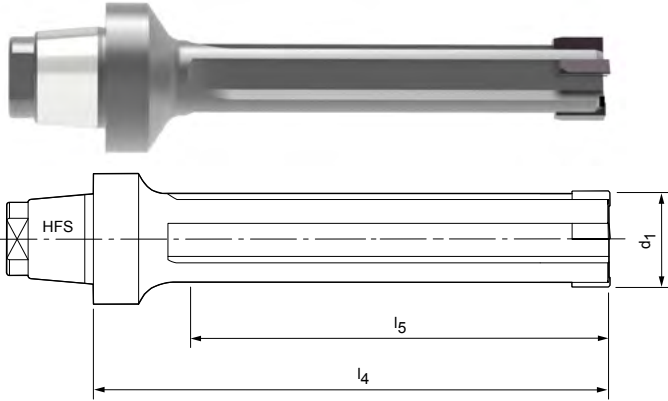

Configurable features



Bore diameter tolerance IT7:

- Diameter freely selectable in increments of 0.001 mm
- Can be ordered from tolerance IT7

Specification:

HPR180Ø[diameter][tolerance]MC1G-HP421

Bore diameter tolerance < IT7:

- Tolerances smaller than IT7 can be ordered as a special tool diameter (G variant, see page 373)

G variant specification:

HPR180GØ[diameter][tolerance]MC1G-HP421

Dimensions of configurable series IT7

d1	l ₄	l ₅	HFS size	z
7,000 - 14,590	60	40	12	4
14,600 - 21,290	60	40	12	6

IT7 tolerance example:

HPR180Ø16.350H7MC1G-HP421

Bore diameter $d_1 = 16.350 \text{ H7}$

G variant example:

HPR180GØ16.350-5MC1G-HP421

Special tool diameter $d_1 = 16.350 -5 \mu\text{m}$

Dimensions in mm.

For associated HFS replaceable head holders, see page 460.

For cutting data recommendations, see end of chapter.

HPR replaceable head reamer

Fixed design, straight fluted, for blind bores
HPR180

Design:

Reamer diameter:
Lead:
Cutting material:

7.000–21.290 mm
MC1G
HP423
Carbide
PVD-coated

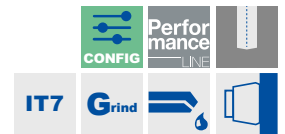
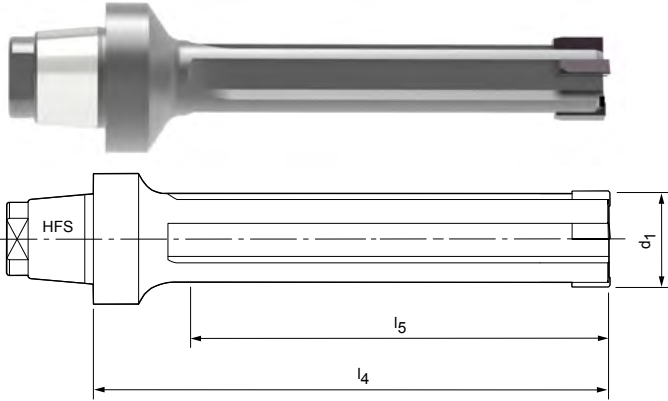

Configurable features



Bore diameter tolerance IT7:
- Diameter freely selectable in increments of 0.001 mm
- Can be ordered from tolerance IT7

Specification:
HPR180Ø[diameter][tolerance]MC1G-HP423

Bore diameter tolerance < IT7:
- Tolerances smaller than IT7 can be ordered as a special tool diameter (G variant, see page 373)

G variant specification:
HPR180GØ[diameter][tolerance]MC1G-HP423

Dimensions of configurable series IT7

d1	l4	l5	HFS size	z
7,000 - 14,590	60	40	12	4
14,600 - 21,290	60	40	12	6

IT7 tolerance example:
HPR180Ø16.350H7MC1G-HP423

Bore diameter d₁ = 16.350 H7

G variant example:
HPR180GØ16.350-8MC1G-HP423

Special tool diameter d₁ = 16.350 -7 µm

Dimensions in mm.
For associated HFS replaceable head holders, see page 460.
For cutting data recommendations, see end of chapter.

HPR replaceable head reamer

Fixed design, straight fluted, for blind bores
HPR180

Design:

Reamer diameter:

7.000–21.290 mm

Lead:

MA0A

Cutting material:

PU620

PCD-tipped

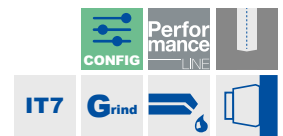
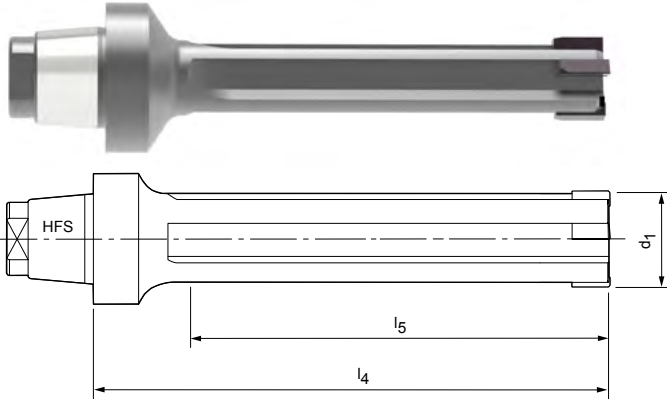

Configurable features

Bore diameter tolerance IT7:

- Diameter freely selectable in increments of 0.001 mm
- Can be ordered from tolerance IT7

Specification:

HPR180Ø[diameter][tolerance]MA0A-PU620

Bore diameter tolerance < IT7:

- Tolerances smaller than IT7 can be ordered as a special tool diameter (G variant, see page 373)

G variant specification:

HPR180GØ[diameter][tolerance]MA0A-PU620

Dimensions of configurable series IT7

d1	l ₄	l ₅	HFS size	z
7,000 - 14,590	60	40	12	4
14,600 - 21,290	60	40	12	6

IT7 tolerance example:

HPR180Ø16.350H7MA0A-PU620

Bore diameter $d_1 = 16.350 \text{ H7}$

G variant example:

HPR180GØ16.350-3MA0A-PU620

Special tool diameter $d_1 = 16.350 -3 \mu\text{m}$

Dimensions in mm.

For associated HFS replaceable head holders, see page 460.

For cutting data recommendations, see end of chapter.

HPR replaceable head reamer

Fixed design, straight fluted, for blind bores
HPR180

Design:

Reamer diameter:
Lead:
Cutting material:

7.000-21.290 mm
M02G
HP625
Carbide
PVD-coated

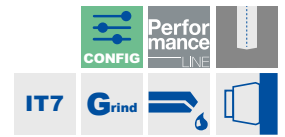
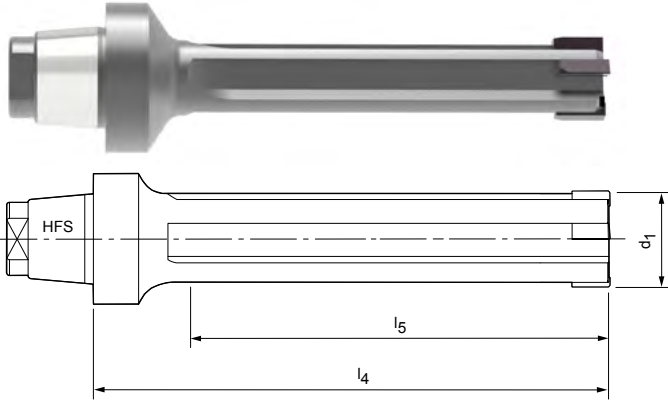

Configurable features



Bore diameter tolerance IT7:
- Diameter freely selectable in increments of 0.001 mm
- Can be ordered from tolerance IT7

Specification:
HPR180Ø[diameter][tolerance]M02G-HP625

Bore diameter tolerance < IT7:
- Tolerances smaller than IT7 can be ordered as a special tool diameter (G variant, see page 373)

G variant specification:
HPR180GØ[diameter][tolerance]M02G-HP625

Dimensions of configurable series IT7

d1	l4	l5	HFS size	z
7,000 - 14,590	60	40	12	4
14,600 - 21,290	60	40	12	6

IT7 tolerance example:
HPR180Ø16.350H7M02G-HP625

Bore diameter d₁ = 16.350 H7

G variant example:
HPR180GØ16.350-7M02G-HP625

Special tool diameter d₁ = 16.350 -5 µm

Dimensions in mm.
For associated HFS replaceable head holders, see page 460.
For cutting data recommendations, see end of chapter.

HPR replaceable head reamer

Fixed design, straight fluted, for blind bores
HPR150

Design:

Reamer diameter: 16.600-65.000 mm
Lead: ML2G
Cutting material: CU134
Uncoated cermet

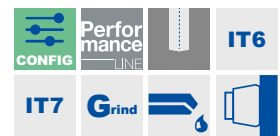
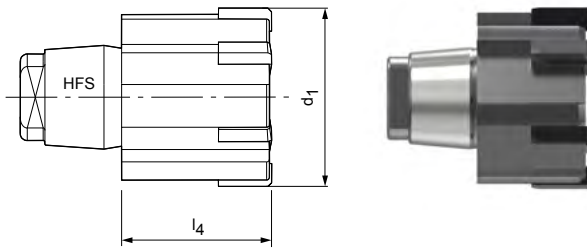

Configurable features

Bore diameter tolerance IT6/IT7:

- Diameter freely selectable in increments of 0.001 mm
- Can be ordered from tolerance IT6/IT7 depending on the diameter range
- > $\varnothing 30.000$ IT6 | $\leq \varnothing 30.000$ IT7

Specification:

HPR150 \varnothing [diameter][tolerance]ML2G-CU134

Bore diameter tolerance < IT6/IT7:

- Tolerances smaller than IT6/IT7 can be ordered as a special tool diameter (G variant, see page 373)

G variant specification:

HPR150G \varnothing [diameter][tolerance]ML2G-CU134

Dimensions of configurable series IT6/IT7

d1	l ₄	l ₅	HFS size	z	Tolerance
16,600 - 21,290	14	-	10	6	IT7
21,300 - 24,990	15,5	-	12	6	IT7
25,000 - 28,990	15,5	-	14	6	IT7
29,000 - 29,990	17	-	16	6	IT7
30,000 - 36,990	17	-	16	6	IT6
37,000 - 44,990	17	-	20	8	IT6
45,000 - 50,700	19	-	24	8	IT6
50,710 - 65,000	25	-	24	8	IT6

IT6 tolerance example:

HPR150 \varnothing 37.350H6ML2G-CU134

Bore diameter $d_1 = 37.350$ H6

G variant example:

HPR150G \varnothing 37.350-3ML2G-CU134

Special tool diameter $d_1 = 37.350 -3 \mu\text{m}$

Dimensions in mm.

For associated HFS replaceable head holders, see page 460.

For cutting data recommendations, see end of chapter.

HPR replaceable head reamer

Fixed design, straight fluted, for blind bores
HPR150

Design:

Reamer diameter: 16.600-65.000 mm
Lead: ML2G
Cutting material: HP421
Carbide
PVD-coated

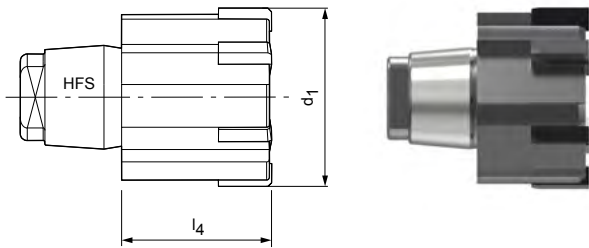

Preferred series in H7

d ₁ H7	HFS size	Dimensions		Specification	Order no.
		l ₄	z		
22,000	12	15,5	6	HPR150Ø22H7ML2G-HP421	30098915
24,000	12	15,5	6	HPR150Ø24H7ML2G-HP421	30329443
26,000	14	15,5	6	HPR150Ø26H7ML2G-HP421	30044823
28,000	14	15,5	6	HPR150Ø28H7ML2G-HP421	30710391
30,000	16	17	6	HPR150Ø30H7ML2G-HP421	30710393
32,000	16	17	6	HPR150Ø32H7ML2G-HP421	30462441
40,000	20	17	8	HPR150Ø40H7ML2G-HP421	30586834

Configurable features

Bore diameter tolerance IT6/IT7:

- Diameter freely selectable in increments of 0.001 mm
- Can be ordered from tolerance IT6/IT7 depending on the diameter range
- > Ø30.000 IT6 | ≤ Ø30.000 IT7

Specification:
HPR150Ø[diameter][tolerance]ML2G-HP421

Bore diameter tolerance < IT6/IT7:

- Tolerances smaller than IT6/IT7 can be ordered as a special tool diameter (G variant, see page 373)

G variant specification:
HPR150GØ[diameter][tolerance]ML2G-HP421

Dimensions of configurable series IT6/IT7

d ₁	l ₄	l ₅	HFS size	z	Tolerance
16,600 - 21,290	14	-	10	6	IT7
21,300 - 24,990	15,5	-	12	6	IT7
25,000 - 28,990	15,5	-	14	6	IT7
29,000 - 29,990	17	-	16	6	IT7
30,000 - 36,990	17	-	16	6	IT6
37,000 - 44,990	17	-	20	8	IT6
45,000 - 50,700	19	-	24	8	IT6
50,710 - 65,000	25	-	24	8	IT6

IT6 tolerance example:
HPR150Ø37.350H6ML2G-HP421

Bore diameter d₁ = 37.350 H6

G variant example:
HPR150GØ37.350-5ML2G-HP421

Special tool diameter d₁ = 37.350 -5 µm

Dimensions in mm.
For associated HFS replaceable head holders, see page 460.
For cutting data recommendations, see end of chapter.

HPR replaceable head reamer

Fixed design, straight fluted, for blind bores
HPR150

Design:

Reamer diameter: 16.600-65.000 mm
Lead: M02G
Cutting material: HP421
Carbide
PVD-coated

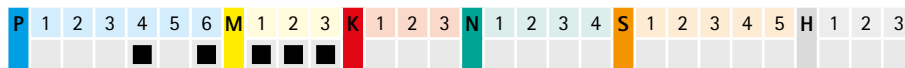
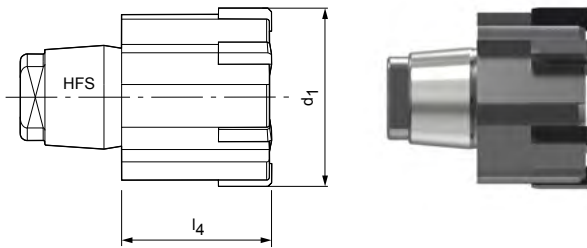

Preferred series in H7

d ₁ H7	HFS size	Dimensions		Specification	Order no.
		l ₄	z		
20,000	10	14	6	HPR150Ø20H7M02G-HP421	30975790
26,000	14	15,5	6	HPR150Ø26H7M02G-HP421	30975773
28,000	14	15,5	6	HPR150Ø28H7M02G-HP421	30843363
30,000	16	17	6	HPR150Ø30H7M02G-HP421	30975775
32,000	16	17	6	HPR150Ø32H7M02G-HP421	30975776
35,000	16	17	6	HPR150Ø35H7M02G-HP421	30976284
40,000	20	17	8	HPR150Ø40H7M02G-HP421	30898813

Configurable features



Bore diameter tolerance IT6/IT7:

- Diameter freely selectable in increments of 0.001 mm
- Can be ordered from tolerance IT6/IT7 depending on the diameter range
- > Ø30.000 IT6 | ≤ Ø30.000 IT7

Specification:

HPR150Ø[diameter][tolerance]M02G-HP421

Bore diameter tolerance < IT6/IT7:

- Tolerances smaller than IT6/IT7 can be ordered as a special tool diameter (G variant, see page 373)

G variant specification:

HPR150GØ[diameter][tolerance]M02G-HP421

Dimensions of configurable series IT6/IT7

d ₁	l ₄	l ₅	HFS size	z	Tolerance
16,600 - 21,290	14	-	10	6	IT7
21,300 - 24,990	15,5	-	12	6	IT7
25,000 - 28,990	15,5	-	14	6	IT7
29,000 - 29,990	17	-	16	6	IT7
30,000 - 36,990	17	-	16	6	IT6
37,000 - 44,990	17	-	20	8	IT6
45,000 - 50,700	19	-	24	8	IT6
50,710 - 65,000	25	-	24	8	IT6

IT6 tolerance example:

HPR150Ø37.350H6M02G-HP421

Bore diameter d₁ = 37.350 H6

G variant example:

HPR150GØ37.350-5M02G-HP421

Special tool diameter d₁ = 37.350 -5 µm

Dimensions in mm.

For associated HFS replaceable head holders, see page 460.

For cutting data recommendations, see end of chapter.

HPR replaceable head reamer

Fixed design, straight fluted, for blind bores
HPR150

Design:

Reamer diameter:
Lead:
Cutting material:

16.600-65.000 mm
MC1G
CP134
Cermet
PVD-coated

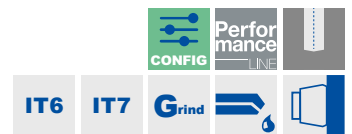
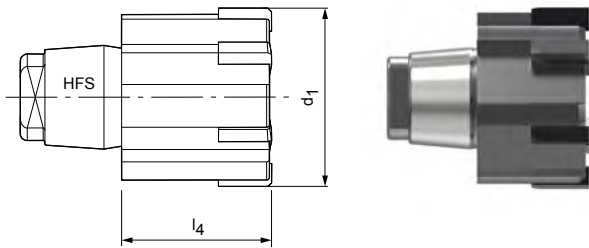

Configurable features



Bore diameter tolerance IT6/IT7:

- Diameter freely selectable in increments of 0.001 mm
- Can be ordered from tolerance IT6/IT7 depending on the diameter range
- > Ø30.000 IT6 | ≤ Ø30.000 IT7

Specification:

HPR150Ø[diameter][tolerance]MC1G-CP134

Bore diameter tolerance < IT6/IT7:

- Tolerances smaller than IT6/IT7 can be ordered as a special tool diameter (G variant, see page 373)

G variant specification:

HPR150GØ[diameter][tolerance]MC1G-CP134

Dimensions of configurable series IT6/IT7

d1	l4	l5	HFS size	z	Tolerance
16,600 - 21,290	14	-	10	6	IT7
21,300 - 24,990	15,5	-	12	6	IT7
25,000 - 28,990	15,5	-	14	6	IT7
29,000 - 29,990	17	-	16	6	IT7
30,000 - 36,990	17	-	16	6	IT6
37,000 - 44,990	17	-	20	8	IT6
45,000 - 50,700	19	-	24	8	IT6
50,710 - 65,000	25	-	24	8	IT6

IT6 tolerance example:

HPR150Ø37.350H6MC1G-CP134

Bore diameter d₁ = 37.350 H6

G variant example:

HPR150GØ37.350-5MC1G-CP134

Special tool diameter d₁ = 37.350 -5 µm

Dimensions in mm.

* for surfaces R_a < 2 µm

For associated HFS replaceable head holders, see page 460.

For cutting data recommendations, see end of chapter.

HPR replaceable head reamer

Fixed design, straight fluted, for blind bores
HPR150

Design:

Reamer diameter: 16.600-65.000 mm
Lead: MC1G
Cutting material: Solid carbide
CVD-coated

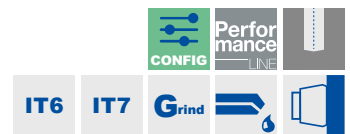
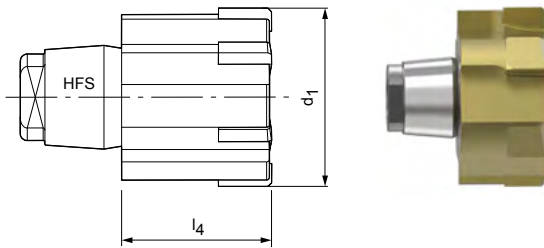

Configurable features



Bore diameter tolerance IT6/IT7:

- Diameter freely selectable in increments of 0.001 mm
- Can be ordered from tolerance IT6/IT7 depending on the diameter range
- > $\emptyset 30.000$ IT6 | $\leq \emptyset 30.000$ IT7

Specification:

HPR150 \emptyset [diameter][tolerance]MC1G-HC419

Bore diameter tolerance < IT6/IT7:

- Tolerances smaller than IT6/IT7 can be ordered as a special tool diameter (G variant, see page 373)

G variant specification:

HPR150G \emptyset [diameter][tolerance]MC1G-HC419

Dimensions of configurable series IT6/IT7

d1	l ₄	l ₅	HFS size	z	Tolerance
16,600 - 21,290	14	-	10	6	IT7
21,300 - 24,990	15,5	-	12	6	IT7
25,000 - 28,990	15,5	-	14	6	IT7
29,000 - 29,990	17	-	16	6	IT7
30,000 - 36,990	17	-	16	6	IT6
37,000 - 44,990	17	-	20	8	IT6
45,000 - 50,700	19	-	24	8	IT6
50,710 - 65,000	25	-	24	8	IT6

IT6 tolerance example:

HPR150 \emptyset 37.350H6MC1G-HC419

Bore diameter $d_1 = 37.350$ H6

G variant example:

HPR150G \emptyset 37.350-7MC1G-HC419

Special tool diameter $d_1 = 37.350 -7 \mu\text{m}$

Dimensions in mm.

* for surfaces $R_a > 2 \mu\text{m}$

For associated HFS replaceable head holders, see page 460.

For cutting data recommendations, see end of chapter.

HPR replaceable head reamer

Fixed design, straight fluted, for blind bores
HPR150

Design:

Reamer diameter: 16.600-65.000 mm
Lead: MC1G
Cutting material: HP421
Carbide
PVD-coated

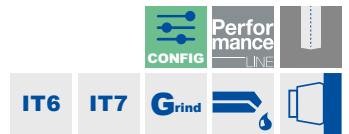
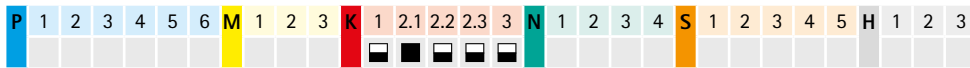
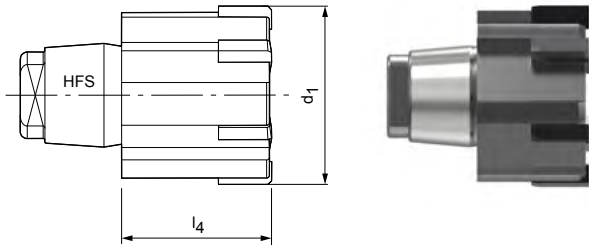

Configurable features



Bore diameter tolerance IT6/IT7:

- Diameter freely selectable in increments of 0.001 mm
- Can be ordered from tolerance IT6/IT7 depending on the diameter range
- > Ø30.000 IT6 | ≤ Ø30.000 IT7

Specification:

HPR150Ø[diameter][tolerance]MC1G-HP421

Bore diameter tolerance < IT6/IT7:

- Tolerances smaller than IT6/IT7 can be ordered as a special tool diameter (G variant, see page 373)

G variant specification:

HPR150GØ[diameter][tolerance]MC1G-HP421

Dimensions of configurable series IT6/IT7

d1	l4	l5	HFS size	z	Tolerance
16,600 - 21,290	14	-	10	6	IT7
21,300 - 24,990	15,5	-	12	6	IT7
25,000 - 28,990	15,5	-	14	6	IT7
29,000 - 29,990	17	-	16	6	IT7
30,000 - 36,990	17	-	16	6	IT6
37,000 - 44,990	17	-	20	8	IT6
45,000 - 50,700	19	-	24	8	IT6
50,710 - 65,000	25	-	24	8	IT6

IT6 tolerance example:

HPR150Ø37.350H6MC1G-HP421

Bore diameter d₁ = 37.350 H6

G variant example:

HPR150GØ37.350-5MC1G-HP421

Special tool diameter d₁ = 37.350 -5 µm

Dimensions in mm.

For associated HFS replaceable head holders, see page 460.

For cutting data recommendations, see end of chapter.

HPR replaceable head reamer

Fixed design, straight fluted, for blind bores
HPR150

Design:

Reamer diameter: 16.600-65.000 mm
Lead: MC1G
Cutting material: HP423
Carbide
PVD-coated

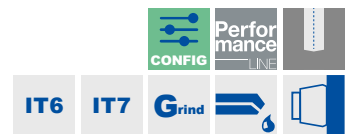
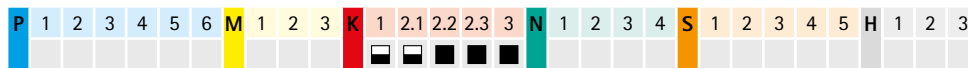
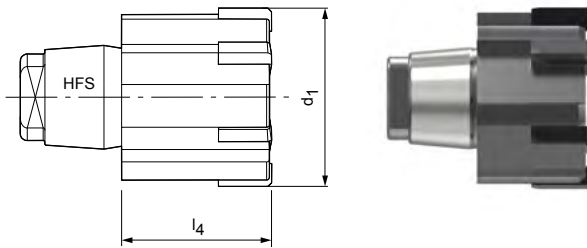

Configurable features



Bore diameter tolerance IT6/IT7:

- Diameter freely selectable in increments of 0.001 mm
- Can be ordered from tolerance IT6/IT7 depending on the diameter range
- > $\varnothing 30.000$ IT6 | $\leq \varnothing 30.000$ IT7

Specification:

HPR150 \varnothing [diameter][tolerance]MC1G-HP423

Bore diameter tolerance < IT6/IT7:

- Tolerances smaller than IT6/IT7 can be ordered as a special tool diameter (G variant, see page 373)

G variant specification:

HPR150G \varnothing [diameter][tolerance]MC1G-HP423

Dimensions of configurable series IT6/IT7

d1	l ₄	l ₅	HFS size	z	Tolerance
16,600 - 21,290	14	-	10	6	IT7
21,300 - 24,990	15,5	-	12	6	IT7
25,000 - 28,990	15,5	-	14	6	IT7
29,000 - 29,990	17	-	16	6	IT7
30,000 - 36,990	17	-	16	6	IT6
37,000 - 44,990	17	-	20	8	IT6
45,000 - 50,700	19	-	24	8	IT6
50,710 - 65,000	25	-	24	8	IT6

IT6 tolerance example:

HPR150 \varnothing 37.350H6MC1G-HP423

Bore diameter $d_1 = 37.350$ H6

G variant example:

HPR150G \varnothing 37.350-8MC1G-HP423

Special tool diameter $d_1 = 37.350 -7 \mu\text{m}$

Dimensions in mm.

For associated HFS replaceable head holders, see page 460.

For cutting data recommendations, see end of chapter.

HPR replaceable head reamer

Fixed design, straight fluted, for blind bores
HPR150

Design:

Reamer diameter: 16.600-65.000 mm
Lead: MA0A
Cutting material: PU620
PCD-tipped

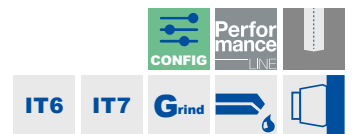
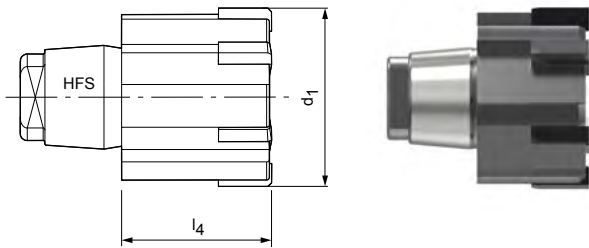

Configurable features



Bore diameter tolerance IT6/IT7:

- Diameter freely selectable in increments of 0.001 mm
- Can be ordered from tolerance IT6/IT7 depending on the diameter range
- > Ø30.000 IT6 | ≤ Ø30.000 IT7

Specification:

HPR150Ø[diameter][tolerance]MA0A-PU620

Bore diameter tolerance < IT6/IT7:

- Tolerances smaller than IT6/IT7 can be ordered as a special tool diameter (G variant, see page 373)

G variant specification:

HPR150GØ[diameter][tolerance]MA0A-PU620

Dimensions of configurable series IT6/IT7

d1	l4	l5	HFS size	z	Tolerance
16,600 - 21,290	14	-	10	6	IT7
21,300 - 24,990	15,5	-	12	6	IT7
25,000 - 28,990	15,5	-	14	6	IT7
29,000 - 29,990	17	-	16	6	IT7
30,000 - 36,990	17	-	16	6	IT6
37,000 - 44,990	17	-	20	8	IT6
45,000 - 50,700	19	-	24	8	IT6
50,710 - 65,000	25	-	24	8	IT6

IT6 tolerance example:

HPR150Ø37.350H6MA0A-PU620

Bore diameter d₁ = 37.350 H6

G variant example:

HPR150GØ37.350-3MA0A-PU620

Special tool diameter d₁ = 37.350 -3 µm

Dimensions in mm.

For associated HFS replaceable head holders, see page 460.

For cutting data recommendations, see end of chapter.

HPR replaceable head reamer

Fixed design, straight fluted, for blind bores
HPR150

Design:

Reamer diameter: 16.600-65.000 mm
Lead: M02G
Cutting material: HP625
Carbide
PVD-coated

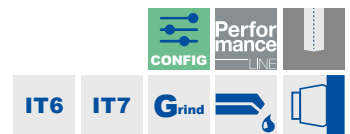
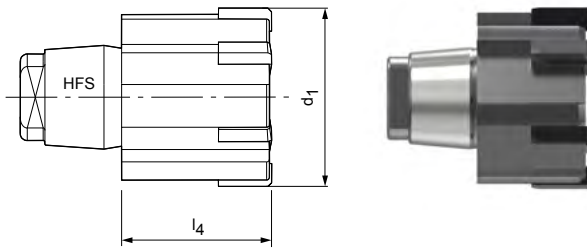

Configurable features



Bore diameter tolerance IT6/IT7:

- Diameter freely selectable in increments of 0.001 mm
- Can be ordered from tolerance IT6/IT7 depending on the diameter range
- > $\emptyset 30.000$ IT6 | $\leq \emptyset 30.000$ IT7

Specification:

HPR150 \emptyset [diameter][tolerance]M02G-HP625

Bore diameter tolerance < IT6/IT7:

- Tolerances smaller than IT6/IT7 can be ordered as a special tool diameter (G variant, see page 373)

G variant specification:

HPR150G \emptyset [diameter][tolerance]M02G-HP625

Dimensions of configurable series IT6/IT7

d1	l ₄	l ₅	HFS size	z	Tolerance
16,600 - 21,290	14	-	10	6	IT7
21,300 - 24,990	15,5	-	12	6	IT7
25,000 - 28,990	15,5	-	14	6	IT7
29,000 - 29,990	17	-	16	6	IT7
30,000 - 36,990	17	-	16	6	IT6
37,000 - 44,990	17	-	20	8	IT6
45,000 - 50,700	19	-	24	8	IT6
50,710 - 65,000	25	-	24	8	IT6

IT6 tolerance example:

HPR150 \emptyset 37.350H6M02G-HP625

Bore diameter $d_1 = 37.350$ H6

G variant example:

HPR150G \emptyset 37.350-7M02G-HP625

Special tool diameter $d_1 = 37.350 -5 \mu\text{m}$

Dimensions in mm.

For associated HFS replaceable head holders, see page 460.

For cutting data recommendations, see end of chapter.

HPR replaceable head reamer

Finely adjustable design, straight fluted, for through bores
HPR230

Design:

Reamer diameter:
Lead:
Cutting material:

7.000-18.590 mm
MC1G
CP134
Cermet
PVD-coated

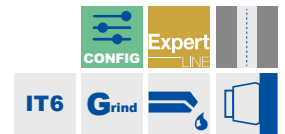
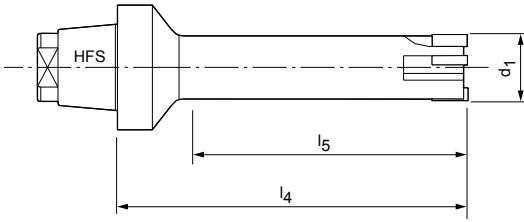

Configurable features



Bore diameter tolerance IT6:

- Diameter freely selectable in increments of 0.001 mm
- Can be ordered in tolerance IT6

Specification:

HPR230Ø[diameter][tolerance]MC1G-CP134

Bore diameter tolerance < IT6:

- Tolerances smaller than IT6 can be ordered as a special tool diameter (G variant, see page 373)

G variant specification:

HPR230GØ[diameter][tolerance]MC1G-CP134

Dimensions of configurable series IT6

d ₁	l ₄	l ₅	HFS size	z
7,000 - 9,590	60	45	12	4
9,600 - 18,590	60	45	12	6

IT6 tolerance example:

HPR230Ø10.350H6MC1G-CP134

Bore diameter d₁ = 10.350 H6

G variant example:

HPR230GØ10.350+1-1MC1G-CP134

Special tool diameter d₁ = 10.350 +1 µm -1 µm

Dimensions in mm.

* for surfaces R_a < 2 µm

For associated HFS replaceable head holders, see page 460.

For cutting data recommendations, see end of chapter.

HPR replaceable head reamer

Finely adjustable design, straight fluted, for through bores
HPR230

Design:

Reamer diameter: 7.000-18.590 mm
Lead: MC1G
Cutting material: HP421
Carbide
PVD-coated

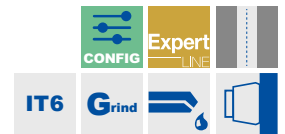
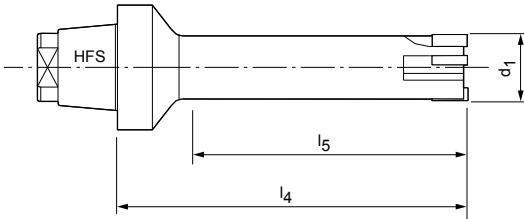

Configurable features



Bore diameter tolerance IT6:

- Diameter freely selectable in increments of 0.001 mm
- Can be ordered in tolerance IT6

Specification:

HPR230Ø[diameter][tolerance]MC1G-HP421

Bore diameter tolerance < IT6:

- Tolerances smaller than IT6 can be ordered as a special tool diameter (G variant, see page 373)

G variant specification:

HPR230GØ[diameter][tolerance]MC1G-HP421

Dimensions of configurable series IT6

d ₁	l ₄	l ₅	HFS size	z
7,000 - 9,590	60	45	12	4
9,600 - 18,590	60	45	12	6

IT6 tolerance example:

HPR230Ø10.350H6MC1G-HP421

Bore diameter d₁ = 10.350 H6

G variant example:

HPR230GØ10.350+1-1MC1G-HP421

Special tool diameter d₁ = 10.350 +1 µm -1 µm

Dimensions in mm.

For associated HFS replaceable head holders, see page 460.

For cutting data recommendations, see end of chapter.

HPR replaceable head reamer

Finely adjustable design, straight fluted, for through bores
HPR230

Design:

Reamer diameter:
Lead:
Cutting material:

7.000-18.590 mm
MC1G
HP423
Carbide
PVD-coated

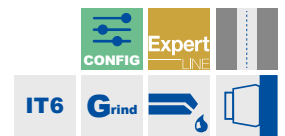
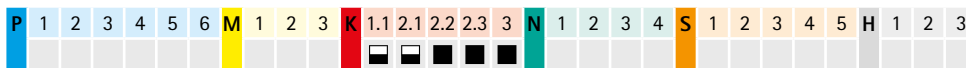
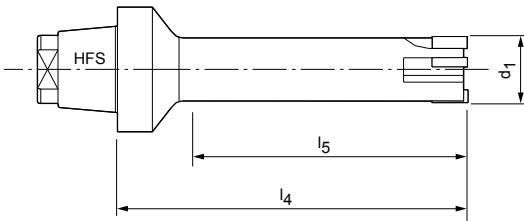

Configurable features



Bore diameter tolerance IT6:

- Diameter freely selectable in increments of 0.001 mm
- Can be ordered in tolerance IT6

Specification:

HPR230Ø[diameter][tolerance]MC1G-HP423

Bore diameter tolerance < IT6:

- Tolerances smaller than IT6 can be ordered as a special tool diameter (G variant, see page 373)

G variant specification:

HPR230GØ[diameter][tolerance]MC1G-HP423

Dimensions of configurable series IT6

d ₁	l ₄	l ₅	HFS size	z
7,000 - 9,590	60	45	12	4
9,600 - 18,590	60	45	12	6

IT6 tolerance example:

HPR230Ø10.350H6MC1G-HP423

Bore diameter d₁ = 10.350 H6

G variant example:

HPR230GØ10.350+1-1MC1G-HP423

Special tool diameter d₁ = 10.350 +1 µm -1 µm

Dimensions in mm.

For associated HFS replaceable head holders, see page 460.

For cutting data recommendations, see end of chapter.

HPR replaceable head reamer

Finely adjustable design, straight fluted, for through bores
HPR230

Design:

Reamer diameter:
Lead:
Cutting material:

7.000-18.590 mm
MA0A
PU620
PCD-tipped

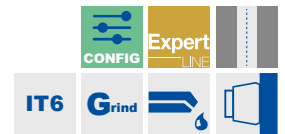
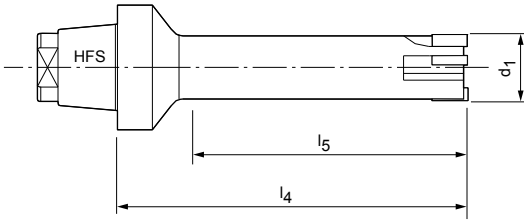

Configurable features



Bore diameter tolerance IT6:

- Diameter freely selectable in increments of 0.001 mm
- Can be ordered in tolerance IT6

Specification:

HPR230Ø[diameter][tolerance]MA0A-PU620

Bore diameter tolerance < IT6:

- Tolerances smaller than IT6 can be ordered as a special tool diameter (G variant, see page 373)

G variant specification:

HPR230GØ[diameter][tolerance]MA0A-PU620

Dimensions of configurable series IT6

d ₁	l ₄	l ₅	HFS size	z
7,000 - 9,590	60	45	12	4
9,600 - 18,590	60	45	12	6

IT6 tolerance example:

HPR230Ø10.350H6MA0A-PU620

Bore diameter d₁ = 10.350 H6

G variant example:

HPR230GØ10.350+1-1MA0A-PU620

Special tool diameter d₁ = 10.350 +1 µm -1 µm

Dimensions in mm.

For associated HFS replaceable head holders, see page 460.

For cutting data recommendations, see end of chapter.

HPR replaceable head reamer

Finely adjustable design, left-hand fluted, for through bores
HPR231

Design:

Reamer diameter:
Lead:
Cutting material:

7.000-18.590 mm
ME1G
CU134
Uncoated cermet

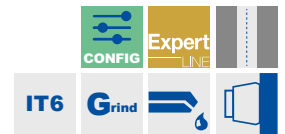
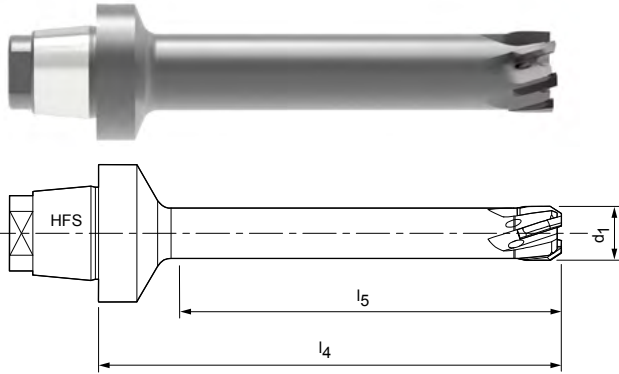

Configurable features



Bore diameter tolerance IT6:
- Diameter freely selectable in increments of 0.001 mm
- Can be ordered in tolerance IT6

Specification:
HPR231Ø[diameter][tolerance]ME1G-CU134

Bore diameter tolerance < IT6:
- Tolerances smaller than IT6 can be ordered as a special tool diameter (G variant, see page 373)

G variant specification:
HPR231GØ[diameter][tolerance]ME1G-CU134

Dimensions of configurable series IT6

d ₁	l ₄	l ₅	HFS size	z
7,000 - 9,590	60	45	12	4
9,600 - 18,590	60	45	12	6

IT6 tolerance example:
HPR231Ø10.350H6ME1G-CU134

Bore diameter d₁ = 10.350 H6

G variant example:
HPR231GØ10.350+1-1ME1G-CU134

Special tool diameter d₁ = 10.350 +1 µm -1 µm

Dimensions in mm.
For associated HFS replaceable head holders, see page 460.
For cutting data recommendations, see end of chapter.

HPR replaceable head reamer

Finely adjustable design, left-hand fluted, for through bores
HPR231

Design:

Reamer diameter: 7.000-18.590 mm
Lead: ME1G
Cutting material: HP421
Carbide
PVD-coated

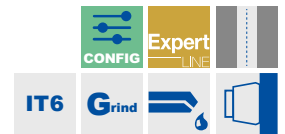
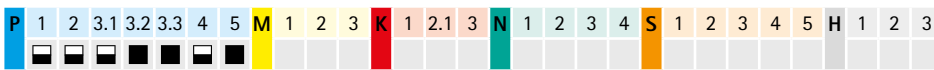
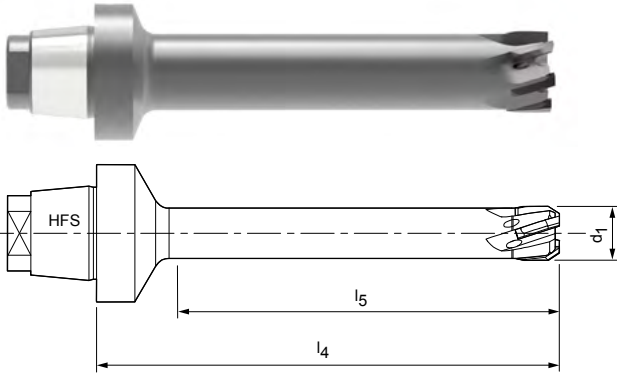

Configurable features



Bore diameter tolerance IT6:
- Diameter freely selectable in increments of 0.001 mm
- Can be ordered in tolerance IT6

Specification:
HPR231Ø[diameter][tolerance]ME1G-HP421

Bore diameter tolerance < IT6:
- Tolerances smaller than IT6 can be ordered as a special tool diameter (G variant, see page 373)

G variant specification:
HPR231GØ[diameter][tolerance]ME1G-HP421

Dimensions of configurable series IT6

d ₁	l ₄	l ₅	HFS size	z
7,000 - 9,590	60	45	12	4
9,600 - 18,590	60	45	12	6

IT6 tolerance example:
HPR231Ø10.350H6ME1G-HP421

Bore diameter d₁ = 10.350 H6

G variant example:
HPR231GØ10.350+1-1ME1G-HP421

Special tool diameter d₁ = 10.350 +1 µm -1 µm

Dimensions in mm.
For associated HFS replaceable head holders, see page 460.
For cutting data recommendations, see end of chapter.

HPR replaceable head reamer

Finely adjustable design, left-hand fluted, for through bores
HPR231

Design:

Reamer diameter:
Lead:
Cutting material:

7.000-18.590 mm
MF1G
HP421
Carbide
PVD-coated

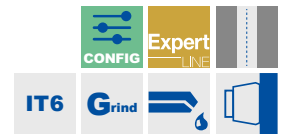
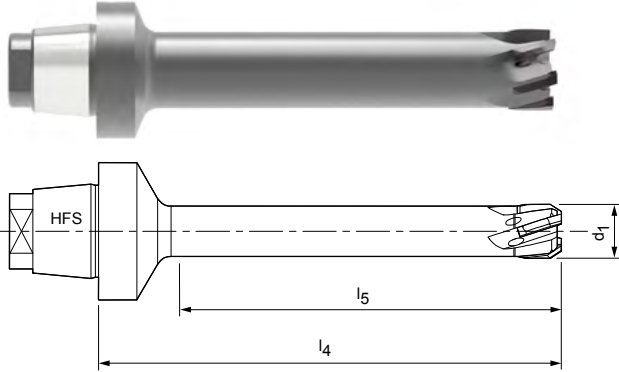

Configurable features



Bore diameter tolerance IT6:
- Diameter freely selectable in increments of 0.001 mm
- Can be ordered in tolerance IT6

Specification:
HPR231Ø[diameter][tolerance]MF1G-HP421

Bore diameter tolerance < IT6:
- Tolerances smaller than IT6 can be ordered as a special tool diameter (G variant, see page 373)

G variant specification:
HPR231GØ[diameter][tolerance]MF1G-HP421

Dimensions of configurable series IT6

d ₁	l ₄	l ₅	HFS size	z
7,000 - 9,590	60	45	12	4
9,600 - 18,590	60	45	12	6

IT6 tolerance example:
HPR231Ø10.350H6MF1G-HP421

Bore diameter d₁ = 10.350 H6

G variant example:
HPR231GØ10.350+1-1MF1G-HP421

Special tool diameter d₁ = 10.350 +1 µm -1 µm

Dimensions in mm.
For associated HFS replaceable head holders, see page 460.
For cutting data recommendations, see end of chapter.

HPR replaceable head reamer

Finely adjustable design, left-hand fluted, for through bores
HPR231

Design:

Reamer diameter:

7.000–18.590 mm

Lead:

MF1G

Cutting material:

HP625

Carbide

PVD-coated

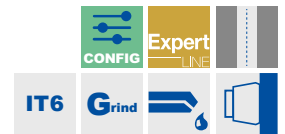
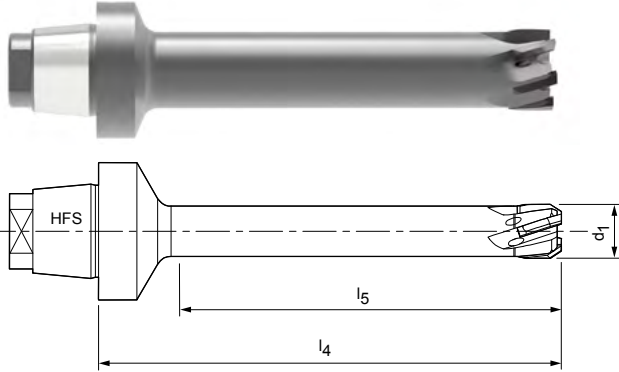

Configurable features

Bore diameter tolerance IT6:

- Diameter freely selectable in increments of 0.001 mm
- Can be ordered in tolerance IT6

Specification:

HPR231Ø[diameter][tolerance]MF1G-HP625

Bore diameter tolerance < IT6:

- Tolerances smaller than IT6 can be ordered as a special tool diameter (G variant, see page 373)

G variant specification:

HPR231GØ[diameter][tolerance]MF1G-HP625

Dimensions of configurable series IT6

d_1	l_4	l_5	HFS size	z
7,000 - 9,590	60	45	12	4
9,600 - 18,590	60	45	12	6

IT6 tolerance example:

HPR231Ø10.350H6MF1G-HP625

Bore diameter $d_1 = 10.350 \text{ H6}$

G variant example:

HPR231GØ10.350+1-1MF1G-HP625

Special tool diameter $d_1 = 10.350 +1 \mu\text{m} -1 \mu\text{m}$

Dimensions in mm.

For associated HFS replaceable head holders, see page 460.

For cutting data recommendations, see end of chapter.

HPR replaceable head reamer

Finely adjustable design, straight fluted, for through bores
HPR200

Design:

Reamer diameter:
Lead:
Cutting material:

18.600-65.000 mm
MC1G
CP134
Cermet
PVD-coated

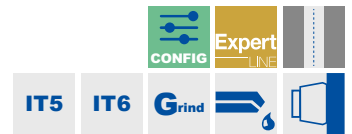
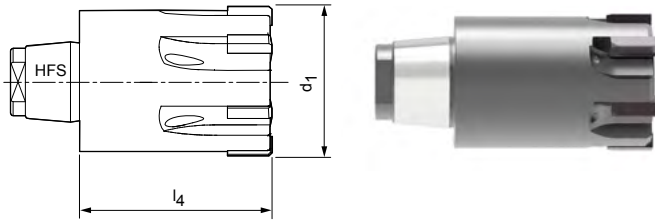

Configurable features



Bore diameter tolerance IT5/IT6:

- Diameter freely selectable in increments of 0.001 mm
- Depending on the diameter range can be ordered from tolerance IT5/IT6
- > 030.000 IT5 | ≤ 030.000 IT6

Specification:

HPR200Ø[diameter][tolerance]MC1G-CP134

Bore diameter tolerance < IT5/IT6:

- Tolerances smaller than IT5/IT6 can be ordered as a special tool diameter (G variant, see page 373)

G variant specification:

HPR200GØ[diameter][tolerance]MC1G-CP134

Dimensions of configurable series IT5/IT6

d ₁	l ₄	l ₅	HFS size	z	Tolerance
18,600 - 20,390	25	-	12	6	IT6
20,400 - 21,290	27	-	12	6	IT6
21,300 - 23,990	27	-	14	6	IT6
24,000 - 29,990	35	-	16	6	IT6
30,000 - 39,990	41	-	20	8	IT5
40,000 - 65,000	47	-	24	8	IT5

IT5 tolerance example:

HPR200Ø35.350H5MC1G-CP134

Bore diameter d₁ = 35.350 H5

G variant example:

HPR200GØ35.350+1-1MC1G-CP134

Special tool diameter d₁ = 35.350 +1 µm -1 µm

Dimensions in mm.

* for surfaces R_a < 2 µm

For associated HFS replaceable head holders, see page 460.

For cutting data recommendations, see end of chapter.

HPR replaceable head reamer

Finely adjustable design, straight fluted, for through bores
HPR200

Design:

Reamer diameter: 18.600-65.000 mm
Lead: MC1G
Cutting material: HP421
Carbide
PVD-coated

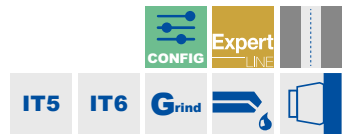
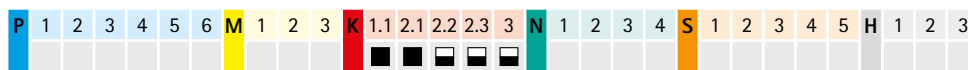
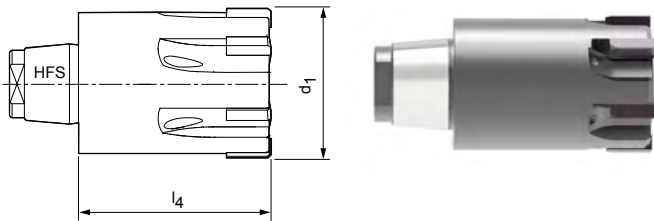

Configurable features

Bore diameter tolerance IT5/IT6:

- Diameter freely selectable in increments of 0.001 mm
- Depending on the diameter range can be ordered from tolerance IT5/IT6
- > 030.000 IT5 | ≤ 030.000 IT6

Specification:

HPR200Ø[diameter][tolerance]MC1G-HP421

Bore diameter tolerance < IT5/IT6:

- Tolerances smaller than IT5/IT6 can be ordered as a special tool diameter (G variant, see page 373)

G variant specification:

HPR200GØ[diameter][tolerance]MC1G-HP421

Dimensions of configurable series IT5/IT6

d_1	l_4	l_5	HFS size	z	Tolerance
18,600 - 20,390	25	-	12	6	IT6
20,400 - 21,290	27	-	12	6	IT6
21,300 - 23,990	27	-	14	6	IT6
24,000 - 29,990	35	-	16	6	IT6
30,000 - 39,990	41	-	20	8	IT5
40,000 - 65,000	47	-	24	8	IT5

IT5 tolerance example:

HPR200Ø35.350H5MC1G-HP421

Bore diameter $d_1 = 35.350 \text{ H5}$

G variant example:

HPR200GØ35.350+1-1MC1G-HP421

Special tool diameter $d_1 = 35.350 +1 \mu\text{m} -1 \mu\text{m}$

Dimensions in mm.

For associated HFS replaceable head holders, see page 460.

For cutting data recommendations, see end of chapter.

HPR replaceable head reamer

Finely adjustable design, straight fluted, for through bores
HPR200

Design:

Reamer diameter:
Lead:
Cutting material:

18.600-65.000 mm
MC1G
HP423
Carbide
PVD-coated

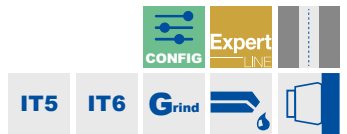
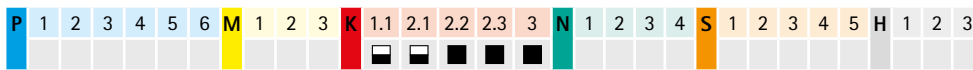
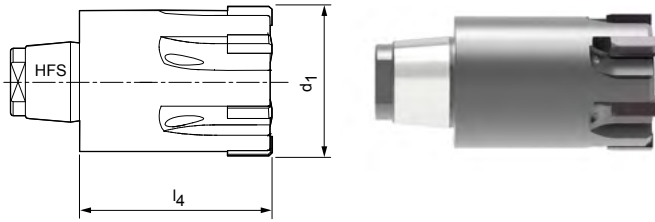

Configurable features



Bore diameter tolerance IT5/IT6:
- Diameter freely selectable in increments of 0.001 mm
- Depending on the diameter range can be ordered from tolerance IT5/IT6
- > Ø30.000 IT5 | ≤ Ø30.000 IT6

Specification:
HPR200Ø[diameter][tolerance]MC1G-HP423

Bore diameter tolerance < IT5/IT6:
- Tolerances smaller than IT5/IT6 can be ordered as a special tool diameter (G variant, see page 373)

G variant specification:
HPR200GØ[diameter][tolerance]MC1G-HP423

Dimensions of configurable series IT5/IT6

d ₁	l ₄	l ₅	HFS size	z	Tolerance
18,600 - 20,390	25	-	12	6	IT6
20,400 - 21,290	27	-	12	6	IT6
21,300 - 23,990	27	-	14	6	IT6
24,000 - 29,990	35	-	16	6	IT6
30,000 - 39,990	41	-	20	8	IT5
40,000 - 65,000	47	-	24	8	IT5

IT5 tolerance example:
HPR200Ø35.350H5MC1G-HP423

Bore diameter d₁ = 35.350 H5

G variant example:
HPR200GØ35.350+1-1MC1G-HP423

Special tool diameter d₁ = 35.350 +1 µm -1 µm

Dimensions in mm.
For associated HFS replaceable head holders, see page 460.
For cutting data recommendations, see end of chapter.

HPR replaceable head reamer

Finely adjustable design, straight fluted, for through bores
HPR200

Design:

Reamer diameter: 18.600-65.000 mm
Lead: MA0A
Cutting material: PU620
PCD-tipped

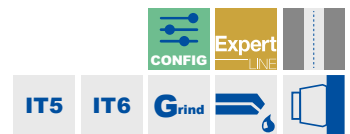
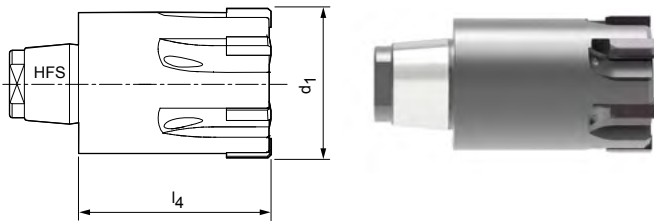

Configurable features

Bore diameter tolerance IT5/IT6:

- Diameter freely selectable in increments of 0.001 mm
- Can be ordered from tolerance IT5/IT6 depending on the diameter range
- > 030.000 IT5 | ≤ 030.000 IT6

Specification:

HPR200Ø[diameter][tolerance]MA0A-PU620

Bore diameter tolerance < IT5/IT6:

- Tolerances smaller than IT5/IT6 can be ordered as a special tool diameter (G variant, see page 373)

G variant specification:

HPR200GØ[diameter][tolerance]MA0A-PU620

Dimensions of configurable series IT5/IT6

d ₁	l ₄	l ₅	HFS size	z	Tolerance
18,600 - 20,390	25	-	12	6	IT6
20,400 - 21,290	27	-	12	6	IT6
21,300 - 23,990	27	-	14	6	IT6
24,000 - 29,990	35	-	16	6	IT6
30,000 - 39,990	41	-	20	8	IT5
40,000 - 65,000	47	-	24	8	IT5

IT5 tolerance example:

HPR200Ø35.350H5MA0A-PU620

Bore diameter d₁ = 35.350 H5

G variant example:

HPR200GØ35.350+1-1MA0A-PU620

Special tool diameter d₁ = 35.350 +1 µm -1 µm

Dimensions in mm.

For associated HFS replaceable head holders, see page 460.

For cutting data recommendations, see end of chapter.

HPR replaceable head reamer

Finely adjustable design, left-hand fluted, for through bores
HPR210

Design:

Reamer diameter:
Lead:
Cutting material:

18.600-65.000 mm
ME1G
CU134
Uncoated cermet

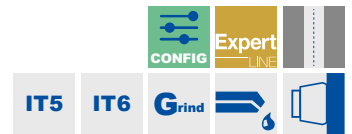
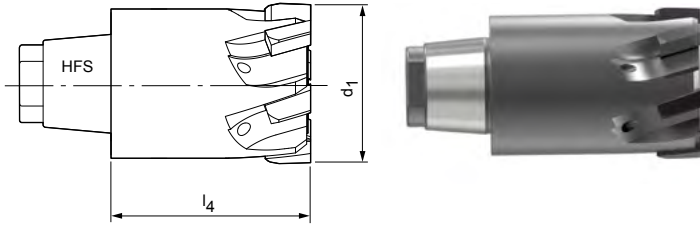

Configurable features



Bore diameter tolerance IT5/IT6:

- Diameter freely selectable in increments of 0.001 mm
- Can be ordered from tolerance IT5/IT6 depending on the diameter range
- > Ø30.000 IT5 | ≤ Ø30.000 IT6

Specification:

HPR210Ø[diameter][tolerance]ME1G-CU134

Bore diameter tolerance < IT5/IT6:

- Tolerances smaller than IT5/IT6 can be ordered as a special tool diameter (G variant, see page 373)

G variant specification:

HPR210GØ[diameter][tolerance]ME1G-CU134

Dimensions of configurable series IT5/IT6

d ₁	l ₄	l ₅	HFS size	z	Tolerance
18,600 - 20,390	25	-	12	6	IT6
20,400 - 21,290	27	-	12	6	IT6
21,300 - 23,990	27	-	14	6	IT6
24,000 - 29,990	35	-	16	6	IT6
30,000 - 39,990	41	-	20	8	IT5
40,000 - 65,000	47	-	24	8	IT5

IT5 tolerance example:

HPR210Ø35.350H5ME1G-CU134

Bore diameter d₁ = 35.350 H5

G variant example:

HPR210GØ35.350+1-1ME1G-CU134

Special tool diameter d₁ = 35.350 +1 µm -1 µm

Dimensions in mm.

For associated HFS replaceable head holders, see page 460.

For cutting data recommendations, see end of chapter.

HPR replaceable head reamer

Finely adjustable design, left-hand fluted, for through bores
HPR210

Design:

Reamer diameter: 18.600-65.000 mm
Lead: ME1G
Cutting material: HP421
Carbide
PVD-coated

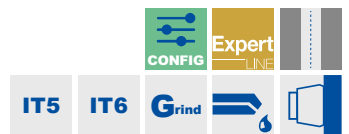
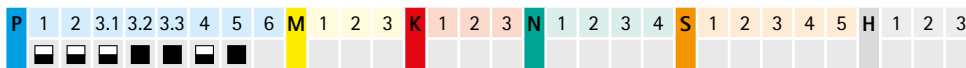
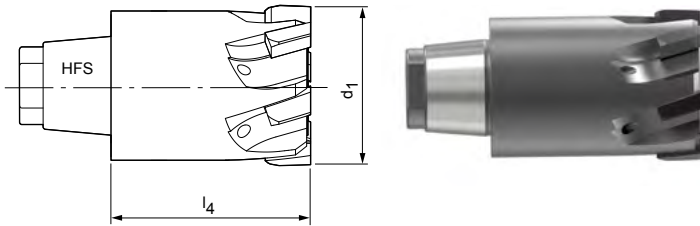

Configurable features

Bore diameter tolerance IT5/IT6:

- Diameter freely selectable in increments of 0.001 mm
- Can be ordered from tolerance IT5/IT6 depending on the diameter range
- > Ø30.000 IT5 | ≤ Ø30.000 IT6

Specification:

HPR210Ø[diameter][tolerance]ME1G-HP421

Bore diameter tolerance < IT5/IT6:

- Tolerances smaller than IT5/IT6 can be ordered as a special tool diameter (G variant, see page 373)

G variant specification:

HPR210GØ[diameter][tolerance]ME1G-HP421

Dimensions of configurable series IT5/IT6

d ₁	l ₄	l ₅	HFS size	z	Tolerance
18,600 - 20,390	25	-	12	6	IT6
20,400 - 21,290	27	-	12	6	IT6
21,300 - 23,990	27	-	14	6	IT6
24,000 - 29,990	35	-	16	6	IT6
30,000 - 39,990	41	-	20	8	IT5
40,000 - 65,000	47	-	24	8	IT5

IT5 tolerance example:

HPR210Ø35.350H5ME1G-HP421

Bore diameter d₁ = 35.350 H5

G variant example:

HPR210GØ35.350+1-1ME1G-HP421

Special tool diameter d₁ = 35.350 +1 µm -1 µm

Dimensions in mm.

For associated HFS replaceable head holders, see page 460.

For cutting data recommendations, see end of chapter.

HPR replaceable head reamer

Finely adjustable design, left-hand fluted, for through bores
HPR210

Design:

Reamer diameter:
Lead:
Cutting material:

18.600-65.000 mm
MF1G
HP421
Carbide
PVD-coated

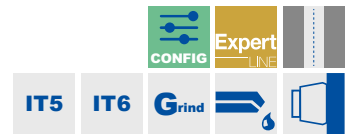
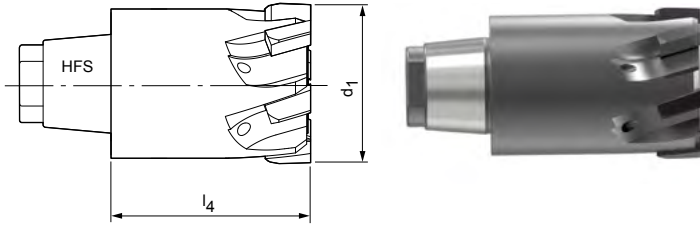

Configurable features



Bore diameter tolerance IT5/IT6:

- Diameter freely selectable in increments of 0.001 mm
- Can be ordered from tolerance IT5/IT6 depending on the diameter range
- > Ø30.000 IT5 | ≤ Ø30.000 IT6

Specification:

HPR210Ø[diameter][tolerance]MF1G-HP421

Bore diameter tolerance < IT5/IT6:

- Tolerances smaller than IT5/IT6 can be ordered as a special tool diameter (G variant, see page 373)

G variant specification:

HPR210GØ[diameter][tolerance]MF1G-HP421

Dimensions of configurable series IT5/IT6

d ₁	l ₄	l ₅	HFS size	z	Tolerance
18,600 - 20,390	25	-	12	6	IT6
20,400 - 21,290	27	-	12	6	IT6
21,300 - 23,990	27	-	14	6	IT6
24,000 - 29,990	35	-	16	6	IT6
30,000 - 39,990	41	-	20	8	IT5
40,000 - 65,000	47	-	24	8	IT5

IT5 tolerance example:

HPR210Ø35.350H5MF1G-HP421

Bore diameter d₁ = 35.350 H5

G variant example:

HPR210GØ35.350+1-1MF1G-HP421

Special tool diameter d₁ = 35.350 +1 µm -1 µm

Dimensions in mm.

For associated HFS replaceable head holders, see page 460.

For cutting data recommendations, see end of chapter.

HPR replaceable head reamer

Finely adjustable design, left-hand fluted, for through bores
HPR210

Design:
Reamer diameter: 18.600-65.000 mm
Lead: MF1G
Cutting material: HP625
Carbide
PVD-coated

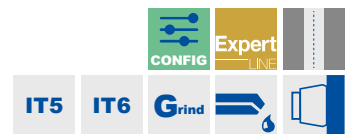
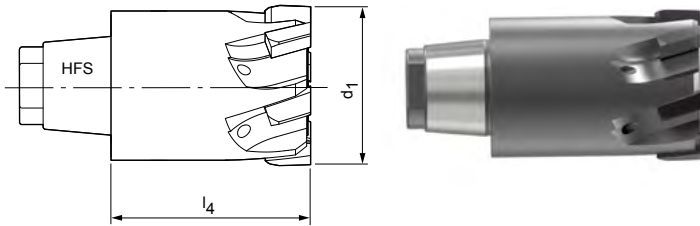

Configurable features



Bore diameter tolerance IT5/IT6:

- Diameter freely selectable in increments of 0.001 mm
- Can be ordered from tolerance IT5/IT6 depending on the diameter range
- > Ø30.000 IT5 | ≤ Ø30.000 IT6

Specification:

HPR210Ø[diameter][tolerance]MF1G-HP625

Bore diameter tolerance < IT5/IT6:

- Tolerances smaller than IT5/IT6 can be ordered as a special tool diameter (G variant, see page 373)

G variant specification:

HPR210GØ[diameter][tolerance]MF1G-HP625

Dimensions of configurable series IT5/IT6

d ₁	l ₄	l ₅	HFS size	z	Tolerance
18,600 - 20,390	25	-	12	6	IT6
20,400 - 21,290	27	-	12	6	IT6
21,300 - 23,990	27	-	14	6	IT6
24,000 - 29,990	35	-	16	6	IT6
30,000 - 39,990	41	-	20	8	IT5
40,000 - 65,000	47	-	24	8	IT5

IT5 tolerance example:

HPR210Ø35.350H5MF1G-HP625

Bore diameter d₁ = 35.350 H5

G variant example:

HPR210GØ35.350+1-1MF1G-HP625

Special tool diameter d₁ = 35.350 +1 µm -1 µm

Dimensions in mm.

For associated HFS replaceable head holders, see page 460.

For cutting data recommendations, see end of chapter.

HPR replaceable head reamer

Finely adjustable design, straight fluted, for blind bores
HPR280

Design:

Reamer diameter:
Lead:
Cutting material:

7.000–21.290 mm
ML2G
CU134
Uncoated cermet

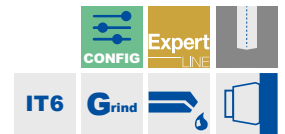
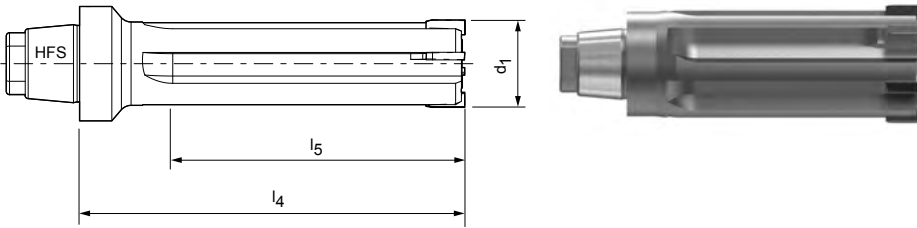

Configurable features



Bore diameter tolerance IT6:
- Diameter freely selectable in increments of 0.001 mm
- Can be ordered in tolerance IT6

Specification:
HPR280Ø[diameter][tolerance]ML2G-CU134

Bore diameter tolerance < IT6:
- Tolerances smaller than IT6 can be ordered as a special tool diameter (G variant, see page 373)

G variant specification:
HPR280GØ[diameter][tolerance]ML2G-CU134

Dimensions of configurable series IT6

d ₁	l ₄	l ₅	HFS size	z
7,000 - 14,590	60	40	12	4
14,600 - 21,290	60	40	12	6

IT6 tolerance example:
HPR280Ø16.350H6ML2G-CU134

Bore diameter d₁ = 16.350 H6

G variant example:
HPR280GØ16.350+1-1ML2G-CU134

Special tool diameter d₁ = 16.350 +1 µm -1 µm

Dimensions in mm.
For associated HFS replaceable head holders, see page 460.
For cutting data recommendations, see end of chapter.

HPR replaceable head reamer

Finely adjustable design, straight fluted, for blind bores
HPR280

Design:

Reamer diameter:

7.000–21.290 mm

Lead:

ML2G

Cutting material:

HP421

Carbide

PVD-coated

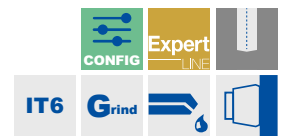
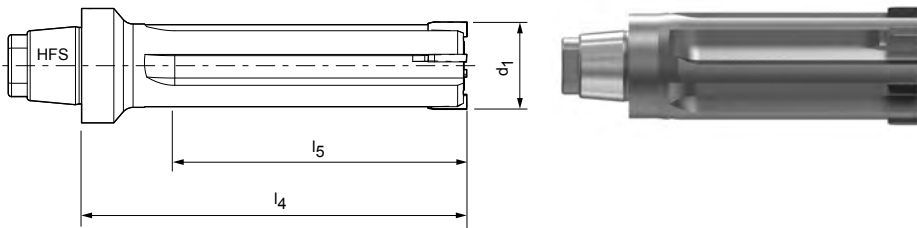

Configurable features

Bore diameter tolerance IT6:

- Diameter freely selectable in increments of 0.001 mm
- Can be ordered in tolerance IT6

Specification:

HPR280Ø[diameter][tolerance]ML2G-HP421

Bore diameter tolerance < IT6:

- Tolerances smaller than IT6 can be ordered as a special tool diameter (G variant, see page 373)

G variant specification:

HPR280GØ[diameter][tolerance]ML2G-HP421

Dimensions of configurable series IT6

d_1	l_4	l_5	HFS size	z
7,000 - 14,590	60	40	12	4
14,600 - 21,290	60	40	12	6

IT6 tolerance example:

HPR280Ø16.350H6ML2G-HP421

Bore diameter $d_1 = 16.350 \text{ H6}$

G variant example:

HPR280GØ16.350+1-1ML2G-HP421

Special tool diameter $d_1 = 16.350 +1 \mu\text{m} -1 \mu\text{m}$

Dimensions in mm.

For associated HFS replaceable head holders, see page 460.

For cutting data recommendations, see end of chapter.

HPR replaceable head reamer

Finely adjustable design, straight fluted, for blind bores
HPR280

Design:

Reamer diameter:
Lead:
Cutting material:

7.000–21.290 mm
M02G
HP421
Carbide
PVD-coated

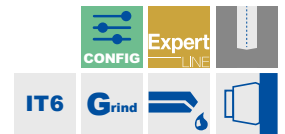
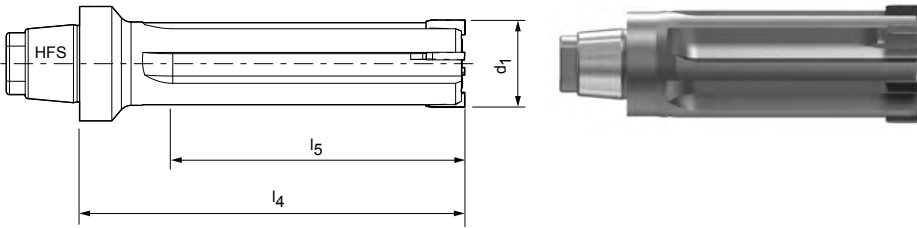

Configurable features



Bore diameter tolerance IT6:

- Diameter freely selectable in increments of 0.001 mm
- Can be ordered in tolerance IT6

Specification:

HPR280Ø[diameter][tolerance]M02G-HP421

Bore diameter tolerance < IT6:

- Tolerances smaller than IT6 can be ordered as a special tool diameter (G variant, see page 373)

G variant specification:

HPR280GØ[diameter][tolerance]M02G-HP421

Dimensions of configurable series IT6

d ₁	l ₄	l ₅	HFS size	z
7,000 - 14,590	60	40	12	4
14,600 - 21,290	60	40	12	6

IT6 tolerance example:

HPR280Ø16.350H6M02G-HP421

Bore diameter d₁ = 16.350 H6

G variant example:

HPR280GØ16.350+1-1M02G-HP421

Special tool diameter d₁ = 16.350 +1 µm -1 µm

Dimensions in mm.

For associated HFS replaceable head holders, see page 460.

For cutting data recommendations, see end of chapter.

HPR replaceable head reamer

Finely adjustable design, straight fluted, for blind bores
HPR280

Design:

Reamer diameter: 7.000–21.290 mm
Lead: MC1G
Cutting material: CP134
Cermet
PVD-coated

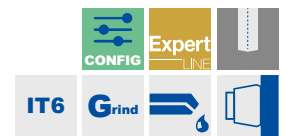
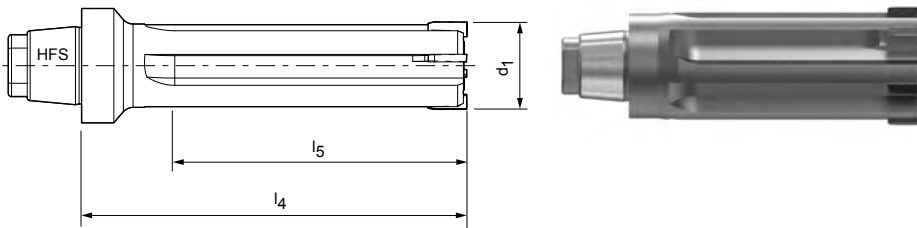

Configurable features



Bore diameter tolerance IT6:

- Diameter freely selectable in increments of 0.001 mm
- Can be ordered in tolerance IT6

Specification:

HPR280Ø[diameter][tolerance]MC1G-CP134

Bore diameter tolerance < IT6:

- Tolerances smaller than IT6 can be ordered as a special tool diameter (G variant, see page 373)

G variant specification:

HPR280GØ[diameter][tolerance]MC1G-CP134

Dimensions of configurable series IT6

d ₁	l ₄	l ₅	HFS size	z
7,000 - 14,590	60	40	12	4
14,600 - 21,290	60	40	12	6

IT6 tolerance example:

HPR280Ø16.350H6MC1G-CP134

Bore diameter d₁ = 16.350 H6

G variant example:

HPR280GØ16.350+1-1MC1G-CP134

Special tool diameter d₁ = 16.350 +1 µm -1 µm

Dimensions in mm.

* for surfaces R_a < 2 µm

For associated HFS replaceable head holders, see page 460.

For cutting data recommendations, see end of chapter.

HPR replaceable head reamer

Finely adjustable design, straight fluted, for blind bores
HPR280

Design:

Reamer diameter:
Lead:
Cutting material:

7.000–21.290 mm
MC1G
HP421
Carbide
PVD-coated

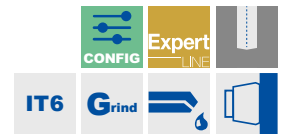
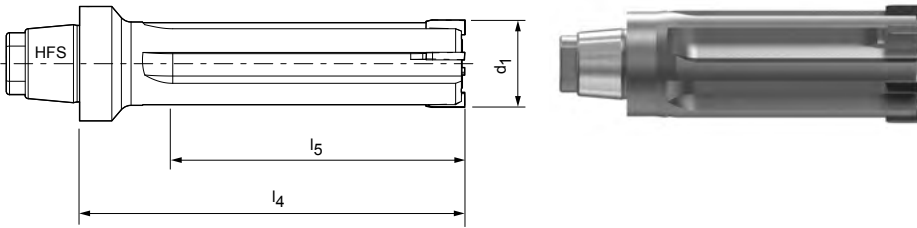

Configurable features



Bore diameter tolerance IT6:

- Diameter freely selectable in increments of 0.001 mm
- Can be ordered in tolerance IT6

Specification:

HPR280Ø[diameter][tolerance]MC1G-HP421

Bore diameter tolerance < IT6:

- Tolerances smaller than IT6 can be ordered as a special tool diameter (G variant, see page 373)

G variant specification:

HPR280GØ[diameter][tolerance]MC1G-HP421

Dimensions of configurable series IT6

d ₁	l ₄	l ₅	HFS size	z
7,000 - 14,590	60	40	12	4
14,600 - 21,290	60	40	12	6

IT6 tolerance example:

HPR280Ø16.350H6MC1G-HP421

Bore diameter d₁ = 16.350 H6

G variant example:

HPR280GØ16.350+1-1MC1G-HP421

Special tool diameter d₁ = 16.350 +1 µm -1 µm

Dimensions in mm.

For associated HFS replaceable head holders, see page 460.

For cutting data recommendations, see end of chapter.

HPR replaceable head reamer

Finely adjustable design, straight fluted, for blind bores
HPR280

Design:

Reamer diameter: 7.000–21.290 mm
Lead: MC1G
Cutting material: HP423
Carbide
PVD-coated

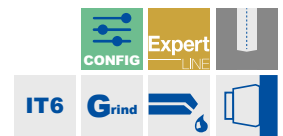
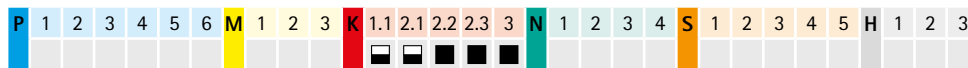
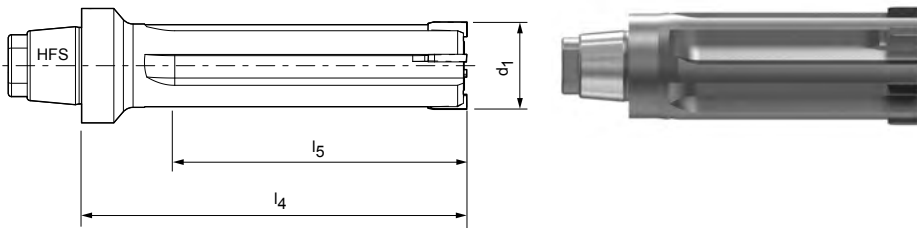

Configurable features



Bore diameter tolerance IT6:

- Diameter freely selectable in increments of 0.001 mm
- Can be ordered in tolerance IT6

Specification:

HPR280Ø[diameter][tolerance]MC1G-HP423

Bore diameter tolerance < IT6:

- Tolerances smaller than IT6 can be ordered as a special tool diameter (G variant, see page 373)

G variant specification:

HPR280GØ[diameter][tolerance]MC1G-HP423

Dimensions of configurable series IT6

d ₁	l ₄	l ₅	HFS size	z
7,000 - 14,590	60	40	12	4
14,600 - 21,290	60	40	12	6

IT6 tolerance example:

HPR280Ø16.350H6MC1G-HP423

Bore diameter d₁ = 16.350 H6

G variant example:

HPR280GØ16.350+1-1MC1G-HP423

Special tool diameter d₁ = 16.350 +1 µm -1 µm

Dimensions in mm.

For associated HFS replaceable head holders, see page 460.

For cutting data recommendations, see end of chapter.

HPR replaceable head reamer

Finely adjustable design, straight fluted, for blind bores
HPR280

Design:

Reamer diameter:
Lead:
Cutting material:

7.000–21.290 mm
MA0A
PU620
PCD-tipped

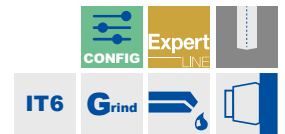
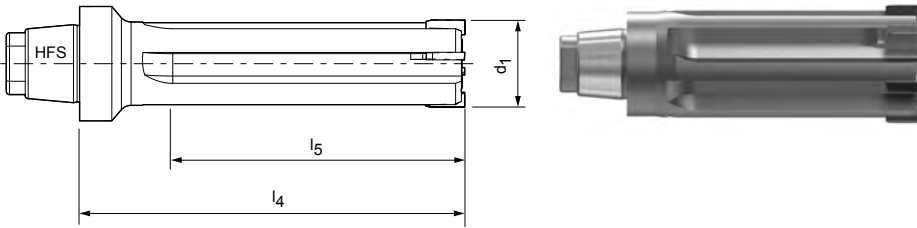

Configurable features



Bore diameter tolerance IT6:

- Diameter freely selectable in increments of 0.001 mm
- Can be ordered in tolerance IT6

Specification:

HPR280Ø[diameter][tolerance]MA0A-PU620

Bore diameter tolerance < IT6:

- Tolerances smaller than IT6 can be ordered as a special tool diameter (G variant, see page 373)

G variant specification:

HPR280GØ[diameter][tolerance]MA0A-PU620

Dimensions of configurable series IT6

d ₁	l ₄	l ₅	HFS size	z
7,000 - 14,590	60	40	12	4
14,600 - 21,290	60	40	12	6

IT6 tolerance example:

HPR280Ø16.350H6MA0A-PU620

Bore diameter d₁ = 16.350 H6

G variant example:

HPR280GØ16.350+1-1MA0A-PU620

Special tool diameter d₁ = 16.350 +1 µm -1 µm

Dimensions in mm.

For associated HFS replaceable head holders, see page 460.

For cutting data recommendations, see end of chapter.

HPR replaceable head reamer

Finely adjustable design, straight fluted, for blind bores
HPR280

Design:

Reamer diameter: 7.000–21.290 mm
Lead: M02G
Cutting material: HP625
Carbide
PVD-coated

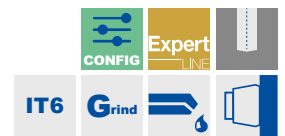
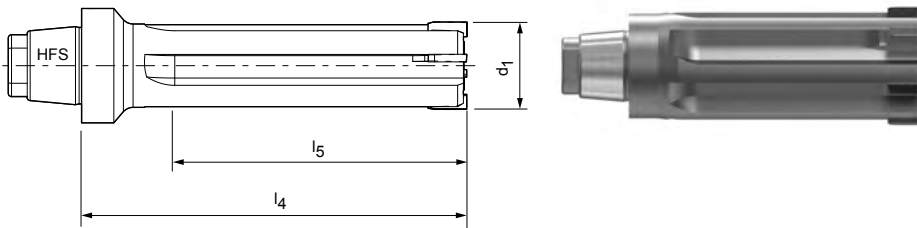

Configurable features



Bore diameter tolerance IT6:

- Diameter freely selectable in increments of 0.001 mm
- Can be ordered in tolerance IT6

Specification:

HPR280Ø[diameter][tolerance]M02G-HP625

Bore diameter tolerance < IT6:

- Tolerances smaller than IT6 can be ordered as a special tool diameter (G variant, see page 373)

G variant specification:

HPR280GØ[diameter][tolerance]M02G-HP625

Dimensions of configurable series IT6

d ₁	l ₄	l ₅	HFS size	z
7,000 - 14,590	60	40	12	4
14,600 - 21,290	60	40	12	6

IT6 tolerance example:

HPR280Ø16.350H6M02G-HP625

Bore diameter d₁ = 16.350 H6

G variant example:

HPR280GØ16.350+1-1M02G-HP625

Special tool diameter d₁ = 16.350 +1 µm -1 µm

Dimensions in mm.

For associated HFS replaceable head holders, see page 460.

For cutting data recommendations, see end of chapter.

HPR replaceable head reamer

Finely adjustable design, straight fluted, for blind bores
HPR250

Design:

Reamer diameter:
Lead:
Cutting material:

16.600-65.000 mm
ML2G
CU134
Uncoated cermet

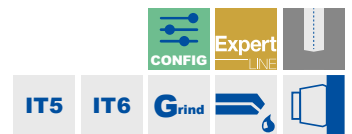
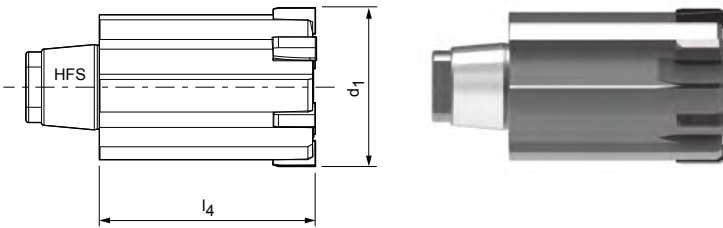

Configurable features



Bore diameter tolerance IT5/IT6:

- Diameter freely selectable in increments of 0.001 mm
- Can be ordered from tolerance IT5/IT6 depending on the diameter range
- > Ø30.000 IT5 | ≤ Ø30.000 IT6

Specification:

HPR250Ø[diameter][tolerance]ML2G-CU134

Bore diameter tolerance < IT5/IT6:

- Tolerances smaller than IT5/IT6 can be ordered as a special tool diameter (G variant, see page 373)

G variant specification:

HPR250GØ[diameter][tolerance]ML2G-CU134

Dimensions of configurable series IT5/IT6

d ₁	l ₄	l ₅	HFS size	z	Tolerance
16,600 - 21,290	25	-	10	6	IT6
21,300 - 24,990	27	-	12	6	IT6
25,000 - 28,590	35	-	14	6	IT6
29,000 - 32,290	35	-	16	6	IT5
32,300 - 36,990	41	-	16	6	IT5
37,000 - 41,190	41	-	20	8	IT5
41,200 - 44,900	47	-	20	8	IT5
45,000 - 65,000	47	-	24	8	IT5

IT5 tolerance example:

HPR250Ø35.350H5ML2G-CU134

Bore diameter d₁ = 35.350 H5

G variant example:

HPR250GØ35.350+1-1ML2G-CU134

Special tool diameter d₁ = 35.350 +1 µm -1 µm

Dimensions in mm.

For associated HFS replaceable head holders, see page 460.

For cutting data recommendations, see end of chapter.

HPR replaceable head reamer

Finely adjustable design, straight fluted, for blind bores
HPR250

Design:

Reamer diameter:

16.600-65.000 mm

Lead:

ML2G

Cutting material:

HP421

Carbide

PVD-coated

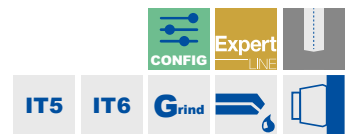
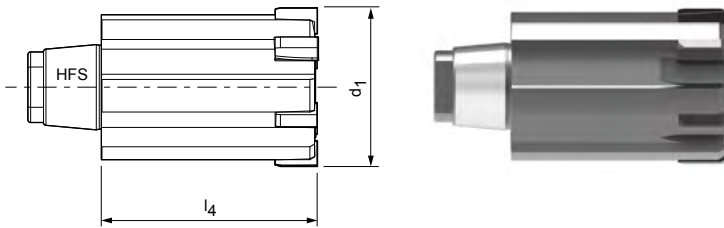

Configurable features

Bore diameter tolerance IT5/IT6:

- Diameter freely selectable in increments of 0.001 mm
- Can be ordered from tolerance IT5/IT6 depending on the diameter range
- > 030.000 IT5 | ≤ 030.000 IT6

Specification:

HPR250Ø[diameter][tolerance]ML2G-HP421

Bore diameter tolerance < IT5/IT6:

- Tolerances smaller than IT5/IT6 can be ordered as a special tool diameter (G variant, see page 373)

G variant specification:

HPR250GØ[diameter][tolerance]ML2G-HP421

Dimensions of configurable series IT5/IT6

d_1	l_4	l_5	HFS size	z	Tolerance
16,600 - 21,290	25	-	10	6	IT6
21,300 - 24,990	27	-	12	6	IT6
25,000 - 28,590	35	-	14	6	IT6
29,000 - 32,290	35	-	16	6	IT5
32,300 - 36,990	41	-	16	6	IT5
37,000 - 41,190	41	-	20	8	IT5
41,200 - 44,900	47	-	20	8	IT5
45,000 - 65,000	47	-	24	8	IT5

IT5 tolerance example:

HPR250Ø35.350H5ML2G-HP421

Bore diameter $d_1 = 35.350 \text{ H5}$

G variant example:

HPR250GØ35.350+1-1ML2G-HP421

Special tool diameter $d_1 = 35.350 +1 \mu\text{m} -1 \mu\text{m}$

Dimensions in mm.

For associated HFS replaceable head holders, see page 460.

For cutting data recommendations, see end of chapter.

HPR replaceable head reamer

Finely adjustable design, straight fluted, for blind bores
HPR250

Design:

Reamer diameter:
Lead:
Cutting material:

16.600-65.000 mm
M02G
HP421
Carbide
PVD-coated

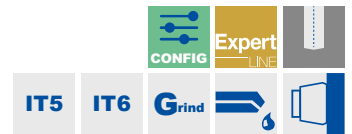
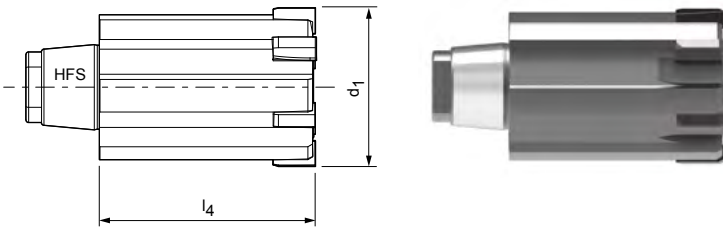

Configurable features



Bore diameter tolerance IT5/IT6:

- Diameter freely selectable in increments of 0.001 mm
- Can be ordered from tolerance IT5/IT6 depending on the diameter range
- > 030.000 IT5 | ≤ 030.000 IT6

Specification:

HPR250Ø[diameter][tolerance]M02G-HP421

Bore diameter tolerance < IT5/IT6:

- Tolerances smaller than IT5/IT6 can be ordered as a special tool diameter (G variant, see page 373)

G variant specification:

HPR250GØ[diameter][tolerance]M02G-HP421

Dimensions of configurable series IT5/IT6

d ₁	l ₄	l ₅	HFS size	z	Tolerance
16,600 - 21,290	25	-	10	6	IT6
21,300 - 24,990	27	-	12	6	IT6
25,000 - 28,590	35	-	14	6	IT6
29,000 - 32,290	35	-	16	6	IT5
32,300 - 36,990	41	-	16	6	IT5
37,000 - 41,190	41	-	20	8	IT5
41,200 - 44,900	47	-	20	8	IT5
45,000 - 65,000	47	-	24	8	IT5

IT5 tolerance example:

HPR250Ø35.350H5M02G-HP421

Bore diameter d₁ = 35.350 H5

G variant example:

HPR250GØ35.350+1-1M02G-HP421

Special tool diameter d₁ = 35.350 +1 µm -1 µm

Dimensions in mm.

For associated HFS replaceable head holders, see page 460.

For cutting data recommendations, see end of chapter.

HPR replaceable head reamer

Finely adjustable design, straight fluted, for blind bores
HPR250

Design:

Reamer diameter: 16.600-65.000 mm
Lead: MC1G
Cutting material: CP134
Cermet
PVD-coated

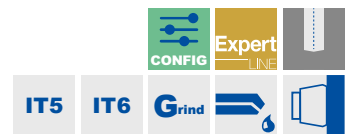
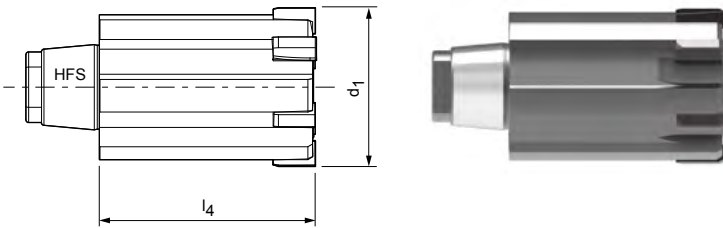

Configurable features

Bore diameter tolerance IT5/IT6:

- Diameter freely selectable in increments of 0.001 mm
- Can be ordered from tolerance IT5/IT6 depending on the diameter range
- > Ø30.000 IT5 | ≤ Ø30.000 IT6

Specification:

HPR250Ø[diameter][tolerance]MC1G-CP134

Bore diameter tolerance < IT5/IT6:

- Tolerances smaller than IT5/IT6 can be ordered as a special tool diameter (G variant, see page 373)

G variant specification:

HPR250GØ[diameter][tolerance]MC1G-CP134

Dimensions of configurable series IT5/IT6

d_1	l_4	l_5	HFS size	z	Tolerance
16,600 - 21,290	25	-	10	6	IT6
21,300 - 24,990	27	-	12	6	IT6
25,000 - 28,590	35	-	14	6	IT6
29,000 - 32,290	35	-	16	6	IT5
32,300 - 36,990	41	-	16	6	IT5
37,000 - 41,190	41	-	20	8	IT5
41,200 - 44,900	47	-	20	8	IT5
45,000 - 65,000	47	-	24	8	IT5

IT5 tolerance example:

HPR250Ø35.350H5MC1G-CP134

Bore diameter $d_1 = 35.350 \text{ H5}$

G variant example:

HPR250GØ35.350+1-1MC1G-CP134

Special tool diameter $d_1 = 35.350 +1 \mu\text{m} -1 \mu\text{m}$

Dimensions in mm.

* for surfaces $R_a < 2 \mu\text{m}$

For associated HFS replaceable head holders, see page 460.

For cutting data recommendations, see end of chapter.

HPR replaceable head reamer

Finely adjustable design, straight fluted, for blind bores
HPR250

Design:

Reamer diameter:
Lead:
Cutting material:

16.600-65.000 mm
MC1G
HP421
Carbide
PVD-coated

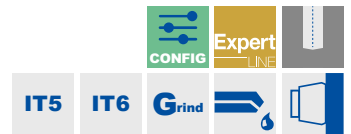
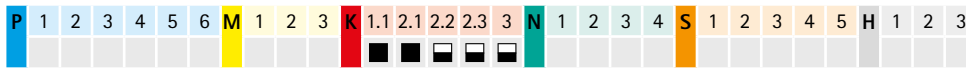
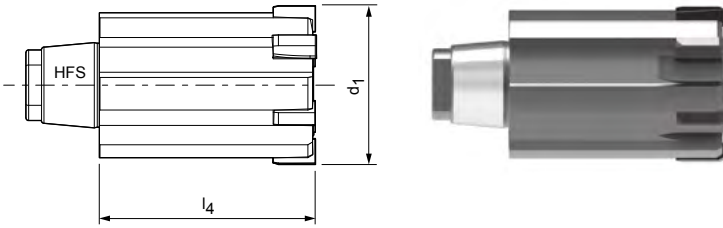

Configurable features



Bore diameter tolerance IT5/IT6:

- Diameter freely selectable in increments of 0.001 mm
- Can be ordered from tolerance IT5/IT6 depending on the diameter range
- > 030.000 IT5 | ≤ 030.000 IT6

Specification:

HPR250Ø[diameter][tolerance]MC1G-HP421

Bore diameter tolerance < IT5/IT6:

- Tolerances smaller than IT5/IT6 can be ordered as a special tool diameter (G variant, see page 373)

G variant specification:

HPR250GØ[diameter][tolerance]MC1G-HP421

Dimensions of configurable series IT5/IT6

d ₁	l ₄	l ₅	HFS size	z	Tolerance
16,600 - 21,290	25	-	10	6	IT6
21,300 - 24,990	27	-	12	6	IT6
25,000 - 28,590	35	-	14	6	IT6
29,000 - 32,290	35	-	16	6	IT5
32,300 - 36,990	41	-	16	6	IT5
37,000 - 41,190	41	-	20	8	IT5
41,200 - 44,900	47	-	20	8	IT5
45,000 - 65,000	47	-	24	8	IT5

IT5 tolerance example:

HPR250Ø35.350H5MC1G-HP421

Bore diameter d₁ = 35.350 H5

G variant example:

HPR250GØ35.350+1-1MC1G-HP421

Special tool diameter d₁ = 35.350 +1 µm -1 µm

Dimensions in mm.

For associated HFS replaceable head holders, see page 460.

For cutting data recommendations, see end of chapter.

HPR replaceable head reamer

Finely adjustable design, straight fluted, for blind bores
HPR250

Design:

Reamer diameter: 16.600-65.000 mm
Lead: MC1G
Cutting material: HP423
Carbide
PVD-coated

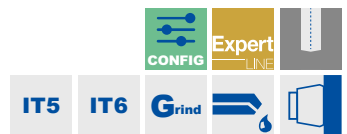
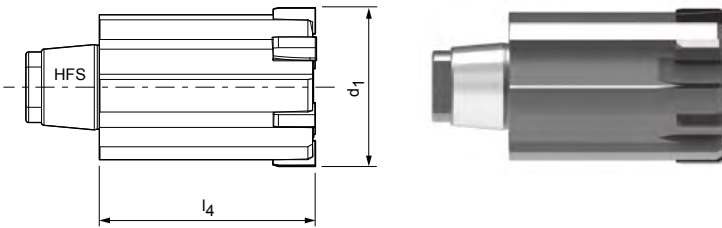

Configurable features

Bore diameter tolerance IT5/IT6:

- Diameter freely selectable in increments of 0.001 mm
- Can be ordered from tolerance IT5/IT6 depending on the diameter range
- > 030.000 IT5 | ≤ 030.000 IT6

Specification:

HPR250Ø[diameter][tolerance]MC1G-HP423

Bore diameter tolerance < IT5/IT6:

- Tolerances smaller than IT5/IT6 can be ordered as a special tool diameter (G variant, see page 373)

G variant specification:

HPR250GØ[diameter][tolerance]MC1G-HP423

Dimensions of configurable series IT5/IT6

d_1	l_4	l_5	HFS size	z	Tolerance
16,600 - 21,290	25	-	10	6	IT6
21,300 - 24,990	27	-	12	6	IT6
25,000 - 28,590	35	-	14	6	IT6
29,000 - 32,290	35	-	16	6	IT5
32,300 - 36,990	41	-	16	6	IT5
37,000 - 41,190	41	-	20	8	IT5
41,200 - 44,900	47	-	20	8	IT5
45,000 - 65,000	47	-	24	8	IT5

IT5 tolerance example:

HPR250Ø35.350H5MC1G-HP423

Bore diameter $d_1 = 35.350 \text{ H5}$

G variant example:

HPR250GØ35.350+1-1MC1G-HP423

Special tool diameter $d_1 = 35.350 +1 \mu\text{m} -1 \mu\text{m}$

Dimensions in mm.

For associated HFS replaceable head holders, see page 460.

For cutting data recommendations, see end of chapter.

HPR replaceable head reamer

Finely adjustable design, straight fluted, for blind bores
HPR250

Design:

Reamer diameter:
Lead:
Cutting material:

16.600-65.000 mm
MA0A
PU620
PCD-tipped

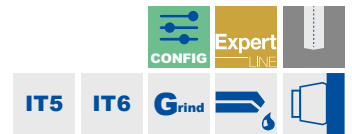
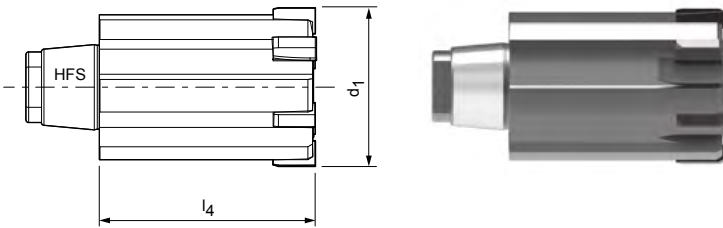

Configurable features



Bore diameter tolerance IT5/IT6:

- Diameter freely selectable in increments of 0.001 mm
- Can be ordered from tolerance IT5/IT6 depending on the diameter range
- > 030.000 IT5 | ≤ 030.000 IT6

Specification:

HPR250Ø[diameter][tolerance]MA0A-PU620

Bore diameter tolerance < IT5/IT6:

- Tolerances smaller than IT5/IT6 can be ordered as a special tool diameter (G variant, see page 373)

G variant specification:

HPR250GØ[diameter][tolerance]MA0A-PU620

Dimensions of configurable series IT5/IT6

d ₁	l ₄	l ₅	HFS size	z	Tolerance
16,600 - 21,290	25	-	10	6	IT6
21,300 - 24,990	27	-	12	6	IT6
25,000 - 28,590	35	-	14	6	IT6
29,000 - 32,290	35	-	16	6	IT5
32,300 - 36,990	41	-	16	6	IT5
37,000 - 41,190	41	-	20	8	IT5
41,200 - 44,900	47	-	20	8	IT5
45,000 - 65,000	47	-	24	8	IT5

IT5 tolerance example:

HPR250Ø35.350H5MA0A-PU620

Bore diameter d₁ = 35.350 H5

G variant example:

HPR250GØ35.350+1-1MA0A-PU620

Special tool diameter d₁ = 35.350 +1 µm -1 µm

Dimensions in mm.

For associated HFS replaceable head holders, see page 460.

For cutting data recommendations, see end of chapter.

HPR replaceable head reamer

Finely adjustable design, straight fluted, for blind bores
HPR250

Design:

Reamer diameter: 16.600-65.000 mm
Lead: M02G
Cutting material: HP625
Carbide
PVD-coated

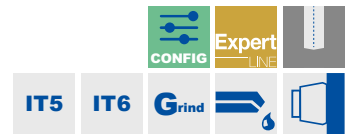
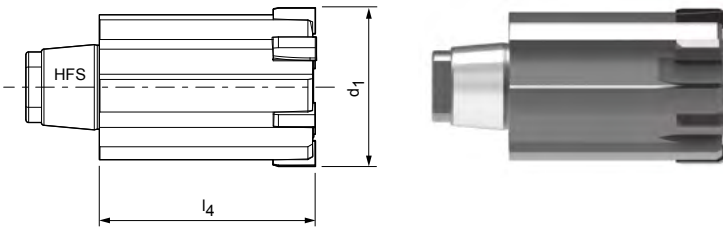

Configurable features

Bore diameter tolerance IT5/IT6:

- Diameter freely selectable in increments of 0.001 mm
- Can be ordered from tolerance IT5/IT6 depending on the diameter range
- > 030.000 IT5 | ≤ 030.000 IT6

Specification:

HPR250Ø[diameter][tolerance]M02G-HP625

Bore diameter tolerance < IT5/IT6:

- Tolerances smaller than IT5/IT6 can be ordered as a special tool diameter (G variant, see page 373)

G variant specification:

HPR250GØ[diameter][tolerance]M02G-HP625

Dimensions of configurable series IT5/IT6

d_1	l_4	l_5	HFS size	z	Tolerance
16,600 - 21,290	25	-	10	6	IT6
21,300 - 24,990	27	-	12	6	IT6
25,000 - 28,590	35	-	14	6	IT6
29,000 - 32,290	35	-	16	6	IT5
32,300 - 36,990	41	-	16	6	IT5
37,000 - 41,190	41	-	20	8	IT5
41,200 - 44,900	47	-	20	8	IT5
45,000 - 65,000	47	-	24	8	IT5

IT5 tolerance example:

HPR250Ø35.350H5M02G-HP625

Bore diameter $d_1 = 35.350 \text{ H5}$

G variant example:

HPR250GØ35.350+1-1M02G-HP625

Special tool diameter $d_1 = 35.350 +1 \mu\text{m} -1 \mu\text{m}$

Dimensions in mm.

For associated HFS replaceable head holders, see page 460.

For cutting data recommendations, see end of chapter.

Cutting data recommendations for HPR replaceable head reamers

Feed and cutting speed

HPR131 | HPR231 | HPR180 | HPR280

Cutting material: HP421 | Lead: ME1G | ML2G

MMG*		Workpiece material	Strength/hardness [N/mm ²] [HRC]	Cutting speed v _c (m/min)			Feed f _z (mm/z) with tool diameter	
				Internal cooling	External cooling	MQL	z 4	z 6
							7.000 - 9.590	9.600 - 21.290
P	P3.1	Tool, bearing, spring and high-speed steels**	< 800					
	P3.2	Tool, bearing, spring and high-speed steels**	< 1000	100	100	120	0.100	0.200
	P3.3	Tool, bearing, spring and high-speed steels**	< 1500	100	100	120	0.100	0.200
	P5.1	Cast steel		35	35	35	0.070	0.070

HPR150 | HPR250

Cutting material: CU134 | Lead: ML2G

MMG*		Workpiece material	Strength/hardness [N/mm ²] [HRC]	Cutting speed v _c (m/min)			Feed f _z (mm/z) with tool diameter		
				Internal cooling	External cooling	MQL	z 6	z 8	
							16.600 - 36.990	37.000 - 65.000	
P	P1	P1.1	Structural, free-cutting, case hardened and heat-treated steels, non-alloy	< 700	140	100	120	0.200	0.250
		P1.2	Structural, free-cutting, case hardened and heat-treated steels, non-alloy	< 1200	140	100	120	0.200	0.250
	P2	P2.1	Nitrided, case hardened and heat-treated steels, alloy	< 900	140	100	120	0.200	0.250
		P2.2	Nitrided, case hardened and heat-treated steels, alloy	< 1400	140	100	120	0.200	0.250
	P3	P3.1	Tool, bearing, spring and high-speed steels**	< 800	140	100	120	0.200	0.250
		P3.2	Tool, bearing, spring and high-speed steels**	< 1000					
P3.3		Tool, bearing, spring and high-speed steels**	< 1500						

HPR180 | HPR280

Cutting material: CU134 | Lead: ML2G

MMG*		Workpiece material	Strength/hardness [N/mm ²] [HRC]	Cutting speed v _c (m/min)			Feed f _z (mm/z) with tool diameter		
				Internal cooling	External cooling	MQL	z 4	z 6	
							7.000 - 14.590	14.600 - 21.290	
P	P1	P1.1	Structural, free-cutting, case hardened and heat-treated steels, non-alloy	< 700	140	100	120	0.150	0.200
		P1.2	Structural, free-cutting, case hardened and heat-treated steels, non-alloy	< 1200	140	100	120	0.150	0.200
	P2	P2.1	Nitrided, case hardened and heat-treated steels, alloy	< 900	140	100	120	0.150	0.200
		P2.2	Nitrided, case hardened and heat-treated steels, alloy	< 1400	140	100	120	0.150	0.200
	P3	P3.1	Tool, bearing, spring and high-speed steels**	< 800	140	100	120	0.150	0.200
		P3.2	Tool, bearing, spring and high-speed steels**	< 1000					
P3.3		Tool, bearing, spring and high-speed steels**	< 1500						

* MAPAL machining groups

** If the alloy parts Cr, Mo, Ni, V, W in total > 8% then select the next highest MAPAL machining group.

HPR110 | HPR210 | HPR150 | HPR250

Cutting material: HP421 | Lead: ME1G | ML2G

MMG*		Workpiece material	Strength/hardness [N/mm ²] [HRC]	Cutting speed v _c (m/min)			Feed f _z (mm/z) with tool diameter	
				Internal cooling	External cooling	MQL	z 6	z 8
							15.600 - 29.990	30.00 - 65.00
P	P3.1	Tool, bearing, spring and high-speed steels**	< 800	120	100	120	0.200	0.200
	P3.2	Tool, bearing, spring and high-speed steels**	< 1000	100	100	120	0.200	0.200
	P3.3	Tool, bearing, spring and high-speed steels**	< 1500	100	100	120	0.200	0.200
	P5.1	Cast steel		35	35	35	0.070	0.070

HPR110 | HPR210

Cutting material: CU134 | Lead: ME1G

MMG*		Workpiece material	Strength/hardness [N/mm ²] [HRC]	Cutting speed v _c (m/min)			Feed f _z (mm/z) with tool diameter		
				Internal cooling	External cooling	MQL	z 6	z 8	
							15.600 - 29.990	30.000 - 65.000	
P	P1	P1.1	Structural, free-cutting, case hardened and heat-treated steels, non-alloy	< 700	140	100	120	0.200	0.250
		P1.2	Structural, free-cutting, case hardened and heat-treated steels, non-alloy	< 1200	140	100	120	0.200	0.250
	P2	P2.1	Nitrided, case hardened and heat-treated steels, alloy	< 900	140	100	120	0.200	0.250
		P2.2	Nitrided, case hardened and heat-treated steels, alloy	< 1400	140	100	120	0.200	0.250
	P3	P3.1	Tool, bearing, spring and high-speed steels**	< 800	140	100	120	0.200	0.250
		P3.2	Tool, bearing, spring and high-speed steels**	< 1000					
P3.3		Tool, bearing, spring and high-speed steels**	< 1500						

HPR131 | HPR231

Cutting material: CU134 | Lead: ME1G

MMG*		Workpiece material	Strength/hardness [N/mm ²] [HRC]	Cutting speed v _c (m/min)			Feed f _z (mm/z) with tool diameter		
				Internal cooling	External cooling	MQL	z 4	z 6	
							7.000 - 9.590	9.600 - 18.590	
P	P1	P1.1	Structural, free-cutting, case hardened and heat-treated steels, non-alloy	< 700	140	100	120	0.150	0.200
		P1.2	Structural, free-cutting, case hardened and heat-treated steels, non-alloy	< 1200	140	100	120	0.150	0.200
	P2	P2.1	Nitrided, case hardened and heat-treated steels, alloy	< 900	140	100	120	0.150	0.200
		P2.2	Nitrided, case hardened and heat-treated steels, alloy	< 1400	140	100	120	0.150	0.200
	P3	P3.1	Tool, bearing, spring and high-speed steels**	< 800	140	100	120	0.150	0.200
		P3.2	Tool, bearing, spring and high-speed steels**	< 1000					
P3.3		Tool, bearing, spring and high-speed steels**	< 1500						

The specified cutting values are guide values.

The optimum data for the respective machining task should be determined during the test or machining.

Cutting data recommendations for HPR replaceable head reamers

Feed and cutting speed

HPR131 | HPR231 | HPR180 | HPR280

Cutting material: HP421 | Lead: MF1G | MO2G

MMG*	Workpiece material		Strength/hardness [N/mm ²] [HRC]	Cutting speed v _c (m/min)		
				Internal cooling	External cooling	MQL
P	P4	P4.1	Stainless steels, ferritic and martensitic	35	35	35
	P6	P6.1	Stainless cast steel, ferritic and martensitic	35	35	35
M	M1	M1.1	Stainless steels, austenitic	< 700	35	35
		M1.2	Stainless steels, ferritic/austenitic (duplex)	< 1000	35	35
	M2	M2.1	Stainless/heat-resistant cast steel, austenitic	< 700	35	35
	M3	M3.1	Stainless cast steel, ferritic/austenitic (duplex)	< 1000	35	35

HPR110 | HPR210 | HPR150 | HPR250

Cutting material: HP421 | Lead: MF1G | MO2G

MMG*	Workpiece material		Strength/hardness [N/mm ²] [HRC]	Cutting speed v _c (m/min)		
				Internal cooling	External cooling	MQL
P	P4	P4.1	Stainless steels, ferritic and martensitic	35	35	35
	P6	P6.1	Stainless cast steel, ferritic and martensitic	35	35	35
M	M1	M1.1	Stainless steels, austenitic	< 700	35	35
		M1.2	Stainless steels, ferritic/austenitic (duplex)	< 1000	35	35
	M2	M2.1	Stainless/heat-resistant cast steel, austenitic	< 700	35	35
	M3	M3.1	Stainless cast steel, ferritic/austenitic (duplex)	< 1000	35	35

Feed f_z (mm/z) with tool diameter			
HPR131 HPR231		HPR180 HPR280	
z4	z6	z4	z6
7.000-9.590	9.600-18.590	7.000-14.590	14.600-21.290
0.070	0.070	0.070	0.070
0.070	0.070	0.070	0.070
0.070	0.070	0.070	0.070
0.070	0.070	0.070	0.070
0.070	0.070	0.070	0.070

Feed f_z (mm/z) with tool diameter			
HPR110 HPR210		HPR150 HPR250	
z6	z8	z6	z8
15.600-29.990	30.000-65.000	16.600-36.990	37.000-65.000
0.070	0.070	0.070	0.070
0.070	0.070	0.070	0.070
0.070	0.070	0.070	0.070
0.070	0.070	0.070	0.070
0.070	0.070	0.070	0.070

The specified cutting values are guide values.

The optimum data for the respective machining task should be determined during the test or machining.

Cutting data recommendations for HPR replaceable head reamers

Feed and cutting speed

HPR130 | HPR230 | HPR180 | HPR280

Cutting material: HP423 | Lead: MC1G

MMG*	Workpiece material	Strength/hardness [N/mm ²] [HRC]	Cutting speed v _c (m/min)			
			Internal cooling	External cooling	MQL	
K	K1 K1.1	Cast iron with lamellar graphite (grey cast iron), GJL	< 300	140	100	120
		Cast iron with spheroidal graphite, GJS	< 500	140	100	120
	K2 K2.2	Cast iron with spheroidal graphite, GJS	≤ 800			
		Cast iron with spheroidal graphite, GJS	> 800			

HPR100 | HPR200 | HPR150 | HPR250

Cutting material: CP134 | Lead: MC1G

MMG*	Workpiece material	Strength/hardness [N/mm ²] [HRC]	Cutting speed v _c (m/min)			
			Internal cooling	External cooling	MQL	
K	K1 K1.1	Cast iron with lamellar graphite (grey cast iron), GJL	< 300	140	100	120
		Cast iron with spheroidal graphite, GJS	< 500	140	100	120
	K2 K2.2	Cast iron with spheroidal graphite, GJS	≤ 800			
		Cast iron with spheroidal graphite, GJS	> 800			

HPR130 | HPR180

Cutting material: HC419 | Lead: MC1G

MMG*	Workpiece material	Strength/hardness [N/mm ²] [HRC]	Cutting speed v _c (m/min)			
			Internal cooling	External cooling	MQL	
K	K1 K1.1	Cast iron with lamellar graphite (grey cast iron), GJL	< 300	120	100	120

HPR100 | HPR150

Cutting material: HC419 | Lead: MC1G

MMG*	Workpiece material	Strength/hardness [N/mm ²] [HRC]	Cutting speed v _c (m/min)			
			Internal cooling	External cooling	MQL	
K	K1 K1.1	Cast iron with lamellar graphite (grey cast iron), GJL	< 300	120	100	120

Feed f_z (mm/z) with tool diameter			
HPR130 HPR230		HPR180 HPR280	
z4	z6	z4	z6
7.000-9.590	9.600-18.590	7.000-14.590	14.600-21.290
0.150	0.200	0.150	0.200
0.150	0.200	0.150	0.200

Feed f_z (mm/z) with tool diameter			
HPR100 HPR200		HPR150 HPR250	
z6	z8	z6	z8
15.600-29.990	30.000-65.000	16.600-36.990	37.000-65.000
0.200	0.300	0.200	0.300
0.200	0.300	0.200	0.300

Feed f_z (mm/z) with tool diameter			
HPR130		HPR180	
z 4	z 6	z 4	z 6
7.000-9.590	9.600-18.590	7.000-14.590	14.600-21.290
0.150	0.200	0.150	0.200

Feed f_z (mm/z) with tool diameter			
HPR100		HPR150	
z6	z8	z6	z8
15.600-29.990	30.000-65.000	16.600-36.990	37.000-65.000
0.150	0.200	0.150	0.200

The specified cutting values are guide values.

The optimum data for the respective machining task should be determined during the test or machining.

Cutting data recommendations for HPR replaceable head reamers

Feed and cutting speed

HPR130 | HPR230 | HPR180 | HPR280

Cutting material: HP421 | Lead: MC1G

MMG*	Workpiece material	Strength/hardness [N/mm ²] [HRC]	Cutting speed v _c (m/min)		
			Internal cooling	External cooling	MQL
K2	K2.1 Cast iron with spheroidal graphite, GJS	< 500	120	100	120
	K2.2 Cast iron with spheroidal graphite, GJS	≤ 800			
	K2.3 Cast iron with spheroidal graphite, GJS	> 800			

HPR100 | HPR200 | HPR150 | HPR250

Cutting material: HP421 | Lead: MC1G

MMG*	Workpiece material	Strength/hardness [N/mm ²] [HRC]	Cutting speed v _c (m/min)		
			Internal cooling	External cooling	MQL
K2	K2.1 Cast iron with spheroidal graphite, GJS	< 500	120	100	120
	K2.2 Cast iron with spheroidal graphite, GJS	≤ 800			
	K2.3 Cast iron with spheroidal graphite, GJS	> 800			

HPR130 | HPR230 | HPR180 | HPR280

Cutting material: HP423 | Lead: MC1G

MMG*	Workpiece material	Strength/hardness [N/mm ²] [HRC]	Cutting speed v _c (m/min)			
			Internal cooling	External cooling	MQL	
K	K2	K2.1 Cast iron with spheroidal graphite, GJS				
		K2.2 Cast iron with spheroidal graphite, GJS	120	100	120	
		K2.3 Cast iron with spheroidal graphite, GJS	120	100	120	
	K3	K3.1 Cast iron with spheroidal graphite, GJV; malleable cast iron, GJM	< 500	90	70	90
		K3.2 Cast iron with spheroidal graphite, GJV; malleable cast iron, GJM	> 500	90	70	90

HPR100 | HPR200 | HPR150 | HPR250

Cutting material: HP423 | Lead: MC1G

MMG*	Workpiece material	Strength/hardness [N/mm ²] [HRC]	Cutting speed v _c (m/min)			
			Internal cooling	External cooling	MQL	
K	K2	K2.1 Cast iron with spheroidal graphite, GJS				
		K2.2 Cast iron with spheroidal graphite, GJS	120	100	120	
		K2.3 Cast iron with spheroidal graphite, GJS	120	100	120	
	K3	K3.1 Cast iron with spheroidal graphite, GJV; malleable cast iron, GJM	< 500	90	70	90
		K3.2 Cast iron with spheroidal graphite, GJV; malleable cast iron, GJM	> 500	90	70	90

Feed f_z (mm/z) with tool diameter			
HPR130 HPR230		HPR180 HPR280	
z4	z6	z4	z6
7.000-9.590	9.600-18.590	7.000-14.590	14.600-21.290
0.150	0.200	0.150	0.200

Feed f_z (mm/z) with tool diameter			
HPR100 HPR200		HPR150 HPR250	
z6	z8	z6	z8
15.600-29.990	30.000-65.000	16.600-36.990	37.000-65.000
0.150	0.200	0.150	0.200

Feed f_z (mm/z) with tool diameter			
HPR130 HPR230		HPR180 HPR280	
z4	z6	z4	z6
7.000-9.590	9.600-18.590	7.000-14.590	14.600-21.290
0.150	0.200	0.150	0.200
0.150	0.200	0.150	0.200
0.150	0.200	0.150	0.200
0.150	0.200	0.150	0.200

Feed f_z (mm/z) with tool diameter			
HPR100 HPR200		HPR150 HPR250	
z6	z8	z6	z8
15.600-29.990	30.000-65.000	16.600-36.990	37.000-65.000
0.150	0.200	0.150	0.200
0.150	0.200	0.150	0.200
0.150	0.200	0.150	0.200
0.150	0.200	0.150	0.200

The specified cutting values are guide values.

The optimum data for the respective machining task should be determined during the test or machining.

Cutting data recommendations for HPR replaceable head reamers

Feed and cutting speed

HPR130 | HPR230 | HPR180 | HPR280

Cutting material: PU620 | Lead: MA0A

MMG*	Workpiece material	Strength/hardness [N/mm ²] [HRC]	Cutting speed v _c (m/min)			
			Internal cooling	External cooling	MQL	
N	N1	N1.1 Aluminium, non-alloy and alloy < 3 % Si	130	100	120	
		N1.2 Aluminium, alloy ≤ 7 % Si	130	100	120	
		N1.3 Aluminium, alloyed > 7 - 12 % Si	130	100	120	
		N1.4 Aluminium, alloy > 12 % Si	130	100	120	
	N2	N2.1 Copper, unalloyed and low-alloyed	< 300	130	100	120
		N2.2 Copper, alloy	> 300	130	100	120
		N2.3 Brass, bronze, gunmetal	< 1200	130	100	120

HPR100 | HPR200 | HPR150 | HPR250

Cutting material: PU620 | Lead: MA0A

MMG*	Workpiece material	Strength/hardness [N/mm ²] [HRC]	Cutting speed v _c (m/min)			
			Internal cooling	External cooling	MQL	
N	N1	N1.1 Aluminium, non-alloy and alloy < 3 % Si	130	100	120	
		N1.2 Aluminium, alloy ≤ 7 % Si	130	100	120	
		N1.3 Aluminium, alloy > 7-12 % Si	130	100	120	
		N1.4 Aluminium, alloy > 12 % Si	130	100	120	
	N2	N2.1 Copper, unalloyed and low-alloyed	< 300	130	100	120
		N2.2 Copper, alloy	> 300	130	100	120
		N2.3 Brass, bronze, gunmetal	< 1200	130	100	120

Feed f_z (mm/z) with tool diameter			
HPR130 HPR230		HPR180 HPR280	
z4	z6	z4	z6
7.000-9.590	9.600-18.590	7.000-14.590	14.600-21.290
0.150	0.250	0.150	0.250
0.150	0.250	0.150	0.250
0.150	0.250	0.150	0.250
0.150	0.250	0.150	0.250
0.150	0.250	0.150	0.250
0.150	0.250	0.150	0.250
0.150	0.250	0.150	0.250

Feed f_z (mm/z) with tool diameter			
HPR100 HPR200		HPR150 HPR250	
z6	z8	z6	z8
15.600-29.990	30.000-65.000	16.600-36.990	37.000-65.000
0.150	0.250	0.150	0.250
0.150	0.250	0.150	0.250
0.150	0.250	0.150	0.250
0.150	0.250	0.150	0.250
0.150	0.250	0.150	0.250
0.150	0.250	0.150	0.250
0.150	0.250	0.150	0.250

The specified cutting values are guide values.

The optimum data for the respective machining task should be determined during the test or machining.

Cutting data recommendations for HPR replaceable head reamers

Feed and cutting speed

HPR180 | HPR280

Cutting material: HP625 | Lead: MO2G

MMG*		Workpiece material	Strength/hardness [N/mm ²] [HRC]	Cutting speed v_c (m/min)			Feed f_z (mm/z) with tool diameter		
				Internal cooling	External cooling	MQL	z 4	z 6	
							7.000-14.590	14.600-21.290	
S	S1	S1.1	Titanium, titanium alloys	< 400	35	20	25	0.060	0.080
	S2	S2.1	Titanium, titanium alloys	< 1200	35	20	25	0.060	0.080
		S2.2	Titanium, titanium alloys	> 1200	35	20	25	0.060	0.080
	S3	S3.1	Nickel, unalloyed and alloyed	< 900	30	15	25	0.060	0.080
		S3.2	Nickel, unalloyed and alloyed	> 900	30	15	25	0.060	0.080
	S4	S4.1	High-temperature super alloy Ni, Co and Fe-based		25	15	20	0.060	0.080
	S5	S5.1	Tungsten and molybdenum alloys		25	15	20	0.060	0.080

HPR131 | HPR231

Cutting material: HP625 | Lead: MF1G

MMG*		Workpiece material	Strength/hardness [N/mm ²] [HRC]	Cutting speed v_c (m/min)			Feed f_z (mm/z) with tool diameter		
				Internal cooling	External cooling	MQL	z 4	z 6	
							7.000-9.590	9.600-18.590	
S	S1	S1.1	Titanium, titanium alloys	< 400	35	20	25	0.060	0.100
	S2	S2.1	Titanium, titanium alloys	< 1200	35	20	25	0.060	0.100
		S2.2	Titanium, titanium alloys	> 1200	35	20	25	0.060	0.100
	S3	S3.1	Nickel, unalloyed and alloyed	< 900	30	15	25	0.060	0.100
		S3.2	Nickel, unalloyed and alloyed	> 900	30	15	25	0.060	0.100
	S4	S4.1	High-temperature super alloy Ni, Co and Fe-based		25	15	20	0.060	0.100
	S5	S5.1	Tungsten and molybdenum alloys		25	15	20	0.060	0.100

HPR110 | HPR210

Cutting material: HP625 | Lead: MF1G

MMG*	Workpiece material		Strength/hardness [N/mm ²] [HRC]	Cutting speed v_c (m/min)			Feed f_z (mm/z) with tool diameter		
				Internal cooling	External cooling	MQL	z 6	z 8	
							15.600-29.990	30.000-65.000	
S	S1	S1.1	Titanium, titanium alloys	< 400	35	20	25	0.100	0.100
	S2	S2.1	Titanium, titanium alloys	< 1200	35	20	25	0.100	0.100
		S2.2	Titanium, titanium alloys	> 1200	35	20	25	0.100	0.100
	S3	S3.1	Nickel, unalloyed and alloyed	< 900	30	15	25	0.100	0.100
		S3.2	Nickel, unalloyed and alloyed	> 900	30	15	25	0.100	0.100
	S4	S4.1	High-temperature super alloy Ni, Co and Fe-based		25	15	20	0.100	0.100
	S5	S5.1	Tungsten and molybdenum alloys		25	15	20	0.100	0.100

HPR150 | HPR250

Cutting material: HP625 | Lead: MO2G

MMG*	Workpiece material		Strength/hardness [N/mm ²] [HRC]	Cutting speed v_c (m/min)			Feed f_z (mm/z) with tool diameter		
				Internal cooling	External cooling	MQL	z 6	z 8	
							16.600-36.990	37.000-65.000	
S	S1	S1.1	Titanium, titanium alloys	< 400	35	20	25	0.080	0.080
	S2	S2.1	Titanium, titanium alloys	< 1200	35	20	25	0.080	0.080
		S2.2	Titanium, titanium alloys	> 1200	35	20	25	0.080	0.080
	S3	S3.1	Nickel, unalloyed and alloyed	< 900	30	15	25	0.080	0.080
		S3.2	Nickel, unalloyed and alloyed	> 900	30	15	25	0.080	0.080
	S4	S4.1	High-temperature super alloy Ni, Co and Fe-based		25	15	20	0.080	0.080
	S5	S5.1	Tungsten and molybdenum alloys		25	15	20	0.080	0.080

The specified cutting values are guide values.

The optimum data for the respective machining task should be determined during the test or machining.

Stock removals during reaming

MMG*	Workpiece material	Strength/hardness [N/mm ²] [HRC]
P	P1.1 Structural, free-cutting, case hardened and heat-treated steels, non-alloy	< 700
	P1.2 Structural, free-cutting, case hardened and heat-treated steels, non-alloy	< 1200
	P2.1 Nitrided, case hardened and heat-treated steels, alloy	< 900
	P2.2 Nitrided, case hardened and heat-treated steels, alloy	< 1400
	P3.1 Tool, bearing, spring and high-speed steels**	< 800
	P3.2 Tool, bearing, spring and high-speed steels**	< 1000
	P3.3 Tool, bearing, spring and high-speed steels**	< 1500
	P4.1 Stainless steels, ferritic and martensitic	
	P5.1 Cast steel	
P6.1 Stainless cast steel, ferritic and martensitic		
M	M1.1 Stainless steels, austenitic	< 700
	M1.2 Stainless steels, ferritic/austenitic (duplex)	< 1000
	M2.1 Stainless/heat-resistant cast steel, austenitic	< 700
	M3.1 Stainless cast steel, ferritic/austenitic (duplex)	< 1000
K	K1.1 Cast iron with lamellar graphite (grey cast iron), GJL	< 300
	K2.1 Cast iron with spheroidal graphite, GJS	< 500
	K2.2 Cast iron with spheroidal graphite, GJS	≤ 800
	K2.3 Cast iron with spheroidal graphite, GJS	> 800
	K3.1 Cast iron with spheroidal graphite, GJV; malleable cast iron, GJM	< 500
	K3.2 Cast iron with spheroidal graphite, GJV; malleable cast iron, GJM	> 500
N	N1.1 Aluminium, non-alloy and alloy < 3 % Si	
	N1.2 Aluminium, alloy ≤ 7 % Si	
	N1.3 Aluminium, alloy > 7-12 % Si	
	N1.4 Aluminium, alloy > 12 % Si	
	N2.1 Copper, unalloyed and low-alloyed	< 300
	N2.2 Copper, alloy	> 300
	N2.3 Brass, bronze, gunmetal	< 1200
	N4.1 Plastic, thermoplastics	
	N4.2 Plastic, thermosets	
	N4.3 Plastic, foams	
C	C1.1 Plastic matrix, aramide fibre-reinforced (AFRP)	
	C1.2 Plastic matrix (thermosetting), CFRP/GFRP	
	C1.3 Plastic matrix (thermoplastic), CFRP/GFRP	
	C2.1 Carbon matrix, carbon fibre-reinforced (CFC)	
S	S1.1 Titanium, titanium alloys	< 400
	S2.1 Titanium, titanium alloys	< 1200
	S2.2 Titanium, titanium alloys	> 1200
	S3.1 Nickel, unalloyed and alloyed	< 900
	S3.2 Nickel, unalloyed and alloyed	> 900
	S4.1 High-temperature super alloy Ni, Co and Fe-based	
S5.1 Tungsten and molybdenum alloys		
H	H1.1 Hardened steel / cast steel	< 44
	H1.2 Hardened steel / cast steel	< 55
	H2.1 Hardened steel / cast steel	< 60
	H2.2 Hardened steel / cast steel	< 65
	H2.3 Hardened steel / cast steel	< 68
	H3.1 Wear-resistant cast/chill casting, GJN	

* MAPAL machining groups

** If the alloy parts Cr, Mo, Ni, V, W in total > 8% then select the next highest MAPAL machining group.

	Stock removal a_p (mm) during reaming				
	< Ø5mm	Ø5-8mm	Ø8-12mm	Ø12-18mm	> Ø18mm
	0.100	0.100	0.150	0.150	0.150
	0.100	0.100	0.100	0.150	0.150
	0.100	0.100	0.150	0.150	0.150
	0.100	0.100	0.100	0.150	0.150
	0.100	0.100	0.150	0.150	0.150
	0.100	0.100	0.150	0.150	0.150
	0.100	0.100	0.100	0.150	0.150
	0.100	0.100	0.100	0.100	0.100
	0.100	0.100	0.100	0.150	0.150
	0.100	0.100	0.100	0.100	0.100
	0.100	0.100	0.100	0.100	0.100
	0.100	0.100	0.100	0.100	0.100
	0.100	0.100	0.100	0.100	0.100
	0.150	0.150	0.150	0.150	0.150
	0.150	0.150	0.150	0.150	0.150
	0.150	0.150	0.150	0.150	0.150
	0.100	0.150	0.150	0.150	0.150
	0.150	0.150	0.150	0.150	0.150
	0.100	0.150	0.150	0.150	0.150
	0.150	0.150	0.150	0.150	0.150
	0.150	0.150	0.150	0.150	0.150
	0.150	0.150	0.150	0.150	0.150
	0.150	0.150	0.150	0.150	0.150
	0.150	0.150	0.150	0.150	0.150
	0.200	0.200	0.200	0.200	0.200
	0.200	0.200	0.200	0.200	0.200
	0.200	0.200	0.200	0.200	0.200
	0.200	0.200	0.200	0.200	0.200
	0.200	0.200	0.200	0.200	0.200
	0.200	0.200	0.200	0.200	0.200
	0.100	0.100	0.100	0.100	0.100
	0.100	0.100	0.100	0.100	0.100
	0.100	0.100	0.100	0.100	0.100
	0.100	0.100	0.100	0.100	0.100
	0.100	0.100	0.100	0.100	0.100
	0.100	0.100	0.100	0.100	0.100
	0.100	0.100	0.100	0.100	0.100
	0.075	0.075	0.075	0.075	0.075
	0.050	0.050	0.075	0.075	0.075
	0.050	0.050	0.075	0.075	0.075
	0.050	0.050	0.075	0.075	0.075
	0.050	0.050	0.075	0.075	0.075
	0.100	0.050	0.075	0.075	0.075

The specified cutting values are guide values.

The optimum data for the respective machining task should be determined during the test or machining.

Tool features of HFS systems in detail



HFS axial clamping system

Also available for module and hollow shank taper connections



- 1 Different holder variants**
e.g. cylindrical shank, HSK-A
- 2 Taper for easy, highly accurate centring**
- 3 Face connection for rigidity and stability**
- 4 Internal coolant supply**
Exit directly at the cutting edge
- 5 Sturdy, precision clamping screw with differential thread**



HFS radial clamping system

Head change is quick, easy and always in the machine



- 6 Eccentric pin**
for rapid clamping and release with high clamping force
- 7 Taper for easy, highly accurate centring**
- 8 Face connection for rigidity and stability**
- 9 Internal coolant supply**
Exit directly at the cutting edge
- 10 Precision pull stud**
- 11 Different holder variants**
e.g. cylindrical shank, HSK-A



Product ID codes

HFS replaceable head holders

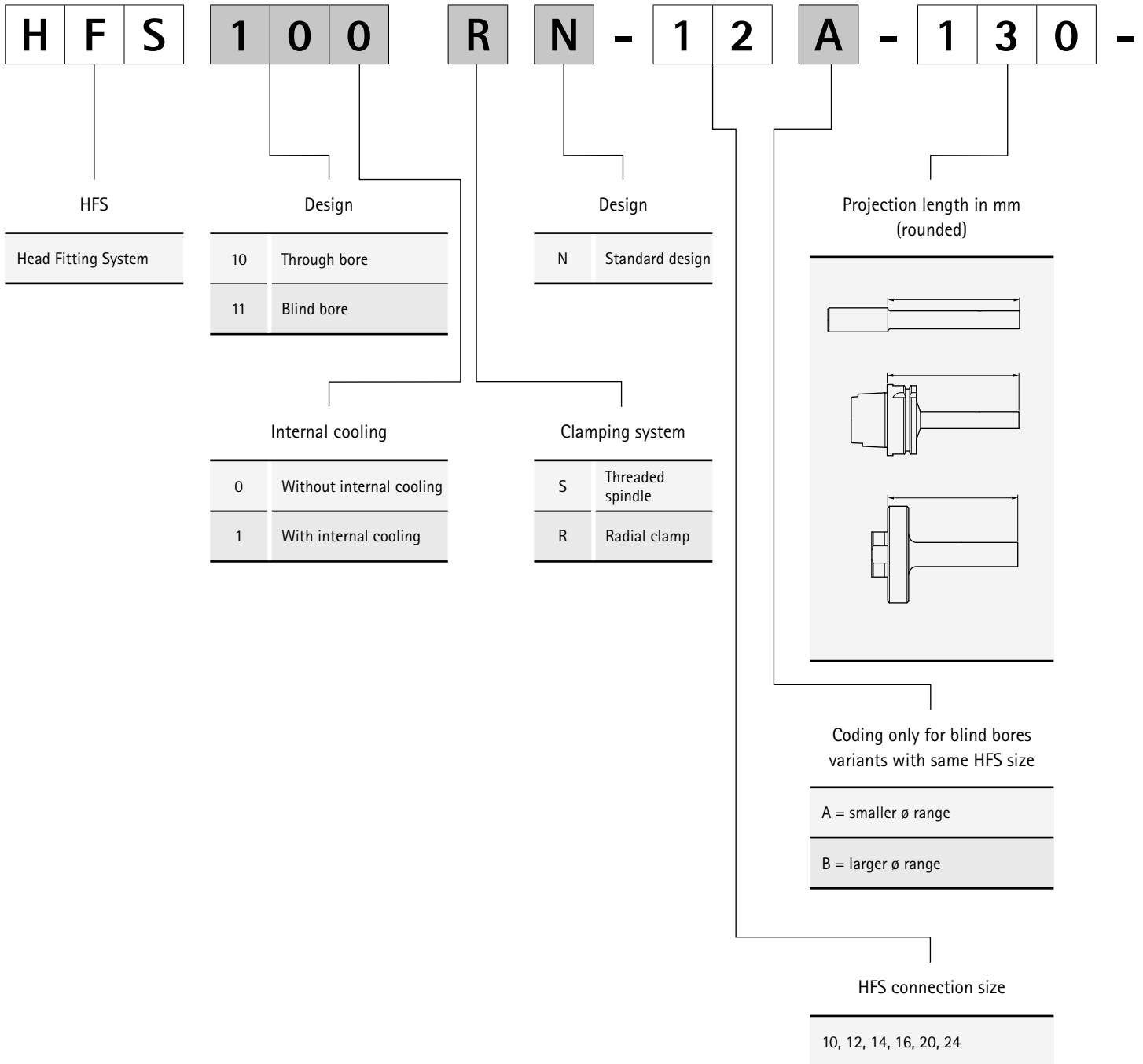

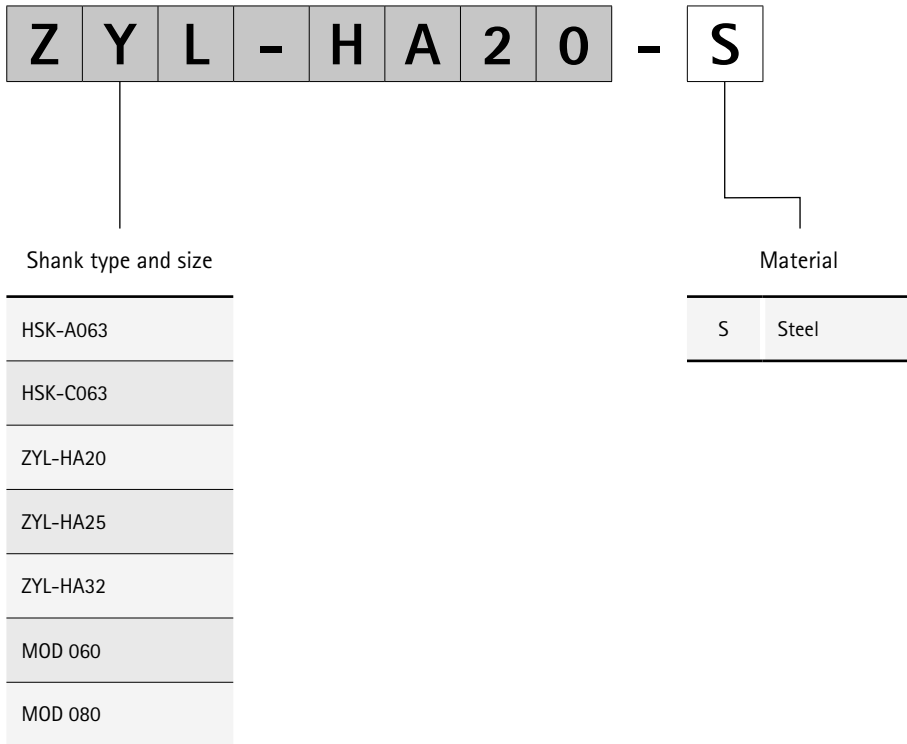

HFS replaceable head holders

With axial clamping system

Shank to MN 623, similar to DIN 1835-A

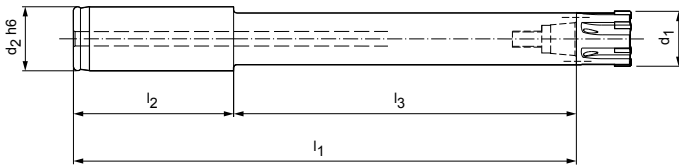

Long design with cylindrical shank

Dimensions						Specification	Order no.
d_1	HFS size	d_2 h6	l_1	l_2	l_3		
15,60 - 18,59	10	20	160	50	110	HFS101SN-10-110-ZYL-HA20-S	30010248
18,60 - 21,29	12	20	179,5	50	129,5	HFS101SN-12-130-ZYL-HA20-S	30010249
21,30 - 23,99	14	20	180,5	50	130,5	HFS101SN-14-131-ZYL-HA20-S	30010250
24,00 - 29,99	16	25	211	60	151	HFS101SN-16-151-ZYL-HA25-S	30010251
30,00 - 39,99	20	25	210	60	150	HFS101SN-20-150-ZYL-HA25-S	30010252
40,00 - 50,70	24	32	266	60	206	HFS101SN-24-206-ZYL-HA32-S	30010253
50,71 - 65,00							

Short design with cylindrical shank

Dimensions						Specification	Order no.
d_1	HFS size	d_2 h6	l_1	l_2	l_3		
15,60 - 18,59	10	20	99	50	49	HFS101SN-10-049-ZYL-HA20-S	30010256
18,60 - 21,29	12	20	118,5	50	68,5	HFS101SN-12-069-ZYL-HA20-S	30010257
21,30 - 23,99	14	20	119,5	50	69,5	HFS101SN-14-070-ZYL-HA20-S	30010258
24,00 - 29,99	16	25	150	60	90	HFS101SN-16-090-ZYL-HA25-S	30010259
30,00 - 39,99	20	25	149	60	89	HFS101SN-20-089-ZYL-HA25-S	30010260
40,00 - 50,70	24	32	167	60	107	HFS101SN-24-107-ZYL-HA32-S	30010261
50,71 - 65,00							

Ultra-short design with cylindrical shank

Dimensions						Specification	Order no.
d_1	HFS size	d_2 h6	l_1	l_2	l_3		
18,60 - 21,29	12	20	82	50	32	HFS101SN-12-032-ZYL-HA20-S	30078683

Dimensions in mm.

Scope of delivery: Tool holder with threaded spindle and hexagonal T-handle.

HFS replaceable head holders

With axial clamping system

Shank to MN 623, similar to DIN 1835-A

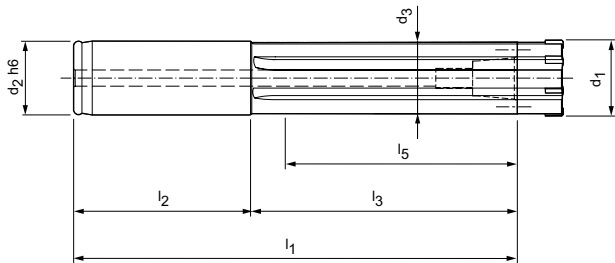

Long design with cylindrical shank

Dimensions								Specification	Order no.
d_1	HFS size	d_2 h6	d_3	l_1	l_2	l_3	l_5		
16,60 - 19,39	10	20	16	160	50	110	94	HFS111SN-10A-110-ZYL-HA20-S	30026380
19,40 - 21,29	10	20	18,6	160	50	110	94	HFS111SN-10B-110-ZYL-HA20-S	30026488
21,30 - 24,99	12	20	20,5	180,5	50	130,5	114,5	HFS111SN-12-131-ZYL-HA20-S	30026489
25,00 - 28,99	14	25	24,2	211,5	60	151,5	132,5	HFS111SN-14-152-ZYL-HA25-S	30026510
29,00 - 32,29	16	25	28,2	210	60	150	131	HFS111SN-16A-150-ZYL-HA25-S	30026511
32,30 - 36,99	16	25	31,5	210	60	150	140	HFS111SN-16B-150-ZYL-HA25-S	30026512
37,00 - 41,19	20	25	36,2	210	60	150	140	HFS111SN-20A-150-ZYL-HA25-S	30026513
41,20 - 44,99	20	25	40,2	210	60	150	140	HFS111SN-20B-150-ZYL-HA25-S	30026514
45,00 - 50,70	24	32	44	266	60	206	195	HFS111SN-24-206-ZYL-HA32-S	30026515
50,71 - 65,00									

Short design with cylindrical shank

Dimensions								Specification	Order no.
d_1	HFS size	d_2 h6	d_3	l_1	l_2	l_3	l_5		
16,60 - 19,39	10	20	16	99	50	49	33	HFS111SN-10A-049-ZYL-HA20-S	30026516
19,40 - 21,29	10	20	18,6	99	50	49	33	HFS111SN-10B-049-ZYL-HA20-S	30026521
21,30 - 24,99	12	20	20,5	117,5	50	67,5	51,5	HFS111SN-12-068-ZYL-HA20-S	30026522
25,00 - 28,99	14	25	24,2	150,5	60	90,5	71,5	HFS111SN-14-091-ZYL-HA25-S	30026523
29,00 - 32,29	16	25	28,2	149	60	89	70	HFS111SN-16A-089-ZYL-HA25-S	30026525
32,30 - 36,99	16	25	31,5	149	60	89	79	HFS111SN-16B-089-ZYL-HA25-S	30026526
37,00 - 41,19	20	25	36,2	149	60	89	79	HFS111SN-20A-089-ZYL-HA25-S	30026527
41,20 - 44,99	20	25	40,2	149	60	89	79	HFS111SN-20B-089-ZYL-HA25-S	30026528
45,00 - 50,70	24	32	44	167	60	107	96	HFS111SN-24-107-ZYL-HA32-S	30026529
50,71 - 65,00									

Dimensions in mm.

Scope of delivery: Tool holder with threaded spindle and hexagonal T-handle.

HFS replaceable head holders

With axial clamping system with radial and angular alignment
Module connection sizes to MN 5000-14

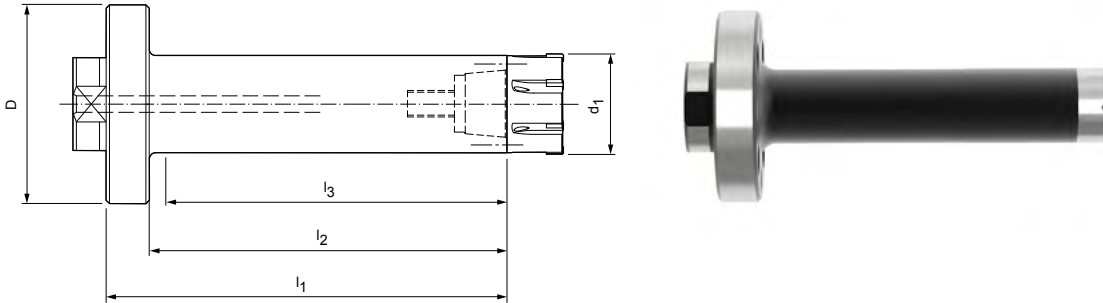

Long design with module adaptor (radial and angular alignment)

Dimensions						Specification	Order no.
d ₁	HFS size	D	l ₁	l ₂	l ₃		
15,60 - 18,59	10	60	81	68	61	HFS101SN-10-081-MOD-060-S	30010264
18,60 - 21,29	12	60	100,5	87,5	80,5	HFS101SN-12-101-MOD-060-S	30010265
21,30 - 23,99	14	60	101,5	88,5	79,5	HFS101SN-14-102-MOD-060-S	30010266
24,00 - 29,99	16	60	122	109	104	HFS101SN-16-122-MOD-060-S	30010267
30,00 - 39,99	20	60	121	108	103	HFS101SN-20-121-MOD-060-S	30010268
40,00 - 50,70	24	60	133	120	116	HFS101SN-24-133-MOD-060-S	30010269
50,71 - 65,00	24	80	133	116	112	HFS101SN-24-133-MOD-080-S	30190195



List of spare parts for module adaptors

Module size D	Cylinder screw ISO 4762 (DIN 912)			Thrust pad		Threaded pin	
	Quantity required	Size	Order no.	Size	Order no.	Size	Order no.
60	4	M5x16-12,9	10003601	10,6x5	10040108	M8x1x8	10040109
80	4	M6x20-12,9	10003619	10,6x5	10040108	M8x1x11,5	10075074

Dimensions in mm.

Scope of delivery: Tool holder with threaded spindle, screwdriver with T-handle, fastening screws for the module adaptor, and parts for the angular alignment of the module adaptor.

HFS replaceable head holders

With axial clamping system with radial and angular alignment
Module connection sizes to MN 5000-14

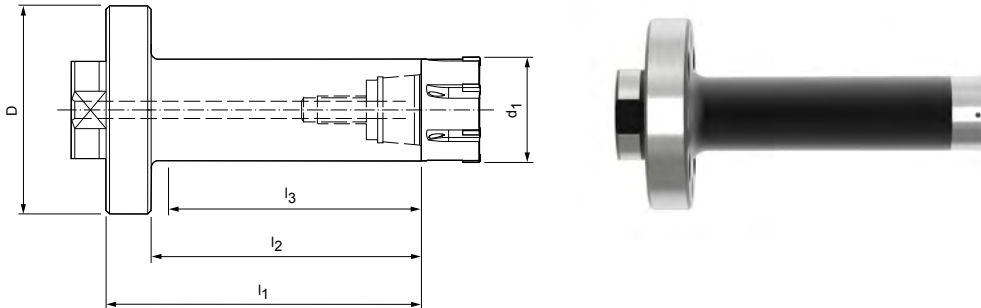

Short design with module adaptor (radial and angular alignment)

Dimensions						Specification	Order no.
d ₁	HFS size	D	l ₁	l ₂	l ₃		
15,60 - 18,59	10	60	49	36	31	HFS101SN-10-049-MOD-060-S	30027896
18,60 - 21,29	12	60	58,5	45,5	40,5	HFS101SN-12-059-MOD-060-S	30027897
21,30 - 23,99	14	60	62,5	49,5	44,5	HFS101SN-14-063-MOD-060-S	30027898
24,00 - 29,99	16	60	72	59	54	HFS101SN-16-072-MOD-060-S	30027899
30,00 - 39,99	20	60	71	58	53	HFS101SN-20-071-MOD-060-S	30027900
40,00 - 50,70	24	60	84	71	66	HFS101SN-24-084-MOD-060-S	30027901
50,71 - 65,00	24	80	84	67	62	HFS101SN-24-084-MOD-080-S	30152510



List of spare parts for module adaptors

Module size D	Cylinder screw ISO 4762 (DIN 912)			Thrust pad		Threaded pin	
	Quantity required	Size	Order no.	Size	Order no.	Size	Order no.
60	4	M5x16-12,9	10003601	10,6x5	10040108	M8x1x8	10040109
80	4	M6x20-12,9	10003619	10,6x5	10040108	M8x1x11,5	10075074

Dimensions in mm.

Scope of delivery: Tool holder with threaded spindle, screwdriver with T-handle, fastening screws for the module adaptor, and parts for the angular alignment of the module adaptor.

HFS replaceable head holders

With axial clamping system with radial and angular alignment
Module connection sizes to MN 5000-14

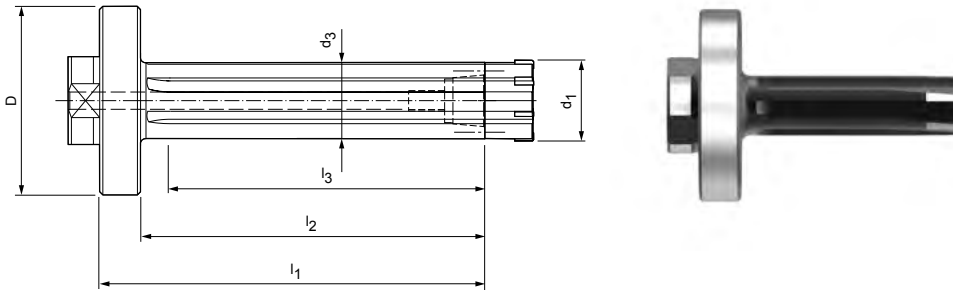

Long design with module adaptor (radial and angular alignment)

Dimensions							Specification	Order no.
d ₁	HFS size	D	d ₃	l ₁	l ₂	l ₃		
16,60 - 19,39	10	60	16	81	68	48	HFS111SN-10A-081-MOD-060-S	30026562
19,40 - 21,29	10	60	18,6	81	68	48	HFS111SN-10B-081-MOD-060-S	30026563
21,30 - 24,99	12	60	20,5	101,5	88,5	69,5	HFS111SN-12-102-MOD-060-S	30026564
25,00 - 28,99	14	60	24,2	122,5	109,5	90,5	HFS111SN-14-123-MOD-060-S	30026565
29,00 - 32,29	16	60	28,2	121	108	89	HFS111SN-16A-121-MOD-060-S	30026566
32,30 - 36,99	16	60	31,5	121	108	89	HFS111SN-16B-121-MOD-060-S	30026567
37,00 - 41,19	20	60	36,2	121	108	89	HFS111SN-20A-121-MOD-060-S	30026568
41,20 - 44,99	20	60	40,2	121	108	89	HFS111SN-20B-121-MOD-060-S	30026569
45,00 - 50,70	24	60	44	123	110	95	HFS111SN-24-123-MOD-060-S	30026570
50,71 - 65,00	24	80	44	133	116	110	HFS111SN-24-133-MOD-080-S	30193167



List of spare parts for module adaptors

Module size D	Cylinder screw ISO 4762 (DIN 912)			Thrust pad		Threaded pin	
	Quantity required	Size	Order no.	Size	Order no.	Size	Order no.
60	4	M5x16-12,9	10003601	10,6x5	10040108	M8x1x8	10040109
80	4	M6x20-12,9	10003619	10,6x5	10040108	M8x1x11,5	10075074

Dimensions in mm.

Scope of delivery: Tool holder with threaded spindle, screwdriver with T-handle, fastening screws for the module adaptor, and parts for the angular alignment of the module adaptor.

HFS replaceable head holders

With axial clamping system with radial and angular alignment
Module connection sizes to MN 5000-14

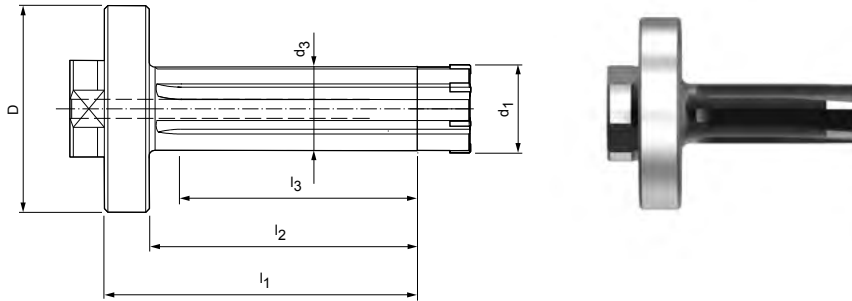

Short design with module adaptor (radial and angular alignment)

Dimensions							Specification	Order no.
d ₁	HFS size	D	d ₃	l ₁	l ₂	l ₃		
16,60 - 19,39	10	60	16	49	36	31	HFS111SN-10A-049-MOD-060-S	30027885
19,40 - 21,29	10	60	18,6	59	46	41	HFS111SN-10B-059-MOD-060-S	30027886
21,30 - 24,99	12	60	20,5	62,5	49,5	44,5	HFS111SN-12-063-MOD-060-S	30027887
25,00 - 28,99	14	60	24,2	72,5	59,5	54,5	HFS111SN-14-073-MOD-060-S	30027888
29,00 - 32,29	16	60	28,2	71	58	53	HFS111SN-16A-071-MOD-060-S	30027889
32,30 - 36,99	16	60	31,5	71	58	53	HFS111SN-16B-071-MOD-060-S	30027890
37,00 - 41,19	20	60	36,2	71	58	53	HFS111SN-20A-071-MOD-060-S	30027891
41,20 - 44,99	20	60	40,2	81	68	63	HFS111SN-20B-081-MOD-060-S	30027892
45,00 - 50,70	24	60	44	84	71	66	HFS111SN-24-084-MOD-060-S	30027893
50,71 - 65,00	24	80	44	84	67	64	HFS111SN-24-084-MOD-080-S	30193168



List of spare parts for module adaptors

Module size D	Cylinder screw ISO 4762 (DIN 912)			Thrust pad		Threaded pin	
	Quantity required	Size	Order no.	Size	Order no.	Size	Order no.
60	4	M5x16-12,9	10003601	10,6x5	10040108	M8x1x8	10040109
80	4	M6x20-12,9	10003619	10,6x5	10040108	M8x1x11,5	10075074

Dimensions in mm.

Scope of delivery: Tool holder with threaded spindle, screwdriver with T-handle, fastening screws for the module adaptor, and parts for the angular alignment of the module adaptor.

HFS replaceable head holders

With axial clamping system

Shank hollow shank taper-A according to DIN 69893-1

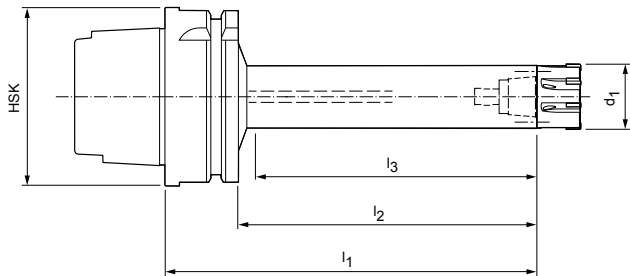

Long design with HSK-A 63

Dimensions						Specification	Order no.
d_1	HFS size	l_1	l_2	l_3	HSK-A size		
15,60 - 18,59	10	117	91	86	63	HFS101SN-10-117-HSK-A063-S	30010272
18,60 - 21,29	12	132,5	106,5	100,5	63	HFS101SN-12-133-HSK-A063-S	30010273
21,30 - 23,99	14	131,5	105,5	99,5	63	HFS101SN-14-132-HSK-A063-S	30010275
24,00 - 29,99	16	163	137	129	63	HFS101SN-16-163-HSK-A063-S	30010276
30,00 - 39,99	20	188	162	158	63	HFS101SN-20-188-HSK-A063-S	30010280
40,00 - 50,70	24	207	181	176	63	HFS101SN-24-207-HSK-A063-S	30010286
50,71 - 65,00							

Short design with HSK-A 63

Dimensions						Specification	Order no.
d_1	HFS size	l_1	l_2	l_3	HSK-A size		
15,60 - 18,59	10	77	51	46	63	HFS101SN-10-077-HSK-A063-S	30010283
18,60 - 21,29	12	92,5	66,5	60,5	63	HFS101SN-12-093-HSK-A063-S	30010285
21,30 - 23,99	14	91,5	65,5	59,5	63	HFS101SN-14-092-HSK-A063-S	30010287
24,00 - 29,99	16	112	86	79	63	HFS101SN-16-112-HSK-A063-S	30010288
30,00 - 39,99	20	111	85	78	63	HFS101SN-20-111-HSK-A063-S	30010289
40,00 - 50,70	24	109	83	76	63	HFS101SN-24-109-HSK-A063-S	30010291
50,71 - 65,00							

Dimensions in mm.

Scope of delivery: Tool holder with threaded spindle and hexagonal T-handle.

HFS replaceable head holders

With axial clamping system

Shank hollow shank taper-A according to DIN 69893-1

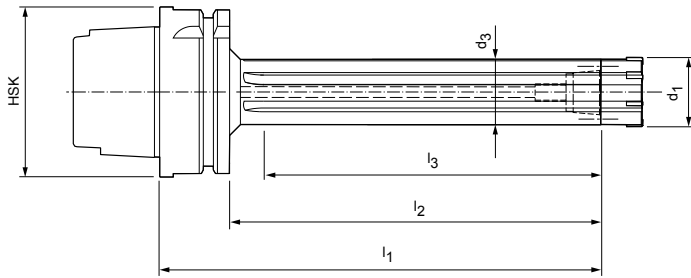

Long design with HSK-A 63

Dimensions							Specification	Order no.
d ₁	HFS size	d ₃	l ₁	l ₂	l ₃	HSK-A size		
16,60 - 19,39	10	16,0	117	91	71	63	HFS111SN-10A-117-HSK-A063-S	30026586
19,40 - 21,29	10	18,6	117	91	71	63	HFS111SN-10B-117-HSK-A063-S	30026587
21,30 - 24,99	12	20,5	131,5	105,5	86,5	63	HFS111SN-12-132-HSK-A063-S	30026588
25,00 - 28,99	14	24,2	163,5	137,5	118,5	63	HFS111SN-14-164-HSK-A063-S	30026589
29,00 - 32,29	16	28,2	188	162	143	63	HFS111SN-16A-188-HSK-A063-S	30026590
32,30 - 36,99	16	31,5	188	162	143	63	HFS111SN-16B-188-HSK-A063-S	30026591
37,00 - 41,19	20	36,2	188	162	152	63	HFS111SN-20A-188-HSK-A063-S	30026592
41,20 - 44,99	20	40,2	188	162	152	63	HFS111SN-20B-188-HSK-A063-S	30026593
45,00 - 50,70	24	44,0	233	207	197	63	HFS111SN-24-233-HSK-A063-S	30026594
50,71 - 65,00								

Short design with HSK-A 63

Dimensions							Specification	Order no.
d ₁	HFS size	d ₃	l ₁	l ₂	l ₃	HSK-A size		
16,60 - 19,39	10	16,0	77	51	31	63	HFS111SN-10A-077-HSK-A063-S	30026574
19,40 - 21,29	10	18,6	77	51	31	63	HFS111SN-10B-077-HSK-A063-S	30026575
21,30 - 24,99	12	20,5	91,5	65,5	46,5	63	HFS111SN-12-092-HSK-A063-S	30026576
25,00 - 28,99	14	24,2	112,5	86,5	67,5	63	HFS111SN-14-113-HSK-A063-S	30026577
29,00 - 32,29	16	28,2	111	85	66	63	HFS111SN-16A-111-HSK-A063-S	30026578
32,30 - 36,99	16	31,5	111	85	66	63	HFS111SN-16B-111-HSK-A063-S	30026579
37,00 - 41,19	20	36,2	111	85	75	63	HFS111SN-20A-111-HSK-A063-S	30026580
41,20 - 44,99	20	40,2	111	85	75	63	HFS111SN-20B-111-HSK-A063-S	30026581
45,00 - 50,70	24	44,0	109	83	73	63	HFS111SN-24-109-HSK-A063-S	30026582
50,71 - 65,00								

Dimensions in mm.

Scope of delivery: Tool holder with threaded spindle and hexagonal T-handle.

HFS replaceable head holders

With radial clamping system, shank to MN 623, similar to DIN 1835-A
For HPR replaceable head reamer HPR100, HPR110, HPR200, HPR210

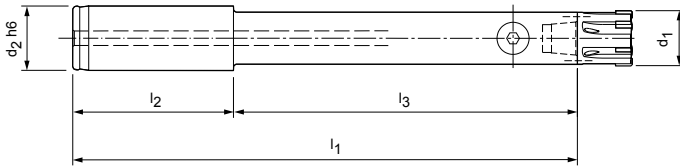

Long design with cylindrical shank

Dimensions						Specification	Order no.
d_1	HFS size	d_2 h6	l_1	l_2	l_3		
18,60 - 21,29	12	20	179,5	50	129,5	HFS101RN-12-130-ZYL-HA20-S	30078110
21,30 - 23,99	14	20	180,5	50	130,5	HFS101RN-14-131-ZYL-HA20-S	30078115
24,00 - 29,99	16	25	211	60	151	HFS101RN-16-151-ZYL-HA25-S	30078116
30,00 - 39,99	20	25	210	60	150	HFS101RN-20-150-ZYL-HA25-S	30080112

Short design with cylindrical shank

Dimensions						Specification	Order no.
d_1	HFS size	d_2 h6	l_1	l_2	l_3		
18,60 - 21,29	12	20	118,5	50	68,5	HFS101RN-12-069-ZYL-HA20-S	30078117
21,30 - 23,99	14	20	119,5	50	69,5	HFS101RN-14-070-ZYL-HA20-S	30078118
24,00 - 29,99	16	25	150	60	90	HFS101RN-16-090-ZYL-HA25-S	30078119
30,00 - 39,99	20	25	149	60	89	HFS101RN-20-089-ZYL-HA25-S	30080151

Ultra-short design with cylindrical shank

Dimensions						Specification	Order no.
d_1	HFS size	d_2 h6	l_1	l_2	l_3		
18,60 - 21,29	12	20	85	50	35	HFS101RN-12-035-ZYL-HA20-S	30115560

Dimensions in mm.

Recommendation: To make it possible to change reamers quickly using the radial clamping system, at least 1 additional pull stud should be ordered.

Scope of delivery: Tool holder with pull stud, hexagonal T-handle and open-ended wrench for pull stud.



Accessories and spare parts for HFS



Threaded spindle for axial clamping system

HFS size	without coolant through-bore Threaded spindle MN 618 Order no.	with coolant through-bore Threaded spindle MN 618 Order no.
10	10024720	10025194
12	10024721	10025195
14	10024721	10025195
16	10024722	10025196
20	10024722	10025196
24	10024723	10025198



Pull studs for radial clamping system

HFS size	without coolant bore Order no.	with coolant bore Order no.
12	10059113	10059273
14	10059113	10059273
16	10059117	10059279
20	10059117	10059279

Recommendation: To make it possible to change reamers quickly using the radial clamping system, at least 1 additional pull stud should be ordered.

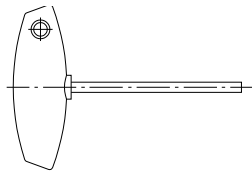

Hexagonal wrench with T-handle

HFS size	Short design		Long design	
	Size	Order no.	Size	Order no.
10	sw2,5 x 100	10006233	sw2,5 x 200	10032722
12	sw3 x 100	10006234	sw3 x 200	10025313
14	sw3 x 100	10006234	sw3 x 200	10025313
16	sw4 x 100	10006235	sw4 x 200	10018010
20	sw4 x 100	10006235	sw4 x 200	10018010
24	sw5 x 100	10006236	sw5 x 200	10013349



Taper wipers for HFS internal tapers

HFS size	Order no.
10	10029989
12	10029990
14	10030002
16	10030003
20	10030004
24	10030005

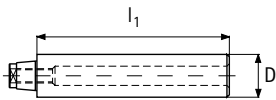

Test arbor (alignment aid)

HFS size	l_1	D	Order no.
10	70	15	30036468
12	80	20	30036469
14	80	20,5	30036470
16	80	23,2	30036471
20	80	29,3	30036472
24	80	39	30036473

Dimensions in mm.

Design: Permissible run-out variation of the cylindrical part in relation to the HFS connection of max. 0.002 mm.

Accessories and spare parts for HSK-A 63

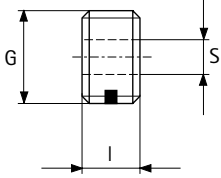

Blind screw

HSK-A size	I	S	G	Order no.
63	11,5	8	M18x1	30326078

HFS size	sw	Torque wrench				Blades and hexagonal inserts for torque wrenches			
		Torque	Design	Input	Order no.	l [mm]	l ₁ [mm]	Input	Order no.
10	2.5	4 Nm	fixed – with blade	–	10044842	175	70	Blade	10044839
12	3	6 Nm	adjustable – without element	1/4"	10040125	55	30	1/4" element	10040122
14	3	6 Nm	adjustable – without element	1/4"	10040125	55	30	1/4" element	10040122
16	4	15 Nm	adjustable – without element	3/8"	10040126	60	35	3/8" element	10040123
20	4	15 Nm	adjustable – without element	3/8"	10040126	60	35	3/8" element	10040123
24	5	20 Nm	adjustable – without element	3/8"	10040126	70	45	3/8" element	10040124

Torque wrench and hexagon inserts only from HFS size 12 or sw 3.

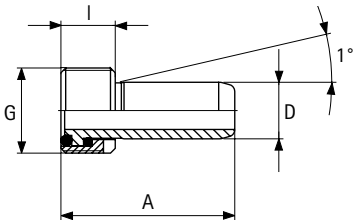

Coolant tube

HSK-A size	A	I	G	D	Order no.
63	36.6	11,5	M18x1	12	30326006

Scope of delivery: Coolant tube with two O-rings and clamping nut.
 Design: Smooth angular movement 1° self-centering, axially sealed.
 Note: Designed according to DIN 69893.

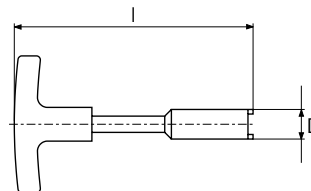

Assembly tool

HSK-A size	I	D	Order no.
63	182	17	10040110

Use: For installation and removal of coolant tubes.

Dimensions in mm.

Use: For closing the thread bore in hollow shank taper tool shanks if no coolant tube is used.

Design: With Nylok insert for screw retention.

Workpiece material: Corrosion-resistant steel.



TOOLS WITH GUIDE PADS

Tools with guide pads

Article overview – single bladed reamers	478
Product ID codes	480

WP single-bladed reamers

MN2000	484
MN2003	486
MN2004	488
MN2034	489
MN2023	490
MN2024	491
MN2043	492
MN2044	493
Indexable insert leads AS AZ DZ EK SZ 	494
Cutting data	504

EasyAdjust system

Product overview, handling and system overview	514
Back taper	516
Article overview	517
HX blades for EA system	518
TEC indexable inserts for EA system	520
Accessories	522
Cutting data	524

External machining tools

Product overview, handling and system overview	538
TEC indexable inserts	540
Indexable inserts	542
Accessories	544
Cutting data	546

Technical appendix

Instructions for use	737
----------------------------	-----



Article overview – single bladed reamers

Machine concept		Type of coolant supply		Type of bore		Number of cutting edges	Shank form
Single bladed reamers	Boring machines		✓	✓		1	Morse taper shank
Single bladed reamers	Automated lathes (with floating holder)	✓		✓		1	Cylindrical shank with clamping surface
		✓			✓	1	
		✓			✓	1	
Single bladed reamers	Machining centres	✓		✓		1	Cylindrical shank with NC clamping surface
		✓			✓	1	
		✓		✓		1	Cylindrical shank smooth
		✓			✓	1	

Leads for MAPAL indexable inserts

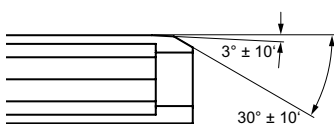

AS lead

Lead suitable for all materials, high surface quality even at high cutting speeds. Lead length 1.3 mm.

Max. cutting depth: 0.25 mm
Rake angle: 0°, 6°, 12°

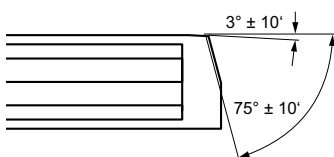

AZ lead

For high cutting speeds; especially suitable for aluminium machining.



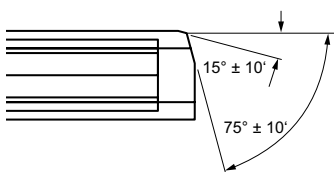







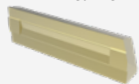
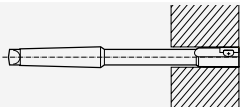

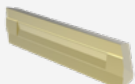
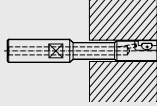

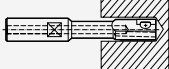

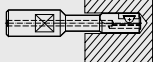
Max. cutting depth: 0.5 mm
Rake angle: 0°, 6°, 12°

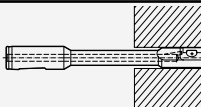

DZ lead

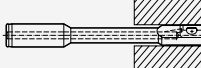
Especially for short chipping materials (grey cast iron) and large cutting depths. The 15° lead angle of the finishing edge slightly increases the radial forces, making it suitable for thin-walled workpieces as well.

Max. cutting depth: 0.15 mm
Rake angle: 0°, 6°, 12°

Tool	Cutting edge		Page	Series
Series	Description			
MN2000	WP reamer 		484	MN2000 Design with MK shank 
MN2003	WP reamer 		486	MN2003 Short design with internal coolant supply 
MN2004			488	MN2004 Short design 
MN2034 (short design)			489	MN2034 Extra short design 
MN2023	WP NC reamer 		490	MN2023 NC-form 
MN2024			491	MN2024 NC-form 
MN2043			492	MN2043 NC-form 
MN2044			493	MN2044 NC-form 

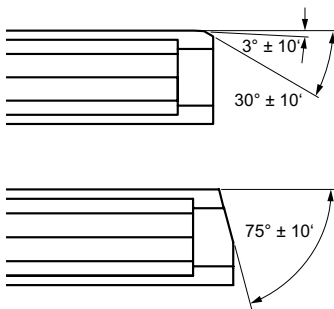

EK lead

Only use if a small lead length of 0.6 mm is required, for all work-piece material, do not exceed max. feed rate of 0.2 mm/rev.

Max. cutting depth: 0.15 mm
 Rake angle: 0 °, 6 °, 12 °

SZ lead

Especially for aluminium cast alloys, good surface at small feed rates. Gauges are met exactly. The lead angle of the main cutter of 75° reduces the radial forces, making it particularly suitable for thin-walled workpieces.

Max. cutting depth: 1.0 mm
 Rake angle: 6 °, 12 °

Product ID codes

WP reamer

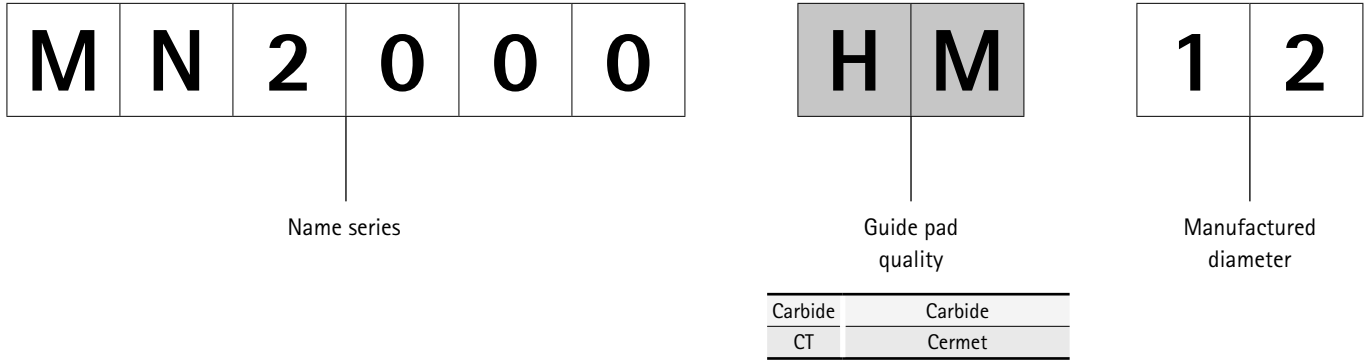

EasyAdjust system

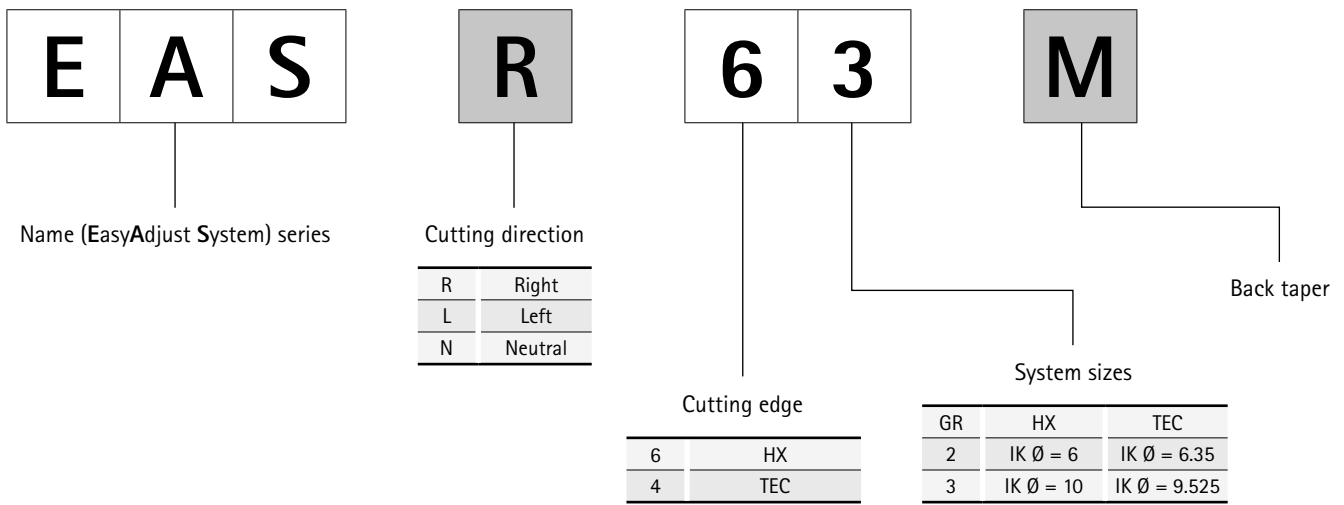

H	7
---	---

IT tolerance
or dimensions

A	S
---	---

Lead
designation

AS	Application infor- mation on page 478/479
AZ	
DZ	
EK	
SZ	

Product ID codes

Indexable inserts



Size
81 | 90 | 91 | 92 | 93
Select the size to suit the design of the reamer. For assignment, see product tables.

Only state for designs with guiding chamfer.

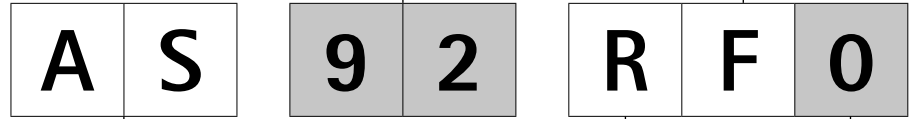

Lead form
AS = 3°/30° length 1.3 mm
AZ = 3°/75° length 1.3 mm
DZ = 15°/75° length 0.55 mm
EK = 3°/30° length 0.6 mm
SZ = 0°/75° length 0.55 mm

Cutting direction
R = right-hand cutting
L = left-hand cutting

Size of the rake angle
0 = 0°
6 = 6°
2 = 12°

HX indexable inserts

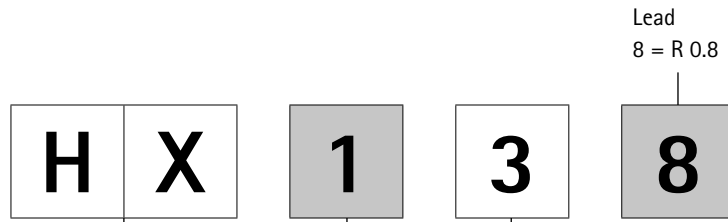

Hexagonal geometry Hexagonal

Chip form geometry (rake angle)
1 = Highly positive
2 = Positive

Indexable insert size
2 = incircle Ø 6 mm
3 = incircle Ø 10 mm

Lead
8 = R 0.8

TEC indexable inserts

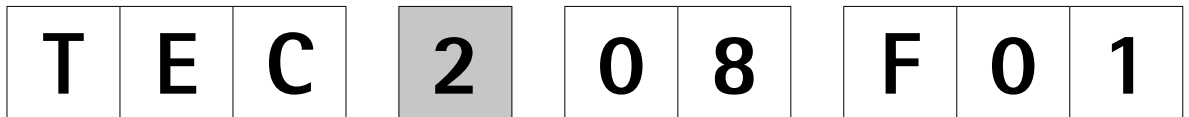

Blade form (Tetragonal)

Indexable insert size
2 = incircle Ø: 6.35
3 = incircle Ø: 9.525

Lead form
04 = R = 0.4
08 = R = 0.8
AS = 3°/30° length 1.3
EK = 3°/30° length 0.6
DZ = 15°/75° length 0.55

Cutting edge design
F01 = sharp-edged
02 = rounded
S35 = Negative chamfer and rounded

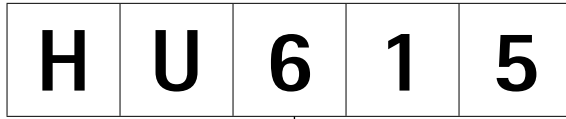

Cutting material quality
e.g.: HU = carbide, uncoated



Cutting direction
RL = right and left-hand cutting



Cutting material quality
e.g.: HU = carbide, uncoated

Optional:
Guiding chamfer



Cutting direction
R = right-hand cutting
L = left-hand cutting
N = Right-/left-hand cutting (neutral)

Chip groove – 1st element (position)
0 = without characteristic
1 = parallel positive

Chip groove – 2nd element (rake angle)
A = 0° N = 12°
G = 6° U = 18°
J = 8°

Only with cutting edge tipping
F = Entire rake face on one side (full chamfer)

Cutting material quality (example)



WP single bladed reamer MN2000

Design with MK shank

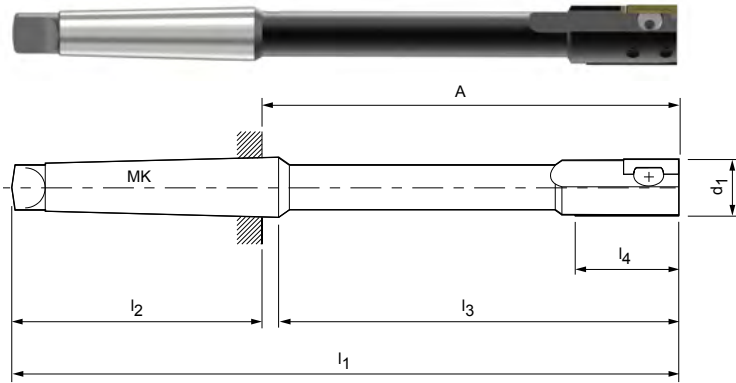

Dimensions							Indexable insert size	Accessories				
d ₁ *	l ₁	l ₂	l ₃	l ₄	MK	A		Clamping		Adjusting		
								Torx screw/threaded spindle	Clamping plate	Threaded pin MN 620	Adjusting wedge MN 619	
								Order no. (size)				
5,00 - 5,29	126**	62	60,5	15	1	64	(SP) 81	Torx screw	10036776 (M1,6x3,9)	30026285 (GR - 1YN)	10036736 (M2x1,8)	30026239 (GR - 06)
5,30 - 5,49	126**	62	60,5	15	1	64	(SP) 81		10036778 (M1,6x4,4)	30026285 (GR - 1YN)	10036737 (M2x2)	30026239 (GR - 06)
5,50 - 6,19	126**	62	60,5	15	1	64	(SP) 81		10036780 (M2x4)	30026286 (GR - 1X)	10036737 (M2x2)	30026260 (GR - 07)
6,20 - 6,90	126**	62	60,5	15	1	64	(SP) 81		10036781 (M2x5)	30026286 (GR - 1X)	10036738 (M2x2,5)	30026260 (GR - 07)
6,91 - 7,49	136**	62	70,5	15	1	74	90		10036783 (M2,5x4,8)	30026287 (GR - 1W)	10036730 (M2,5x2,2)	30026261 (GR - 08)
7,50 - 7,79	136**	62	70,5	15	1	74	90		10036784 (M2,5x5,2)	30026287 (GR - 1W)	10036731 (M2,5x2,5)	30026262 (GR - 09)
7,80 - 7,99	155	62	89,5	30	1	93	90		10036711 (M3LH/RHx5)	30026288 (GR - 0F)	10036743 (M3x2,5)	30026238 (GR - 0)
8,00 - 8,79	155	62	89,5	30	1	93	90		10036711 (M3LH/RHx5)	30026288 (GR - 0F)	10036743 (M3x2,5)	30026238 (GR - 0)
8,80 - 9,29	160	62	94,5	30	1	98	90		10036722 (M3LH/RHx6)	30026289 (GR - 0N)	10036744 (M3x3)	30026238 (GR - 0)
9,30 - 9,79	170	62	104,5	30	1	108	91	10036722 (M3LH/RHx6)	30026292 (GR - 1N)	10036744 (M3x3)	30026238 (GR - 0)	
9,80 - 11,29	170	62	104,5	30	1	108	91	10036722 (M3LH/RHx6)	30026292 (GR - 1N)	10036744 (M3x3)	30026263 (GR - 1)	
11,30 - 11,79	170	62	104,5	30	1	108	92	10036724 (M4x0,5LH/RHx6,5)	30026294 (GR - 2F)	10036751 (M4x3)	30026266 (GR - 2)	
11,80 - 12,29	170	62	104,5	30	1	108	92	10036724 (M4x0,5LH/RHx6,5)	30026294 (GR - 2F)	10036751 (M4x3)	30026266 (GR - 2)	
12,30 - 13,29	180	62	114,5	30	1	118	92	10036724 (M4x0,5LH/RHx6,5)	30026294 (GR - 2F)	10036752 (M4x4)	30026266 (GR - 2)	
13,30 - 14,29	180	62	114,5	30	1	118	92	10036725 (M4x0,5LH/RHx9)	30026296 (GR - 2N)	10036753 (M4x5)	30026266 (GR - 2)	
14,30 - 15,29	180	62	114,5	30	1	118	92	10036725 (M4x0,5LH/RHx9)	30026296 (GR - 2N)	10036753 (M4x5)	30026266 (GR - 2)	
15,30 - 16,29	200	75	120	30	2	125	92	10036725 (M4x0,5LH/RHx9)	30026296 (GR - 2N)	10036753 (M4x5)	30026266 (GR - 2)	
16,30 - 18,29	210	75	130	30	2	135	92	10036725 (M4x0,5LH/RHx9)	30026296 (GR - 2N)	10036753 (M4x5)	30026266 (GR - 2)	
18,30 - 20,29	220	75	140	30	2	145	92	10036725 (M4x0,5LH/RHx9)	30026296 (GR - 2N)	10036755 (M4x8)	30026266 (GR - 2)	

Ordering example (see P. 480): MN2000 HM 11.8 H7 AS

Dimensions in mm.

Additional dimensions available upon request.

SP = indexable blade, not reversible.

Adjustment instructions and installation of the accessories, see technical appendix.

* Values indicate the sizes for different diameters (adjustable only within a tolerance field), not the adjustment range.

** With 2.5 mm long centring pin for d₁ smaller than 7.8 mm.

Please indicate the desired guide pad quality (HM, cermet) when ordering.

Unless otherwise indicated, the guide pads will be delivered in HM quality.

Tools with guide pads in PCD quality available from Ø 8 mm.

Reconditioning possible from Ø 8.00 for technical reasons.

Price and delivery time for tools with guide pads in PCD quality on request.

For suitable indexable insert, see chapter indexable inserts from page 494.

WP single bladed reamer MN2003

Short design with internal cooling

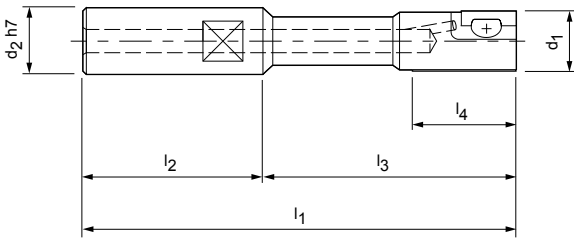

Dimensions							Accessories				
d ₁ *	d ₂ H7	l ₁	l ₂	l ₃	l ₄	Indexable insert size	Clamping		Adjusting		
							Torx screw/threaded spindle	Clamping plate	Threaded pin MN 620	Adjusting wedge MN 619	
							Order no. (size)				
5,00 - 5,29	10	90**	30	60	15	(SP) 81	Torx screw	10036776 (M1,6x3,9)	30026285 (GR - 1YN)	10036736 (M2x1,8)	30026239 (GR - 06)
5,30 - 5,49	10	90**	30	60	15	(SP) 81		10036778 (M1,6x4,4)	30026285 (GR - 1YN)	10036737 (M2x2)	30026239 (GR - 06)
5,50 - 6,19	10	90**	30	60	15	(SP) 81		10036780 (M2x4)	30026286 (GR - 1X)	10036737 (M2x2)	30026260 (GR - 07)
6,20 - 6,90	10	90**	30	60	15	(SP) 81		10036781 (M2x5)	30026286 (GR - 1X)	10036738 (M2x2,5)	30026260 (GR - 07)
6,91 - 7,49	10	100**	30	70	15	90		10036783 (M2,5x4,8)	30026287 (GR - 1W)	10036730 (M2,5x2,2)	30026261 (GR - 08)
7,50 - 7,79	10	100**	30	70	15	90		10036784 (M2,5x5,2)	30026287 (GR - 1W)	10036731 (M2,5x2,5)	30026262 (GR - 09)
7,80 - 8,29	16	120	45	75	30	90		10036711 (M3LH/RHx5)	30026288 (GR - 0F)	10036743 (M3x2,5)	30026238 (GR - 0)
8,30 - 8,79	16	120	45	75	30	90		10036711 (M3LH/RHx5)	30026288 (GR - 0F)	10036744 (M3x3)	30026238 (GR - 0)
8,80 - 9,29	16	120	45	75	30	90		10036722 (M3LH/RHx6)	30026289 (GR - 0N)	10036744 (M3x3)	30026238 (GR - 0)
9,30 - 9,79	16	120	45	75	30	91	10036722 (M3LH/RHx6)	30026292 (GR - 1N)	10036744 (M3x3)	30026238 (GR - 0)	
9,80 - 11,29	16	120	45	75	30	91	Threaded spindle MN 618	10036722 (M3LH/RHx6)	30026292 (GR - 1N)	10036744 (M3x3)	30026263 (GR - 1)
11,30 - 11,79	16	120	45	75	30	92		10036724 (M4x0,5LH/RHx6,5)	30026294 (GR - 2F)	10036751 (M4x3)	30026266 (GR - 2)
11,80 - 12,29	16	120	45	75	30	92		10036724 (M4x0,5LH/RHx6,5)	30026294 (GR - 2F)	10036751 (M4x3)	30026266 (GR - 2)
12,30 - 13,29	16	120	45	75	30	92		10036724 (M4x0,5LH/RHx6,5)	30026294 (GR - 2F)	10036752 (M4x4)	30026266 (GR - 2)
13,30 - 14,29	16	120	45	75	30	92		10036725 (M4x0,5LH/RHx9)	30026296 (GR - 2N)	10036753 (M4x8)	30026266 (GR - 2)
14,30 - 18,29	20	130	55	75	30	92		10036725 (M4x0,5LH/RHx9)	30026296 (GR - 2N)	10036753 (M4x8)	30026266 (GR - 2)
18,30 - 19,79	20	130	55	75	30	92		10036725 (M4x0,5LH/RHx9)	30026296 (GR - 3N)	10036755 (M6x15)	30026266 (GR - 4)
19,80 - 20,29	20	150	55	95	30	92		10036725 (M4x0,5LH/RHx9)	30026296 (GR - 3N)	10036755 (M6x15)	30026266 (GR - 4)

WP single bladed reamer MN 2003

Dimensions						Indexable insert size	Accessories				
d ₁ *	d ₂ H7	l ₁	l ₂	l ₃	l ₄		Clamping		Adjusting		
							Torx screw/threaded spindle	Clamping plate	Threaded pin MN 620	Adjusting wedge MN 619	
							Order no. (size)				
20,30 – 26,29	20	150	55	95	30	92	MN 618	10036725 (M4x0,5LH/RHx9)	30026296 (GR - 2N)	10036755 (M4x8)	30026266 (GR - 2)
26,30 – 30,29	25	160	65	95	30	92	MN 618	10036725 (M4x0,5LH/RHx9)	30026296 (GR - 2N)	10036755 (M4x8)	30026266 (GR - 2)

Ordering example (see P. 480):

MN2003 HM 20.99 H7 AS

Dimensions in mm.

Additional dimensions available upon request.

SP = indexable blade, not reversible.

Adjustment instructions and installation of the accessories, see technical appendix.

* Values indicate the sizes for different diameters (adjustable only within a tolerance field), not the adjustment range.

** With 2.5 mm long centring pin for d₁ smaller than 7.8 mm.

Please indicate the desired guide pad quality (HM, cermet) when ordering.

Unless otherwise indicated, the guide pads will be delivered in HM quality.

Tools with guide pads in PCD quality available from Ø 8 mm.

Reconditioning possible from Ø 8.00 for technical reasons.

Price and delivery time for tools with guide pads in PCD quality on request.

For suitable indexable insert, see chapter indexable inserts from page 494.

WP single bladed reamer MN2004

Short design

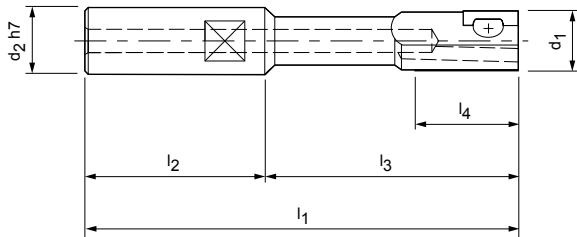

Dimensions							Accessories				
d ₁ *	d ₂ H7	l ₁	l ₂	l ₃	l ₄	Indexable insert size	Clamping		Adjusting		
							Torx screw/threaded spindle	Clamping plate	Threaded pin MN 620	Adjusting wedge MN 619	
							Order no. (size)				
5,90 - 6,29	10	90**	30	60	15	(SP) 81	Torx screw	10036776 (M1,6x3,9)	30026285 (GR - 1YN)	10036737 (M2x2)	30026239 (GR - 06)
6,30 - 6,90	10	90**	30	60	15	(SP) 81		10036778 (M1,6x4,4)	30026285 (GR - 1YN)	10036738 (M2x2,5)	30026239 (GR - 06)
6,91 - 7,29	10	100**	30	70	15	(SP) 81		10036778 (M1,6x4,4)	30026285 (GR - 1YN)	10036738 (M2x2,5)	30026239 (GR - 06)
7,30 - 7,79	10	100**	30	70	15	(SP) 81		10036781 (M2x5)	30026286 (GR - 1X)	10036739 (M2x3)	30026260 (GR - 07)
7,80 - 8,29	16	120**	45	75	15	(SP) 81		10036781 (M2x5)	30026286 (GR - 1X)	10036739 (M2x3)	30026260 (GR - 07)
8,30 - 9,79	16	120	45	75	15	90		10036784 (M2,5x5,2)	30026287 (GR - 1W)	10036732 (M2,5x3)	30026262 (GR - 09)
9,80 - 10,29	16	120	45	75	15	90		10036784 (M2,5x5,2)	30026287 (GR - 1W)	10036733 (M2,5x4)	30026262 (GR - 09)
10,30 - 11,29	16	120	45	75	30	90	Threaded spindle MN 618	10036722 (M3LH/RHx6)	30026289 (GR - 0N)	10036744 (M3x3)	30026263 (GR - 1)
11,30 - 12,29	16	120	45	75	30	90		10036722 (M3LH/RHx6)	30026289 (GR - 0N)	10036745 (M3x4)	30026263 (GR - 1)
12,30 - 14,29	16	120	45	75	30	91		10036722 (M3LH/RHx6)	30026292 (GR - 1N)	10036745 (M3x4)	30026263 (GR - 1)
14,30 - 16,29	20	130	55	75	30	91		10036722 (M3LH/RHx6)	30026292 (GR - 1N)	10036747 (M3x6)	30026263 (GR - 1)
16,30 - 17,29	20	130	55	75	30	92		10036725 (M4x0,5LH/RHx9)	30026296 (GR - 2N)	10036753 (M4x5)	30026266 (GR - 2)
17,30 - 19,79	20	130	55	75	30	92		10036725 (M4x0,5LH/RHx9)	30026296 (GR - 2N)	10036754 (M4x6)	30026266 (GR - 2)
19,80 - 26,29	20	150	55	95	30	92		10036725 (M4x0,5LH/RHx9)	30026296 (GR - 2N)	10036755 (M4x8)	30026266 (GR - 2)
26,30 - 30,29	25	160	65	95	30	92	10036725 (M4x0,5LH/RHx9)	30026296 (GR - 2N)	10036755 (M4x8)	30026266 (GR - 2)	

Ordering example (see P. 480):
MN2004 HM 20.99 H7 AS

Dimensions in mm.

Additional dimensions available upon request.

Adjustment instructions and installation of the accessories, see technical appendix.

* Values indicate the sizes for different diameters (adjustable only within a tolerance field), not the adjustment range.

** With 1 mm long centring pin for d₁ smaller than 8.3 mm.

Please indicate the desired guide pad quality (HM, cermet) when ordering.

Unless otherwise indicated, the guide pads will be delivered in HM quality.

Tools with guide pads in PCD quality available from Ø 8 mm.

Reconditioning possible from Ø 8.00 for technical reasons.

Price and delivery time for tools with guide pads in PCD quality on request.

For suitable indexable insert, see chapter indexable inserts from page 494.

WP single bladed reamer MN2034

Ultra-short design

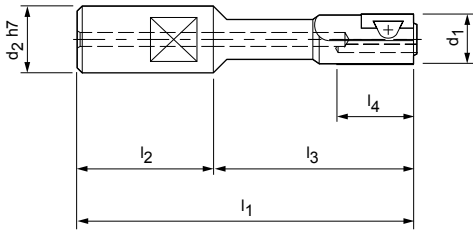

Dimensions							Accessories				
d ₁ *	d ₂ H7	l ₁	l ₂	l ₃	l ₄	Indexable insert size	Clamping		Adjusting		
							Torx screw/threaded spindle	Clamping plate	Threaded pin MN 620	Adjusting wedge MN 619	
							Order no. (size)				
5,90 - 6,29	16	85**	27	58	15	(SP) 81	Torx screw	10036776 (M1,6x3,9)	30026285 (GR - 1YN)	10036737 (M2x2)	30026239 (GR - 06)
6,30 - 7,29	16	85**	27	58	15	(SP) 81		10036778 (M1,6x4,4)	30026285 (GR - 1YN)	10036738 (M2x2,5)	30026239 (GR - 06)
7,30 - 8,29	16	85**	27	58	15	(SP) 81		10036781 (M2x5)	30026286 (GR - 1X)	10036739 (M2x3)	30026260 (GR - 07)
8,30 - 9,79	16	85	27	58	15	90		10036784 (M2,5x5,2)	30026287 (GR - 1W)	10036732 (M2,5x3)	30026262 (GR - 09)
9,80 - 10,29	16	85	27	58	15	90		10036784 (M2,5x5,2)	30026287 (GR - 1W)	10036733 (M2,5x4)	30026262 (GR - 09)
10,30 - 11,29	16	85	27	58	30	90	Threaded spindle MN 618	10036722 (M3LH/RHx6)	30026289 (GR - 0N)	10036744 (M3x3)	30026263 (GR - 1)
11,30 - 12,29	16	85	27	58	30	90		10036722 (M3LH/RHx6)	30026289 (GR - 0N)	10036745 (M3x4)	30026263 (GR - 1)
12,30 - 14,29	16	85	27	58	30	91		10036722 (M3LH/RHx6)	30026292 (GR - 1N)	10036745 (M3x4)	30026263 (GR - 1)
14,30 - 16,29	16	85	27	58	30	91		10036722 (M3LH/RHx6)	30026292 (GR - 1N)	10036747 (M3x6)	30026263 (GR - 1)
16,30 - 17,29	16	85	27	58	30	92		10036725 (M4x0,5LH/RHx9)	30026296 (GR - 2N)	10036753 (M4x5)	30026266 (GR - 2)
17,30 - 19,79	16	85	27	58	30	92		10036725 (M4x0,5LH/RHx9)	30026296 (GR - 2N)	10036754 (M4x6)	30026266 (GR - 2)
19,80 - 20,29	16	85	27	58	30	92		10036725 (M4x0,5LH/RHx9)	30026296 (GR - 2N)	10036755 (M4x8)	30026266 (GR - 2)
20,30 - 26,30	20	90	30	60	30	92		10036725 (M4x0,5LH/RHx9)	30026296 (GR - 2N)	10036755 (M4x8)	30026266 (GR - 2)
26,30 - 30,29	25	90	30	60	30	92		10036725 (M4x0,5LH/RHx9)	30026296 (GR - 2N)	10036755 (M4x8)	30026266 (GR - 2)

Ordering example (see P. 480):

MN2034 HM 20.99 H7 AS

Dimensions in mm.

Additional dimensions available upon request.

SP = indexable blade, not reversible.

Adjustment instructions and installation of the accessories, see technical appendix.

* Values indicate the sizes for different diameters (adjustable only within a tolerance field), not the adjustment range.

** With 1 mm long centring pin for d₁ smaller than 8.3 mm.

Please indicate the desired guide pad quality (HM, cermet) when ordering.

Unless otherwise indicated, the guide pads will be delivered in HM quality.

Tools with guide pads in PCD quality available from Ø 8 mm.

Reconditioning possible from Ø 8.00 for technical reasons.

Price and delivery time for tools with guide pads in PCD quality on request.

For suitable indexable insert, see chapter indexable inserts from page 494.

WP single bladed reamer MN2023

NC design

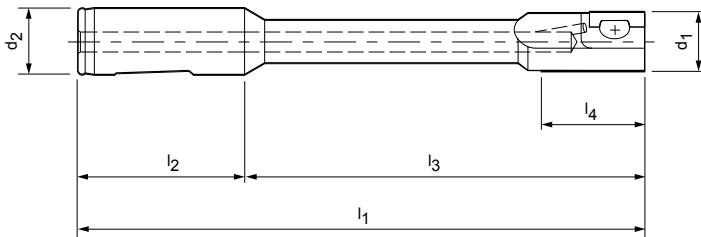

Dimensions							Accessories			
d ₁ *	d ₂ (-0.003)	l ₁	l ₂	l ₃	l ₄	Indexable insert size	Clamping		Adjusting	
							Threaded spindle MN 618	Clamping plate	Threaded pin MN 620	Adjusting wedge MN 619
							Order no. (size)			
7,80 - 8,29	16	133	48	85	30	90	10036711 (M3LH/RHx5)	30026288 (GR - 0F)	10036743 (M3x2,5)	30026238 (GR - 0)
8,30 - 8,79	16	133	48	85	30	90	10036711 (M3LH/RHx5)	30026288 (GR - 0F)	10036744 (M3x3)	30026238 (GR - 0)
8,80 - 9,29	16	133	48	85	30	90	10036711 (M3LH/RHx5)	30026289 (GR - 0N)	10036744 (M3x3)	30026238 (GR - 0)
9,30 - 11,29	16	133	48	85	30	91	10036722 (M3LH/RHx6)	30026292 (GR - 1N)	10036744 (M3x3)	30026263 (GR - 1)
11,30 - 11,79	16	133	48	85	30	92	10036724 (M4x0,5LH/RHx6,5)	30026294 (GR - 2F)	10036751 (M4x3)	30026266 (GR - 2)
11,80 - 12,29	16	168	48	120	30	92	10036724 (M4x0,5LH/RHx6,5)	30026294 (GR - 2F)	10036751 (M4x3)	30026266 (GR - 2)
12,30 - 13,29	16	168	48	120	30	92	10036724 (M4x0,5LH/RHx6,5)	30026294 (GR - 2F)	10036752 (M4x4)	30026266 (GR - 2)
13,30 - 14,29	16	168	48	120	30	92	10036725 (M4x0,5LH/RHx9)	30026296 (GR - 2N)	10036753 (M4x5)	30026266 (GR - 2)
14,30 - 15,79	20	170	50	120	30	92	10036725 (M4x0,5LH/RHx9)	30026296 (GR - 2N)	10036753 (M4x5)	30026266 (GR - 2)
15,80 - 17,79	20	170	50	120	30	92	10036725 (M4x0,5LH/RHx9)	30026296 (GR - 2N)	10036753 (M4x5)	30026266 (GR - 2)
17,80 - 18,29	20	170	50	120	30	92	10036725 (M4x0,5LH/RHx9)	30026296 (GR - 2N)	10036753 (M4x5)	30026266 (GR - 2)
18,30 - 19,79	20	170	50	120	30	92	10036725 (M4x0,5LH/RHx9)	30026296 (GR - 2N)	10036754 (M4x6)	30026266 (GR - 2)
19,80 - 24,79	20	170	50	120	30	92	10036725 (M4x0,5LH/RHx9)	30026296 (GR - 2N)	10036755 (M4x8)	30026266 (GR - 2)
24,80 - 29,29	20	170	50	120	30	93	10036725 (M4x0,5LH/RHx9)	30026298 (GR - 3N)	10036761 (M6x10)	30026279 (GR - 4)
28,80 - 30,79	20	170	50	120	30	93	10036725 (M4x0,5LH/RHx9)	30026298 (GR - 3N)	10036762 (M6x12)	30026279 (GR - 4)

Ordering example (see P. 480):

MN2023 HM 20.99 H7 AS

Dimensions in mm.

Additional dimensions available upon request.

Adjustment instructions and installation of the accessories, see technical appendix.

* Values indicate the sizes for different diameters (adjustable only within a tolerance field), not the adjustment range.

Please indicate the desired guide pad quality (HM, cermet) when ordering.

Unless otherwise indicated, the guide pads will be delivered in HM quality.

Tools with guide pads in PCD quality available from Ø 8 mm.

Reconditioning possible from Ø 8.00 for technical reasons.

Price and delivery time for tools with guide pads in PCD quality on request.

For suitable indexable insert, see chapter indexable inserts from page 494.

WP single bladed reamer MN2024

NC design

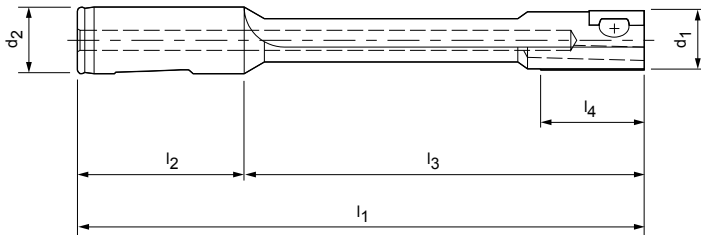

Dimensions							Accessories			
d ₁ *	d ₂ (-0,003)	l ₁	l ₂	l ₃	l ₄	Indexable insert size	Clamping		Adjusting	
							Threaded spindle MN 618	Clamping plate	Threaded pin MN 620	Adjusting wedge MN 619
Order no. (size)										
7,80 - 8,29	16	133	48	85	30	90	10036711 (M3LH/RHx5)	30026291 (GR - OZ)	10036743 (M3x2,5)	30026238 (GR - 0)
8,30 - 8,79	16	133	48	85	30	90	10036711 (M3LH/RHx5)	30026291 (GR - OZ)	10036744 (M3x3)	30026238 (GR - 0)
8,80 - 9,29	16	133	48	85	30	90	10036711 (M3LH/RHx5)	30026291 (GR - OZ)	10036744 (M3x3)	30026238 (GR - 0)
9,30 - 11,29	16	133	48	85	30	90	10036722 (M3LH/RHx6)	30026289 (GR - ON)	10036744 (M3x3)	30026263 (GR - 1)
11,30 - 11,79	16	133	48	85	30	90	10036722 (M3LH/RHx6)	30026289 (GR - ON)	10036745 (M3x4)	30026263 (GR - 1)
11,80 - 12,29	16	168	48	120	30	90	10036722 (M3LH/RHx6)	30026289 (GR - ON)	10036745 (M3x4)	30026263 (GR - 1)
12,30 - 14,29	16	168	48	120	30	91	10036722 (M3LH/RHx6)	30026292 (GR - 1N)	10036745 (M3x4)	30026263 (GR - 1)
14,30 - 16,29	20	170	50	120	30	91	10036722 (M3LH/RHx6)	30026292 (GR - 1N)	10036747 (M3x6)	30026263 (GR - 1)
16,30 - 17,29	20	170	50	120	30	92	10036725 (M4x0,5LH/RHx9)	30026296 (GR - 2N)	10036753 (M4x5)	30026266 (GR - 2)
17,30 - 19,79	20	170	50	120	30	92	10036725 (M4x0,5LH/RHx9)	30026296 (GR - 2N)	10036754 (M4x6)	30026266 (GR - 2)
19,80 - 20,79	20	170	50	120	30	92	10036725 (M4x0,5LH/RHx9)	30026296 (GR - 2N)	10036755 (M4x8)	30026266 (GR - 2)

Ordering example (see P. 480):

MN2024 HM 11.99 H7 AS

Dimensions in mm.

Additional dimensions available upon request.

Adjustment instructions and installation of the accessories, see technical appendix.

* Values indicate the sizes for different diameters (adjustable only within a tolerance field), not the adjustment range.

Please indicate the desired guide pad quality (HM, cermet) when ordering.

Unless otherwise indicated, the guide pads will be delivered in HM quality.

Tools with guide pads in PCD quality available from Ø 8 mm.

Reconditioning possible from Ø 8.00 for technical reasons.

Price and delivery time for tools with guide pads in PCD quality on request.

For suitable indexable insert, see chapter indexable inserts from page 494.

WP single bladed reamer MN2043

NC design

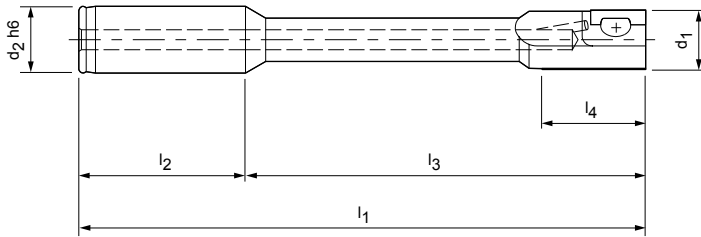

Dimensions							Accessories			
d ₁ *	d ₂ h6	l ₁	l ₂	l ₃	l ₄	Indexable insert size	Clamping		Adjusting	
							Threaded spindle MN 618	Clamping plate	Threaded pin MN 620	Adjusting wedge MN 619
							Order no. (size)			
7,80 - 8,29	16	133	48	85	30	90	10036711 (M3LH/RHx5)	30026288 (GR - 0F)	10036743 (M3x2,5)	30026238 (GR - 0)
8,30 - 8,79	16	133	48	85	30	90	10036711 (M3LH/RHx5)	30026288 (GR - 0F)	10036744 (M3x3)	30026238 (GR - 0)
8,80 - 9,29	16	133	48	85	30	90	10036711 (M3LH/RHx5)	30026289 (GR - 0N)	10036744 (M3x3)	30026238 (GR - 0)
9,30 - 11,29	16	133	48	85	30	91	10036722 (M3LH/RHx6)	30026292 (GR - 1N)	10036744 (M3x3)	30026263 (GR - 1)
11,30 - 11,79	16	133	48	85	30	92	10036724 (M4x0,5LH/RHx6,5)	30026294 (GR - 2F)	10036751 (M4x3)	30026266 (GR - 2)
11,80 - 12,29	16	168	48	120	30	92	10036724 (M4x0,5LH/RHx6,5)	30026294 (GR - 2F)	10036751 (M4x3)	30026266 (GR - 2)
12,30 - 13,29	16	168	48	120	30	92	10036724 (M4x0,5LH/RHx6,5)	30026294 (GR - 2F)	10036752 (M4x4)	30026266 (GR - 2)
13,30 - 14,29	16	168	48	120	30	92	10036725 (M4x0,5LH/RHx9)	30026296 (GR - 2N)	10036753 (M4x5)	30026266 (GR - 2)
14,30 - 15,79	20	170	50	120	30	92	10036725 (M4x0,5LH/RHx9)	30026296 (GR - 2N)	10036753 (M4x5)	30026266 (GR - 2)
15,80 - 17,79	20	170	50	120	30	92	10036725 (M4x0,5LH/RHx9)	30026296 (GR - 2N)	10036753 (M4x5)	30026266 (GR - 2)
17,80 - 18,29	20	170	50	120	30	92	10036725 (M4x0,5LH/RHx9)	30026296 (GR - 2N)	10036753 (M4x5)	30026266 (GR - 2)
18,30 - 19,79	20	170	50	120	30	92	10036725 (M4x0,5LH/RHx9)	30026296 (GR - 2N)	10036754 (M4x6)	30026266 (GR - 2)
19,80 - 24,79	20	170	50	120	30	92	10036725 (M4x0,5LH/RHx9)	30026296 (GR - 2N)	10036755 (M4x8)	30026266 (GR - 2)
24,80 - 28,79	20	170	50	120	30	93	10036725 (M4x0,5LH/RHx9)	30026298 (GR - 3N)	10036761 (M6x10)	30026279 (GR - 4)
28,80 - 31,79	20	170	50	120	30	93	10036725 (M4x0,5LH/RHx9)	30026298 (GR - 3N)	10036762 (M6x12)	30026279 (GR - 4)
31,80 - 37,79	20	170	50	120	30	93	10036725 (M4x0,5LH/RHx9)	30026298 (GR - 3N)	10036764 (M6x15)	30026279 (GR - 4)
37,80 - 40,29	25	176	56	120	30	93	10036725 (M4x0,5LH/RHx9)	30026298 (GR - 3N)	10036764 (M6x15)	30026279 (GR - 4)

Ordering example (see P. 480):

MN2043 HM 20.99 H7 AS

Dimensions in mm.

Additional dimensions available upon request.

Adjustment instructions and installation of the accessories, see technical appendix.

* Values indicate the sizes for different diameters (adjustable only within a tolerance field), not the adjustment range.

Please indicate the desired guide pad quality (HM, cermet) when ordering.

Unless otherwise indicated, the guide pads will be delivered in HM quality.

Tools with guide pads in PCD quality available from Ø 8 mm.

Reconditioning possible from Ø 8.00 for technical reasons.

Price and delivery time for tools with guide pads in PCD quality on request.

For suitable indexable insert, see chapter indexable inserts from page 494.

WP single bladed reamer MN2044

NC design

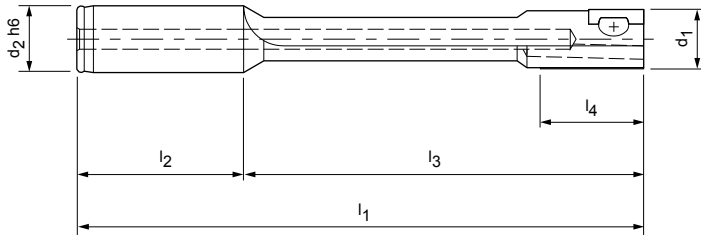

Dimensions							Accessories			
d ₁ *	d ₂ h6	l ₁	l ₂	l ₃	l ₄	Indexable insert size	Clamping		Adjusting	
							Threaded spindle MN 618	Clamping plate	Threaded pin MN 620	Adjusting wedge MN 619
Order no. (size)										
7,80 - 8,29	16	133	48	85	30	90	10036711 (M3LH/RHx5)	30026291 (GR - OZ)	10036743 (M3x2,5)	30026238 (GR - 0)
8,30 - 8,79	16	133	48	85	30	90	10036711 (M3LH/RHx5)	30026291 (GR - OZ)	10036744 (M3x3)	30026238 (GR - 0)
8,80 - 9,29	16	133	48	85	30	90	10036711 (M3LH/RHx5)	30026291 (GR - OZ)	10036744 (M3x3)	30026238 (GR - 0)
9,30 - 11,29	16	133	48	85	30	90	10036722 (M3LH/RHx6)	30026289 (GR - ON)	10036744 (M3x3)	30026263 (GR - 1)
11,30 - 11,79	16	133	48	85	30	90	10036722 (M3LH/RHx6)	30026289 (GR - ON)	10036745 (M3x4)	30026263 (GR - 1)
11,80 - 12,29	16	168	48	120	30	90	10036722 (M3LH/RHx6)	30026289 (GR - ON)	10036745 (M3x4)	30026263 (GR - 1)
12,30 - 14,29	16	168	48	120	30	91	10036722 (M3LH/RHx6)	30026292 (GR - 1N)	10036745 (M3x4)	30026263 (GR - 1)
14,30 - 16,29	20	170	50	120	30	91	10036722 (M3LH/RHx6)	30026292 (GR - 1N)	10036747 (M3x6)	30026263 (GR - 1)
16,30 - 17,29	20	170	50	120	30	92	10036725 (M4x0,5LH/RHx9)	30026296 (GR - 2N)	10036753 (M4x5)	30026266 (GR - 2)
17,30 - 19,79	20	170	50	120	30	92	10036725 (M4x0,5LH/RHx9)	30026296 (GR - 2N)	10036754 (M4x6)	30026266 (GR - 2)
19,80 - 20,79	20	170	50	120	30	92	10036725 (M4x0,5LH/RHx9)	30026296 (GR - 2N)	10036755 (M4x8)	30026266 (GR - 2)

Ordering example (see P. 480):

MN2044 HM 11.99 H7 AS

Dimensions in mm.

Additional dimensions available upon request.

Adjustment instructions and installation of the accessories, see technical appendix.

* Values indicate the sizes for different diameters (adjustable only within a tolerance field), not the adjustment range.

Please indicate the desired guide pad quality (HM, cermet) when ordering.

Unless otherwise indicated, the guide pads will be delivered in HM quality.

Tools with guide pads in PCD quality available from Ø 8 mm.

Reconditioning possible from Ø 8.00 for technical reasons.

Price and delivery time for tools with guide pads in PCD quality on request.

For suitable indexable insert, see chapter indexable inserts from page 494.

Indexable inserts with AS lead

For tools with guide pads

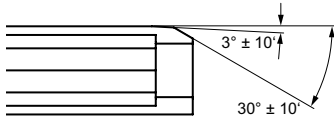

AS lead

Lead suitable for all materials, high surface quality even at high cutting speeds. Lead length 1.3 mm.

Max. cutting depth: 0.25 mm
 Rake angle: 0°, 6°, 12°

Cutting material	Carbide								
MMG*	P			M	K		N		
	1.1 - 1.2	2 - 3 5	P4 P6	1 - 3	1.1	2 - 3	1.1 - 1.2	2.3	2.1 - 2.2
Cutting material type	HP115	HP425	HP016	HP016	HC418	HP426	HP612	HU615	

Rake angle	Size	Specification	Order no.							
negative	81	SP-AS81R0-...								
	90	SP-AS90R0-...								
	91	SP-AS91R0-...								
	92	SP-AS92R0-...								
	93	SP-AS93R0-...								

neutral	81	SP-AS81R0-...								
	90	WP-AS90R0-...								
	91	WP-AS91R0-...								
	92	WP-AS92R0-...								
	93	WP-AS93R0-...								

positive	81	SP-AS81R6-...	30669442	30669444	31100866	31100866				30669441	
	90	WP-AS90R6-...	30668837	30668839	31100867	31100867				30668836	
	91	WP-AS91R6-...	30668848	30668850	31080268	31080268				30668847	
	92	WP-AS92R6-...	30668858	30668859	30912087	30912087				30668857	
	93	WP-AS93R6-...	30668869	30250310	30915826	30915826				30668868	

highly positive	81	SP-AS81R2-...								30685605		30669437
	90	WP-AS90R2-...								30685606		30668833
	91	WP-AS91R2-...								30685607		30668844
	92	WP-AS92R2-...								30685608		30668853
	93	WP-AS93R2-...								30685609		30668863

* MAPAL machining groups.



Carbide		
S		H
1 - 2		1.1
HU615		HP016

Cermet	
P	
1 - 3 5	
CP122	

PCD	
N	
1 - 2	
PU620	

PcBN		
K		H
1.1		1.1 - 1.2
FU485		FU801

Order no.		

Order no.	

Order no.	

Order no.		

30668838	
30668849	
30357069	
30305745	

	30669189**
	30669191**
	30669194**
	30669197*
	30669199**

	30669437	
	30668833	
	30668844	
	30668853	
	30668863	

For cutting data recommendations, see end of chapter.
Cutting edges with special lead available on request.

Indexable inserts with AZ lead

For tools with guide pads

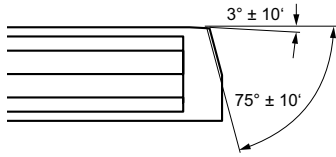

AZ lead

For high cutting speeds; especially suitable for aluminium machining.

Max. cutting depth: 0.5 mm
Rake angle: 0°, 6°, 12°

Cutting material	Carbide								
MMG*	P				M	K	N		
Cutting material type	1.1 - 1.2	2 - 3 5	4 6	1 - 3	1.1	2 - 3	1.1 - 1.2	2.3	2.1 - 2.2
	HP115	HP425	HP016	HP016	HC418	HP426	HP612	HU615	

Rake angle	Size	Specification	Order no.							
negative	81	SP-AZ81R0-...								
	90	SP-AZ90R0-...								
	91	SP-AZ91R0-...								
	92	SP-AZ92R0-...								
	93	SP-AZ93R0-...								

neutral	81	SP-AZ81R0-...					30685624				
	90	WP-AZ90R0-...					30670062				
	91	WP-AZ91R0-...					30685625				
	92	WP-AZ92R0-...					30664930				
	93	WP-AZ93R0-...					30664935				

positive	81	SP-AZ81R6-...						30914241		30668876	
	90	WP-AZ90R6-...						30914251		30668884	
	91	WP-AZ91R6-...						30914261		30668891	
	92	WP-AZ92R6-...						30914275		30668903	
	93	WP-AZ93R6-...						30914304		30668912	

highly positive	81	SP-AZ81R2-...							30685639		30668875
	90	WP-AZ90R2-...							30685640		30668881
	91	WP-AZ91R2-...							30685641		30668889
	92	WP-AZ92R2-...							30685642		30668899
	93	WP-AZ93R2-...							30685643		30668908

* MAPAL machining groups.

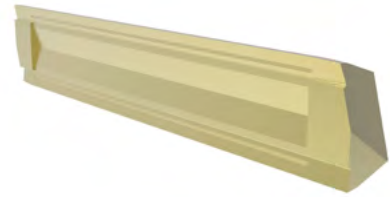

Carbide		
S		H
1 - 2		1.1
HU615		HP016

Cermet	
P	
1 - 3 5	
CP122	

PCD	
N	
1 - 2	
PU620	

PcBN		
K		H
1.1		1.1 - 1.2
FU485		FU801

Order no.		

Order no.	

Order no.	

Order no.		

	30669205**
	30669207**
	30669210**
	30669215**
	30669218**

For cutting data recommendations, see end of chapter.
Cutting edges with special lead available on request.

Indexable inserts with DZ lead

For tools with guide pads

DZ lead

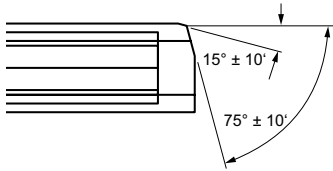

Especially for short chipping materials (grey cast iron) and large cutting depths. The 15° lead angle of the finishing edge slightly increases the radial forces, making it suitable for thin-walled workpieces as well.

Max. cutting depth: 0.15 mm
 Rake angle: 0°, 6°, 12°

Cutting material	Carbide								
MMG*	P				M	K	N		
Cutting material type	1.1 - 1.2	2 - 3 5	4 6	1 - 3	1.1	2 - 3	1.1 - 1.2	2.3	2.1 - 2.2
	HP115	HP425	HP016	HP016	HC418	HP426	HP612	HU615	

Rake angle	Size	Specification	Order no.							
negative	81	SP-DZ81R0-...								
	90	SP-DZ90R0-...								
	91	SP-DZ91R0-...								
	92	SP-DZ92R0-...								
	93	SP-DZ93R0-...								

neutral	81	SP-DZ81R0-...					30685653				
	90	WP-DZ90R0-...					30685654				
	91	WP-DZ91R0-...					30664932				
	92	WP-DZ92R0-...					30685655				
	93	WP-DZ93R0-...					30667699				

positive	81	SP-DZ81R6-...	30668927	30668928	31090592	31090592		30914351		30668926	
	90	WP-DZ90R6-...	30668936	30668785	31034657	31034657		30914370		30668935	
	91	WP-DZ91R6-...	30668949	30668950	31028496	31028496		30914400		30668947	
	92	WP-DZ92R6-...	30668960	30668961	31100878	31100878		30914435		30668959	
	93	WP-DZ93R6-...	30668969	30668970	31069730	31069730		30914474		30668968	

highly positive	81	SP-DZ81R2-...								30685663		30668923
	90	WP-DZ90R2-...								30685664		30668933
	91	WP-DZ91R2-...								30685665		30668942
	92	WP-DZ92R2-...								30685666		30668956
	93	WP-DZ93R2-...								30685667		30668965

* MAPAL machining groups.

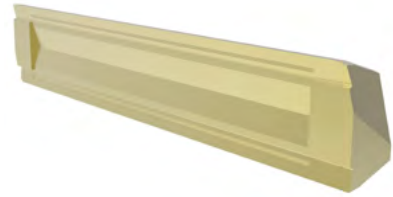

Carbide		
S		H
1 - 2		1.1
HU615		HP016

Cermet	
P	
1 - 3 5	
CP122	

PCD	
N	
1 - 2	
PU620	

PcBN	
K	H
1.1	1.1 - 1.2
FU485	FU801

Order no.	

Order no.

Order no.

Order no.	
30262157**	30011418**
30490660**	30020729**
30174899**	30669469**
30502436**	30669472**

	31090592
	31034657
	31028496
	31100878
	31069730

30773222
30668948
30314334
30895254

30669224**
30669464**
30669467**
30669471**
30669473**

	30668923
	30668933
	30668942
	30668956
	30668965

Indexable inserts with EK lead

For tools with guide pads

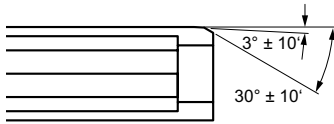

EK lead (face cutting design)

Only use if a small lead length of 0.6 mm is required, for all work-piece material, do not exceed max. feed rate of 0.2 mm/rev.

Max. cutting depth: 0.15 mm
 Rake angle: 0°, 6°, 12°

Cutting material	Carbide									
MMG*	P			M		K		N		
	1.1 - 1.2	2 - 3 5	4 6	1 - 3	1.1	2 - 3	1.1 - 1.2	2.3	2.1 - 2.2	
Cutting material type	HP115	HP425	HP016	HP016	HC418	HP426	HP612	HU615		

Rake angle	Size	Specification	Order no.							
negative	181	SP-EK181R0-...								
	150	SP-EK150R0-...								
	151	SP-EK151R0-...								
	152	SP-EK152R0-...								
	153	SP-EK153R0-...								

neutral	181	SP-EK181R0-...								
	150	WP-EK150R0-...								
	151	WP-EK151R0-...								
	152	WP-EK152R0-...								
	153	WP-EK153R0-...								

positive	181	SP-EK181R6-...	30681706	30681707	31100872	31100872				30681705
	150	WP-EK150R6-...	30668978	30668979	31100873	31100873				30668977
	151	WP-EK151R6-...	30668987	30389077	31049120	31049120				30668986
	152	WP-EK152R6-...	30668999	30669000	30990556	30990556				30668998
	153	WP-EK153R6-...	30669009	30669010	31100874	31100874				30669008

highly positive	181	SP-EK181R2-...								30685689	30681702
	150	WP-EK150R2-...								30685690	30668974
	151	WP-EK151R2-...								30685691	30668983
	152	WP-EK152R2-...								30685692	30668993
	153	WP-EK153R2-...								30685693	30669006

* MAPAL machining groups.



Carbide		
S		H
1 - 2		1.1
HU615		HP016

Cermet	
P	
1 - 3 5	
CP122	

PCD	
N	
1 - 2	
PU620	

PcBN		
K		H
1.1 - 1.2		
FU485		FU801

Order no.		

Order no.	

Order no.	

Order no.		

30685694	
30685695	
30313884	
30543106	

	30681710**
	30669474**
	30669475**
	30669477**
	30669479**

	30681702	
	30668974	
	30668983	
	30668993	
	30669006	

Indexable inserts with SZ lead

For tools with guide pads

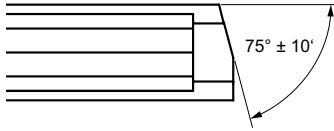

SZ lead

Especially for aluminium cast alloys, very good surface at small feed rates. Gauges are met exactly. The lead angle of the main cutter of 75° reduces the radial forces, making it particularly suitable for thin-walled workpieces.

Max. cutting depth: 1.00 mm
 Rake angle: $6^\circ, 12^\circ$

Cutting material	Carbide									
MMG*	P			M		K		N		
	1.1 - 1.2	2 - 3 5	4 6	1 - 3	1.1	2 - 3	1.1 - 1.2	2.3	2.1 - 2.2	
Cutting material type	HP115	HP425	HP016	HP016	HC418	HP426	HP612	HU615		

Rake angle	Size	Specification	Order no.							
negative	81	SP-SZ81R0-...								
	90	SP-SZ90R0-...								
	91	SP-SZ91R0-...								
	92	SP-SZ92R0-...								
	93	SP-SZ93R0-...								

neutral	81	SP-SZ81R0-...								
	90	WP-SZ90R0-...								
	91	WP-SZ91R0-...								
	92	WP-SZ92R0-...								
	93	WP-SZ93R0-...								

positive	81	SP-SZ81R6-...							31306727	30669514
	90	WP-SZ90R6-...							31306729	30669523
	91	WP-SZ91R6-...							31306730	30669534
	92	WP-SZ92R6-...							30690795	30669541
	93	WP-SZ93R6-...							31306732	30669549

highly positive	81	SP-SZ81R2-...								30669511
	90	WP-SZ90R2-...								30669520
	91	WP-SZ91R2-...								30669531
	92	WP-SZ92R2-...								30669538
	93	WP-SZ93R2-...								30669546

* MAPAL machining groups.

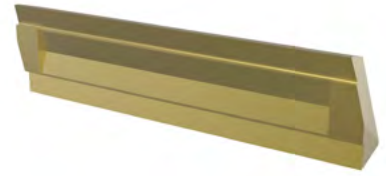

Carbide		
S		H
1 - 2		1.1
HU615		HP016

Cermet	
P	
1 - 3 5	
CP122	

PCD	
N	
1 - 2	
PU620	

PcBN		
K		H
1.1 - 1.2		
FU485		FU801

Order no.		

Order no.	

Order no.	

Order no.		

	30669493**
	30669494**
	30669495**
	30669498**
	30669502**

For cutting data recommendations, see end of chapter.
Cutting edges with special lead available on request.

Cutting data recommendation for indexable inserts with AS lead

Feed and cutting speed

AS-HP115

MMG*		Workpiece material	Strength/hardness [N/mm ²] [HRC]	Cutting speed v _c (m/min)		Feed f _z (mm/z)
				Internal cooling	External cooling	
P	P1	Structural, free-cutting, case hardened and heat-treated steels, non-alloy	< 700	80	40	0.150
	P1.2	Structural, free-cutting, case hardened and heat-treated steels, non-alloy	< 1200	70	35	0.150

AS-HP425

MMG*		Workpiece material	Strength/hardness [N/mm ²] [HRC]	Cutting speed v _c (m/min)		Feed f _z (mm/z)
				Internal cooling	External cooling	
P	P2	Nitrided, case hardened and heat-treated steels, alloy	< 900	100	50	0.150
	P2.2	Nitrided, case hardened and heat-treated steels, alloy	< 1400	80	40	0.150
	P3	Tool, bearing, spring and high-speed steels**	< 900	100	50	0.150
	P3.2	Tool, bearing, spring and high-speed steels**	< 1500	80	40	0.150
	P5	P5.1 Cast steel		80	40	0.150

AS-HP016

MMG*		Workpiece material	Strength/hardness [N/mm ²] [HRC]	Cutting speed v _c (m/min)		Feed f _z (mm/z)
				Internal cooling	External cooling	
P	P4	P4.1 Stainless steels, ferritic and martensitic		50	25	0.120
	P6	P6.1 Stainless cast steel, ferritic and martensitic		40	20	0.120
M	M1	M1.1 Stainless steels, austenitic	< 700	50	25	0.120
	M1.2	M1.2 Stainless steels, ferritic/austenitic (duplex)	< 1000	30	15	0.120
	M2	M2.1 Stainless/heat-resistant cast steel, austenitic	< 700	50	25	0.120
M3	M3.1 Stainless cast steel, ferritic/austenitic (duplex)	< 1000	30	15	0.120	

AS-HP612

MMG*		Workpiece material	Strength/hardness [N/mm ²] [HRC]	Cutting speed v _c (m/min)		Feed f _z (mm/z)
				Internal cooling	External cooling	
N	N1	N1.1 Aluminium, non-alloy and alloy < 3 % Si		160	80	0.150
	N1.2	N1.2 Aluminium, alloy ≤ 7 % Si		160	80	0.150

* MAPAL machining groups

** If the alloy parts Cr, Mo, Ni, V, W in total > 8% then select the next highest MAPAL machining group.

AS-HU615

MMG*		Workpiece material	Strength/hardness [N/mm ²] [HRC]	Cutting speed v _c (m/min)		Feed f _z (mm/z)	
				Internal cooling	External cooling		
N	N2	N2.1	Copper, unalloyed and low-alloyed	< 300	100	50	0.150
		N2.2	Copper, alloy	> 300	100	50	0.150
		N2.3	Brass, bronze, gunmetal	< 1200	100	50	0.150
S	S1	S1.1	Titanium, titanium alloys	< 400	30	15	0.120
		S2.1	Titanium, titanium alloys	< 1200	20	10	0.120
		S2.2	Titanium, titanium alloys	> 1200	20	10	0.100

AS-CP122

MMG*		Workpiece material	Strength/hardness [N/mm ²] [HRC]	Cutting speed v _c (m/min)		Feed f _z (mm/z)	
				Internal cooling	External cooling		
P1	P1	P1.1	Structural, free-cutting, case hardened and heat-treated steels, non-alloy	< 700	180	90	0.150
		P1.2	Structural, free-cutting, case hardened and heat-treated steels, non-alloy	< 1200	160	80	0.120
P2	P2	P2.1	Nitrided, case hardened and heat-treated steels, alloy	< 900	160	80	0.150
		P2.2	Nitrided, case hardened and heat-treated steels, alloy	< 1400	140	70	0.120
P3	P3	P3.1	Tool, bearing, spring and high-speed steels**	< 800	160	80	0.150
		P3.2	Tool, bearing, spring and high-speed steels**	< 1000	160	80	0.150
P5	P5	P3.3	Tool, bearing, spring and high-speed steels**	< 1500	140	70	0.120
		P5.1	Cast steel		140	70	0.120

AS-PU620

MMG*		Workpiece material	Strength/hardness [N/mm ²] [HRC]	Cutting speed v _c (m/min)		Feed f _z (mm/z)	
				Internal cooling	External cooling		
N	N1	N1.1	Aluminium, non-alloy and alloy < 3 % Si		230	115	0.150
		N1.2	Aluminium, alloy ≤ 7 % Si		230	115	0.150
		N1.3	Aluminium, alloy > 7-12 % Si		230	115	0.150
		N1.4	Aluminium, alloy > 12 % Si		230	115	0.150
N2	N2	N2.1	Copper, unalloyed and low-alloyed	< 300	180	90	0.150
		N2.2	Copper, alloy	> 300	180	90	0.150
		N2.3	Brass, bronze, gunmetal	< 1200	180	90	0.150

The specified cutting values are guide values.

The optimum data for the respective machining task should be determined during the test or machining.

Cutting data recommendation for indexable inserts with AZ lead

Feed and cutting speed

AZ-HC418

MMG*	Workpiece material	Strength/hardness [N/mm ²] [HRC]	Cutting speed v _c (m/min)		Feed f _z (mm/z)
			Internal cooling	External cooling	
K K1 K1.1	Cast iron with lamellar graphite (grey cast iron), GJL	< 300	110	55	0.150

AZ-HP426

MMG*	Workpiece material	Strength/hardness [N/mm ²] [HRC]	Cutting speed v _c (m/min)		Feed f _z (mm/z)
			Internal cooling	External cooling	
K K2	K2.1 Cast iron with spheroidal graphite, GJS	< 500	110	55	0.150
	K2.2 Cast iron with spheroidal graphite, GJS	≤ 800	100	50	0.150
	K2.3 Cast iron with spheroidal graphite, GJS	> 800	80	40	0.150
K K3	K3.1 Cast iron with spheroidal graphite, GJV; malleable cast iron, GJM	< 500	80	40	0.150
	K3.2 Cast iron with spheroidal graphite, GJV; malleable cast iron, GJM	> 500	80	40	0.150

AZ-HP612

MMG*	Workpiece material	Strength/hardness [N/mm ²] [HRC]	Cutting speed v _c (m/min)		Feed f _z (mm/z)
			Internal cooling	External cooling	
N N1	N1.1 Aluminium, non-alloy and alloy < 3 % Si		160	80	0.150
	N1.2 Aluminium, alloy ≤ 7 % Si		160	80	0.150

AZ-HU615

MMG*	Workpiece material	Strength/hardness [N/mm ²] [HRC]	Cutting speed v _c (m/min)		Feed f _z (mm/z)
			Internal cooling	External cooling	
N2	N2.1 Copper, unalloyed and low-alloyed	< 300	110	55	0.150
	N2.2 Copper, alloy	> 300	110	55	0.150
	N2.3 Brass, bronze, gunmetal	< 1200	110	55	0.150

AZ-PU620

MMG*	Workpiece material	Strength/hardness [N/mm ²] [HRC]	Cutting speed v _c (m/min)		Feed f _z (mm/z)	
			Internal cooling	External cooling		
N	N1	N1.1 Aluminium, non-alloy and alloy < 3 % Si	230	115	0.150	
		N1.2 Aluminium, alloy ≤ 7 % Si	230	115	0.150	
		N1.3 Aluminium, alloy > 7-12 % Si	230	115	0.150	
		N1.4 Aluminium, alloy > 12 % Si	230	115	0.150	
N	N2	N2.1 Copper, unalloyed and low-alloyed	< 300	180	90	0.150
		N2.2 Copper, alloy	> 300	180	90	0.150
		N2.3 Brass, bronze, gunmetal	< 1200	180	90	0.150

AZ-FU485

MMG*	Workpiece material	Strength/hardness [N/mm ²] [HRC]	Cutting speed v _c (m/min)		Feed f _z (mm/z)
			Internal cooling	External cooling	
K K1	K1.1 Cast iron with lamellar graphite (grey cast iron), GJL	< 300	160	80	0.150

The specified cutting values are guide values.

The optimum data for the respective machining task should be determined during the test or machining.

Cutting data recommendation for indexable inserts with DZ lead

Feed and cutting speed

DZ-HP115

MMG*	Workpiece material	Strength/hardness [N/mm ²] [HRC]	Cutting speed v _c (m/min)		Feed f _z (mm/z)	
			Internal cooling	External cooling		
P P1	P1.1	Structural, free-cutting, case hardened and heat-treated steels, non-alloy	< 700	80	40	0.150
	P1.2	Structural, free-cutting, case hardened and heat-treated steels, non-alloy	< 1200	70	35	0.150

DZ-HP425

MMG*	Workpiece material	Strength/hardness [N/mm ²] [HRC]	Cutting speed v _c (m/min)		Feed f _z (mm/z)		
			Internal cooling	External cooling			
P P2	P2.1	Nitrided, case hardened and heat-treated steels, alloy	< 900	100	50	0.150	
	P2.2	Nitrided, case hardened and heat-treated steels, alloy	< 1400	80	40	0.150	
	P3	P3.1	Tool, bearing, spring and high-speed steels**	< 900	100	50	0.150
		P3.2	Tool, bearing, spring and high-speed steels**	< 1500	80	40	0.150
	P5	P5.1	Cast steel		80	40	0.150

DZ-HP016

MMG*	Workpiece material	Strength/hardness [N/mm ²] [HRC]	Cutting speed v _c (m/min)		Feed f _z (mm/z)	
			Internal cooling	External cooling		
P P4	P4.1	Stainless steels, ferritic and martensitic		50	25	0.120
	P6	P6.1	Stainless cast steel, ferritic and martensitic	40	20	0.120
M M1	M1.1	Stainless steels, austenitic	< 700	50	25	0.120
	M1.2	Stainless steels, ferritic/austenitic (duplex)	< 1000	30	15	0.120
	M2	M2.1	Stainless/heat-resistant cast steel, austenitic	< 700	50	25
M3	M3.1	Stainless cast steel, ferritic/austenitic (duplex)	< 1000	30	15	0.120

DZ-HC418

MMG*	Workpiece material	Strength/hardness [N/mm ²] [HRC]	Cutting speed v _c (m/min)		Feed f _z (mm/z)	
			Internal cooling	External cooling		
K K1	K1.1	Cast iron with lamellar graphite (grey cast iron), GJL	< 300	100	50	0.150

* MAPAL machining groups

** If the alloy parts Cr, Mo, Ni, V, W in total > 8% then select the next highest MAPAL machining group.

DZ-HP426

MMG*	Workpiece material	Strength/hardness [N/mm ²] [HRC]	Cutting speed v _c (m/min)		Feed f _z (mm/z)
			Internal cooling	External cooling	
K2	K2.1 Cast iron with spheroidal graphite, GJS	< 500	100	50	0.150
	K2.2 Cast iron with spheroidal graphite, GJS	≤ 800	90	45	0.150
	K2.3 Cast iron with spheroidal graphite, GJS	> 800	80	40	0.150
K3	K3.1 Cast iron with spheroidal graphite, GJV; malleable cast iron, GJM	< 500	70	35	0.150
	K3.2 Cast iron with spheroidal graphite, GJV; malleable cast iron, GJM	> 500	70	35	0.150

DZ-HP612

MMG*	Workpiece material	Strength/hardness [N/mm ²] [HRC]	Cutting speed v _c (m/min)		Feed f _z (mm/z)
			Internal cooling	External cooling	
N N1	N1.1 Aluminium, non-alloy and alloy < 3 % Si		160	80	0.150
	N1.2 Aluminium, alloy ≤ 7 % Si		160	80	0.150

DZ-HU615

MMG*	Workpiece material	Strength/hardness [N/mm ²] [HRC]	Cutting speed v _c (m/min)		Feed f _z (mm/z)
			Internal cooling	External cooling	
N N2	N2.1 Copper, unalloyed and low-alloyed	< 300	100	50	0.150
	N2.2 Copper, alloy	> 300	100	50	0.150
	N2.3 Brass, bronze, gunmetal	< 1200	100	50	0.150
S S1 S2	S1.1 Titanium, titanium alloys	< 400	30	15	0.120
	S2.1 Titanium, titanium alloys	< 1200	20	10	0.120
	S2.2 Titanium, titanium alloys	> 1200	20	10	0.100

DZ-HP016

MMG*	Workpiece material	Strength/hardness [N/mm ²] [HRC]	Cutting speed v _c (m/min)		Feed f _z (mm/z)
			Internal cooling	External cooling	
H H1 H1.1	Hardened steel / cast steel	45-55	30	15	0.12

The specified cutting values are guide values.

The optimum data for the respective machining task should be determined during the test or machining.

Cutting data recommendation for indexable inserts with DZ lead

Feed and cutting speed

DZ-CP122

MMG*		Workpiece material	Strength/hardness [N/mm ²] [HRC]	Cutting speed v _c (m/min)		Feed f _z (mm/z)	
				Internal cooling	External cooling		
P	P1	P1.1	Structural, free-cutting, case hardened and heat-treated steels, non-alloy	< 700	180	80	0.150
		P1.2	Structural, free-cutting, case hardened and heat-treated steels, non-alloy	< 1200	160	80	0.120
	P2	P2.1	Nitrided, case hardened and heat-treated steels, alloy	< 900	160	80	0.150
		P2.2	Nitrided, case hardened and heat-treated steels, alloy	< 1400	140	70	0.120
	P3	P3.1	Tool, bearing, spring and high-speed steels**	< 800	160	80	0.150
		P3.2	Tool, bearing, spring and high-speed steels**	< 1000	160	80	0.150
		P3.3	Tool, bearing, spring and high-speed steels**	< 1500	140	70	0.120
	P5	P5.1	Cast steel		140	70	0.120

DZ-PU620

MMG*		Workpiece material	Strength/hardness [N/mm ²] [HRC]	Cutting speed v _c (m/min)		Feed f _z (mm/z)	
				Internal cooling	External cooling		
N	N1	N1.1	Aluminium, non-alloy and alloy < 3 % Si		230	150	0.15
		N1.2	Aluminium, alloy ≤ 7 % Si		230	150	0.15
		N1.3	Aluminium, alloy > 7-12 % Si		230	150	0.15
		N1.4	Aluminium, alloy > 12 % Si		230	150	0.15
	N2	N2.1	Copper, unalloyed and low-alloyed	< 300	180	90	0.15
		N2.2	Copper, alloy	> 300	180	90	0.15
		N2.3	Brass, bronze, gunmetal	< 1200	180	90	0.15

DZ-FU485

MMG*		Workpiece material	Strength/hardness [N/mm ²] [HRC]	Cutting speed v _c (m/min)		Feed f _z (mm/z)	
				Internal cooling	External cooling		
K	K1	K1.1	Cast iron with lamellar graphite (grey cast iron), GJL	< 300	150	75	0.150

DZ-FU801

MMG*		Workpiece material	Strength/hardness [N/mm ²] [HRC]	Cutting speed v _c (m/min)		Feed f _z (mm/z)	
				Internal cooling	External cooling		
H	H1	H1.1	Hardened steel / cast steel	45-55	60	30	0.100
		H1.2	Hardened steel / cast steel	55-64	50	25	0.080

* MAPAL machining groups

** If the alloy parts Cr, Mo, Ni, V, W in total > 8% then select the next highest MAPAL machining group.

Cutting data recommendation for indexable inserts with EK lead

Feed and cutting speed

EK-HP115

MMG*	Workpiece material	Strength/hardness [N/mm ²] [HRC]	Cutting speed v _c (m/min)		Feed f _z (mm/z)	
			Internal cooling	External cooling		
P P1	P1.1	Structural, free-cutting, case hardened and heat-treated steels, non-alloy	< 700	80	40	0.150
	P1.2	Structural, free-cutting, case hardened and heat-treated steels, non-alloy	< 1200	70	35	0.150

EK-HP425

MMG*	Workpiece material	Strength/hardness [N/mm ²] [HRC]	Cutting speed v _c (m/min)		Feed f _z (mm/z)		
			Internal cooling	External cooling			
P P2	P2.1	Nitrided, case hardened and heat-treated steels, alloy	< 900	100	50	0.150	
	P2.2	Nitrided, case hardened and heat-treated steels, alloy	< 1400	80	40	0.150	
	P3	P3.1	Tool, bearing, spring and high-speed steels**	< 900	100	50	0.150
		P3.2	Tool, bearing, spring and high-speed steels**	< 1500	80	40	0.150
	P5	P5.1	Cast steel		80	40	0.150

EK-HP016

MMG*	Workpiece material	Strength/hardness [N/mm ²] [HRC]	Cutting speed v _c (m/min)		Feed f _z (mm/z)		
			Internal cooling	External cooling			
P4	P4.1	Stainless steels, ferritic and martensitic		50	25	0.120	
	P6	P6.1	Stainless cast steel, ferritic and martensitic	40	20	0.120	
M	M1	M1.1	Stainless steels, austenitic	< 700	50	25	0.120
		M1.2	Stainless steels, ferritic/austenitic (duplex)	< 1000	30	15	0.120
	M2	M2.1	Stainless/heat-resistant cast steel, austenitic	< 700	50	25	0.120
		M3	M3.1	Stainless cast steel, ferritic/austenitic (duplex)	< 1000	30	15

EK-HP612

MMG*	Workpiece material	Strength/hardness [N/mm ²] [HRC]	Cutting speed v _c (m/min)		Feed f _z (mm/z)	
			Internal cooling	External cooling		
N N1	N1.1	Aluminium, non-alloy and alloy < 3 % Si		160	80	0.15
	N1.2	Aluminium, alloy ≤ 7 % Si		160	80	0.15

The specified cutting values are guide values.

The optimum data for the respective machining task should be determined during the test or machining.

Cutting data recommendation for indexable inserts with EK lead

Feed and cutting speed

EK-HU615

MMG*		Workpiece material	Strength/hardness [N/mm ²] [HRC]	Cutting speed v _c (m/min)		Feed f _z (mm/z)
				Internal cooling	External cooling	
N	N2.1	Copper, unalloyed and low-alloyed	< 300	100	50	0.150
	N2.2	Copper, alloy	> 300	100	50	0.150
	N2.3	Brass, bronze, gunmetal	< 1200	100	50	0.150
S	S1.1	Titanium, titanium alloys	< 400	30	15	0.120
	S2.1	Titanium, titanium alloys	< 1200	20	10	0.120
	S2.2	Titanium, titanium alloys	> 1200	20	10	0.100

EK-CP122

MMG*		Workpiece material	Strength/hardness [N/mm ²] [HRC]	Cutting speed v _c (m/min)		Feed f _z (mm/z)
				Internal cooling	External cooling	
P1	P1.1	Structural, free-cutting, case hardened and heat-treated steels, non-alloy	< 700	180	90	0.150
	P1.2	Structural, free-cutting, case hardened and heat-treated steels, non-alloy	< 1200	160	80	0.120
P2	P2.1	Nitrided, case hardened and heat-treated steels, alloy	< 900	160	80	0.150
	P2.2	Nitrided, case hardened and heat-treated steels, alloy	< 1400	140	70	0.120
P3	P3.1	Tool, bearing, spring and high-speed steels**	< 800	160	80	0.150
	P3.2	Tool, bearing, spring and high-speed steels**	< 1000	160	80	0.150
	P3.3	Tool, bearing, spring and high-speed steels**	< 1500	140	70	0.120
P5	P5.1	Cast steel		140	70	0.120

EK-PU620

MMG*		Workpiece material	Strength/hardness [N/mm ²] [HRC]	Cutting speed v _c (m/min)		Feed f _z (mm/z)
				Internal cooling	External cooling	
N	N1	N1.1	Aluminium, non-alloy and alloy < 3 % Si	230	115	0.150
		N1.2	Aluminium, alloy ≤ 7 % Si	230	115	0.150
		N1.3	Aluminium, alloy > 7-12 % Si	230	115	0.150
		N1.4	Aluminium, alloy > 12 % Si	230	115	0.150
N	N2	N2.1	Copper, unalloyed and low-alloyed	< 300	180	90
		N2.2	Copper, alloy	> 300	180	90
		N2.3	Brass, bronze, gunmetal	< 1200	180	90

* MAPAL machining groups

** If the alloy parts Cr, Mo, Ni, V, W in total > 8% then select the next highest MAPAL machining group.

Cutting data recommendation for indexable inserts with SZ lead

Feed and cutting speed

SZ-HP612

MMG*		Workpiece material	Strength/hardness [N/mm ²] [HRC]	Cutting speed v _c (m/min)		Feed f _z (mm/z)
				Internal cooling	External cooling	
N	N1	N1.1 Aluminium, non-alloy and alloy < 3 % Si		160	80	0.120
	N1.2 Aluminium, alloy ≤ 7 % Si		160	80	0.120	

SZ-HU615

MMG*		Workpiece material	Strength/hardness [N/mm ²] [HRC]	Cutting speed v _c (m/min)		Feed f _z (mm/z)
				Internal cooling	External cooling	
N2	N2.1	Copper, unalloyed and low-alloyed	< 300	100	50	0.120
	N2.2	Copper, alloy	> 300	100	50	0.120
	N2.3	Brass, bronze, gunmetal	< 1200	100	50	0.120

SZ-PU620

MMG*		Workpiece material	Strength/hardness [N/mm ²] [HRC]	Cutting speed v _c (m/min)		Feed f _z (mm/z)	
				Internal cooling	External cooling		
N	N1	N1.1 Aluminium, non-alloy and alloy < 3 % Si		230	115	0.120	
		N1.2 Aluminium, alloy ≤ 7 % Si		230	115	0.120	
		N1.3 Aluminium, alloy > 7-12 % Si		230	115	0.120	
		N1.4 Aluminium, alloy > 12 % Si		230	115	0.120	
	N2	N2.1	Copper, unalloyed and low-alloyed	< 300	180	90	0.120
		N2.2	Copper, alloy	> 300	180	90	0.120
		N2.3	Brass, bronze, gunmetal	< 1200	180	90	0.120

The specified cutting values are guide values.

The optimum data for the respective machining task should be determined during the test or machining.

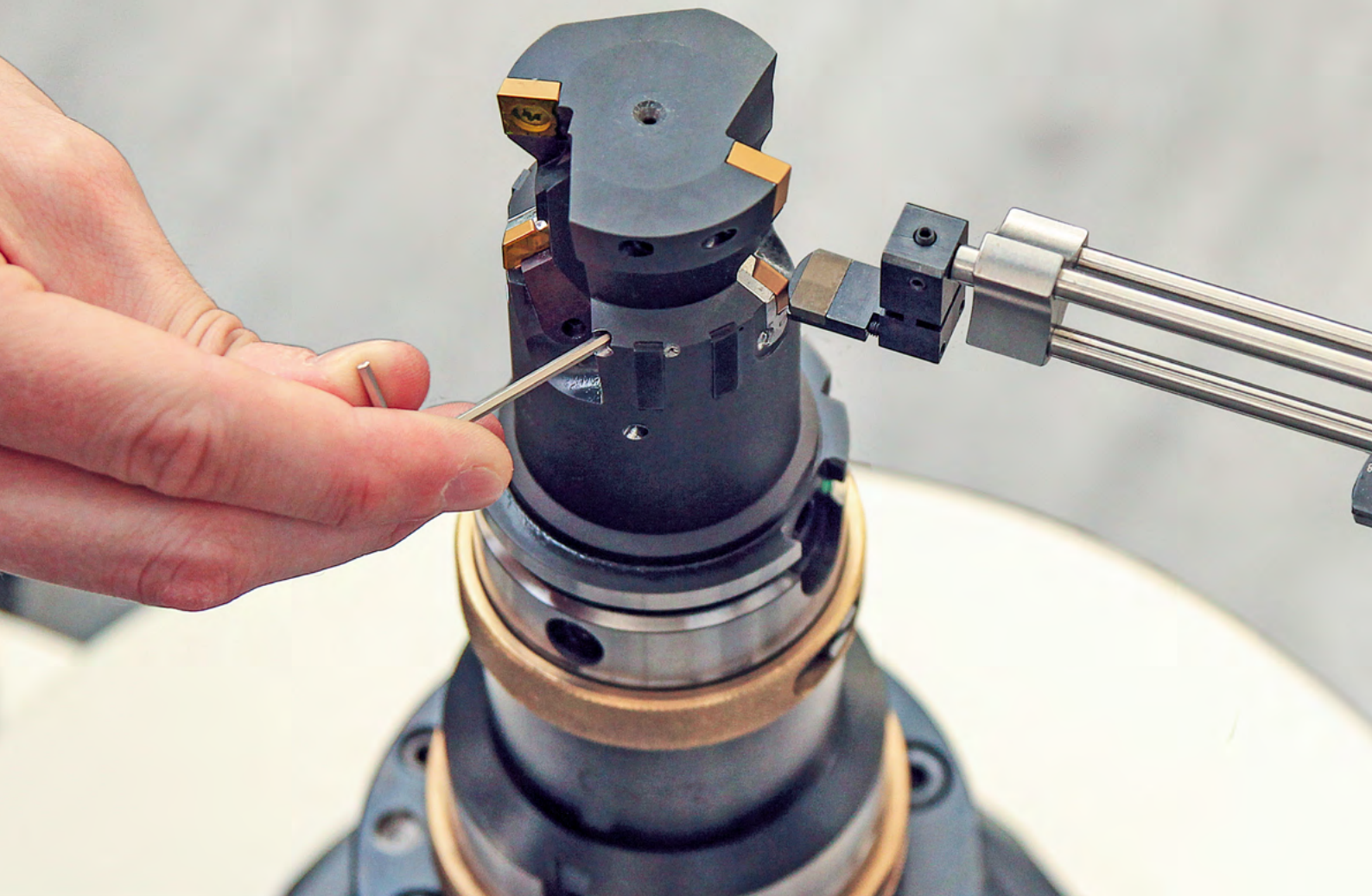

EasyAdjust System

Quick and easy tool adjustment

When developing the EasyAdjust system, the goal was to drastically reduce the setting effort for tools with guide pad technology.

At the heart of the EasyAdjust system is an innovative cassette that holds the six- or four-edged inserts securely and free from unwanted movement. The back taper of the minor cutting edge is already integrated into this cassette, thus eliminated the need for this adjustment.

Due to the exact guidance of the cassette on a precision guide pin, the back taper remains unchanged even during diameter settings. The appropriate cassettes are available for differ-

ent back tapers. They can be selected and used depending on the application – independent of the indexable insert and tool.

Significant benefits for economic efficiency

This system boosts economic efficiency while on the job: The HX indexable inserts with six useful cutting edges can be inserted quickly and precisely in cassettes with different back tapers. Tools with the EasyAdjust system only have to be adjusted in diameter. That increases process reliability while changing blades. An effect that becomes all the more significant, the more blades are installed in a tool. The setting effort per blade is reduced to a fraction by this new development.

ADVANTAGES

- Setting effort drastically reduced
- Tools only have to be adjusted in diameter
- Cost-effectiveness, handling and process reliability significantly increased compared to tools with guide pads without the EA system
- Precision remains high

System overview

The EasyAdjust system in detail

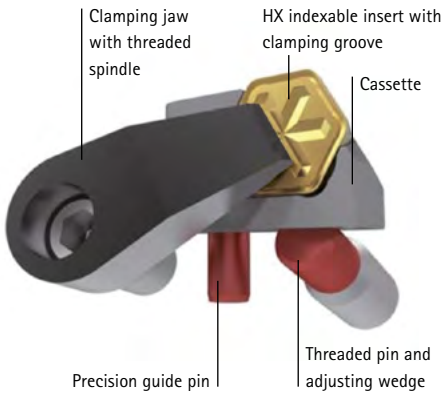

The EasyAdjust system consists of a precision cassette which holds the indexable insert. A precision guide pin guides the cassette during adjustment. A clamping groove together with the clamping jaw form a stable, force-closure system, which ensures that the indexable insert is securely retained.

Tools with the EasyAdjust system only have to be adjusted in diameter. The back taper is already integrated into the cassette and remains unchanged if the diameter is altered.

ADVANTAGES

- Setting time reduced by half
- Exact guidance of the system on precision guide pin
- Back taper already integrated into the cassette
- Optimum cutting material utilisation thanks to indexable insert with four and six cutting edges

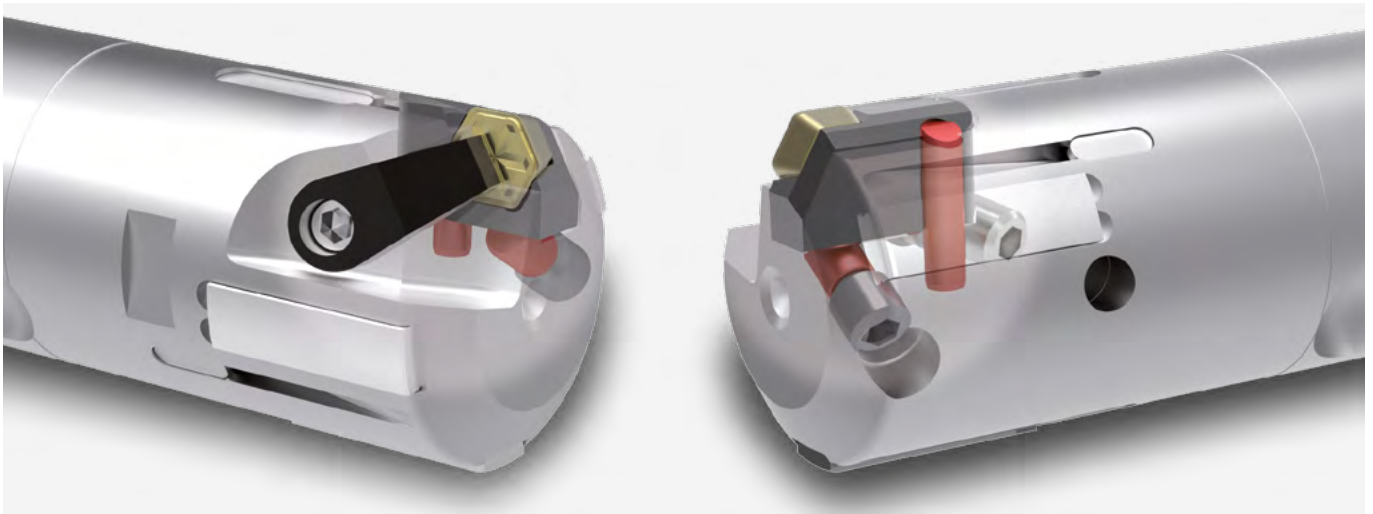

Comparison of the setting times

The setting effort per cutting edge is drastically reduced thanks to the EasyAdjust system.

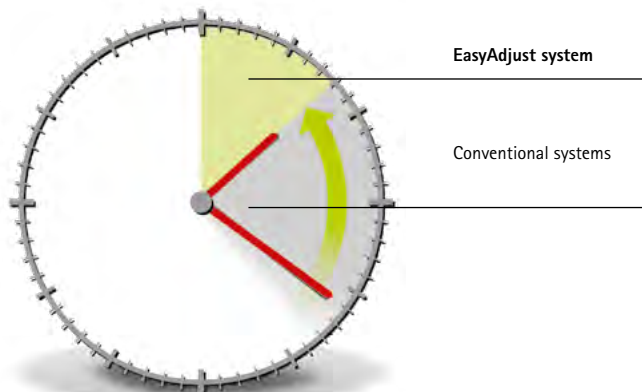

Back taper

The back taper on the insert has a major influence on the bore quality. MAPAL selects the back taper of the cassette necessary for the machining task according to the demands of the material and the feed rate.

ADVANTAGES
- Adaptation of the back taper, irrespective of indexable insert and tool body
- Production of defined roughness thanks to different back tapers
- Optimal surface finish for downstream processes (for example honing)

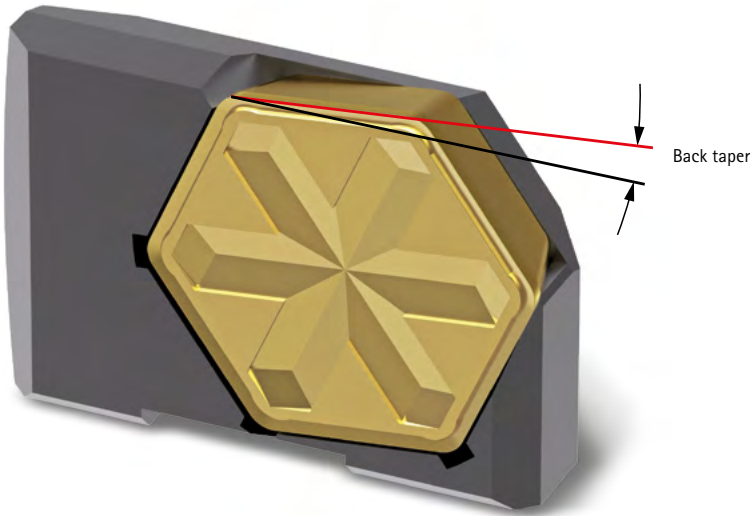

Two variants of the indexable inserts

The EasyAdjust system is available with two different insert types for through bores and blind bores:

HX indexable inserts

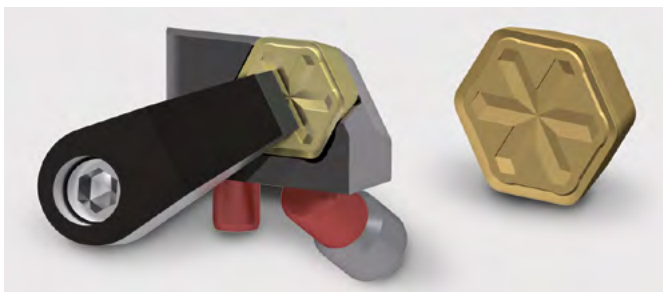

HX indexable inserts with six cutting edges for through bores.

TEC indexable inserts

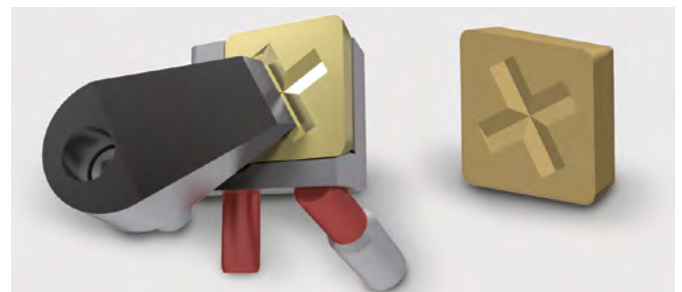

TEC indexable inserts with four cutting edges and different lead geometries for blind bores and face shoulder machining.



Through bore

Suitable for open bores. Not suitable for shoulder machining if 90° are required.





Blind bore and face shoulder bore

Suitable for closed bores and shoulder machining, taking the cutting edge length into account.

Article overview







EasyAdjust system with HX indexable inserts

Selection criteria					Insert type
Type of bore	∅ range tool		Graduation of the back taper*		
Through bore 	from ∅ 20	B	Particular demands	Back taper ↓ - + ↓	HX 
		D	Recommended standard		
		F	Particular demands		
		H			
		K			
		M			
		P			
		R			
	from ∅ 30	B	Particular demands	Back taper ↓ - + ↓	
		D	Recommended standard		
		F	Particular demands		
		H			
		K			
		R			



EasyAdjust system with TEC indexable inserts

Selection criteria					Insert type
Type of bore	∅ range tool		Graduation of the back taper*		
Blind bore / face shoulder bore  	from ∅ 20	B	Particular demands	Back taper ↓ - + ↓	TEC 
		D	Recommended standard		
		F	Particular demands		
		H			
		K			
		M			
		P			
		R			
	from ∅ 30	B	Particular demands	Back taper ↓ - + ↓	
		D	Recommended standard		
		F	Particular demands		
		H			
		K			
		R			

Dimensions in mm.

For suitable indexable insert, see page 518.

* Selection by agreement with MAPAL, depending on the demands of the part.

Note:

When changing the system, it is essential to note that the cassette and clamping plate must be adapted accordingly.

HX indexable inserts for bore machining

For tools with guide pads

Cutting material			Carbide							
MMG*	P			M	K		N			
	1.1 - 1.2	2 - 3 5	4 6	1 - 3	1.1	2 - 3	1.1 - 1.2	2.3	2.1 - 2.2	
Cutting material type			HP342	HP122	HP018	HP018	HC419	HP122	HP612	HU612

Chip form geometry.	Size	Lead	Specification	Order no.							
negative	2	R0,8	WP-K1288-2133-...								
	3	R0,8	WP-K1288-2123-...								
neutral	2	R0,8	WP-606087689-...					30688944			
	3	R0,8	WP-606087714-...					30688981			
positive	2	R0,8	WP-HX228RL-...	30685704	30197811	31100892	31100892		30197811		30320977
	3	R0,8	WP-HX238RL-...	30685705	30669024	31100893	31100893		30669024		30669021
highly positive	2	R0,8	WP-HX128RL-...							30685707	30669011
	3	R0,8	WP-HX138RL-...							30685708	30669015



Carbide		
S		H
1 - 2		1.1
HU612		HP018
Order no.		
		31100892
		31100893
		30669011
		30669015

Cermet	
P	
1 - 3 5	
CP122	
Order no.	
	30222667
	30222666

PCD	
N	
1 - 2	
PU620	
Order no.	
	31290969**
	31290980**

PcBN		
K	H	
1.1		1.1 - 1.2
FU485		FU801
Order no.		
30009396**		30033403**
30008170**		30097476**

For cutting data recommendations, see end of chapter.
Cutting edges with special lead available on request.

TEC indexable inserts for bore machining

For tools with guide pads

Cutting material	Carbide									
MMG*	P			M		K		N		
	1.1 - 1.2	2 - 3 5	4 6	1 - 3		1.1	2 - 3	1.1 - 1.2	2.3	2.1 - 2.2
Cutting material type	HP115	HP425	HP016	HP016	HC418	HP426	HP612	HU615		

Chip form geometry.	Size	Lead	Specification	Order no.												
negative	2	AS	WP-TEC2-ASS35R0A-...													
		** EK	WP-TEC2-EKS35R0A-...													
		DZ	WP-TEC2-DZS35R0A-...													
		** R0,4	WP-TEC2-04S35R0A-...													

neutral	2	AS	WP-TEC2-ASE02R0A-...													
		** EK	WP-TEC2-EKE02R0A-...													
		DZ	WP-TEC2-DZE02R0A-...							31306739						
		** R0,4	WP-TEC2-04E02R0A-...							31306750						

positive	2	AS	WP-TEC2-ASF01R1G-...	31099198	30953115	31099199	31099199						31306751			
		** EK	WP-TEC2-EKF01R1G-...	31306755	31306756	31306758	31306758							31306761		
		DZ	WP-TEC2-DZF01R1G-...	31306854	31100514	31100517	31100517				31306855			31306857		
		** R0,4	WP-TEC2-04F01R1J-...	31306873	31306875	31306876	31306876				31306878			31306879		

highly positive	2	AS	WP-TEC2-ASF01R1N-...										31306883		31306887
		** EK	WP-TEC2-EKF01R1N-...										31306903		31306904
		DZ	WP-TEC2-DZF01R1N-...										31306907		31306920
		** R0,4	WP-TEC2-04F01R1U-...										30685231		31306921

** Note: Only use EK and R0.4 leads for blind bores machining and component-related face machining.

* MAPAL machining groups.



Carbide		
S		H
1 - 2		1.1
HU615		HP016

Order no.		

		31100517
		31306876

	31306887	
	31306904	
	31306920	
	31306921	

Cermet	
P	
1 - 3 5	
CP122	

Order no.	

	31306753
	31306762
	31306870
	31306880

PCD	
N	
1 - 2	
PU620	

Order no.	

	31306754**
	31306763**
	31306871**
	30823892**

PcBN		
K		H
1.1		1.1 - 1.2
FU485		FU801

Order no.		
	31306734**	31306735**
	30539027**	30688967**

Accessories for EasyAdjust system



TEC cutting edge size	Blade cassettes for EasyAdjust system		Clamping plates for EasyAdjust system	
	Specification	Order no.	Specification	Order no.
2	BC-EAS-R-42-B	30546828	CP-EAS-R-N2-B	30508276
2	BC-EAS-R-42-D	30498068	CP-EAS-R-N2-D	30561484
2	BC-EAS-R-42-F	30503101	CP-EAS-R-N2-F	30561485
2	BC-EAS-R-42-H	30503104	CP-EAS-R-N2-H	30561487
2	BC-EAS-R-42-K	30546837	CP-EAS-R-N2-K	30561488
2	BC-EAS-R-42-M	30546839	CP-EAS-R-N2-M	30561489
2	BC-EAS-R-42-P	30546840	CP-EAS-R-N2-P	30561490
2	BC-EAS-R-42-R	30546841	CP-EAS-R-N2-R	30508277
3	BC-EAS-R-43-B	30546844	CP-EAS-R-N3-B	30561492
3	BC-EAS-R-43-D	30498067	CP-EAS-R-N3-D	30561493
3	BC-EAS-R-43-F	30503115	CP-EAS-R-N3-F	30561494
3	BC-EAS-R-43-H	30503116	CP-EAS-R-N3-H	30561495
3	BC-EAS-R-43-K	30546845	CP-EAS-R-N3-K	30561496
3	BC-EAS-R-43-M	30546846	CP-EAS-R-N3-M	30561497
3	BC-EAS-R-43-P	30546848	CP-EAS-R-N3-P	30561498
3	BC-EAS-R-43-R	30546849	CP-EAS-R-N3-R	30561499

Note:

When changing the system, it is essential to note that the cassette and clamping plate must be adapted accordingly.



HX cutting edge size	Blade cassettes for EasyAdjust system		Clamping plates for EasyAdjust system	
	Specification	Order no.	Specification	Order no.
2	BC-EAS-R-62-B	30275903	CP-EAS-R-N2-B	30508276
2	BC-EAS-R-62-D	30410077	CP-EAS-R-N2-D	30561484
2	BC-EAS-R-62-F	30503094	CP-EAS-R-N2-F	30561485
2	BC-EAS-R-62-H	30503096	CP-EAS-R-N2-H	30561487
2	BC-EAS-R-62-K	30496821	CP-EAS-R-N2-K	30561488
2	BC-EAS-R-62-M	30471831	CP-EAS-R-N2-M	30561489
2	BC-EAS-R-62-P	30471833	CP-EAS-R-N2-P	30561490
2	BC-EAS-R-62-R	30496828	CP-EAS-R-N2-R	30508277
3	BC-EAS-R-63-B	30495992	CP-EAS-R-N3-B	30561492
3	BC-EAS-R-63-D	30469856	CP-EAS-R-N3-D	30561493
3	BC-EAS-R-63-F	30503097	CP-EAS-R-N3-F	30561494
3	BC-EAS-R-63-H	30503098	CP-EAS-R-N3-H	30561495
3	BC-EAS-R-63-K	30496827	CP-EAS-R-N3-K	30561496
3	BC-EAS-R-63-M	30471832	CP-EAS-R-N3-M	30561497
3	BC-EAS-R-63-P	30471834	CP-EAS-R-N3-P	30561498
3	BC-EAS-R-63-R	30496829	CP-EAS-R-N3-R	30561499

Cutting data recommendation for HX indexable inserts

Feed and cutting speed

HX-HP342

MMG*		Workpiece material	Strength/hardness [N/mm ²] [HRC]	Cutting speed v _c (m/min)		Feed f _z (mm/z)
				Internal cooling	External cooling	
P	P1	Structural, free-cutting, case hardened and heat-treated steels, non-alloy	< 700	80	40	0.150
	P1.2	Structural, free-cutting, case hardened and heat-treated steels, non-alloy	< 1200	70	35	0.150

HX-HP122

MMG*		Workpiece material	Strength/hardness [N/mm ²] [HRC]	Cutting speed v _c (m/min)		Feed f _z (mm/z)
				Internal cooling	External cooling	
P	P2	Nitrided, case hardened and heat-treated steels, alloy	< 900	100	50	0.150
	P2.2	Nitrided, case hardened and heat-treated steels, alloy	< 1400	80	40	0.150
	P3	Tool, bearing, spring and high-speed steels**	< 900	100	50	0.150
	P3.2	Tool, bearing, spring and high-speed steels**	< 1500	80	40	0.150
	P5	P5.1	Cast steel		80	40

HX-HP018

MMG*		Workpiece material	Strength/hardness [N/mm ²] [HRC]	Cutting speed v _c (m/min)		Feed f _z (mm/z)
				Internal cooling	External cooling	
P	P4	P4.1	Stainless steels, ferritic and martensitic	50	25	0.120
	P6	P6.1	Stainless cast steel, ferritic and martensitic	40	20	0.120
M	M1	M1.1	Stainless steels, austenitic	50	25	0.120
		M1.2	Stainless steels, ferritic/austenitic (duplex)	30	15	0.120
	M2	M2.1	Stainless/heat-resistant cast steel, austenitic	50	25	0.120
		M3	M3.1	Stainless cast steel, ferritic/austenitic (duplex)	30	15

HX-HC419

MMG*		Workpiece material	Strength/hardness [N/mm ²] [HRC]	Cutting speed v _c (m/min)		Feed f _z (mm/z)
				Internal cooling	External cooling	
K	K1	K1.1	Cast iron with lamellar graphite (grey cast iron), GJL	110	55	0.150

* MAPAL machining groups

** If the alloy parts Cr, Mo, Ni, V, W in total > 8% then select the next highest MAPAL machining group.

HX-HP122

MMG*	Workpiece material	Strength/hardness [N/mm ²] [HRC]	Cutting speed v _c (m/min)		Feed f _z (mm/z)
			Internal cooling	External cooling	
K2	K2.1 Cast iron with spheroidal graphite, GJS	< 500	100	50	0.150
	K2.2 Cast iron with spheroidal graphite, GJS	≤ 800	90	45	0.150
	K2.3 Cast iron with spheroidal graphite, GJS	> 800	80	40	0.150
K3	K3.1 Cast iron with spheroidal graphite, GJV; malleable cast iron, GJM	< 500	70	35	0.150
	K3.2 Cast iron with spheroidal graphite, GJV; malleable cast iron, GJM	> 500	70	35	0.150

HX-HP612

MMG*	Workpiece material	Strength/hardness [N/mm ²] [HRC]	Cutting speed v _c (m/min)		Feed f _z (mm/z)
			Internal cooling	External cooling	
N N1	N1.1 Aluminium, non-alloy and alloy < 3 % Si		160	80	0.150
	N1.2 Aluminium, alloy ≤ 7 % Si		160	80	0.150

HX-HU612

MMG*	Workpiece material	Strength/hardness [N/mm ²] [HRC]	Cutting speed v _c (m/min)		Feed f _z (mm/z)
			Internal cooling	External cooling	
N N2	N2.1 Copper, unalloyed and low-alloyed	< 300	100	50	0.150
	N2.2 Copper, alloy	> 300	100	50	0.150
	N2.3 Brass, bronze, gunmetal	< 1200	100	50	0.150
S S1 S2	S1.1 Titanium, titanium alloys	< 400	30	15	0.120
	S2.1 Titanium, titanium alloys	< 1200	20	10	0.120
	S2.2 Titanium, titanium alloys	> 1200	20	10	0.100

HX-HP018

MMG*	Workpiece material	Strength/hardness [N/mm ²] [HRC]	Cutting speed v _c (m/min)		Feed f _z (mm/z)
			Internal cooling	External cooling	
H H1 H1.1	Hardened steel / cast steel	45-55	30	15	0.120

The specified cutting values are guide values.

The optimum data for the respective machining task should be determined during the test or machining.

Cutting data recommendation for HX indexable inserts

Feed and cutting speed

HX-CP122

MMG*		Workpiece material	Strength/hardness [N/mm ²] [HRC]	Cutting speed v _c (m/min)		Feed f _z (mm/z)	
				Internal cooling	External cooling		
P	P1	P1.1	Structural, free-cutting, case hardened and heat-treated steels, non-alloy	< 700	180	90	0.150
		P1.2	Structural, free-cutting, case hardened and heat-treated steels, non-alloy	< 1200	160	80	0.120
	P2	P2.1	Nitrided, case hardened and heat-treated steels, alloy	< 900	160	80	0.150
		P2.2	Nitrided, case hardened and heat-treated steels, alloy	< 1400	140	70	0.120
	P3	P3.1	Tool, bearing, spring and high-speed steels**	< 800	160	80	0.150
		P3.2	Tool, bearing, spring and high-speed steels**	< 1000	160	80	0.150
		P3.3	Tool, bearing, spring and high-speed steels**	< 1500	140	70	0.120
	P5	P5.1	Cast steel		140	70	0.120

HX-PU620

MMG*		Workpiece material	Strength/hardness [N/mm ²] [HRC]	Cutting speed v _c (m/min)		Feed f _z (mm/z)	
				Internal cooling	External cooling		
N	N1	N1.1	Aluminium, non-alloy and alloy < 3 % Si		230	115	0.150
		N1.2	Aluminium, alloy ≤ 7 % Si		230	115	0.150
		N1.3	Aluminium, alloy > 7-12 % Si		230	115	0.150
		N1.4	Aluminium, alloy > 12 % Si		230	115	0.150
	N2	N2.1	Copper, unalloyed and low-alloyed	< 300	180	90	0.150
		N2.2	Copper, alloy	> 300	180	90	0.150
		N2.3	Brass, bronze, gunmetal	< 1200	180	90	0.150

HX-FU485

MMG*		Workpiece material	Strength/hardness [N/mm ²] [HRC]	Cutting speed v _c (m/min)		Feed f _z (mm/z)	
				Internal cooling	External cooling		
K	K1	K1.1	Cast iron with lamellar graphite (grey cast iron), GJL	< 300	150	75	0.150

HX-FU801

MMG*		Workpiece material	Strength/hardness [N/mm ²] [HRC]	Cutting speed v _c (m/min)		Feed f _z (mm/z)	
				Internal cooling	External cooling		
H	H1	H1.1	Hardened steel / cast steel	45-55	60	30	0.100
		H1.2	Hardened steel / cast steel	55-64	50	25	0.080

* MAPAL machining groups

** If the alloy parts Cr, Mo, Ni, V, W in total > 8% then select the next highest MAPAL machining group.

Cutting data recommendation for indexable TEC indexable inserts

Feed and cutting speed

TEC2-AS-HP115

MMG*	Workpiece material	Strength/hardness [N/mm ²] [HRC]	Cutting speed v _c (m/min)		Feed f _z (mm/z)	
			Internal cooling	External cooling		
P P1	P1.1	Structural, free-cutting, case hardened and heat-treated steels, non-alloy	< 700	80	40	0.150
	P1.2	Structural, free-cutting, case hardened and heat-treated steels, non-alloy	< 1200	70	35	0.150

TEC2-EK-HP115

MMG*	Workpiece material	Strength/hardness [N/mm ²] [HRC]	Cutting speed v _c (m/min)		Feed f _z (mm/z)	
			Internal cooling	External cooling		
P P1	P1.1	Structural, free-cutting, case hardened and heat-treated steels, non-alloy	< 700	80	40	0.150
	P1.2	Structural, free-cutting, case hardened and heat-treated steels, non-alloy	< 1200	70	35	0.150

TEC2-DZ-HP115

MMG*	Workpiece material	Strength/hardness [N/mm ²] [HRC]	Cutting speed v _c (m/min)		Feed f _z (mm/z)	
			Internal cooling	External cooling		
P P1	P1.1	Structural, free-cutting, case hardened and heat-treated steels, non-alloy	< 700	80	40	0.150
	P1.2	Structural, free-cutting, case hardened and heat-treated steels, non-alloy	< 1200	70	35	0.150

TEC2-04-HP115

MMG*	Workpiece material	Strength/hardness [N/mm ²] [HRC]	Cutting speed v _c (m/min)		Feed f _z (mm/z)	
			Internal cooling	External cooling		
P P1	P1.1	Structural, free-cutting, case hardened and heat-treated steels, non-alloy	< 700	80	40	0.150
	P1.2	Structural, free-cutting, case hardened and heat-treated steels, non-alloy	< 1200	70	35	0.150

TEC2-AS-HP425

MMG*	Workpiece material	Strength/hardness [N/mm ²] [HRC]	Cutting speed v _c (m/min)		Feed f _z (mm/z)	
			Internal cooling	External cooling		
P P2 P3 P5	P2.1	Nitrided, case hardened and heat-treated steels, alloy	< 900	100	50	0.150
	P2.2	Nitrided, case hardened and heat-treated steels, alloy	< 1400	80	40	0.150
	P3.1	Tool, bearing, spring and high-speed steels**	< 900	100	50	0.150
	P3.2	Tool, bearing, spring and high-speed steels**	< 1500	80	40	0.150
	P5.1	Cast steel		80	40	0.150

The specified cutting values are guide values.

The optimum data for the respective machining task should be determined during the test or machining.

Cutting data recommendation for TEC indexable inserts

Feed and cutting speed

TEC2-EK-HP425

MMG*		Workpiece material	Strength/hardness [N/mm ²] [HRC]	Cutting speed v _c (m/min)		Feed f _z (mm/z)
				Internal cooling	External cooling	
P	P2.1	Nitrided, case hardened and heat-treated steels, alloy	< 900	100	50	0.150
	P2.2	Nitrided, case hardened and heat-treated steels, alloy	< 1400	80	40	0.150
	P3.1	Tool, bearing, spring and high-speed steels**	< 900	100	50	0.150
	P3.2	Tool, bearing, spring and high-speed steels**	< 1500	80	40	0.150
	P5.1	Cast steel		80	40	0.150

TEC2-DZ-HP425

MMG*		Workpiece material	Strength/hardness [N/mm ²] [HRC]	Cutting speed v _c (m/min)		Feed f _z (mm/z)
				Internal cooling	External cooling	
P	P2.1	Nitrided, case hardened and heat-treated steels, alloy	< 900	100	50	0.150
	P2.2	Nitrided, case hardened and heat-treated steels, alloy	< 1400	80	40	0.150
	P3.1	Tool, bearing, spring and high-speed steels**	< 900	100	50	0.150
	P3.2	Tool, bearing, spring and high-speed steels**	< 1500	80	40	0.150
	P5.1	Cast steel		80	40	0.150

TEC2-04-HP425

MMG*		Workpiece material	Strength/hardness [N/mm ²] [HRC]	Cutting speed v _c (m/min)		Feed f _z (mm/z)
				Internal cooling	External cooling	
P	P2.1	Nitrided, case hardened and heat-treated steels, alloy	< 900	100	50	0.150
	P2.2	Nitrided, case hardened and heat-treated steels, alloy	< 1400	80	40	0.150
	P3.1	Tool, bearing, spring and high-speed steels**	< 900	100	50	0.150
	P3.2	Tool, bearing, spring and high-speed steels**	< 1500	80	40	0.150
	P5.1	Cast steel		80	40	0.150

TEC2-AS-HP016

MMG*		Workpiece material	Strength/hardness [N/mm ²] [HRC]	Cutting speed v _c (m/min)		Feed f _z (mm/z)
				Internal cooling	External cooling	
P	P4.1	Stainless steels, ferritic and martensitic		50	25	0.120
	P6.1	Stainless cast steel, ferritic and martensitic		40	20	0.120
M	M1.1	Stainless steels, austenitic	< 700	50	25	0.120
	M1.2	Stainless steels, ferritic/austenitic (duplex)	< 1000	30	15	0.120
	M2.1	Stainless/heat-resistant cast steel, austenitic	< 700	50	25	0.120
M3	M3.1	Stainless cast steel, ferritic/austenitic (duplex)	< 1000	30	15	0.120

* MAPAL machining groups

** If the alloy parts Cr, Mo, Ni, V, W in total > 8% then select the next highest MAPAL machining group.

TEC2-EK-HP016

MMG*		Workpiece material	Strength/hardness [N/mm ²] [HRC]	Cutting speed v _c (m/min)		Feed f _z (mm/z)	
				Internal cooling	External cooling		
P4	P4.1	Stainless steels, ferritic and martensitic		50	25	0.120	
	P6.1	Stainless cast steel, ferritic and martensitic		40	20	0.120	
M	M1	M1.1	Stainless steels, austenitic	< 700	50	25	0.120
		M1.2	Stainless steels, ferritic/austenitic (duplex)	< 1000	30	15	0.120
	M2	M2.1	Stainless/heat-resistant cast steel, austenitic	< 700	50	25	0.120
	M3	M3.1	Stainless cast steel, ferritic/austenitic (duplex)	< 1000	30	15	0.120

TEC2-DZ-HP016

MMG*		Workpiece material	Strength/hardness [N/mm ²] [HRC]	Cutting speed v _c (m/min)		Feed f _z (mm/z)	
				Internal cooling	External cooling		
P4	P4.1	Stainless steels, ferritic and martensitic		50	25	0.120	
	P6.1	Stainless cast steel, ferritic and martensitic		40	20	0.120	
M	M1	M1.1	Stainless steels, austenitic	< 700	50	25	0.120
		M1.2	Stainless steels, ferritic/austenitic (duplex)	< 1000	30	15	0.120
	M2	M2.1	Stainless/heat-resistant cast steel, austenitic	< 700	50	25	0.120
	M3	M3.1	Stainless cast steel, ferritic/austenitic (duplex)	< 1000	30	15	0.120

TEC2-04-HP016

MMG*		Workpiece material	Strength/hardness [N/mm ²] [HRC]	Cutting speed v _c (m/min)		Feed f _z (mm/z)	
				Internal cooling	External cooling		
P4	P4.1	Stainless steels, ferritic and martensitic		50	25	0.120	
	P6.1	Stainless cast steel, ferritic and martensitic		40	20	0.120	
M	M1	M1.1	Stainless steels, austenitic	< 700	50	25	0.120
		M1.2	Stainless steels, ferritic/austenitic (duplex)	< 1000	30	15	0.120
	M2	M2.1	Stainless/heat-resistant cast steel, austenitic	< 700	50	25	0.120
	M3	M3.1	Stainless cast steel, ferritic/austenitic (duplex)	< 1000	30	15	0.120

TEC2-DZ-HC418

MMG*		Workpiece material	Strength/hardness [N/mm ²] [HRC]	Cutting speed v _c (m/min)		Feed f _z (mm/z)	
				Internal cooling	External cooling		
K	K1	K1.1	Cast iron with lamellar graphite (grey cast iron), GJL	< 300	100	50	0.150

The specified cutting values are guide values.

The optimum data for the respective machining task should be determined during the test or machining.

Cutting data recommendation for TEC indexable inserts

Feed and cutting speed

TEC2-04-HC418

MMG*	Workpiece material	Strength/hardness [N/mm ²] [HRC]	Cutting speed v _c (m/min)		Feed f _z (mm/z)
			Internal cooling	External cooling	
K K1 K1.1	Cast iron with lamellar graphite (grey cast iron), GJL	< 300	100	50	0.150

TEC2-DZ-HP426

MMG*	Workpiece material	Strength/hardness [N/mm ²] [HRC]	Cutting speed v _c (m/min)		Feed f _z (mm/z)
			Internal cooling	External cooling	
K2	K2.1 Cast iron with spheroidal graphite, GJS	< 500	100	50	0.150
	K2.2 Cast iron with spheroidal graphite, GJS	≤ 800	90	45	0.150
	K2.3 Cast iron with spheroidal graphite, GJS	> 800	80	40	0.150
K3	K3.1 Cast iron with spheroidal graphite, GJV; malleable cast iron, GJM	< 500	70	35	0.150
	K3.2 Cast iron with spheroidal graphite, GJV; malleable cast iron, GJM	> 500	70	35	0.150

TEC2-04-HP426

MMG*	Workpiece material	Strength/hardness [N/mm ²] [HRC]	Cutting speed v _c (m/min)		Feed f _z (mm/z)
			Internal cooling	External cooling	
K2	K2.1 Cast iron with spheroidal graphite, GJS	< 500	100	50	0.150
	K2.2 Cast iron with spheroidal graphite, GJS	≤ 800	90	45	0.150
	K2.3 Cast iron with spheroidal graphite, GJS	> 800	80	40	0.150
K3	K3.1 Cast iron with spheroidal graphite, GJV; malleable cast iron, GJM	< 500	70	35	0.150
	K3.2 Cast iron with spheroidal graphite, GJV; malleable cast iron, GJM	> 500	70	35	0.150

TEC2-AS-HP612

MMG*	Workpiece material	Strength/hardness [N/mm ²] [HRC]	Cutting speed v _c (m/min)		Feed f _z (mm/z)
			Internal cooling	External cooling	
N N1	N1.1 Aluminium, non-alloy and alloy < 3 % Si		160	80	0.150
	N1.2 Aluminium, alloy ≤ 7 % Si		160	80	0.150

TEC2-EK-HP612

MMG*	Workpiece material	Strength/hardness [N/mm ²] [HRC]	Cutting speed v _c (m/min)		Feed f _z (mm/z)
			Internal cooling	External cooling	
N N1	N1.1 Aluminium, non-alloy and alloy < 3 % Si		160	80	0.150
	N1.2 Aluminium, alloy ≤ 7 % Si		160	80	0.150

TEC2-DZ-HP612

MMG*	Workpiece material	Strength/hardness [N/mm ²] [HRC]	Cutting speed v _c (m/min)		Feed f _z (mm/z)
			Internal cooling	External cooling	
N N1	N1.1 Aluminium, non-alloy and alloy < 3 % Si		160	80	0.150
	N1.2 Aluminium, alloy ≤ 7 % Si		160	80	0.150

TEC2-04-HP612

MMG*	Workpiece material	Strength/hardness [N/mm ²] [HRC]	Cutting speed v _c (m/min)		Feed f _z (mm/z)
			Internal cooling	External cooling	
N N1	N1.1 Aluminium, non-alloy and alloy < 3 % Si		160	80	0.150
	N1.2 Aluminium, alloy ≤ 7 % Si		160	80	0.150

TEC2-AS-HU615

MMG*	Workpiece material	Strength/hardness [N/mm ²] [HRC]	Cutting speed v _c (m/min)		Feed f _z (mm/z)
			Internal cooling	External cooling	
N N2	N2.1 Copper, unalloyed and low-alloyed	< 300	100	50	0.150
	N2.2 Copper, alloy	> 300	100	50	0.150
	N2.3 Brass, bronze, gunmetal	< 1200	100	50	0.150
S S1 S2	S1.1 Titanium, titanium alloys	< 400	30	15	0.120
	S2.1 Titanium, titanium alloys	< 1200	20	10	0.120
	S2.2 Titanium, titanium alloys	> 1200	20	10	0.100

TEC2-EK-HU615

MMG*	Workpiece material	Strength/hardness [N/mm ²] [HRC]	Cutting speed v _c (m/min)		Feed f _z (mm/z)
			Internal cooling	External cooling	
N N2	N2.1 Copper, unalloyed and low-alloyed	< 300	100	50	0.150
	N2.2 Copper, alloy	> 300	100	50	0.150
	N2.3 Brass, bronze, gunmetal	< 1200	100	50	0.150
S S1 S2	S1.1 Titanium, titanium alloys	< 400	30	15	0.120
	S2.1 Titanium, titanium alloys	< 1200	20	10	0.120
	S2.2 Titanium, titanium alloys	> 1200	20	10	0.100

The specified cutting values are guide values.

The optimum data for the respective machining task should be determined during the test or machining.

Cutting data recommendation for TEC indexable inserts

Feed and cutting speed

TEC2-DZ-HU615

MMG*			Workpiece material	Strength/hardness [N/mm ²] [HRC]	Cutting speed v _c (m/min)		Feed f _z (mm/z)
					Internal cooling	External cooling	
N	N2	N2.1	Copper, unalloyed and low-alloyed	< 300	100	50	0.150
		N2.2	Copper, alloy	> 300	100	50	0.150
		N2.3	Brass, bronze, gunmetal	< 1200	100	50	0.150
S	S1	S1.1	Titanium, titanium alloys	< 400	30	15	0.120
		S2.1	Titanium, titanium alloys	< 1200	20	10	0.120
		S2.2	Titanium, titanium alloys	> 1200	20	10	0.100

TEC2-04-HU615

MMG*			Workpiece material	Strength/hardness [N/mm ²] [HRC]	Cutting speed v _c (m/min)		Feed f _z (mm/z)
					Internal cooling	External cooling	
N	N2	N2.1	Copper, unalloyed and low-alloyed	< 300	100	50	0.150
		N2.2	Copper, alloy	> 300	100	50	0.150
		N2.3	Brass, bronze, gunmetal	< 1200	100	50	0.150
S	S1	S1.1	Titanium, titanium alloys	< 400	30	15	0.120
		S2.1	Titanium, titanium alloys	< 1200	20	10	0.120
		S2.2	Titanium, titanium alloys	> 1200	20	10	0.100

TEC2-DZ-HP016

MMG*			Workpiece material	Strength/hardness [N/mm ²] [HRC]	Cutting speed v _c (m/min)		Feed f _z (mm/z)
					Internal cooling	External cooling	
H	H1	H1.1	Hardened steel / cast steel	45-55	30	15	0.120

TEC2-04-HP016

MMG*			Workpiece material	Strength/hardness [N/mm ²] [HRC]	Cutting speed v _c (m/min)		Feed f _z (mm/z)
					Internal cooling	External cooling	
H	H1	H1.1	Hardened steel / cast steel	45-55	30	15	0.120

* MAPAL machining groups

** If the alloy parts Cr, Mo, Ni, V, W in total > 8% then select the next highest MAPAL machining group.

TEC2-AS-CP122

MMG*		Workpiece material	Strength/hardness [N/mm ²] [HRC]	Cutting speed v _c (m/min)		Feed f _z (mm/z)	
				Internal cooling	External cooling		
P	P1	P1.1	Structural, free-cutting, case hardened and heat-treated steels, non-alloy	< 700	180	90	0.150
		P1.2	Structural, free-cutting, case hardened and heat-treated steels, non-alloy	< 1200	160	80	0.120
	P2	P2.1	Nitrided, case hardened and heat-treated steels, alloy	< 900	160	80	0.150
		P2.2	Nitrided, case hardened and heat-treated steels, alloy	< 1400	140	70	0.120
	P3	P3.1	Tool, bearing, spring and high-speed steels**	< 800	160	80	0.150
		P3.2	Tool, bearing, spring and high-speed steels**	< 1000	160	80	0.150
		P3.3	Tool, bearing, spring and high-speed steels**	< 1500	140	70	0.120
	P5	P5.1	Cast steel		140	70	0.120

TEC2-EK-CP122

MMG*		Workpiece material	Strength/hardness [N/mm ²] [HRC]	Cutting speed v _c (m/min)		Feed f _z (mm/z)	
				Internal cooling	External cooling		
P	P1	P1.1	Structural, free-cutting, case hardened and heat-treated steels, non-alloy	< 700	180	90	0.150
		P1.2	Structural, free-cutting, case hardened and heat-treated steels, non-alloy	< 1200	160	80	0.120
	P2	P2.1	Nitrided, case hardened and heat-treated steels, alloy	< 900	160	80	0.150
		P2.2	Nitrided, case hardened and heat-treated steels, alloy	< 1400	140	70	0.120
	P3	P3.1	Tool, bearing, spring and high-speed steels**	< 800	160	80	0.150
		P3.2	Tool, bearing, spring and high-speed steels**	< 1000	160	80	0.150
		P3.3	Tool, bearing, spring and high-speed steels**	< 1500	140	70	0.120
	P5	P5.1	Cast steel		140	70	0.120

TEC2-DZ-CP122

MMG*		Workpiece material	Strength/hardness [N/mm ²] [HRC]	Cutting speed v _c (m/min)		Feed f _z (mm/z)	
				Internal cooling	External cooling		
P	P1	P1.1	Structural, free-cutting, case hardened and heat-treated steels, non-alloy	< 700	180	90	0.150
		P1.2	Structural, free-cutting, case hardened and heat-treated steels, non-alloy	< 1200	160	80	0.120
	P2	P2.1	Nitrided, case hardened and heat-treated steels, alloy	< 900	160	80	0.150
		P2.2	Nitrided, case hardened and heat-treated steels, alloy	< 1400	140	70	0.120
	P3	P3.1	Tool, bearing, spring and high-speed steels**	< 800	160	80	0.150
		P3.2	Tool, bearing, spring and high-speed steels**	< 1000	160	80	0.150
		P3.3	Tool, bearing, spring and high-speed steels**	< 1500	140	70	0.120
	P5	P5.1	Cast steel		140	70	0.120

The specified cutting values are guide values.

The optimum data for the respective machining task should be determined during the test or machining.

Cutting data recommendation for TEC indexable inserts

Feed and cutting speed

TEC2-04-CP122

MMG*		Workpiece material	Strength/hardness [N/mm ²] [HRC]	Cutting speed v _c (m/min)		Feed f _z (mm/z)	
				Internal cooling	External cooling		
P	P1	P1.1	Structural, free-cutting, case hardened and heat-treated steels, non-alloy	< 700	180	90	0.150
		P1.2	Structural, free-cutting, case hardened and heat-treated steels, non-alloy	< 1200	160	80	0.120
	P2	P2.1	Nitrided, case hardened and heat-treated steels, alloy	< 900	160	80	0.150
		P2.2	Nitrided, case hardened and heat-treated steels, alloy	< 1400	140	70	0.120
	P3	P3.1	Tool, bearing, spring and high-speed steels**	< 800	160	80	0.150
		P3.2	Tool, bearing, spring and high-speed steels**	< 1000	160	80	0.150
		P3.3	Tool, bearing, spring and high-speed steels**	< 1500	140	70	0.120
	P5	P5.1	Cast steel		140	70	0.120

TEC2-AS-PU620

MMG*		Workpiece material	Strength/hardness [N/mm ²] [HRC]	Cutting speed v _c (m/min)		Feed f _z (mm/z)	
				Internal cooling	External cooling		
N	N1	N1.1	Aluminium, non-alloy and alloy < 3 % Si		230	115	0.150
		N1.2	Aluminium, alloy ≤ 7 % Si		230	115	0.150
		N1.3	Aluminium, alloy > 7-12 % Si		230	115	0.150
		N1.4	Aluminium, alloy > 12 % Si		230	115	0.150
	N2	N2.1	Copper, unalloyed and low-alloyed	< 300	180	90	0.150
		N2.2	Copper, alloy	> 300	180	90	0.150
		N2.3	Brass, bronze, gunmetal	< 1200	180	90	0.150

TEC2-EK-PU620

MMG*		Workpiece material	Strength/hardness [N/mm ²] [HRC]	Cutting speed v _c (m/min)		Feed f _z (mm/z)	
				Internal cooling	External cooling		
N	N1	N1.1	Aluminium, non-alloy and alloy < 3 % Si		230	115	0.150
		N1.2	Aluminium, alloy ≤ 7 % Si		230	115	0.150
		N1.3	Aluminium, alloy > 7-12 % Si		230	115	0.150
		N1.4	Aluminium, alloy > 12 % Si		230	115	0.150
	N2	N2.1	Copper, unalloyed and low-alloyed	< 300	180	90	0.150
		N2.2	Copper, alloy	> 300	180	90	0.150
		N2.3	Brass, bronze, gunmetal	< 1200	180	90	0.150

* MAPAL machining groups

** If the alloy parts Cr, Mo, Ni, V, W in total > 8% then select the next highest MAPAL machining group.

TEC2-DZ-PU620

MMG*	Workpiece material	Strength/hardness [N/mm ²] [HRC]	Cutting speed v _c (m/min)		Feed f _z (mm/z)	
			Internal cooling	External cooling		
N	N1	N1.1 Aluminium, non-alloy and alloy < 3 % Si	230	115	0.150	
		N1.2 Aluminium, alloy ≤ 7 % Si	230	115	0.150	
		N1.3 Aluminium, alloy > 7-12 % Si	230	115	0.150	
		N1.4 Aluminium, alloy > 12 % Si	230	115	0.150	
N	N2	N2.1 Copper, unalloyed and low-alloyed	< 300	180	90	0.150
		N2.2 Copper, alloy	> 300	180	90	0.150
		N2.3 Brass, bronze, gunmetal	< 1200	180	90	0.150

TEC2-04-PU620

MMG*	Workpiece material	Strength/hardness [N/mm ²] [HRC]	Cutting speed v _c (m/min)		Feed f _z (mm/z)	
			Internal cooling	External cooling		
N	N1	N1.1 Aluminium, non-alloy and alloy < 3 % Si	230	115	0.150	
		N1.2 Aluminium, alloy ≤ 7 % Si	230	115	0.150	
		N1.3 Aluminium, alloy > 7-12 % Si	230	115	0.150	
		N1.4 Aluminium, alloy > 12 % Si	230	115	0.150	
N	N2	N2.1 Copper, unalloyed and low-alloyed	< 300	180	90	0.150
		N2.2 Copper, alloy	> 300	180	90	0.150
		N2.3 Brass, bronze, gunmetal	< 1200	180	90	0.150

The specified cutting values are guide values.

The optimum data for the respective machining task should be determined during the test or machining.

Cutting data recommendation for TEC indexable inserts

Feed and cutting speed

TEC2-DZ-FU485

MMG*	Workpiece material	Strength/hardness [N/mm ²] [HRC]	Cutting speed v _c (m/min)		Feed f _z (mm/z)
			Internal cooling	External cooling	
K K1 K1.1	Cast iron with lamellar graphite (grey cast iron), GJL	< 300	150	75	0.150

TEC2-04-FU485

MMG*	Workpiece material	Strength/hardness [N/mm ²] [HRC]	Cutting speed v _c (m/min)		Feed f _z (mm/z)
			Internal cooling	External cooling	
K K1 K1.1	Cast iron with lamellar graphite (grey cast iron), GJL	< 300	150	75	0.150

TEC2-DZ-FU801

MMG*		Workpiece material	Strength/hardness [N/mm ²] [HRC]	Cutting speed v _c (m/min)		Feed f _z (mm/z)	
				Internal cooling	External cooling		
H	H1	H1.1	Hardened steel / cast steel	45-55	60	30	0.100
	H1.2	Hardened steel / cast steel	55-64	50	25	0.080	

TEC2-04-FU801

MMG*		Workpiece material	Strength/hardness [N/mm ²] [HRC]	Cutting speed v _c (m/min)		Feed f _z (mm/z)	
				Internal cooling	External cooling		
H	H1	H1.1	Hardened steel / cast steel	45-55	60	30	0.100
		H1.2	Hardened steel / cast steel	55-64	50	25	0.080

The specified cutting values are guide values.

The optimum data for the respective machining task should be determined during the test or machining.



Easy to handle during the external reaming of smaller diameters

MAPAL has developed a new system to make setting external reamers with small diameters as easy as possible. The EasyAdjust system is integrated into a cassette for this purpose. The cassette can be removed to set the insert quickly and easily using a micrometer or measuring plate.

In the EA system, the back taper for the insert is already integrated into the connection for the insert. This feature completely eliminates the need to set the back taper on the minor cutting edge. It is only necessary to set the insert radial distance in relation to the guide pads. Thanks to greater changeover accuracy as well as the fact that the inserts can be set very easily, reliable compliance with the required tolerances for highly accurate fits is significantly easier using the new system, even in the small diameter range.

AT A GLANCE

- New system for easy adjustment during the external reaming of smaller diameters
- Cassette for the EA system integrated into another removable cassette for this purpose
- High changeover accuracy (smaller than 2-3 μm)
- Insert can be adjusted quickly and easily
- Back taper on the insert is integrated into the cassette, which acts as the connection for the insert

ADVANTAGES

- High cost-effectiveness and process reliability
- Reduced setting effort thanks to innovative cassette in cassette
- Easy to handle
- You no longer need to set the back taper on the minor cutting edge
- Reliable compliance with close tolerances



External reamer with EasyAdjust system | System differences

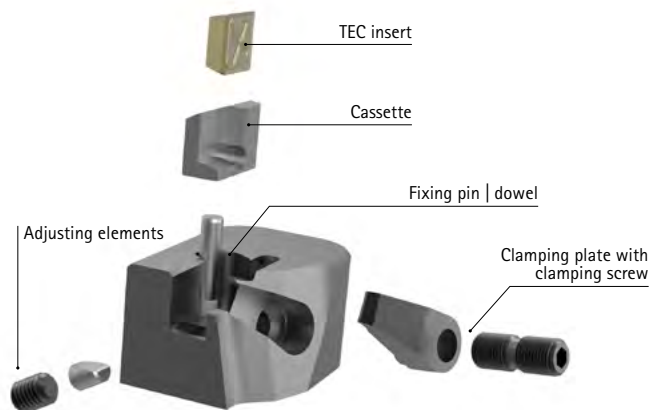

EasyAdjust system with TEC indexable inserts

- Multiple blades (number of cutting edges)
- Easy handling
- TEC2 and TEC3 cutting edge possible

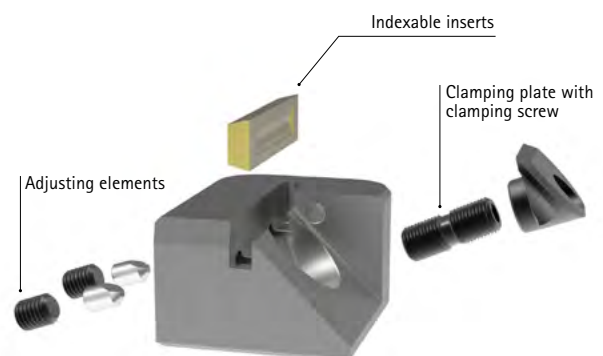

Indexable inserts

- High surface requirements, e.g. $< R_z 6$
- Special contour (indexable inserts)
- Face machining
- Plan section with radius transition

Cutting data recommendation for external machining tools with TEC indexable inserts

Cutting material	Carbide									
MMG*	P			M		K		N		
	1.1 - 1.2	2 - 3 5	4 6	1 - 3	1.1	2 - 3	1.1 - 1.2	2.3	2.1 - 2.2	
Cutting material type	HP115	HP425	HP016	HP016	HC418	HP426	HP612	HU615		

Chip form geometry.	Size	Lead	Specification	Order no.								
neutral	2	AS	WP-TEC2-ASE02LOA-...									
		EK **	WP-TEC2-EKE02LOA-...									
		DZ	WP-TEC2-DZE02LOA-...					31306931				
		R0,4 **	WP-TEC2-04E02LOA-...					31306932				

positive	2	AS	WP-TEC2-ASF01L1G-...	31306933	30889440	31079651	31079651				31140267	
		EK **	WP-TEC2-EKF01L1G-...	30653470	30829191	30971023	30971023				30630537	
		DZ	WP-TEC2-DZF01L1G-...	31306937	31306938	31306940	31306940		31306941		31181002	
		R0,4 **	WP-TEC2-04F01L1J-...	31306945	31306947	31306949	31306949		31306950		31306951	

highly positive	2	AS	WP-TEC2-ASF01L1N-...							31306973		31306974
		EK **	WP-TEC2-EKF01L1N-...							31306977		31306978
		DZ	WP-TEC2-DZF01L1N-...							31306979		31306980
		R0,4 **	WP-TEC2-04F01L1U-...							31306981		31306982

** Note: Only use EK and R0.4 leads for blind bores machining and component-related face machining.



Carbide		
S		H
1 - 2		1.1
HU615		HP016

Cermet	
P	
1 - 3 5	
CP122	

PCD	
N	
1 - 2	
PU620	

PcBN		
K		H
1.1		1.1 - 1.2
FU485		FU801

Order no.		

Order no.	

Order no.	

Order no.		

31301539	
30627301	
31306942	
31307406	

31306934**	
30630446**	
31306943**	
31306953**	

31306974		
31306978		
31306980		
31306982		

For cutting data recommendations, see end of chapter.
Cutting edges with special lead available on request.

Cutting data recommendation for external machining tools with indexable inserts

Cutting material	Carbide									
MMG*	P			M		K		N		
	1.1 - 1.2	2 - 3 5	4 6	1 - 3	1.1	2 - 3	1.1 - 1.2	2.3	2.1 - 2.2	
Cutting material type	HP115	HP425	HP016	HP016	HC418	HP426	HP612	HU615		

Chip form geometry.	Size	Lead	Specification	Order no.							
neutral	92	AS	WP-AS92L0-...								
		EK	WP-EK152L0-...								
		DZ	WP-DZ92L0-...					31301508			

positive	92	AS	WP-AS92L6-...	30914125	30914127	31056555	31056555				30914124
		EK	WP-EK152L6-...	30914554	31302302	31247603	31247603				30914553
		DZ	WP-DZ92L6-...	31306923	31306925	31306926	31306926		31306927		30914421

highly positive	92	AS	WP-AS92L2-...							31175426		30914120
		EK	WP-EK152L2-...							31301535		30914549
		DZ	WP-DZ92L2-...									

* MAPAL machining groups.

Cutting edge with AS lead



Cutting edge with EK lead

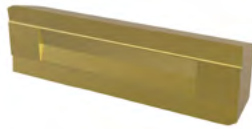

Cutting edge with DZ lead



Carbide		
S		H
1 - 2		1.1
HU615		HP016

Cermet	
P	
1 - 3 5	
CP122	

PCD	
N	
1 - 2	
PU620	

PcBN		
K		H
1.1		1.1 - 1.2
FU485		FU801

Order no.		

Order no.	

Order no.	

Order no.		

30309015	
31301541	
31306928	

30914763**	
30914788**	

30914120		
30914549		

For cutting data recommendations, see end of chapter.
Cutting edges with special lead available on request.

Accessories for external machining tool



TEC cutting edge size	Blade cassettes for external machining tool		Clamping plates for external machining tool	
	Specification	Order no.	Specification	Order no.
2	BC-EAS-L-42-B	30562954	CP-EAS-L-N2-B	30565468
2	BC-EAS-L-42-D	30558608	CP-EAS-L-N2-D	30560195
2	BC-EAS-L-42-F	30562956	CP-EAS-L-N2-F	30565469
2	BC-EAS-L-42-H	30562958	CP-EAS-L-N2-H	30565470
2	BC-EAS-L-42-K	30562959	CP-EAS-L-N2-K	30565472
2	BC-EAS-L-42-M	30562960	CP-EAS-L-N2-M	30565474
2	BC-EAS-L-42-P	30562963	CP-EAS-L-N2-P	30565475
2	BC-EAS-L-42-R	30562964	CP-EAS-L-N2-R	30565478
3	BC-EAS-L-43-B	30562965	CP-EAS-L-N3-B	30565479
3	BC-EAS-L-43-D	30562967	CP-EAS-L-N3-D	30565481
3	BC-EAS-L-43-F	30562968	CP-EAS-L-N3-F	30565483
3	BC-EAS-L-43-H	30562969	CP-EAS-L-N3-H	30565490
3	BC-EAS-L-43-K	30562970	CP-EAS-L-N3-K	30565491
3	BC-EAS-L-43-M	30562971	CP-EAS-L-N3-M	30565492
3	BC-EAS-L-43-P	30562972	CP-EAS-L-N3-P	30565494
3	BC-EAS-L-43-R	30562974	CP-EAS-L-N3-R	30565495

Note:

When changing the system, it is essential to note that the cassette and clamping plate must be adapted accordingly.



Cutting data recommendation for external machining tools with TEC indexable inserts

Feed and cutting speed

TEC2-AS-L-HP115

MMG*		Workpiece material	Strength/hardness [N/mm ²] [HRC]	Cutting speed v_c (m/min)	Feed f_z (mm/z)	
				Internal cooling		
P	P1	P1.1	Structural, free-cutting, case hardened and heat-treated steels, non-alloy	< 700	80	0.150
		P1.2	Structural, free-cutting, case hardened and heat-treated steels, non-alloy	< 1200	70	0.150

TEC2-EK-L-HP115

MMG*		Workpiece material	Strength/hardness [N/mm ²] [HRC]	Cutting speed v_c (m/min)	Feed f_z (mm/z)	
				Internal cooling		
P	P1	P1.1	Structural, free-cutting, case hardened and heat-treated steels, non-alloy	< 700	80	0.150
		P1.2	Structural, free-cutting, case hardened and heat-treated steels, non-alloy	< 1200	70	0.150

TEC2-DZ-L-HP115

MMG*		Workpiece material	Strength/hardness [N/mm ²] [HRC]	Cutting speed v_c (m/min)	Feed f_z (mm/z)	
				Internal cooling		
P	P1	P1.1	Structural, free-cutting, case hardened and heat-treated steels, non-alloy	< 700	80	0.150
		P1.2	Structural, free-cutting, case hardened and heat-treated steels, non-alloy	< 1200	70	0.150

TEC2-04-L-HP115

MMG*		Workpiece material	Strength/hardness [N/mm ²] [HRC]	Cutting speed v_c (m/min)	Feed f_z (mm/z)	
				Internal cooling		
P	P1	P1.1	Structural, free-cutting, case hardened and heat-treated steels, non-alloy	< 700	80	0.150
		P1.2	Structural, free-cutting, case hardened and heat-treated steels, non-alloy	< 1200	70	0.150

TEC2-AS-L-HP425

MMG*		Workpiece material	Strength/hardness [N/mm ²] [HRC]	Cutting speed v_c (m/min)	Feed f_z (mm/z)	
				Internal cooling		
P	P2	P2.1	Nitrided, case hardened and heat-treated steels, alloy	< 900	100	0.150
		P2.2	Nitrided, case hardened and heat-treated steels, alloy	< 1400	80	0.150
	P3	P3.1	Tool, bearing, spring and high-speed steels**	< 900	100	0.150
		P3.2	Tool, bearing, spring and high-speed steels**	< 1500	80	0.150
	P5	P5.1	Cast steel		80	0.150

* MAPAL machining groups

** If the alloy parts Cr, Mo, Ni, V, W in total > 8% then select the next highest MAPAL machining group.

TEC2-EK-L-HP425

MMG*		Workpiece material	Strength/hardness [N/mm ²] [HRC]	Cutting speed v _c (m/min)	Feed f _z (mm/z)	
				Internal cooling		
P	P2	P2.1	Nitrided, case hardened and heat-treated steels, alloy	< 900	100	0.150
		P2.2	Nitrided, case hardened and heat-treated steels, alloy	< 1400	80	0.150
	P3	P3.1	Tool, bearing, spring and high-speed steels**	< 900	100	0.150
		P3.2	Tool, bearing, spring and high-speed steels**	< 1500	80	0.150
	P5	P5.1	Cast steel		80	0.150

TEC2-DZ-L-HP425

MMG*		Workpiece material	Strength/hardness [N/mm ²] [HRC]	Cutting speed v _c (m/min)	Feed f _z (mm/z)	
				Internal cooling		
P	P2	P2.1	Nitrided, case hardened and heat-treated steels, alloy	< 900	100	0.150
		P2.2	Nitrided, case hardened and heat-treated steels, alloy	< 1400	80	0.150
	P3	P3.1	Tool, bearing, spring and high-speed steels**	< 900	100	0.150
		P3.2	Tool, bearing, spring and high-speed steels**	< 1500	80	0.150
	P5	P5.1	Cast steel		80	0.150

TEC2-04-L-HP425

MMG*		Workpiece material	Strength/hardness [N/mm ²] [HRC]	Cutting speed v _c (m/min)	Feed f _z (mm/z)	
				Internal cooling		
P	P2	P2.1	Nitrided, case hardened and heat-treated steels, alloy	< 900	100	0.150
		P2.2	Nitrided, case hardened and heat-treated steels, alloy	< 1400	80	0.150
	P3	P3.1	Tool, bearing, spring and high-speed steels**	< 900	100	0.150
		P3.2	Tool, bearing, spring and high-speed steels**	< 1500	80	0.150
	P5	P5.1	Cast steel		80	0.150

TEC2-AS-L-HP016

MMG*		Workpiece material	Strength/hardness [N/mm ²] [HRC]	Cutting speed v _c (m/min)	Feed f _z (mm/z)
				Internal cooling	
P	P4	P4.1	Stainless steels, ferritic and martensitic	50	0.120
	P6	P6.1	Stainless cast steel, ferritic and martensitic	40	0.120
M	M1	M1.1	Stainless steels, austenitic	50	0.120
		M1.2	Stainless steels, ferritic/austenitic (duplex)	30	0.120
	M2	M2.1	Stainless/heat-resistant cast steel, austenitic	50	0.120
M3	M3.1	Stainless cast steel, ferritic/austenitic (duplex)	< 1000	30	0.120

The specified cutting values are guide values.

The optimum data for the respective machining task should be determined during the test or machining.

Cutting data recommendation for external machining tools with TEC indexable inserts

Feed and cutting speed

TEC2-EK-L-HP016

MMG*	Workpiece material	Strength/hardness [N/mm ²] [HRC]	Cutting speed v _c (m/min)	Feed f _z (mm/z)		
			Internal cooling			
P4	P4.1	Stainless steels, ferritic and martensitic	50	0.120		
	P6.1	Stainless cast steel, ferritic and martensitic	40	0.120		
M	M1	M1.1	Stainless steels, austenitic	< 700	50	0.120
		M1.2	Stainless steels, ferritic/austenitic (duplex)	< 1000	30	0.120
	M2	M2.1	Stainless/heat-resistant cast steel, austenitic	< 700	50	0.120
	M3	M3.1	Stainless cast steel, ferritic/austenitic (duplex)	< 1000	30	0.120

TEC2-DZ-L-HP016

MMG*	Workpiece material	Strength/hardness [N/mm ²] [HRC]	Cutting speed v _c (m/min)	Feed f _z (mm/z)		
			Internal cooling			
P4	P4.1	Stainless steels, ferritic and martensitic	50	0.120		
	P6.1	Stainless cast steel, ferritic and martensitic	40	0.120		
M	M1	M1.1	Stainless steels, austenitic	< 700	50	0.120
		M1.2	Stainless steels, ferritic/austenitic (duplex)	< 1000	30	0.120
	M2	M2.1	Stainless/heat-resistant cast steel, austenitic	< 700	50	0.120
	M3	M3.1	Stainless cast steel, ferritic/austenitic (duplex)	< 1000	30	0.120

TEC2-04-L-HP016

MMG*	Workpiece material	Strength/hardness [N/mm ²] [HRC]	Cutting speed v _c (m/min)	Feed f _z (mm/z)		
			Internal cooling			
P4	P4.1	Stainless steels, ferritic and martensitic	50	0.120		
	P6.1	Stainless cast steel, ferritic and martensitic	40	0.120		
M	M1	M1.1	Stainless steels, austenitic	< 700	50	0.120
		M1.2	Stainless steels, ferritic/austenitic (duplex)	< 1000	30	0.120
	M2	M2.1	Stainless/heat-resistant cast steel, austenitic	< 700	50	0.120
	M3	M3.1	Stainless cast steel, ferritic/austenitic (duplex)	< 1000	30	0.120

TEC2-DZ-L-HC418

MMG*	Workpiece material	Strength/hardness [N/mm ²] [HRC]	Cutting speed v _c (m/min)	Feed f _z (mm/z)		
			Internal cooling			
K	K1	K1.1	Cast iron with lamellar graphite (grey cast iron), GJL	< 300	100	0.150

TEC2-04-L-HC418

MMG*	Workpiece material	Strength/hardness [N/mm ²] [HRC]	Cutting speed v _c (m/min)	Feed f _z (mm/z)
			Internal cooling	
K K1	K1.1 Cast iron with lamellar graphite (grey cast iron), GJL	< 300	100	0.150

TEC2-DZ-L-HP426

MMG*	Workpiece material	Strength/hardness [N/mm ²] [HRC]	Cutting speed v _c (m/min)	Feed f _z (mm/z)
			Internal cooling	
K2	K2.1 Cast iron with spheroidal graphite, GJS	< 500	100	0.150
	K2.2 Cast iron with spheroidal graphite, GJS	≤ 800	90	0.150
	K2.3 Cast iron with spheroidal graphite, GJS	> 800	80	0.150
K3	K3.1 Cast iron with spheroidal graphite, GJV; malleable cast iron, GJM	< 500	70	0.150
	K3.2 Cast iron with spheroidal graphite, GJV; malleable cast iron, GJM	> 500	70	0.150

TEC2-04-L-HP426

MMG*	Workpiece material	Strength/hardness [N/mm ²] [HRC]	Cutting speed v _c (m/min)	Feed f _z (mm/z)
			Internal cooling	
K2	K2.1 Cast iron with spheroidal graphite, GJS	< 500	100	0.150
	K2.2 Cast iron with spheroidal graphite, GJS	≤ 800	90	0.150
	K2.3 Cast iron with spheroidal graphite, GJS	> 800	80	0.150
K3	K3.1 Cast iron with spheroidal graphite, GJV; malleable cast iron, GJM	< 500	70	0.150
	K3.2 Cast iron with spheroidal graphite, GJV; malleable cast iron, GJM	> 500	70	0.150

TEC2-AS-L-HP612

MMG*	Workpiece material	Strength/hardness [N/mm ²] [HRC]	Cutting speed v _c (m/min)	Feed f _z (mm/z)
			Internal cooling	
N N1	N1.1 Aluminium, non-alloy and alloy < 3 % Si		160	0.150
	N1.2 Aluminium, alloy ≤ 7 % Si		160	0.150

TEC2-EK-L-HP612

MMG*	Workpiece material	Strength/hardness [N/mm ²] [HRC]	Cutting speed v _c (m/min)	Feed f _z (mm/z)
			Internal cooling	
N N1	N1.1 Aluminium, non-alloy and alloy < 3 % Si		160	0.150
	N1.2 Aluminium, alloy ≤ 7 % Si		160	0.150

The specified cutting values are guide values.

The optimum data for the respective machining task should be determined during the test or machining.

Cutting data recommendation for external machining tools with TEC indexable inserts

Feed and cutting speed

TEC2-DZ-L-HP612

MMG*		Workpiece material	Strength/hardness [N/mm ²] [HRC]	Cutting speed v_c (m/min)	Feed f_z (mm/z)
				Internal cooling	
N	N1	N1.1	Aluminium, non-alloy and alloy < 3 % Si	160	0.150
		N1.2	Aluminium, alloy ≤ 7 % Si	160	0.150

TEC2-04-L-HP612

MMG*		Workpiece material	Strength/hardness [N/mm ²] [HRC]	Cutting speed v_c (m/min)	Feed f_z (mm/z)
				Internal cooling	
N	N1	N1.1	Aluminium, non-alloy and alloy < 3 % Si	160	0.150
		N1.2	Aluminium, alloy ≤ 7 % Si	160	0.150

TEC2-AS-L-HU615

MMG*		Workpiece material	Strength/hardness [N/mm ²] [HRC]	Cutting speed v_c (m/min)	Feed f_z (mm/z)
				Internal cooling	
N	N2	N2.1	Copper, unalloyed and low-alloyed	100	0.150
		N2.2	Copper, alloy	100	0.150
		N2.3	Brass, bronze, gunmetal	100	0.150
S	S1	S1.1	Titanium, titanium alloys	30	0.120
		S2.1	Titanium, titanium alloys	20	0.120
		S2.2	Titanium, titanium alloys	20	0.100

TEC2-EK-L-HU615

MMG*		Workpiece material	Strength/hardness [N/mm ²] [HRC]	Cutting speed v_c (m/min)	Feed f_z (mm/z)
				Internal cooling	
N	N2	N2.1	Copper, unalloyed and low-alloyed	100	0.150
		N2.2	Copper, alloy	100	0.150
		N2.3	Brass, bronze, gunmetal	100	0.150
S	S1	S1.1	Titanium, titanium alloys	30	0.120
		S2.1	Titanium, titanium alloys	20	0.120
		S2.2	Titanium, titanium alloys	20	0.100

* MAPAL machining groups

** If the alloy parts Cr, Mo, Ni, V, W in total > 8% then select the next highest MAPAL machining group.

TEC2-DZ-L-HU615

MMG*		Workpiece material	Strength/hardness [N/mm ²] [HRC]	Cutting speed v _c (m/min)	Feed f _z (mm/z)	
				Internal cooling		
N	N2	N2.1	Copper, unalloyed and low-alloyed	< 300	100	0.150
		N2.2	Copper, alloy	> 300	100	0.150
		N2.3	Brass, bronze, gunmetal	< 1200	100	0.150
S	S1	S1.1	Titanium, titanium alloys	< 400	30	0.120
		S2.1	Titanium, titanium alloys	< 1200	20	0.120
		S2.2	Titanium, titanium alloys	> 1200	20	0.100

TEC2-04-L-HU615

MMG*		Workpiece material	Strength/hardness [N/mm ²] [HRC]	Cutting speed v _c (m/min)	Feed f _z (mm/z)	
				Internal cooling		
N	N2	N2.1	Copper, unalloyed and low-alloyed	< 300	100	0.150
		N2.2	Copper, alloy	> 300	100	0.150
		N2.3	Brass, bronze, gunmetal	< 1200	100	0.150
S	S1	S1.1	Titanium, titanium alloys	< 400	30	0.120
		S2.1	Titanium, titanium alloys	< 1200	20	0.120
		S2.2	Titanium, titanium alloys	> 1200	20	0.100

TEC2-AS-L-CP122

MMG*		Workpiece material	Strength/hardness [N/mm ²] [HRC]	Cutting speed v _c (m/min)	Feed f _z (mm/z)	
				Internal cooling		
P1	P1	P1.1	Structural, free-cutting, case hardened and heat-treated steels, non-alloy	< 700	180	0.150
		P1.2	Structural, free-cutting, case hardened and heat-treated steels, non-alloy	< 1200	160	0.120
P2	P2	P2.1	Nitrided, case hardened and heat-treated steels, alloy	< 900	160	0.150
		P2.2	Nitrided, case hardened and heat-treated steels, alloy	< 1400	140	0.120
P3	P3	P3.1	Tool, bearing, spring and high-speed steels**	< 800	160	0.150
		P3.2	Tool, bearing, spring and high-speed steels**	< 1000	160	0.150
		P3.3	Tool, bearing, spring and high-speed steels**	< 1500	140	0.120
P5	P5.1	Cast steel		140	0.120	

The specified cutting values are guide values.

The optimum data for the respective machining task should be determined during the test or machining.

Cutting data recommendation for external machining tools with TEC indexable inserts

Feed and cutting speed

TEC2-EK-L-CP122

MMG*		Workpiece material	Strength/hardness [N/mm ²] [HRC]	Cutting speed v _c (m/min)	Feed f _z (mm/z)	
				Internal cooling		
P	P1	P1.1	Structural, free-cutting, case hardened and heat-treated steels, non-alloy	< 700	180	0.150
		P1.2	Structural, free-cutting, case hardened and heat-treated steels, non-alloy	< 1200	160	0.120
	P2	P2.1	Nitrided, case hardened and heat-treated steels, alloy	< 900	160	0.150
		P2.2	Nitrided, case hardened and heat-treated steels, alloy	< 1400	140	0.120
	P3	P3.1	Tool, bearing, spring and high-speed steels**	< 800	160	0.150
		P3.2	Tool, bearing, spring and high-speed steels**	< 1000	160	0.150
		P3.3	Tool, bearing, spring and high-speed steels**	< 1500	140	0.120
	P5	P5.1	Cast steel		140	0.120

TEC2-DZ-L-CP122

MMG*		Workpiece material	Strength/hardness [N/mm ²] [HRC]	Cutting speed v _c (m/min)	Feed f _z (mm/z)	
				Internal cooling		
P	P1	P1.1	Structural, free-cutting, case hardened and heat-treated steels, non-alloy	< 700	180	0.150
		P1.2	Structural, free-cutting, case hardened and heat-treated steels, non-alloy	< 1200	160	0.120
	P2	P2.1	Nitrided, case hardened and heat-treated steels, alloy	< 900	160	0.150
		P2.2	Nitrided, case hardened and heat-treated steels, alloy	< 1400	140	0.120
	P3	P3.1	Tool, bearing, spring and high-speed steels**	< 800	160	0.150
		P3.2	Tool, bearing, spring and high-speed steels**	< 1000	160	0.150
		P3.3	Tool, bearing, spring and high-speed steels**	< 1500	140	0.120
	P5	P5.1	Cast steel		140	0.120

TEC2-04-L-CP122

MMG*		Workpiece material	Strength/hardness [N/mm ²] [HRC]	Cutting speed v _c (m/min)	Feed f _z (mm/z)	
				Internal cooling		
P	P1	P1.1	Structural, free-cutting, case hardened and heat-treated steels, non-alloy	< 700	180	0.150
		P1.2	Structural, free-cutting, case hardened and heat-treated steels, non-alloy	< 1200	160	0.120
	P2	P2.1	Nitrided, case hardened and heat-treated steels, alloy	< 900	160	0.150
		P2.2	Nitrided, case hardened and heat-treated steels, alloy	< 1400	140	0.120
	P3	P3.1	Tool, bearing, spring and high-speed steels**	< 800	160	0.150
		P3.2	Tool, bearing, spring and high-speed steels**	< 1000	160	0.150
		P3.3	Tool, bearing, spring and high-speed steels**	< 1500	140	0.120
	P5	P5.1	Cast steel		140	0.120

* MAPAL machining groups

** If the alloy parts Cr, Mo, Ni, V, W in total > 8% then select the next highest MAPAL machining group.

TEC2-AS-L-PU620

MMG*	Workpiece material	Strength/hardness [N/mm ²] [HRC]	Cutting speed v _c (m/min)	Feed f _z (mm/z)
			Internal cooling	
N	N1	N1.1 Aluminium, non-alloy and alloy < 3 % Si	230	0.150
		N1.2 Aluminium, alloy ≤ 7 % Si	230	0.150
		N1.3 Aluminium, alloy > 7-12 % Si	230	0.150
		N1.4 Aluminium, alloy > 12 % Si	230	0.150
N	N2	N2.1 Copper, unalloyed and low-alloyed	< 300	180
		N2.2 Copper, alloy	> 300	180
		N2.3 Brass, bronze, gunmetal	< 1200	180

TEC2-EK-L-PU620

MMG*	Workpiece material	Strength/hardness [N/mm ²] [HRC]	Cutting speed v _c (m/min)	Feed f _z (mm/z)
			Internal cooling	
N	N1	N1.1 Aluminium, non-alloy and alloy < 3 % Si	230	0.150
		N1.2 Aluminium, alloy ≤ 7 % Si	230	0.150
		N1.3 Aluminium, alloy > 7-12 % Si	230	0.150
		N1.4 Aluminium, alloy > 12 % Si	230	0.150
N	N2	N2.1 Copper, unalloyed and low-alloyed	< 300	180
		N2.2 Copper, alloy	> 300	180
		N2.3 Brass, bronze, gunmetal	< 1200	180

TEC2-DZ-L-PU620

MMG*	Workpiece material	Strength/hardness [N/mm ²] [HRC]	Cutting speed v _c (m/min)	Feed f _z (mm/z)
			Internal cooling	
N	N1	N1.1 Aluminium, non-alloy and alloy < 3 % Si	230	0.150
		N1.2 Aluminium, alloy ≤ 7 % Si	230	0.150
		N1.3 Aluminium, alloy > 7-12 % Si	230	0.150
		N1.4 Aluminium, alloy > 12 % Si	230	0.150
N	N2	N2.1 Copper, unalloyed and low-alloyed	< 300	180
		N2.2 Copper, alloy	> 300	180
		N2.3 Brass, bronze, gunmetal	< 1200	180

TEC2-04-L-PU620

MMG*	Workpiece material	Strength/hardness [N/mm ²] [HRC]	Cutting speed v _c (m/min)	Feed f _z (mm/z)
			Internal cooling	
N	N1	N1.1 Aluminium, non-alloy and alloy < 3 % Si	230	0.150
		N1.2 Aluminium, alloy ≤ 7 % Si	230	0.150
		N1.3 Aluminium, alloy > 7-12 % Si	230	0.150
		N1.4 Aluminium, alloy > 12 % Si	230	0.150
N	N2	N2.1 Copper, unalloyed and low-alloyed	< 300	180
		N2.2 Copper, alloy	> 300	180
		N2.3 Brass, bronze, gunmetal	< 1200	180

The specified cutting values are guide values.

The optimum data for the respective machining task should be determined during the test or machining.

Cutting data recommendation for external machining tools with indexable inserts

Feed and cutting speed

AS-L-HP115

MMG*	Workpiece material	Strength/hardness [N/mm ²] [HRC]	Cutting speed v_c (m/min)	Feed f_z (mm/z)	
			Internal cooling		
P P1	P1.1	Structural, free-cutting, case hardened and heat-treated steels, non-alloy	< 700	80	0.150
	P1.2	Structural, free-cutting, case hardened and heat-treated steels, non-alloy	< 1200	70	0.150

EK-L-HP115

MMG*	Workpiece material	Strength/hardness [N/mm ²] [HRC]	Cutting speed v_c (m/min)	Feed f_z (mm/z)	
			Internal cooling		
P P1	P1.1	Structural, free-cutting, case hardened and heat-treated steels, non-alloy	< 700	80	0.150
	P1.2	Structural, free-cutting, case hardened and heat-treated steels, non-alloy	< 1200	70	0.150

DZ-L-HP115

MMG*	Workpiece material	Strength/hardness [N/mm ²] [HRC]	Cutting speed v_c (m/min)	Feed f_z (mm/z)	
			Internal cooling		
P P1	P1.1	Structural, free-cutting, case hardened and heat-treated steels, non-alloy	< 700	80	0.150
	P1.2	Structural, free-cutting, case hardened and heat-treated steels, non-alloy	< 1200	70	0.150

AS-L-HP425

MMG*	Workpiece material	Strength/hardness [N/mm ²] [HRC]	Cutting speed v_c (m/min)	Feed f_z (mm/z)		
			Internal cooling			
P	P2	P2.1	Nitrided, case hardened and heat-treated steels, alloy	< 900	100	0.150
		P2.2	Nitrided, case hardened and heat-treated steels, alloy	< 1400	80	0.150
	P3	P3.1	Tool, bearing, spring and high-speed steels**	< 900	100	0.150
		P3.2	Tool, bearing, spring and high-speed steels**	< 1500	80	0.150
	P5	P5.1	Cast steel		80	0.150

* MAPAL machining groups

** If the alloy parts Cr, Mo, Ni, V, W in total > 8% then select the next highest MAPAL machining group.

EK-L-HP425

MMG*		Workpiece material	Strength/hardness [N/mm ²] [HRC]	Cutting speed v _c (m/min)	Feed f _z (mm/z)	
				Internal cooling		
P	P2	P2.1	Nitrided, case hardened and heat-treated steels, alloy	< 900	100	0.150
		P2.2	Nitrided, case hardened and heat-treated steels, alloy	< 1400	80	0.150
	P3	P3.1	Tool, bearing, spring and high-speed steels**	< 900	100	0.150
		P3.2	Tool, bearing, spring and high-speed steels**	< 1500	80	0.150
	P5	P5.1	Cast steel		80	0.150

DZ-L-HP425

MMG*		Workpiece material	Strength/hardness [N/mm ²] [HRC]	Cutting speed v _c (m/min)	Feed f _z (mm/z)	
				Internal cooling		
P	P2	P2.1	Nitrided, case hardened and heat-treated steels, alloy	< 900	100	0.150
		P2.2	Nitrided, case hardened and heat-treated steels, alloy	< 1400	80	0.150
	P3	P3.1	Tool, bearing, spring and high-speed steels**	< 900	100	0.150
		P3.2	Tool, bearing, spring and high-speed steels**	< 1500	80	0.150
	P5	P5.1	Cast steel		80	0.150

AS-L-HP016

MMG*		Workpiece material	Strength/hardness [N/mm ²] [HRC]	Cutting speed v _c (m/min)	Feed f _z (mm/z)	
				Internal cooling		
P	P4	P4.1	Stainless steels, ferritic and martensitic		50	0.120
	P6	P6.1	Stainless cast steel, ferritic and martensitic		40	0.120
M	M1	M1.1	Stainless steels, austenitic	< 700	50	0.120
		M1.2	Stainless steels, ferritic/austenitic (duplex)	< 1000	30	0.120
	M2	M2.1	Stainless/heat-resistant cast steel, austenitic	< 700	50	0.120
	M3	M3.1	Stainless cast steel, ferritic/austenitic (duplex)	< 1000	30	0.120

EK-L-HP016

MMG*		Workpiece material	Strength/hardness [N/mm ²] [HRC]	Cutting speed v _c (m/min)	Feed f _z (mm/z)	
				Internal cooling		
P	P4	P4.1	Stainless steels, ferritic and martensitic		50	0.120
	P6	P6.1	Stainless cast steel, ferritic and martensitic		40	0.120
M	M1	M1.1	Stainless steels, austenitic	< 700	50	0.120
		M1.2	Stainless steels, ferritic/austenitic (duplex)	< 1000	30	0.120
	M2	M2.1	Stainless/heat-resistant cast steel, austenitic	< 700	50	0.120
	M3	M3.1	Stainless cast steel, ferritic/austenitic (duplex)	< 1000	30	0.120

The specified cutting values are guide values.

The optimum data for the respective machining task should be determined during the test or machining.

Cutting data recommendation for external machining tools with indexable inserts

Feed and cutting speed

DZ-L-HP016

MMG*		Workpiece material	Strength/hardness [N/mm ²] [HRC]	Cutting speed v _c (m/min)	Feed f _z (mm/z)	
				Internal cooling		
P4	P4.1	Stainless steels, ferritic and martensitic		50	0.120	
	P6.1	Stainless cast steel, ferritic and martensitic		40	0.120	
M	M1	M1.1	Stainless steels, austenitic	< 700	50	0.120
		M1.2	Stainless steels, ferritic/austenitic (duplex)	< 1000	30	0.120
	M2	M2.1	Stainless/heat-resistant cast steel, austenitic	< 700	50	0.120
	M3	M3.1	Stainless cast steel, ferritic/austenitic (duplex)	< 1000	30	0.120

DZ-L-HC418

MMG*		Workpiece material	Strength/hardness [N/mm ²] [HRC]	Cutting speed v _c (m/min)	Feed f _z (mm/z)	
				Internal cooling		
K	K1	K1.1	Cast iron with lamellar graphite (grey cast iron), GJL	< 300	100	0.150

DZ-L-HP426

MMG*		Workpiece material	Strength/hardness [N/mm ²] [HRC]	Cutting speed v _c (m/min)	Feed f _z (mm/z)	
				Internal cooling		
K2	K2	K2.1	Cast iron with spheroidal graphite, GJS	< 500	100	0.150
		K2.2	Cast iron with spheroidal graphite, GJS	≤ 800	90	0.150
		K2.3	Cast iron with spheroidal graphite, GJS	> 800	80	0.150
K3	K3	K3.1	Cast iron with spheroidal graphite, GJV; malleable cast iron, GJM	< 500	70	0.150
		K3.2	Cast iron with spheroidal graphite, GJV; malleable cast iron, GJM	> 500	70	0.150

AS-L-HP612

MMG*		Workpiece material	Strength/hardness [N/mm ²] [HRC]	Cutting speed v _c (m/min)	Feed f _z (mm/z)
				Internal cooling	
N	N1	N1.1	Aluminium, non-alloy and alloy < 3 % Si	160	0.150
		N1.2	Aluminium, alloy ≤ 7 % Si	160	0.150

EK-L-HP612

MMG*		Workpiece material	Strength/hardness [N/mm ²] [HRC]	Cutting speed v _c (m/min)	Feed f _z (mm/z)
				Internal cooling	
N	N1	N1.1	Aluminium, non-alloy and alloy < 3 % Si	160	0.150
		N1.2	Aluminium, alloy ≤ 7 % Si	160	0.150

* MAPAL machining groups

AS-L-HU615

MMG*		Workpiece material	Strength/hardness [N/mm ²] [HRC]	Cutting speed v _c (m/min)	Feed f _z (mm/z)	
				Internal cooling		
N	N2	N2.1	Copper, unalloyed and low-alloyed	< 300	100	0.150
		N2.2	Copper, alloy	> 300	100	0.150
		N2.3	Brass, bronze, gunmetal	< 1200	100	0.150
S	S1	S1.1	Titanium, titanium alloys	< 400	30	0.120
		S2.1	Titanium, titanium alloys	< 1200	20	0.120
		S2.2	Titanium, titanium alloys	> 1200	20	0.100

EK-L-HU615

MMG*		Workpiece material	Strength/hardness [N/mm ²] [HRC]	Cutting speed v _c (m/min)	Feed f _z (mm/z)	
				Internal cooling		
N	N2	N2.1	Copper, unalloyed and low-alloyed	< 300	100	0.150
		N2.2	Copper, alloy	> 300	100	0.150
		N2.3	Brass, bronze, gunmetal	< 1200	100	0.150
S	S1	S1.1	Titanium, titanium alloys	< 400	30	0.120
		S2.1	Titanium, titanium alloys	< 1200	20	0.120
		S2.2	Titanium, titanium alloys	> 1200	20	0.100

DZ-L-HU615

MMG*		Workpiece material	Strength/hardness [N/mm ²] [HRC]	Cutting speed v _c (m/min)	Feed f _z (mm/z)	
				Internal cooling		
N	N2	N2.1	Copper, unalloyed and low-alloyed	< 300	100	0.150
		N2.2	Copper, alloy	> 300	100	0.150
		N2.3	Brass, bronze, gunmetal	< 1200	100	0.150

The specified cutting values are guide values.

The optimum data for the respective machining task should be determined during the test or machining.

Cutting data recommendation for external machining tools with indexable inserts

Feed and cutting speed

AS-L-CP122

MMG*		Workpiece material	Strength/hardness [N/mm ²] [HRC]	Cutting speed v_c (m/min)	Feed f_z (mm/z)	
				Internal cooling		
P	P1	P1.1	Structural, free-cutting, case hardened and heat-treated steels, non-alloy	< 700	180	0.150
		P1.2	Structural, free-cutting, case hardened and heat-treated steels, non-alloy	< 1200	160	0.120
	P2	P2.1	Nitrided, case hardened and heat-treated steels, alloy	< 900	160	0.150
		P2.2	Nitrided, case hardened and heat-treated steels, alloy	< 1400	140	0.120
	P3	P3.1	Tool, bearing, spring and high-speed steels**	< 800	160	0.150
		P3.2	Tool, bearing, spring and high-speed steels**	< 1000	160	0.150
		P3.3	Tool, bearing, spring and high-speed steels**	< 1500	140	0.120
	P5	P5.1	Cast steel		140	0.120

EK-L-CP122

MMG*		Workpiece material	Strength/hardness [N/mm ²] [HRC]	Cutting speed v_c (m/min)	Feed f_z (mm/z)	
				Internal cooling		
P	P1	P1.1	Structural, free-cutting, case hardened and heat-treated steels, non-alloy	< 700	180	0.150
		P1.2	Structural, free-cutting, case hardened and heat-treated steels, non-alloy	< 1200	160	0.120
	P2	P2.1	Nitrided, case hardened and heat-treated steels, alloy	< 900	160	0.150
		P2.2	Nitrided, case hardened and heat-treated steels, alloy	< 1400	140	0.120
	P3	P3.1	Tool, bearing, spring and high-speed steels**	< 800	160	0.150
		P3.2	Tool, bearing, spring and high-speed steels**	< 1000	160	0.150
		P3.3	Tool, bearing, spring and high-speed steels**	< 1500	140	0.120
	P5	P5.1	Cast steel		140	0.120

DZ-L-CP122

MMG*		Workpiece material	Strength/hardness [N/mm ²] [HRC]	Cutting speed v_c (m/min)	Feed f_z (mm/z)	
				Internal cooling		
P	P1	P1.1	Structural, free-cutting, case hardened and heat-treated steels, non-alloy	< 700	180	0.150
		P1.2	Structural, free-cutting, case hardened and heat-treated steels, non-alloy	< 1200	160	0.120
	P2	P2.1	Nitrided, case hardened and heat-treated steels, alloy	< 900	160	0.150
		P2.2	Nitrided, case hardened and heat-treated steels, alloy	< 1400	140	0.120
	P3	P3.1	Tool, bearing, spring and high-speed steels**	< 800	160	0.150
		P3.2	Tool, bearing, spring and high-speed steels**	< 1000	160	0.150
		P3.3	Tool, bearing, spring and high-speed steels**	< 1500	140	0.120
	P5	P5.1	Cast steel		140	0.120

* MAPAL machining groups

** If the alloy parts Cr, Mo, Ni, V, W in total > 8% then select the next highest MAPAL machining group.

AS-L-PU620

MMG*	Workpiece material	Strength/hardness [N/mm ²] [HRC]	Cutting speed v _c (m/min)	Feed f _z (mm/z)	
			Internal cooling		
N	N1	N1.1 Aluminium, non-alloy and alloy < 3 % Si	230	0.150	
		N1.2 Aluminium, alloy ≤ 7 % Si	230	0.150	
		N1.3 Aluminium, alloy > 7-12 % Si	230	0.150	
		N1.4 Aluminium, alloy > 12 % Si	230	0.150	
	N2	N2.1 Copper, unalloyed and low-alloyed	< 300	180	0.150
		N2.2 Copper, alloy	> 300	180	0.150
		N2.3 Brass, bronze, gunmetal	< 1200	180	0.150

EK-L-PU620

MMG*	Workpiece material	Strength/hardness [N/mm ²] [HRC]	Cutting speed v _c (m/min)	Feed f _z (mm/z)	
			Internal cooling		
N	N1	N1.1 Aluminium, non-alloy and alloy < 3 % Si	230	0.150	
		N1.2 Aluminium, alloy ≤ 7 % Si	230	0.150	
		N1.3 Aluminium, alloy > 7-12 % Si	230	0.150	
		N1.4 Aluminium, alloy > 12 % Si	230	0.150	
	N2	N2.1 Copper, unalloyed and low-alloyed	< 300	180	0.150
		N2.2 Copper, alloy	> 300	180	0.150
		N2.3 Brass, bronze, gunmetal	< 1200	180	0.150

The specified cutting values are guide values.

The optimum data for the respective machining task should be determined during the test or machining.

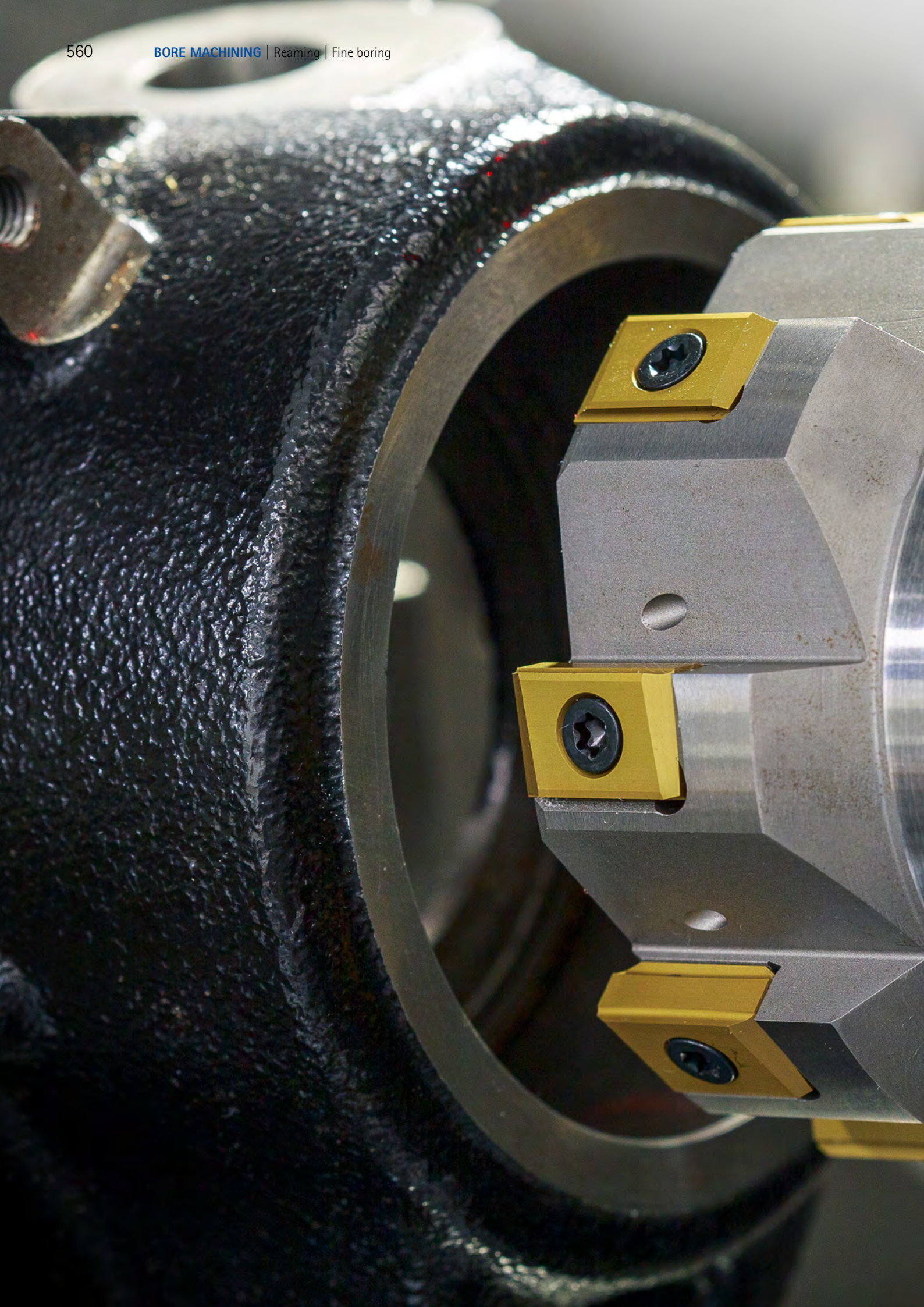

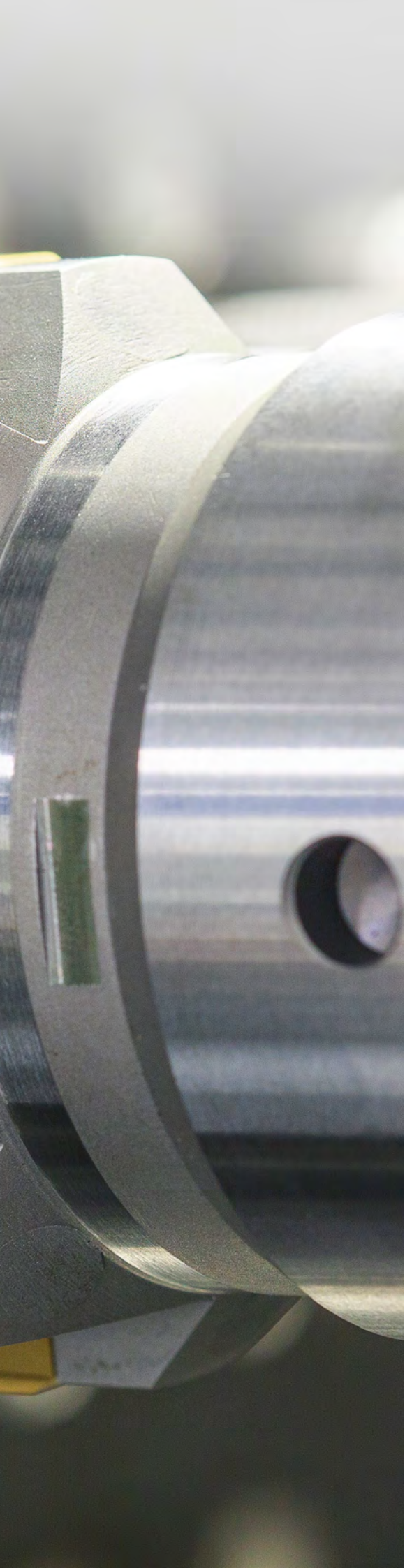

SOLUTIONS FOR LARGE DIAMETERS | SPECIAL SOLUTIONS

Solutions for large diameters

Programme overview	562
HPR400 plus	564
HPR400	568

Special solutions

Tools with guide pads	572
Tools with EasyAdjust system	574
Multi-bladed reamers	576



PROGRAMME OVERVIEW

Multi-bladed high-performance reamers for large diameter ranges

To finely machine bores with large diameters in a defined tolerance range, users are often faced with the question: reaming or finish-boring? On the one hand, it is possible to work significantly faster with multi-bladed reaming tools and they are less sensitive to an interrupted cut. On the other hand, the reconditioning of reamers with fixed inserts is a complex process.

MAPAL offers two HPR systems to optimise this reconditioning process:

HPR400 plus

The focus of the development of the HPR400 plus reamers was on increasing cost-effectiveness by means of efficient reconditioning. The multi-bladed tools impress due to high cost-effectiveness thanks to fast application data and simple insert changing on site by the customer. This is possible due to the highly accurate insert seats. As such the logistics costs for transport to the manufacturer are completely eliminated. Tool stock and reconditioning costs remain low. Indexable inserts with four cutting edges guarantee optimal cutting material utilisation.

HPR400

Simple on-site insert changing

In order to reduce the number of tools in circulation and the stock, MAPAL offers the HPR400 system, in which the cutting edge can be changed on site by the customer. The tool bodies do not have to be reprocessed; only the storage costs for the required cutting edges are incurred.

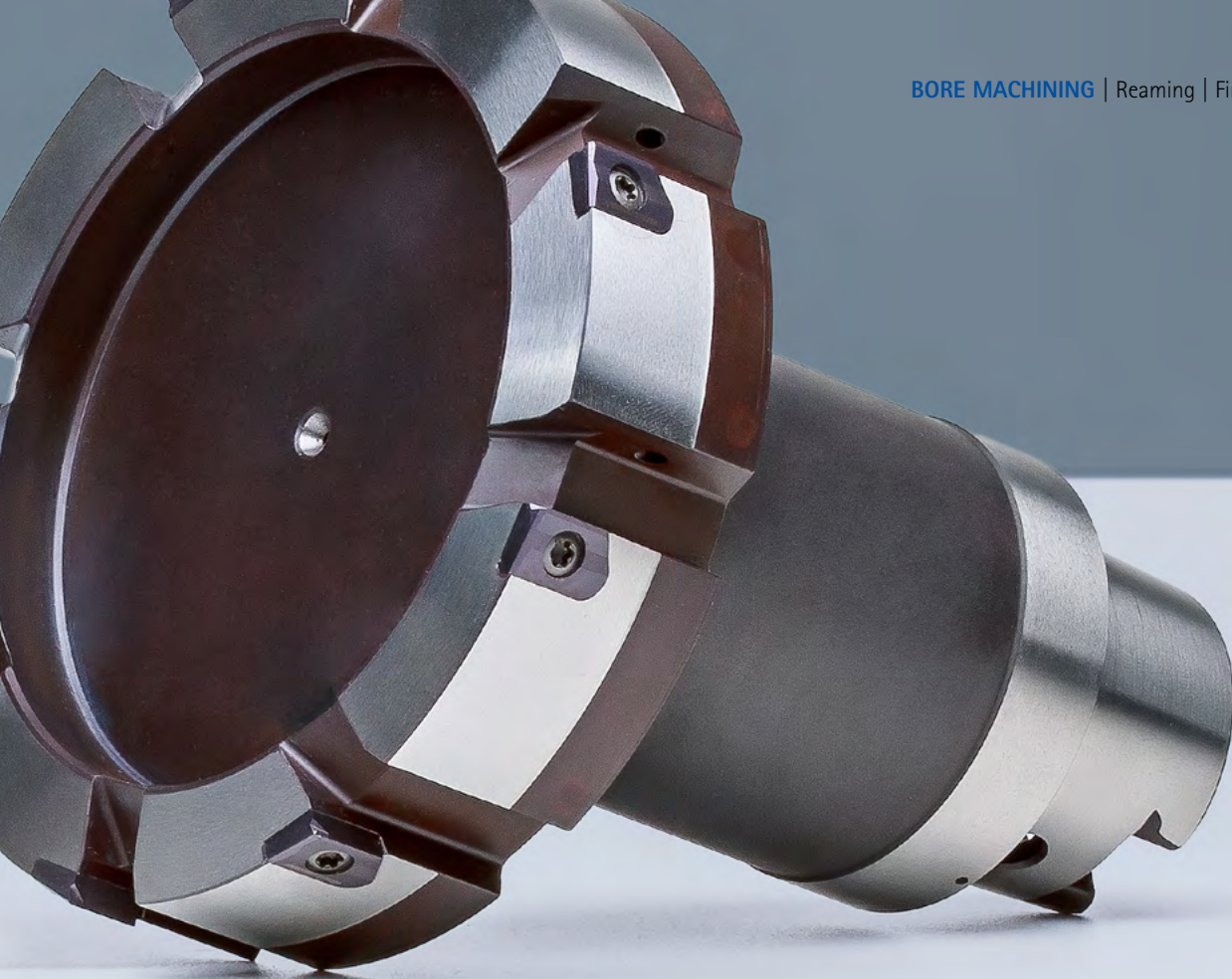

HPR

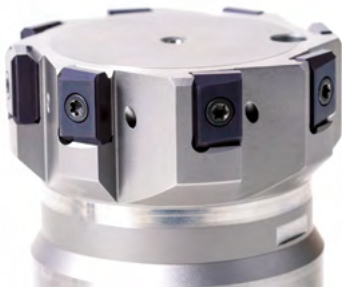

HPR400 plus

Four cutting edges for high cost-effectiveness.

- No logistics costs for transport to the manufacturer for reconditioning
- IT7 tolerance achievable from diameter 65.000 mm

Ø range: 63.000 - 319.999 mm



HPR400

Simple on-site insert changing.

- Incorrect installation of the cutting edge is ruled out; the cutting edges can be fitted in any position.

Ø range: 63.000 - 319.999 mm



HPR400 plus

No setting and four cutting edges significantly reduce cost per part

Increasing cost-effectiveness through efficient reconditioning was the focus of the development of the HPR400 reamers. The multi-bladed tools impress due to high cost-effectiveness thanks to fast application data and simple insert changing on site by the customer. This is possible due to the highly accurate insert seats. As such the logistics costs for transport to the manufacturer are completely eliminated. Tool stock and reconditioning costs remain low.

To further increase cost-effectiveness during the machining of large diameters, the indexable inserts on the newly developed HPR400 plus no longer have a single cutting – instead they have four cutting edges. The cutting material is therefore optimally utilised. The four-blade indexable inserts are manufactured so precisely that they can be turned or changed on site by the customer's employees without any problems.

The inventory of inserts can be further reduced; the reconditioning costs and therefore the cost per part drop.

AT A GLANCE

- Insert change on site by the customer
- Four instead of the previous single cutting edge
- Diameter range 63.000 to 319.999 mm
- Can be used universally with all materials
- Cutting material is optimally utilised
- No logistics costs for transport to the manufacturer for reconditioning
- Low tool stock and low reconditioning costs
- Indexable inserts simple to rotate and change

Tool features in detail

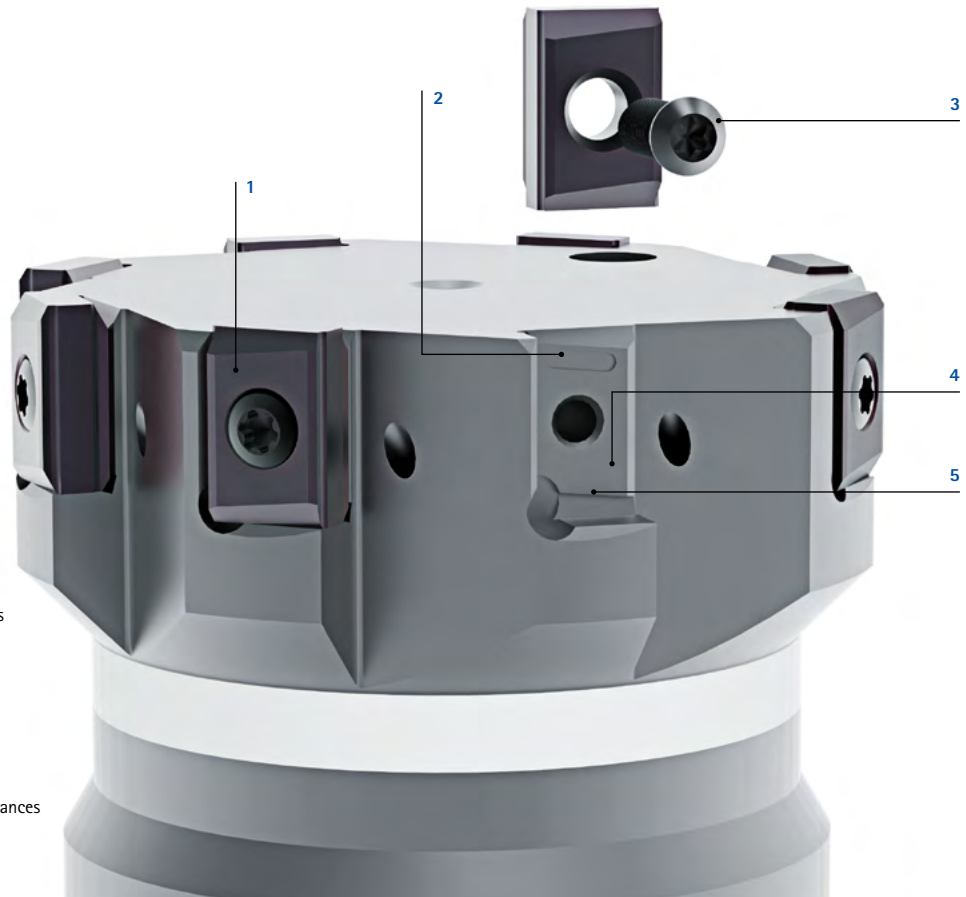

1 Indexable insert

Four cutting edges for high cost-effectiveness

2 Wiper pocket

For removing microsoiling

3 TORX® PLUS screw

4 Insert seat

Highly accurate for optimal adherence to tolerances

5 Particle slot

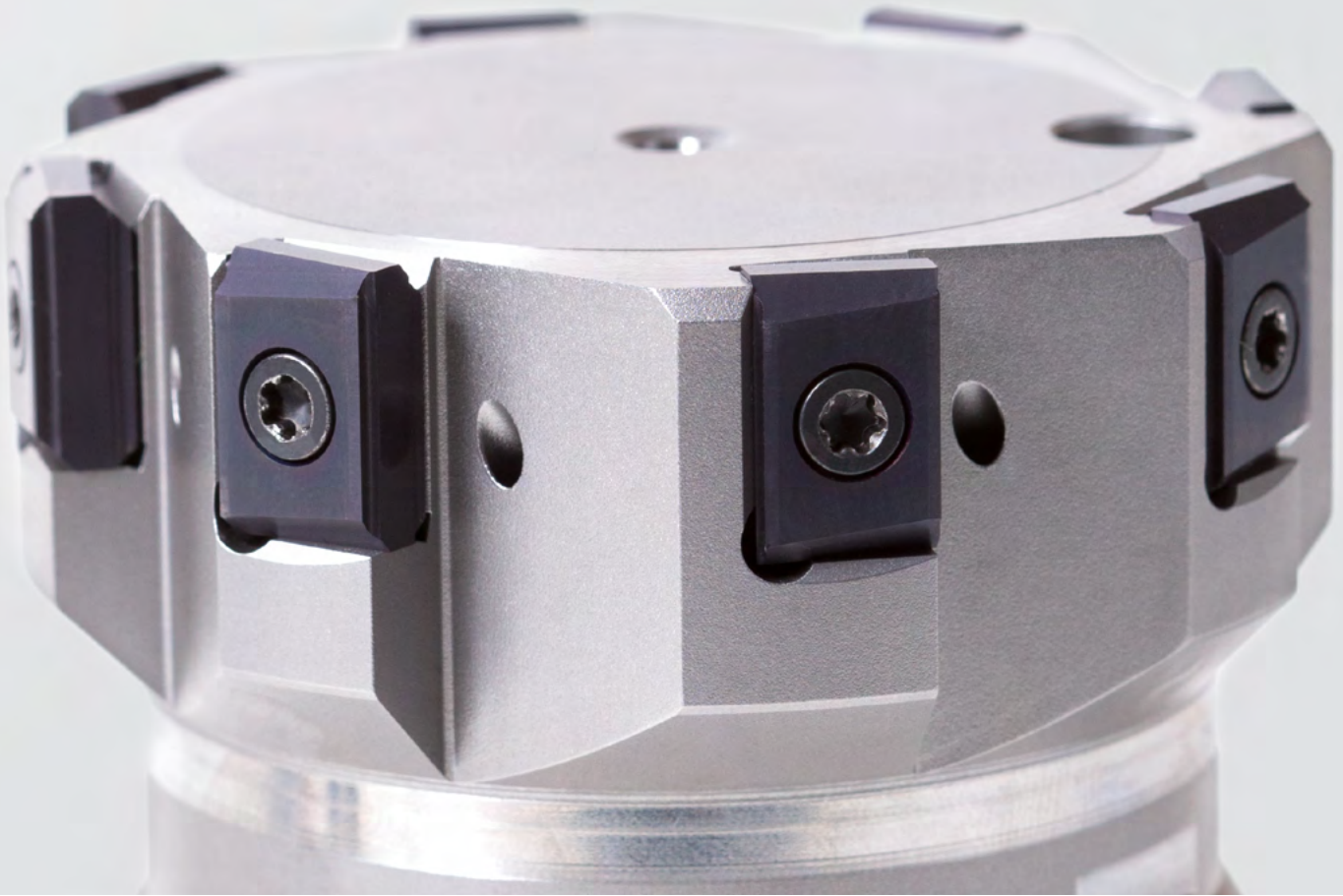

HPR400 plus



Insert change on site by the customer

- Easy handling
- Accurate insert change thanks to highly accurate insert seat
- No setting necessary



Four cutting edges for high cost-effectiveness

- Different cutting materials and leads available
- Special blades on request

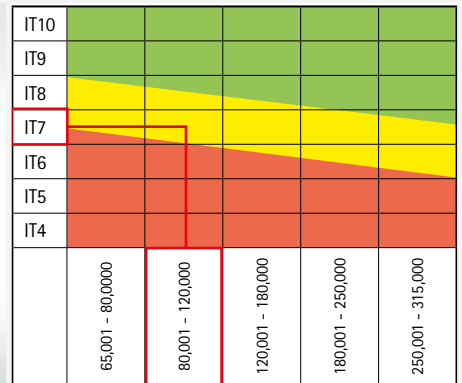

IT7 tolerance from diameter 65 mm

- Tolerance class IT7 can be easily realised on larger diameters, as well as smaller tolerances for larger diameters

High-performance reamer HPR400 plus

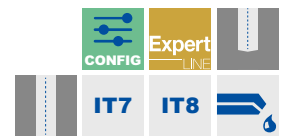
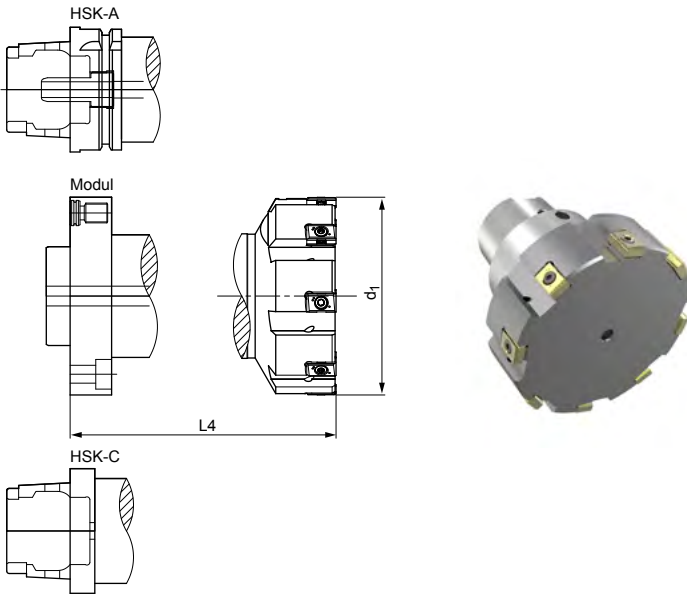

Dimensions of HPR400 plus tool body

d ₁	z	Connection size				
		HSK-C	HSK-A	Projection length L4 freely selectable	Module	Projection length L4 freely selectable
63.000 - 79.999	8	HSK-C063	HSK-A063	65-290	60	65-320
80.000 - 99.999	8	HSK-C063	HSK-A063	65-290	80	65-320
100.000 - 124.999	8	HSK-C080	HSK-A080	75-330	100	75-320
125.000 - 159.999	8	HSK-C080	HSK-A080	75-330	100	75-320
160.000 - 199.999	8	HSK-C080	HSK-A080	75-330	140	90-320
200.000 - 249.999	10	HSK-C100	HSK-A100	90-300	140	90-320
250.000 - 319.999	12	HSK-C100	HSK-A100	90-300	140	90-320

Data are only guide values, deviations on request

Configurable features



- Diameter freely selectable in increments of 0.001 mm
- Can be ordered from tolerance IT7 – IT8 (min 40 µm)
- All common connections can be used
- Can be carried out as multi-stage tool
- Can be combined with MAPAL tool systems und MAPAL connection systems
- MQL-compatible



Specification:
Available upon request

Accessories and spare parts	Material number
Torque wrench set 1-5 Nm	30415174
Spare screw M4x12	10018468

Indexable inserts for HPR400 plus



Cutting edges preferred series

Diameter range	Material number
63,000 - 79,999	30968871
80,000 - 99,999	30933385
100,000 - 124,999	30968884
125,000 - 159,999	30968891
160,000 - 199,999	30968898
200,000 - 249,999	30968905
250,000 - 319,999	30968912

Design:

Diameter range: 63.000 - 319.999
 Four cutting edges
 Lead: 45° x 0.55 mm
 Cutting material: HC419



Cutting edges preferred series

Diameter range	Material number
63,000 - 79,999	31315612
80,000 - 99,999	31315613
100,000 - 124,999	31149561
125,000 - 159,999	31315614
160,000 - 199,999	31315615
200,000 - 249,999	31315617
250,000 - 319,999	31315618

Design:

Diameter range: 63.000 - 319.999
 Four cutting edges
 Lead: 30° x 0.60 mm +
 peeling angle
 Cutting material: CP004
 Workpiece material group K
 Suitable for surface Ra < 2 µm

Dimensions in mm.

Additional leads and cutting materials available upon request

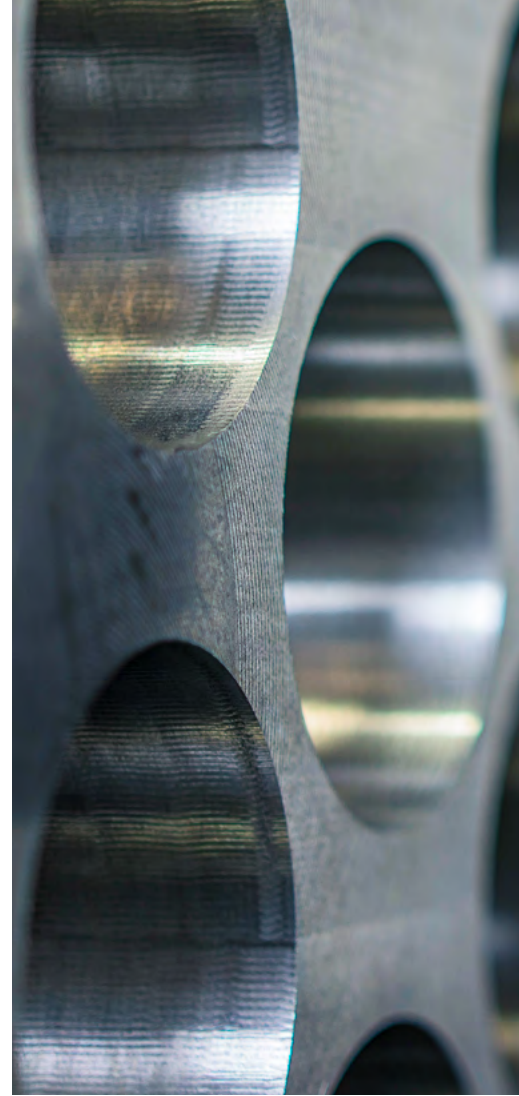

HPR400

Reaming in larger diameters with simple on-site insert changing

Due to the special, high-accuracy insert seats of the HPR400 series, users can replace the inserts on-site themselves using a torque wrench with this system. Incorrect installation is ruled out, as only one installation position is possible and the inserts can be fitted in any position. As a result, there is no setting effort, or the need to send tools for reconditioning. Users only need to have the inserts from MAPAL in stock. The quantity of tools required is low, as tool bodies do not need to be reconditioned. With minimal effort and a low number of tools in circulation, the user achieves high-accuracy bores with the HPR400.

The cutting edges are optimally adapted to the material and the machining. The HPR400 is available in the diameter range from 63 to 319.999 mm with an hollow shank taper adaptor or MAPAL's own module adaptor. MAPAL

offers various indexable inserts, produced of carbide with or without CVD coating, made of cermet, and tipped with PCD or PcBN.

AT A GLANCE

- Independent insert changing by the user on-site
- Insert installation independent of the seat position
- Reduction in the cost per part
- Reduced coating costs
- Reduction in the number of tools in circulation
- All cutting materials useable
- H7 tolerance
- \varnothing 63.000 / 319.999 mm

Tool features in detail

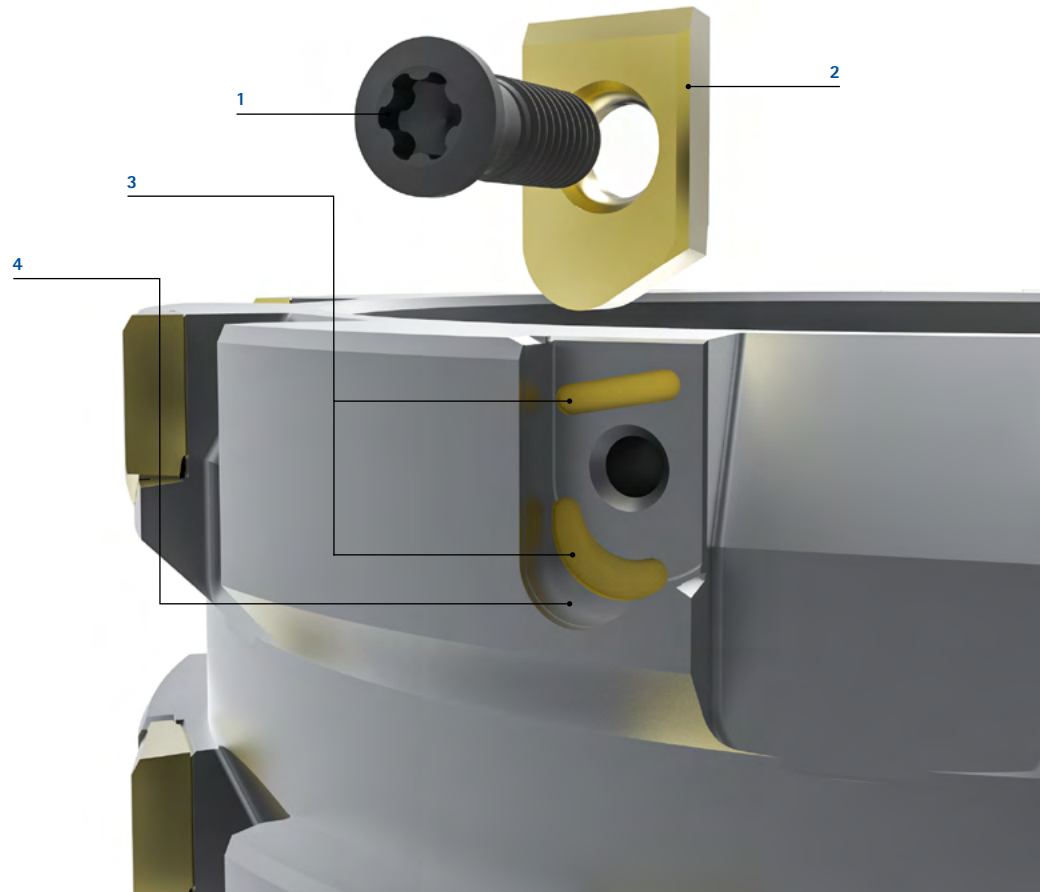

1 TORX® clamping screw

2 Insert

Prismatic shape for optimum investment

3 Wiper pocket

For removing microsoiling

4 Insert seat

Highly accurate for optimal adherence to tolerances

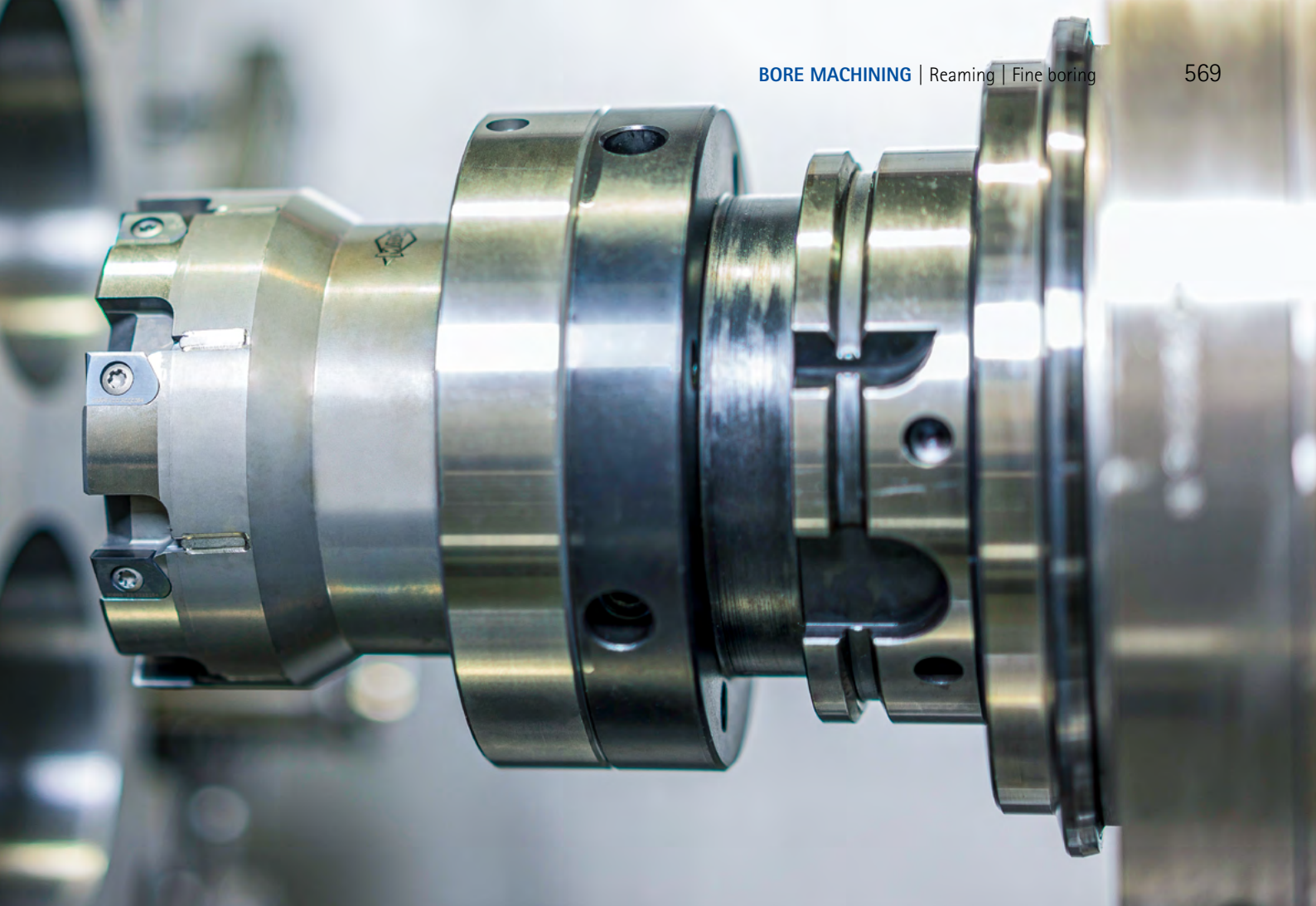

CVD-coated inserts



Optimally suited for reaming cast materials

The CVD-coated cutting materials available for the HPR400, recognisable by the cutting material abbreviation HC, have been specially developed for reaming the tough cast iron materials GJL, GJS and GJV in difficult machining conditions such as interrupted cutting. The CVD coating is characterised by a high level of ductility with good resistant to wear. Up to three times the tool life of existing PVD-coated cutting edges with high process reliability can be achieved with CVD-coated cutting edges. Thanks to the clamping system, almost all other cutting materials can be used in the HPR400 system.

Cost-effective system



Simple on-site insert changing

With the HPR400, MAPAL offers a system where the cutting edge is changed on-site by the customer. The exchangeable cutting edges are pushed axially into the insert seat and fixed by a Torx screw in the high-precision insert seat with process reliability and high precision. The insert assignment is independent of the insert seat. Coating costs are reduced with a simultaneous reduction of the number of tools in circulation.

High-performance reamer HPR400

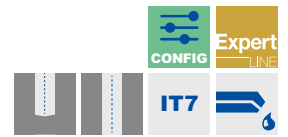
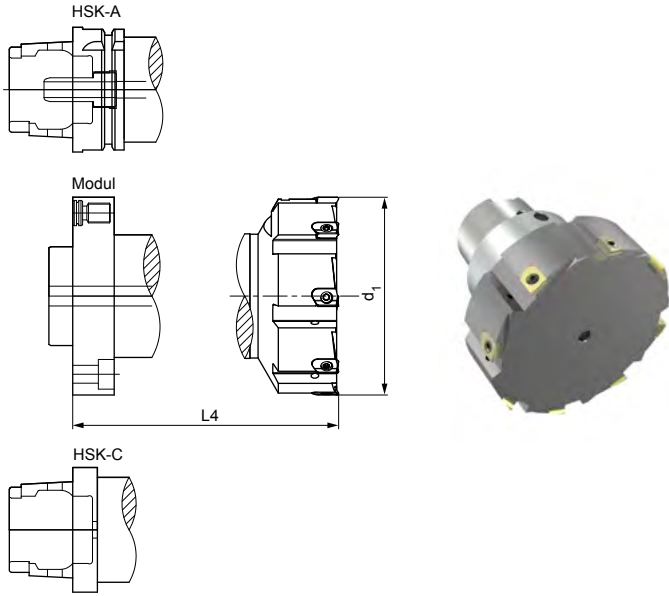

Dimensions for tool body HPR400

d ₁	z	Connection size				
		HSK-C	HSK-A	Projection length L4 freely selectable	Module	Projection length L4 freely selectable
63.000 - 79.999	8	HSK-C063	HSK-A063	65-290	60	65-320
80.000 - 99.999	8	HSK-C063	HSK-A063	65-290	80	65-320
100.000 - 124.999	8	HSK-C080	HSK-A080	75-330	100	75-320
125.000 - 159.999	8	HSK-C080	HSK-A080	75-330	100	75-320
160.000 - 199.999	8	HSK-C080	HSK-A080	75-330	140	90-320
200.000 - 249.999	10	HSK-C100	HSK-A100	90-300	140	90-320
250.000 - 319.999	12	HSK-C100	HSK-A100	90-300	140	90-320

Data are only guide values, deviations on request

Configurable features



- Diameter freely selectable in increments of 0.001 mm
- Can be ordered from tolerance IT7
- Front cut possible
- All common connections can be used
- Can be carried out as multi-stage tool
- Can be combined with MAPAL tool systems und MAPAL connection systems
- MQL-compatible



Specification:
Available upon request

Accessories and spare parts	Material number
Torque wrench set 1-5 Nm	30415174
Spare screw M3.5x9	10105078

Indexable insert for HPR400



Cutting edges preferred series

Diameter range	Material number
63,000 - 79,999	30916603
80,000 - 99,999	30794390
100,000 - 124,999	30809550
125,000 - 159,999	30788089
160,000 - 199,999	30809531
200,000 - 249,999	30938712
250,000 - 319,999	30931640

Design:

Diameter range: 63.000 - 319.999
 A cutting edge
 Lead: 45 ° x 0.55 mm
 Cutting material: HC419



Cutting edges preferred series

Diameter range	Material number
63,00 - 79,99	31026872
80,00 - 99,99	31129899
100,00 - 124,99	31049249
125,00 - 159,99	30690096
160,00 - 199,99	31149706
200,00 - 249,99	31149707
250,00 - 319,99	31129911

Design:

Diameter range: 63.000 - 319.999
 A cutting edge
 Lead: 30° x 0.60 mm +
 peeling angle
 Cutting material: CP004
 Workpiece material group K
 Suitable for surface Ra < 2 µm

Dimensions in mm.

Additional leads and cutting materials available upon request

SPECIAL SOLUTIONS

Tools with guide pads

User-specific tool solutions

- 1 Boring tool with guide pads with ISO cartridges in lightweight construction produced of aluminium for machining a transmission housing
- 2 Fine boring tool with indexable insert system for combined internal and external machining of a planetary carrier
- 3 External reamer with EasyAdjust system and TEC inserts for machining an exhaust manifold with MAPAL floating holder
- 4 Fine boring tool with ISO leading stage and connection for HPR reaming head for machining a cylinder block
- 5 Fine boring tool with EasyAdjust system with HX cutting edges for machining a crankshaft bearing bore
- 6 Fine boring tool in lightweight construction as welded design for machining a transmission housing
- 7 Multi-stage and multi-bladed fine boring tool in lightweight construction produced of titanium for machining a steering housing
- 8 Fine boring tool designed for minimum quantity lubrication (MQL) with indexable insert system for machining valve housing
- 9 Multi-stepped fine boring tool with indexable insert system with contour cutting and facing of pump housing
- 10 Fine boring tool with indexable insert system for combined machining of a planetary carrier
- 11 Tangential fine boring tool for semi-finishing with modular cutting head for machining a crankshaft bearing bore
- 12 External reamer with indexable insert system additionally manufactured as a lightweight construction for machining a valve body pin



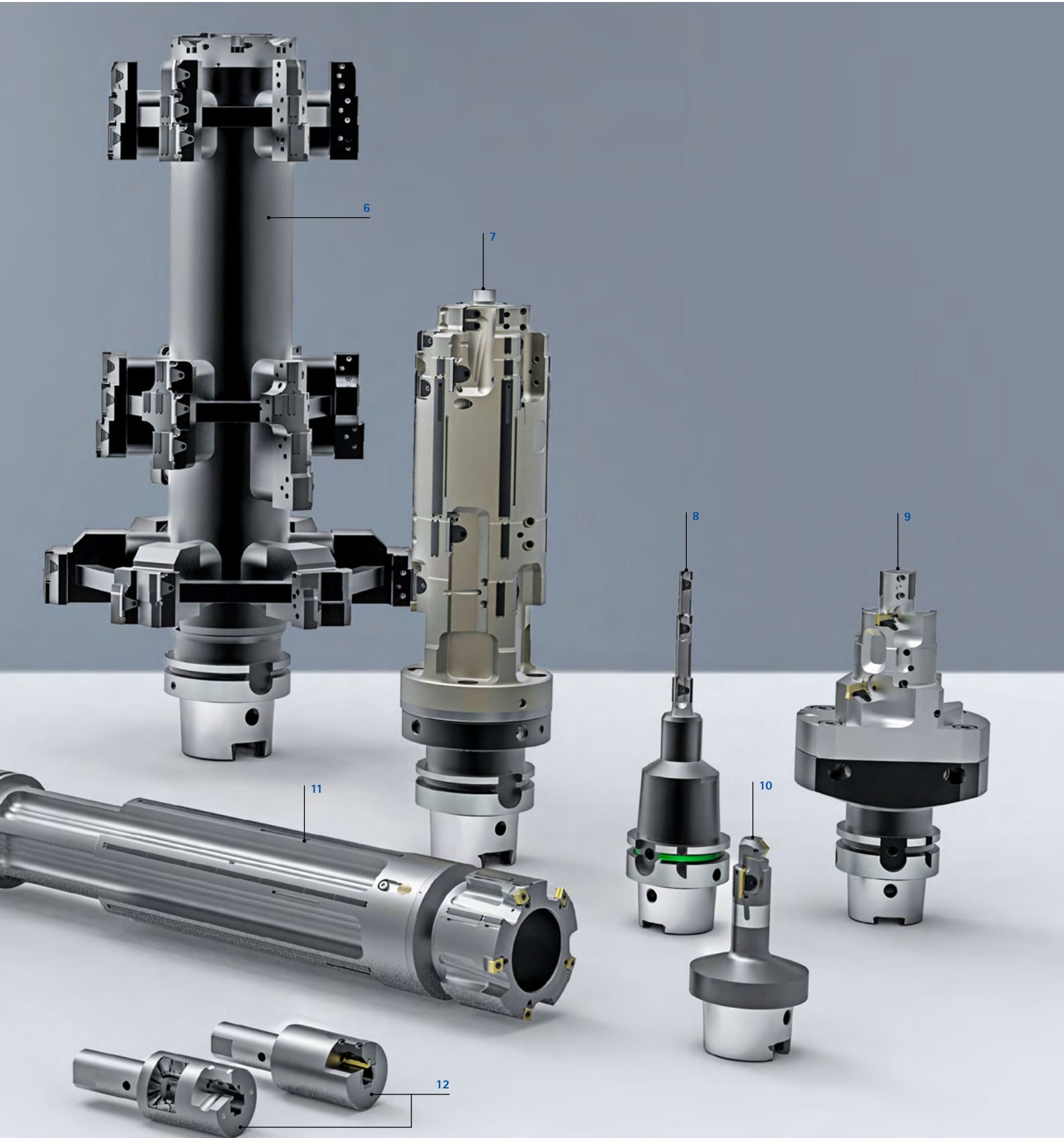

SPECIAL SOLUTIONS

Tools with EasyAdjust system

Special solutions with the EasyAdjust system

- 1 Combination tools for rough machining and fine machining of large and small pin bores. With ISO cutting edges for pre-machining and EasyAdjust system for fine machining
- 2 Custom tools with the EasyAdjust system with four TEC inserts ($z = 4$) and guide pads arranged on one side for machining a heavily interrupted cut in a pump housing produced of GJS-400
- 3 Six-blade tool with 4+2 distribution of cuts and EasyAdjust system with HX cutting edges for machining a cylinder bore
- 4 Multi-stage fine boring tools with the EasyAdjust system with TEC inserts for machining a blind bore in transmission and valve housings with IT5 and IT6 requirements for dimensional accuracy
- 5 Tools for semi-finishing and finishing a crankshaft bearing bore produced of the bi-metal combination aluminium-GJL
- 6 External reamer with the EasyAdjust system with TEC inserts, replaces conventional turning of a part produced of GJS with better dimensional accuracy

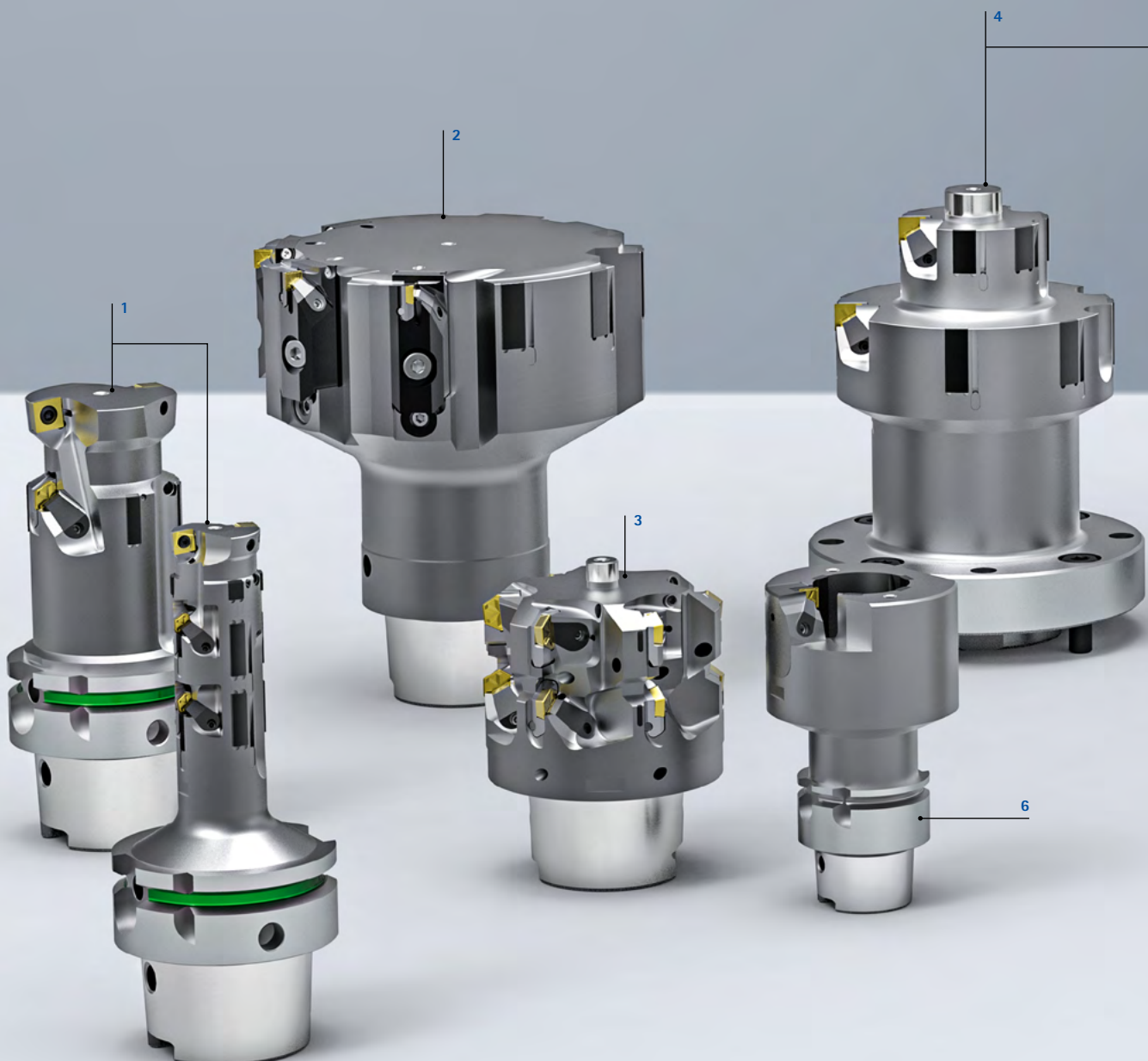



SPECIAL SOLUTIONS

Multi-bladed reamer



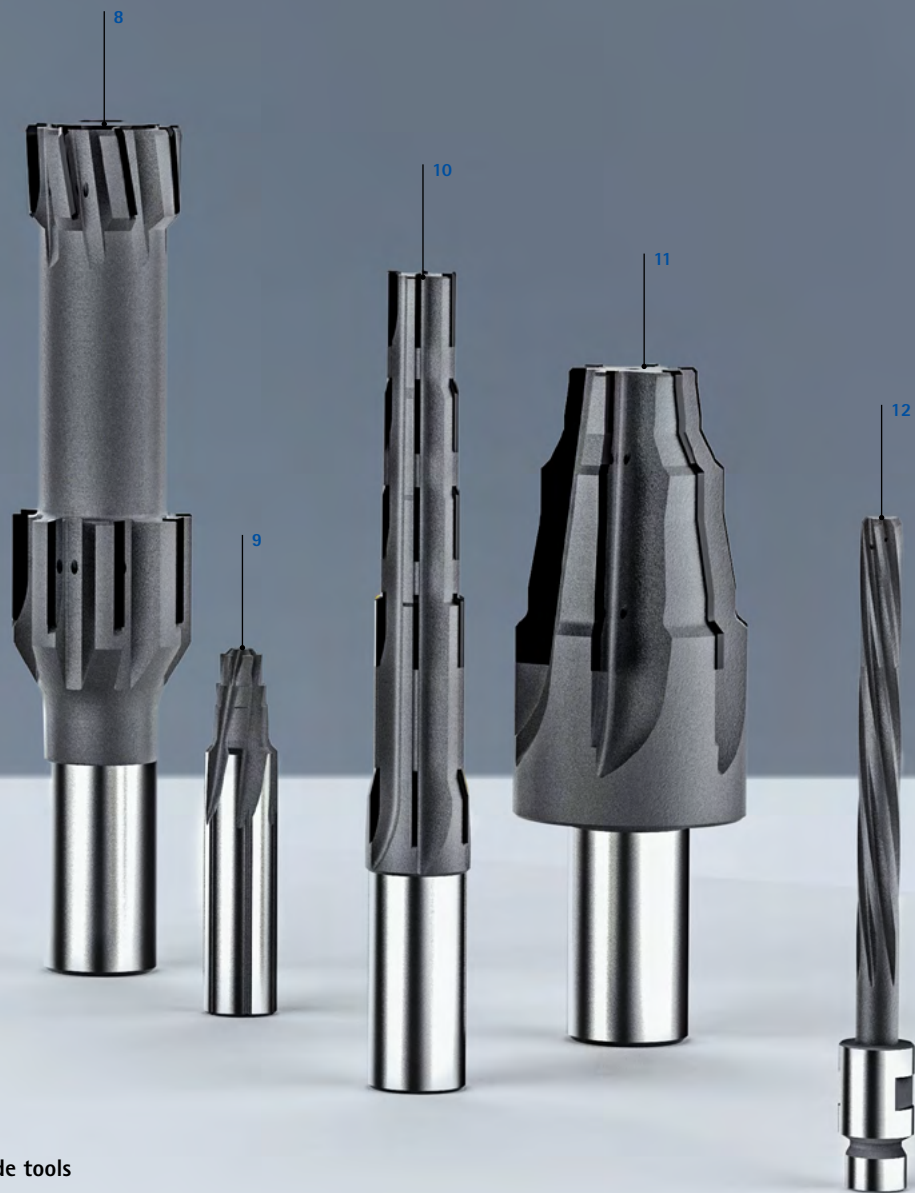

Custom solutions – solid carbide tools

- 1 Two-stage custom tool with brazed blades for machining a hydraulic housing produced of EN-GJS-500-7
- 2 Multi-stage coated solid carbide custom tool with chamfer and radius machining for machining on a steel cylinder holder
- 3 Coated solid carbide step reamer for machining the injector bore in a cylinder head
- 4 Coated solid carbide step reamer for fine machining a contour of the spark plug bore in EN-GJL-250
- 5 Two-stage solid carbide step reamer with additional chamfering for machining a high-pressure pump produced of stainless steel
- 6 HSS machine taper reamer with MK shank
- 7 Solid carbide step reamer with VA geometry for machining a stainless steel valve block
- 8 Two-stage custom reamer with brazed cermet blades with combined straight and left-hand fluted design
- 9 Coated multi-stage solid carbide reamer with internal cooling on the shank for machining a rail
- 10 Step reamer with brazed half-round embedded cermet blades for machining a steel nozzle holder
- 11 Coated carbide-tipped form reamer for machining special turned parts
- 12 High-performance reamer with blunt brazed solid carbide head with custom connection for aerospace for machining a titanium, aluminium and high-alloy steel rivet bore combination

SPECIAL SOLUTIONS

HPR – High-performance reamer





HPR custom solutions

- 1 Special solution with modular HPR multi-bladed ring and solid carbide step reamer with additively manufactured tool holder with hydraulic clamping technology for internal and external clamping for valve seat machining
- 2 Multi-stage, modular combination tool with integrated CFS connection for fixed brazed CPR tool with ISO tangential inserts for pre-machining and HPR300 system for fine machining a brake caliper
- 3 Multi-stage PCD-tipped custom tool with countersink step for machining a part in the aerospace industry
- 4 Multi-stage HPR custom tool with HFS connection for machining the bore and contour countersink of a turbocharger produced of GJL250
- 5 Multi-stepped custom tool for machining housings with tangentially arranged reaming cutting edge
- 6 Custom tool for machining a rivet bore in the aerospace industry
- 7 Right-hand cutting tool for blind bore machining
- 8 Multi-stepped custom tool with special blade geometries and HFS connection
- 9 Custom tool in fixed design with brazed cutting edges for step machining of face and chamfer transitions of the actuator bore in the brake caliper

SPECIAL SOLUTIONS

Multi-bladed reamer for large diameters

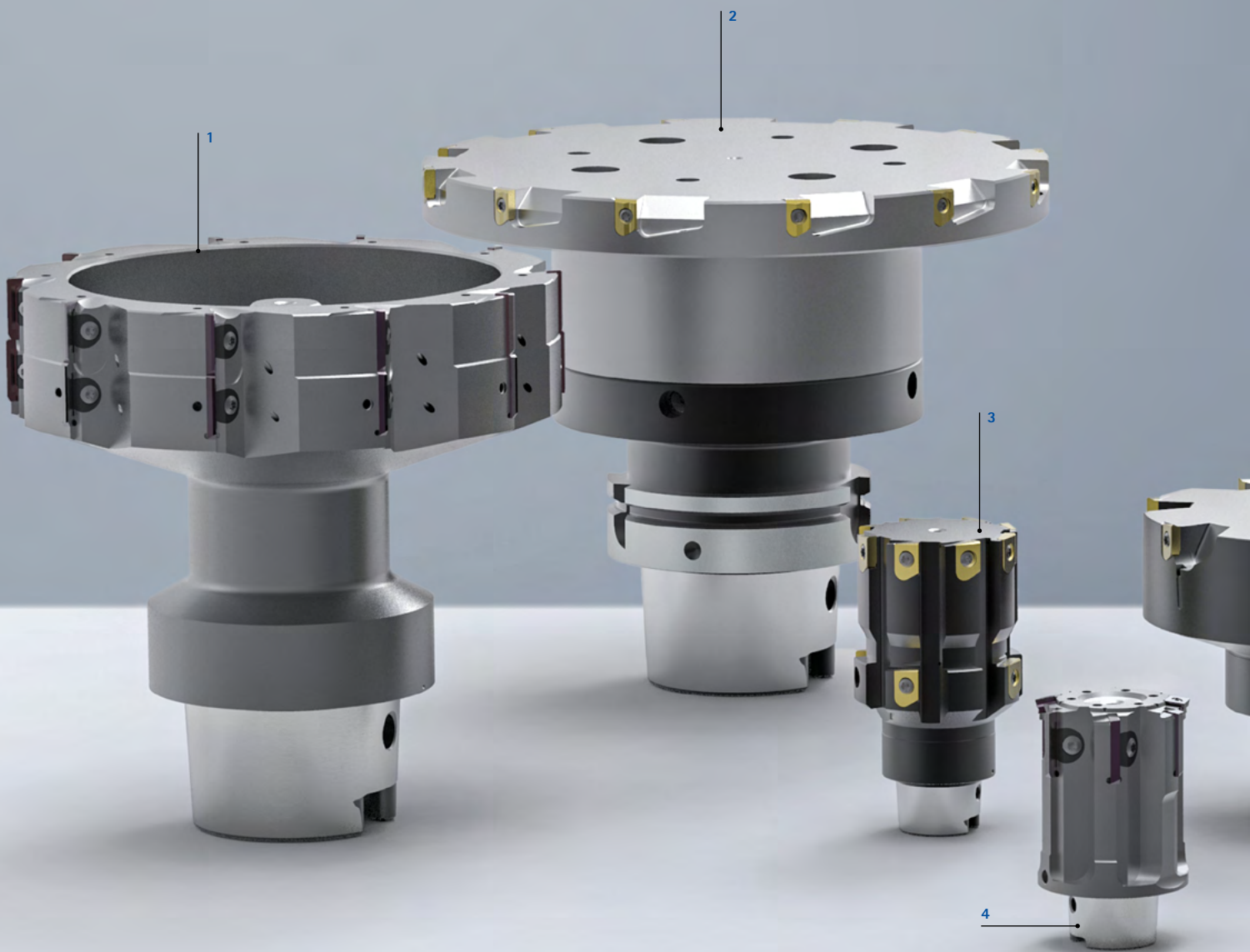

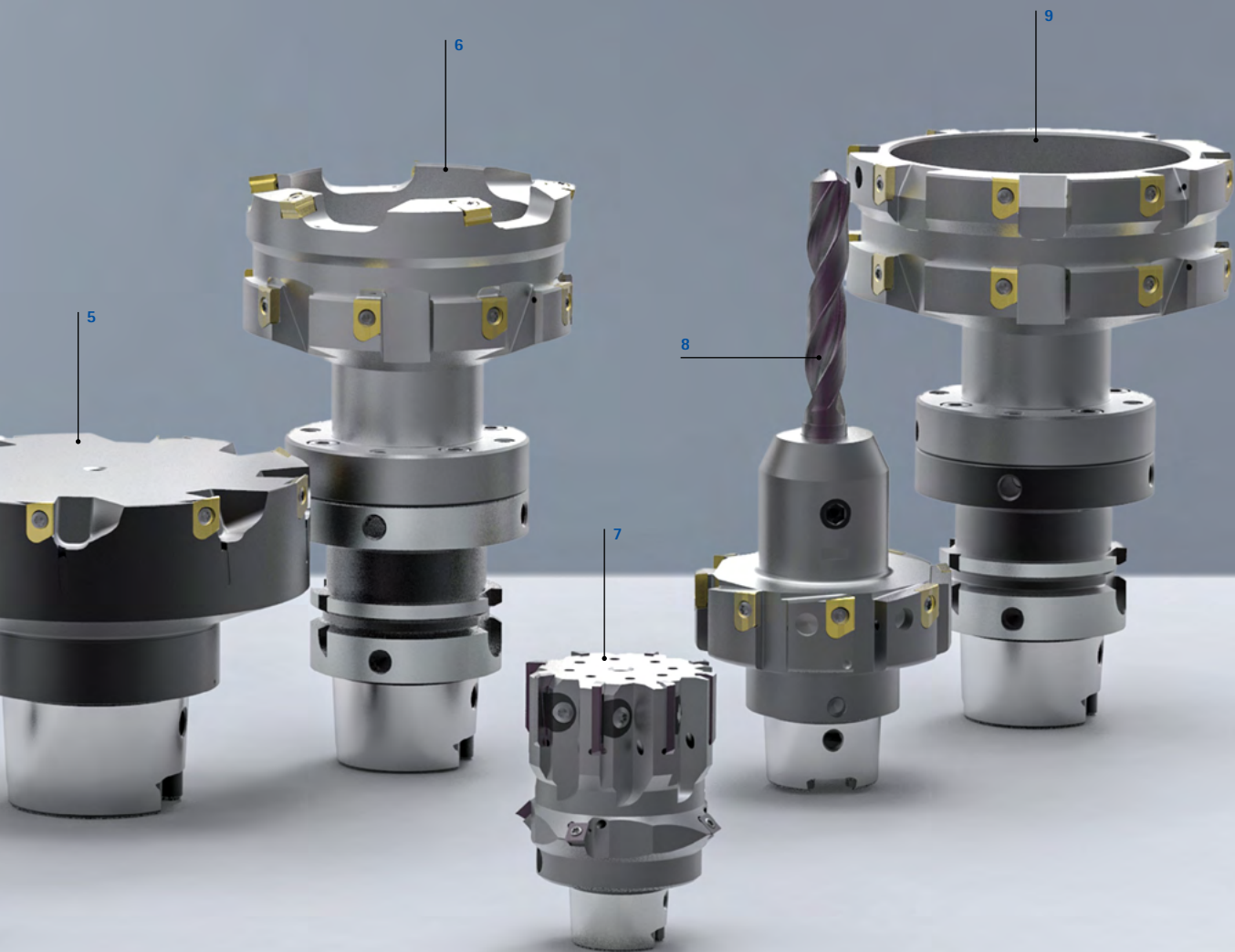

HPR300 and HPR400 custom solutions

- 1 Two-stage HPR300 custom solution for machining the bearing bore of a transmission housing
- 2 HPR400 with CVD-coated cutting edges with a diameter of 160 mm for machining a differential housing with alignable module interface
- 3 Two-stage HPR400 tool with eight blades for the piston bore and four cutting edges for the control cut of a brake caliper
- 4 Combination tool with ISO tangential inserts for pre-machining and HPR300 with PCD-tipped cutting edges for fine machining a brass bush
- 5 HPR400 custom tool for axle bridge bore produced of GJS-400 with CVD special cutting edges for bearing seat machining and axial grooving
- 6 Combination tool in lightweight design with alignable module interface on hollow shank taper adapter (HSK-A) for machining a bevel gear housing. With ISO tangential inserts for pre-machining and HPR400 system for fine machining
- 7 HPR300 with chamfer machining
- 8 Combination tool with solid carbide drill as insert solution and HPR400 reaming stage for machining a swivel bearing
- 9 HPR400 multi-stage tool in lightweight design with alignable module interface for machining a bevel gear drive housing



COUNTERSINKING

Countersinking using extremely unequally spaced countersinks. Quiet, fast and precise for optimal countersinking.



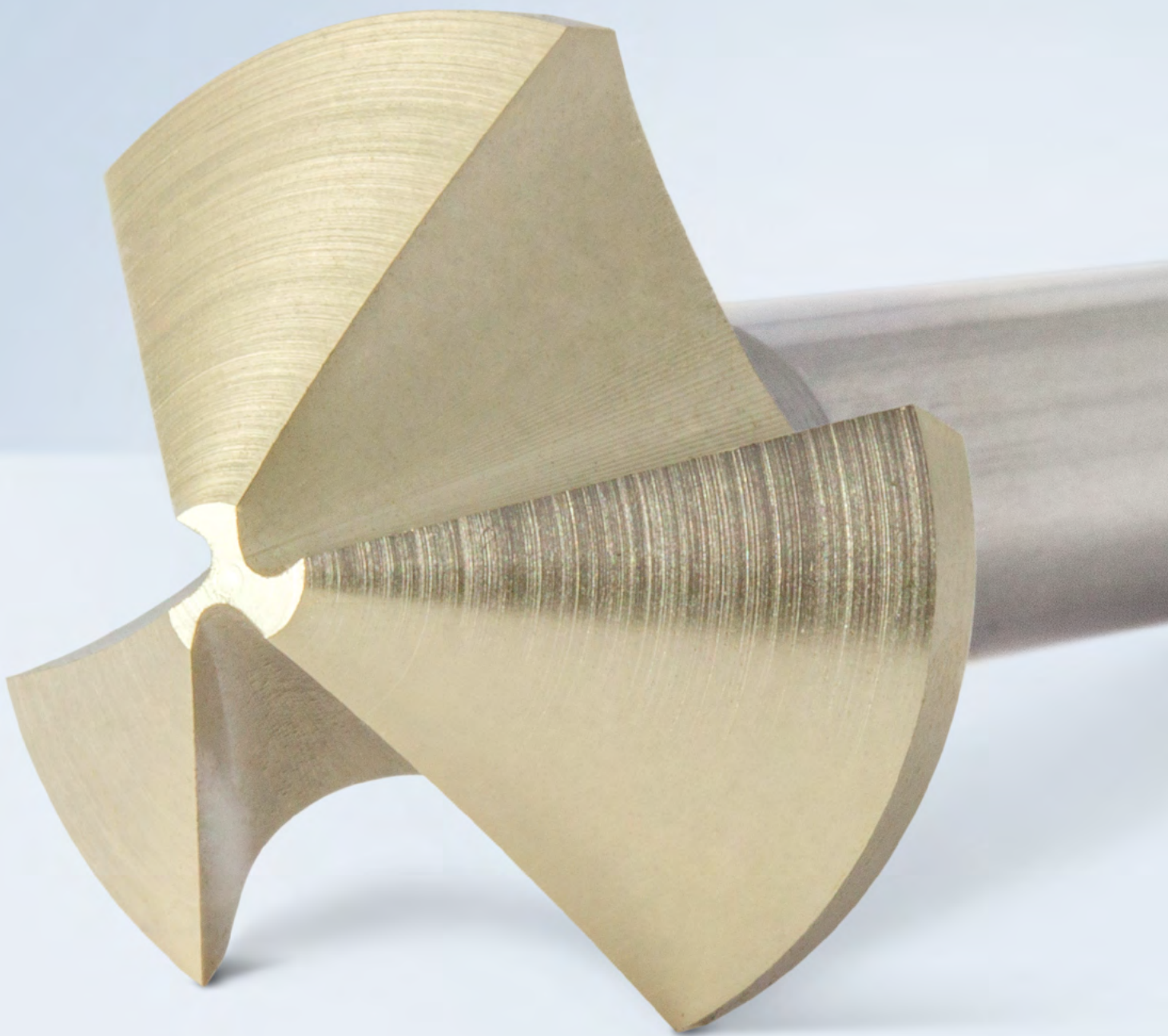

COUNTERSINKS WITH EXTREMELY UNEQUAL SPACING

Introduction

Technology 586

Countersink

HSS variant, coated 588

Solid carbide variant, coated 589





COUNTERSINKS WITH EXTREMELY UNEQUAL SPACING

Finally, it can be quiet, fast and accurate

Every machining process has latent potential for boosting productivity. There is significant potential for improvement even in machining operations that seem secondary. This is proven by the countersinks from MAPAL.

The countersinks operate with significantly reduced axial forces. Their cutting edges are unequally spaced. With the selected spacing, the axial force is reduced by more than 50 percent and the radial force by 25 percent, compared to conventional countersinks. The optimised operating conditions create significantly less

vibration in the tool, allowing more accuracy and better surface finishes. The level of precision now achieved by the countersinks directly improves the contact of the bolted and riveted joints, so the joints no longer settle under load after assembly. The reduced load on the machine also increases the tool life. As the tool runs smooth and stable, it can also be operated with higher cutting values. This results in significant time savings.



Tool features in detail

Radial force reduced by 25%

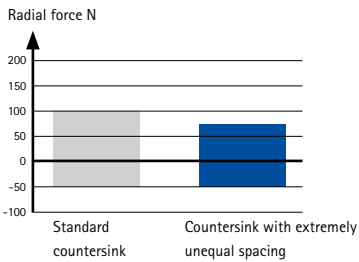

Axial force reduced by 50%

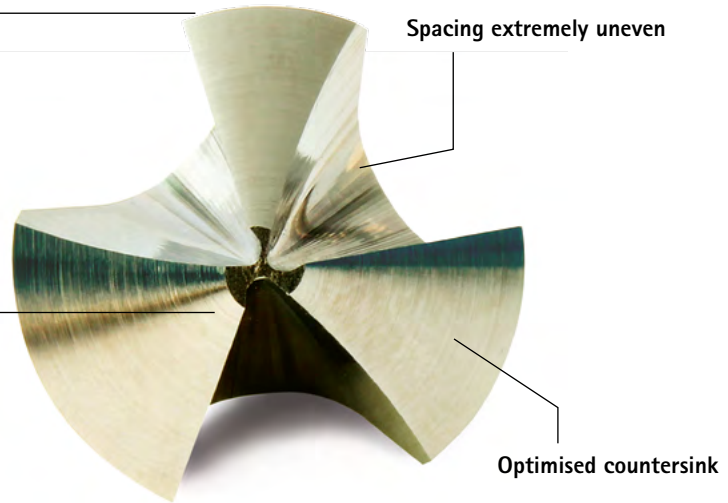
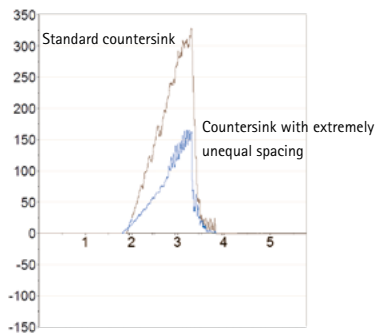

Countersink with extremely unequal spacing



Standard countersink

HSS design, coated



For all common workpiece materials (such as steel, stainless steel or aluminium), the countersinks in HSS design with high-performance coating are the tool of choice. The coating ensures a long tool life. The tools work safely and reliably, even at high cutting speeds. For more demanding workpiece materials, the solid carbide design is recommended.

Solid carbide design, coated



In addition to the high-performance coated HSS designs of countersinks, MAPAL also offers selected diameters in a coated solid carbide version. Along with the advantages of unequal spacing, the solid carbide design offers additional added value during the machining of demanding workpiece materials, such as titanium, high-alloy cast iron, Inconel or CFRP. Longer tool lives and higher cutting speeds are reliably achieved, compared with the coated HSS design.

Special drill designs with countersink step



MAPAL offers the possibility of manufacturing a countersink step for almost all solid carbide drills as a special solution. In this way, both machining operations, drilling and countersinking, can be carried out using a single tool, which reduces downtimes. The most up-to-date manufacturing technologies as well as flexible manufacturing at MAPAL make short delivery times possible for custom solutions worldwide.

90° countersink

HSS design, coated, extremely unequal spacing
COS110

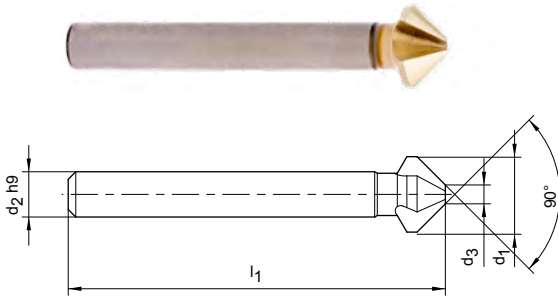

Dimensions					Specification	Order no.
d ₁	d ₂	d ₃	l ₁	z		
4,30	4	1,3	40	3	COS110-0430-335C-SP345	30662991
6,00	5	1,5	45	3	COS110-0600-335C-SP345	30662992
6,30	5	1,5	45	3	COS110-0630-335C-SP345	30633783
8,00	6	2,0	50	3	COS110-0800-335C-SP345	30662993
8,30	6	2,0	50	3	COS110-0830-335C-SP345	30662994
10,00	6	2,5	50	3	COS110-1000-335C-SP345	30662996
10,40	6	2,5	50	3	COS110-1040-335C-SP345	30633784
11,50	8	2,8	56	3	COS110-1150-335C-SP345	30662997
12,40	8	2,8	56	3	COS110-1240-335C-SP345	30662998
15,00	10	3,2	60	3	COS110-1500-335C-SP345	30662999
16,50	10	3,2	60	3	COS110-1650-335C-SP345	30633786
19,00	10	3,5	63	3	COS110-1900-335C-SP345	30663000
20,50	10	3,5	63	3	COS110-2050-335C-SP345	30633787
23,00	10	3,8	67	3	COS110-2300-335C-SP345	30663001
25,00	10	3,8	67	3	COS110-2500-335C-SP345	30633788
31,00	12	4,2	71	3	COS110-3100-335C-SP345	30663003



Countersink set

d ₁	Specification	Order no.
6.30 - 25.00	COS110-6.3-25-335C-SP345-SET Set consists of ø 6.30 mm ø 10.4 mm ø 16.5 mm ø 20.5 mm ø 25.0 mm	30634356

Dimensions in mm.
For cutting data recommendations, see end of chapter.

90° countersink

Solid carbide design, coated, extremely unequal spacing
COS110

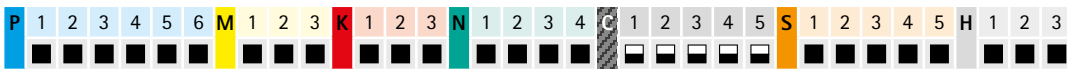
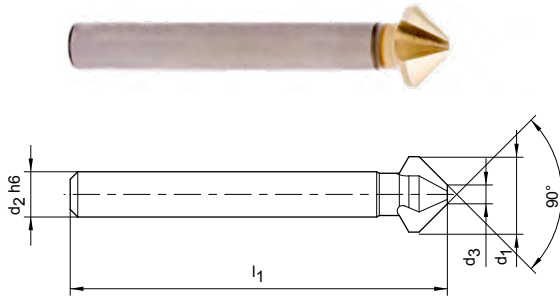

Dimensions					Specification	Order no.
d_1	d_2	d_3	l_1	z		
6,30	5	1,5	45	3	COS110-0630-335C-HP437	30799189
8,30	6	2,0	50	3	COS110-0830-335C-HP437	30799191
10,40	6	2,5	50	3	COS110-1040-335C-HP437	30799192
12,40	8	2,8	56	3	COS110-1240-335C-HP437	30799195
16,50	10	3,2	60	3	COS110-1650-335C-HP437	30799198
20,50	10	3,5	63	3	COS110-2050-335C-HP437	30799199
25,00	10	3,8	67	3	COS110-2500-335C-HP437	30799201
31,00	12	4,2	71	3	COS110-3100-335C-HP437	30799203

Dimensions in mm.

For cutting data recommendations, see end of chapter.

Cutting data recommendations for countersinks

Countersink with extremely unequal spacing – HSS design, coated
Feed and cutting speed

MMG*		Workpiece material	Strength/hardness [N/mm ²] [HRC]
P	P1	P1.1 Structural, free-cutting, case hardened and heat-treated steels, non-alloy	< 700
		P1.2 Structural, free-cutting, case hardened and heat-treated steels, non-alloy	< 1,200
	P2	P2.1 Nitrided, case hardened and heat-treated steels, alloy	< 900
		P2.2 Nitrided, case hardened and heat-treated steels, alloy	< 1,400
	P3	P3.1 Tool, bearing, spring and high-speed steels**	< 800
		P3.2 Tool, bearing, spring and high-speed steels**	< 1,000
		P3.3 Tool, bearing, spring and high-speed steels**	< 1,500
	P4	P4.1 Stainless steels, ferritic and martensitic	
	P5	P5.1 Cast steel	
	P6	P6.1 Stainless cast steel, ferritic and martensitic	
M	M1	M1.1 Stainless steels, austenitic	< 700
		M1.2 Stainless steels, ferritic/austenitic (duplex)	< 1,000
	M2	M2.1 Stainless/heat-resistant cast steel, austenitic	< 700
		M3.1 Stainless cast steel, ferritic/austenitic (duplex)	< 1,000
K	K1	K1.1 Cast iron with lamellar graphite (grey cast iron), GJL	< 300
		K2.1 Cast iron with spheroidal graphite, GJS	< 500
	K2	K2.2 Cast iron with spheroidal graphite, GJS	≤ 800
		K2.3 Cast iron with spheroidal graphite, GJS	> 800
	K3	K3.1 Cast iron with spheroidal graphite, GJV; malleable cast iron, GJM	< 500
		K3.2 Cast iron with spheroidal graphite, GJV; malleable cast iron, GJM	> 500
N	N1	N1.1 Aluminium, unalloyed and alloyed < 3 % Si	
		N1.2 Aluminium, alloyed ≤ 7 % Si	
		N1.3 Aluminium, alloyed > 7-12 % Si	
		N1.4 Aluminium, alloyed > 12 % Si	
	N2	N2.1 Copper, non-alloy and low-alloy	< 300
		N2.2 Copper, alloy	> 300
		N2.3 Brass, bronze, gunmetal	< 1,200
	N4	N4.1 Plastic, thermoplastics	
		N4.2 Plastic, thermosets	
		N4.3 Plastic, foams	
S	S1	S1.1 Titanium, titanium alloys	< 400
		S2.1 Titanium, titanium alloys	< 1,200
	S2	S2.2 Titanium, titanium alloys	> 1,200
		S3.1 Nickel, non-alloy and alloy	< 900
	S3	S3.2 Nickel, non-alloy and alloy	> 900
		S4.1 High-temperature super alloy Ni, Co and Fe-based	
S5	S5.1 Tungsten and molybdenum alloys		
H	H1	H1.1 Hardened steel/cast steel	< 44
		H1.2 Hardened steel/cast steel	< 55

* MAPAL machining groups

** If the alloy parts Cr, Mo, Ni, V, W in total > 8 %, then select the next highest MAPAL machining group.

Next page:
Solid carbide design

	ø < 5 [mm]		ø < 5-8 [mm]		ø < 8-12 [mm]		ø < 12-16 [mm]		ø < 16-20 [mm]		ø < 20-25 [mm]		ø < 25-31 [mm]	
	v _c [m/min]	f [mm]	v _c [m/min]	f [mm]	v _c [m/min]	f [mm]	v _c [m/min]	f [mm]	v _c [m/min]	f [mm]	v _c [m/min]	f [mm]	v _c [m/min]	f [mm]
	40	0.06	40	0.08	40	0.10	40	0.12	40	0.14	40	0.18	40	0.22
	30	0.04	30	0.06	30	0.08	30	0.10	30	0.12	30	0.14	30	0.18
	30	0.04	30	0.06	30	0.08	30	0.10	30	0.12	30	0.14	30	0.18
	12	0.03	12	0.04	12	0.05	12	0.06	12	0.08	12	0.10	12	0.12
	30	0.04	30	0.06	30	0.08	30	0.10	30	0.12	30	0.14	30	0.18
	12	0.03	12	0.04	12	0.05	12	0.06	12	0.08	12	0.10	12	0.12
	15	0.04	15	0.05	15	0.06	15	0.07	15	0.08	15	0.09	15	0.12
	30	0.04	30	0.06	30	0.08	30	0.10	30	0.12	30	0.14	30	0.18
	15	0.04	15	0.05	15	0.06	15	0.07	15	0.08	15	0.09	15	0.12
	15	0.04	15	0.05	15	0.06	15	0.07	15	0.08	15	0.09	15	0.12
	10	0.04	10	0.05	10	0.06	10	0.07	10	0.08	10	0.09	10	0.12
	15	0.04	15	0.05	15	0.06	15	0.07	15	0.08	15	0.09	15	0.12
	20	0.06	20	0.10	20	0.12	20	0.14	20	0.18	20	0.20	20	0.25
	20	0.06	20	0.10	20	0.12	20	0.14	20	0.18	20	0.20	20	0.25
	20	0.06	20	0.10	20	0.12	20	0.14	20	0.18	20	0.20	20	0.25
	20	0.06	20	0.10	20	0.12	20	0.14	20	0.18	20	0.20	20	0.25
	20	0.06	20	0.10	20	0.12	20	0.14	20	0.18	20	0.20	20	0.25
	20	0.06	20	0.10	20	0.12	20	0.14	20	0.18	20	0.20	20	0.25
	50	0.08	50	0.10	50	0.12	50	0.14	50	0.18	50	0.22	50	0.26
	50	0.08	50	0.10	50	0.12	50	0.14	50	0.18	50	0.22	50	0.26
	40	0.08	40	0.10	40	0.12	40	0.14	40	0.18	40	0.22	40	0.26
	40	0.08	40	0.10	40	0.12	40	0.14	40	0.18	40	0.22	40	0.26
	40	0.10	40	0.12	40	0.14	40	0.18	40	0.20	40	0.24	40	0.30
	40	0.10	40	0.12	40	0.14	40	0.18	40	0.20	40	0.24	40	0.30
	40	0.10	40	0.12	40	0.14	40	0.18	40	0.20	40	0.24	40	0.30
	40	0.10	40	0.12	40	0.14	40	0.18	40	0.20	40	0.24	40	0.30
	40	0.10	40	0.12	40	0.14	40	0.18	40	0.20	40	0.24	40	0.30
	10	0.04	10	0.05	10	0.06	10	0.07	10	0.08	10	0.09	10	0.12
	10	0.04	10	0.05	10	0.06	10	0.07	10	0.08	10	0.09	10	0.12
	10	0.04	10	0.05	10	0.06	10	0.07	10	0.08	10	0.09	10	0.12
	10	0.04	10	0.05	10	0.06	10	0.07	10	0.08	10	0.09	10	0.12
	10	0.04	10	0.05	10	0.06	10	0.07	10	0.08	10	0.09	10	0.12
	10	0.04	10	0.05	10	0.06	10	0.07	10	0.08	10	0.09	10	0.12
	10	0.04	10	0.05	10	0.06	10	0.07	10	0.08	10	0.09	10	0.12
	6	0.04	6	0.05	6	0.06	6	0.08	6	0.08	6	0.10		
	6	0.04	6	0.05	6	0.06	6	0.08	6	0.08	6	0.10		

The specified cutting values are guide values.

The optimum data for the respective machining task should be determined during the test or machining.

Cutting data recommendations for countersinks

Countersink with extremely unequal spacing – solid carbide design, coated
Feed and cutting speed

MMG*	Workpiece material	Strength/hardness [N/mm ²] [HRC]
P	P1.1 Structural, free-cutting, case hardened and heat-treated steels, non-alloy	< 700
	P1.2 Structural, free-cutting, case hardened and heat-treated steels, non-alloy	< 1,200
	P2.1 Nitrided, case hardened and heat-treated steels, alloy	< 900
	P2.2 Nitrided, case hardened and heat-treated steels, alloy	< 1,400
	P3.1 Tool, bearing, spring and high-speed steels**	< 800
	P3.2 Tool, bearing, spring and high-speed steels**	< 1,000
	P3.3 Tool, bearing, spring and high-speed steels**	< 1,500
	P4.1 Stainless steels, ferritic and martensitic	
	P5.1 Cast steel	
P6.1 Stainless cast steel, ferritic and martensitic		
M	M1.1 Stainless steels, austenitic	< 700
	M1.2 Stainless steels, ferritic/austenitic (duplex)	< 1000
	M2.1 Stainless/heat-resistant cast steel, austenitic	< 700
M3.1 Stainless cast steel, ferritic/austenitic (duplex)	< 1,000	
K	K1.1 Cast iron with lamellar graphite (grey cast iron), GJL	< 300
	K2.1 Cast iron with spheroidal graphite, GJS	< 500
	K2.2 Cast iron with spheroidal graphite, GJS	≤ 800
	K2.3 Cast iron with spheroidal graphite, GJS	> 800
	K3.1 Cast iron with spheroidal graphite, GJV; malleable cast iron, GJM	< 500
	K3.2 Cast iron with spheroidal graphite, GJV; malleable cast iron, GJM	> 500
N	N1.1 Aluminium, unalloyed and alloyed < 3 % Si	
	N1.2 Aluminium, alloyed ≤ 7 % Si	
	N1.3 Aluminium, alloyed > 7-12 % Si	
	N1.4 Aluminium, alloyed > 12 % Si	
	N2.1 Copper, non-alloy and low-alloy	< 300
	N2.2 Copper, alloy	> 300
	N2.3 Brass, bronze, gunmetal	< 1,200
	N3.1 Graphite > 8 µm	
	N3.2 Graphite < 8 µm	
	N4.1 Plastic, thermoplastics	
N4.2 Plastic, thermosets		
N4.3 Plastic, foams		
C	C1.1 Plastic matrix, aramide fibre-reinforced (AFRP)	
	C1.2 Plastic matrix (thermosetting), CFRP/GFRP	
	C1.3 Plastic matrix (thermoplastic), CFRP/GFRP	
	C2.1 Carbon matrix, carbon fibre-reinforced (CFC)	
	C3.1 Metal matrix (MMC)	
	C4.1 Sandwich construction, honeycomb core	
	C4.2 Sandwich construction, foam core	
	C5.1 Composite (stack), non-metal - non-ferrous metal composite	
	C5.2 Composite (stack), non-metal - metal composite	
	C5.3 Composite (stack), non-metal - non-metallic composite	
	C5.4 Composite (stack), non-ferrous metal - non-ferrous metal composite	
	C5.5 Composite (stack), non-ferrous metal - metal composite	
C5.6 Composite (stack), metal - metal composite		
S	S1.1 Titanium, titanium alloys	< 400
	S2.1 Titanium, titanium alloys	< 1,200
	S2.2 Titanium, titanium alloys	> 1,200
	S3.1 Nickel, non-alloy and alloy	< 900
	S3.2 Nickel, non-alloy and alloy	> 900
	S4.1 High-temperature super alloy Ni, Co and Fe-based	
S5.1 Tungsten and molybdenum alloys		
H	H1.1 Hardened steel/cast steel	< 44
	H1.2 Hardened steel/cast steel	< 55
	H2.1 Hardened steel/cast steel	< 60
	H2.2 Hardened steel/cast steel	< 65
H3.1 Wear-resistant cast/chill casting, GJN	< 68	

* MAPAL machining groups

** If the alloy parts Cr, Mo, Ni, V, W in total > 8 %, then select the next highest MAPAL machining group.

	ø < 5 [mm]		ø < 5-8 [mm]		ø < 8-12 [mm]		ø < 12-16 [mm]		ø < 16-20 [mm]		ø < 20-25 [mm]		ø < 25-31 [mm]	
	v _c [m/min]	f [mm]	v _c [m/min]	f [mm]	v _c [m/min]	f [mm]	v _c [m/min]	f [mm]	v _c [m/min]	f [mm]	v _c [m/min]	f [mm]	v _c [m/min]	f [mm]
	60	0.06	60	0.08	60	0.10	60	0.12	60	0.14	60	0.18	60	0.22
	50	0.04	50	0.06	50	0.08	50	0.10	50	0.12	50	0.14	50	0.18
	50	0.04	50	0.06	50	0.08	50	0.10	50	0.12	50	0.14	50	0.18
	40	0.03	40	0.04	40	0.05	40	0.06	40	0.08	40	0.10	40	0.12
	50	0.04	50	0.06	50	0.08	50	0.10	50	0.12	50	0.14	50	0.18
	40	0.03	40	0.04	40	0.05	40	0.06	40	0.08	40	0.10	40	0.12
	30	0.04	30	0.05	30	0.06	30	0.07	30	0.08	30	0.09	30	0.12
	50	0.04	50	0.06	50	0.08	50	0.10	50	0.12	50	0.14	50	0.18
	30	0.04	30	0.05	30	0.06	30	0.07	30	0.08	30	0.09	30	0.12
	30	0.04	30	0.05	30	0.06	30	0.07	30	0.08	30	0.09	30	0.12
	25	0.04	25	0.05	25	0.06	25	0.07	25	0.08	25	0.09	25	0.12
	30	0.04	30	0.05	30	0.06	30	0.07	30	0.08	30	0.09	30	0.12
	25	0.04	25	0.05	25	0.06	25	0.07	25	0.08	25	0.09	25	0.12
	50	0.06	50	0.10	50	0.12	50	0.14	50	0.18	50	0.20	50	0.25
	45	0.06	45	0.10	45	0.12	45	0.14	45	0.18	45	0.20	45	0.25
	45	0.06	45	0.10	45	0.12	45	0.14	45	0.18	45	0.20	45	0.25
	45	0.06	45	0.10	45	0.12	45	0.14	45	0.18	45	0.20	45	0.25
	35	0.06	35	0.10	35	0.12	35	0.14	35	0.18	35	0.20	35	0.25
	35	0.06	35	0.10	35	0.12	35	0.14	35	0.18	35	0.20	35	0.25
	80	0.08	80	0.10	80	0.12	80	0.14	80	0.18	80	0.22	80	0.26
	80	0.08	80	0.10	80	0.12	80	0.14	80	0.18	80	0.22	80	0.26
	60	0.08	60	0.10	60	0.12	60	0.14	60	0.18	60	0.22	60	0.26
	60	0.08	60	0.10	60	0.12	60	0.14	60	0.18	60	0.22	60	0.26
	70	0.10	70	0.12	70	0.14	70	0.18	70	0.20	70	0.24	70	0.30
	70	0.10	70	0.12	70	0.14	70	0.18	70	0.20	70	0.24	70	0.30
	70	0.10	70	0.12	70	0.14	70	0.18	70	0.20	70	0.24	70	0.30
	25	0.06	25	0.10	25	0.12	25	0.14	25	0.18	25	0.20	25	0.25
	25	0.06	25	0.10	25	0.12	25	0.14	25	0.18	25	0.20	25	0.25
	70	0.10	70	0.12	70	0.14	70	0.18	70	0.20	70	0.24	70	0.30
	70	0.10	70	0.12	70	0.14	70	0.18	70	0.20	70	0.24	70	0.30
	70	0.10	70	0.12	70	0.14	70	0.18	70	0.20	70	0.24	70	0.30
	25	0.06	25	0.10	25	0.12	25	0.14	25	0.18	25	0.20	25	0.25
	25	0.06	25	0.10	25	0.12	25	0.14	25	0.18	25	0.20	25	0.25
	25	0.06	25	0.10	25	0.12	25	0.14	25	0.18	25	0.20	25	0.25
	25	0.06	25	0.10	25	0.12	25	0.14	25	0.18	25	0.20	25	0.25
	25	0.06	25	0.10	25	0.12	25	0.14	25	0.18	25	0.20	25	0.25
	25	0.06	25	0.10	25	0.12	25	0.14	25	0.18	25	0.20	25	0.25
	25	0.06	25	0.10	25	0.12	25	0.14	25	0.18	25	0.20	25	0.25
	25	0.06	25	0.10	25	0.12	25	0.14	25	0.18	25	0.20	25	0.25
	25	0.06	25	0.10	25	0.12	25	0.14	25	0.18	25	0.20	25	0.25
	25	0.06	25	0.10	25	0.12	25	0.14	25	0.18	25	0.20	25	0.25
	25	0.06	25	0.10	25	0.12	25	0.14	25	0.18	25	0.20	25	0.25
	15	0.04	15	0.05	15	0.06	15	0.07	15	0.08	15	0.09	15	0.12
	15	0.04	15	0.05	15	0.06	15	0.07	15	0.08	15	0.09	15	0.12
	15	0.04	15	0.05	15	0.06	15	0.07	15	0.08	15	0.09	15	0.12
	15	0.04	15	0.05	15	0.06	15	0.07	15	0.08	15	0.09	15	0.12
	15	0.04	15	0.05	15	0.06	15	0.07	15	0.08	15	0.09	15	0.12
	15	0.04	15	0.05	15	0.06	15	0.07	15	0.08	15	0.09	15	0.12
	15	0.04	15	0.05	15	0.06	15	0.07	15	0.08	15	0.09	15	0.12
	12	0.04	12	0.05	12	0.06	12	0.08	12	0.08	12	0.10		
	12	0.04	12	0.05	12	0.06	12	0.08	12	0.08	12	0.10		
	8	0.04	8	0.05	8	0.06	8	0.08	8	0.08	8	0.10		
	8	0.04	8	0.05	8	0.06	8	0.08	8	0.08	8	0.10		
	12	0.04	12	0.05	12	0.06	12	0.08	12	0.08	12	0.10		

The specified cutting values are guide values.

The optimum data for the respective machining task should be determined during the test or machining.

BORING AND TURNING

Cartridges offer maximum flexibility for individual tool solutions. The ModulBore range is a modular solution for boring and fine boring.

Positive radial indexable inserts for boring and turning. Tangential indexable inserts for the highest demands when boring.



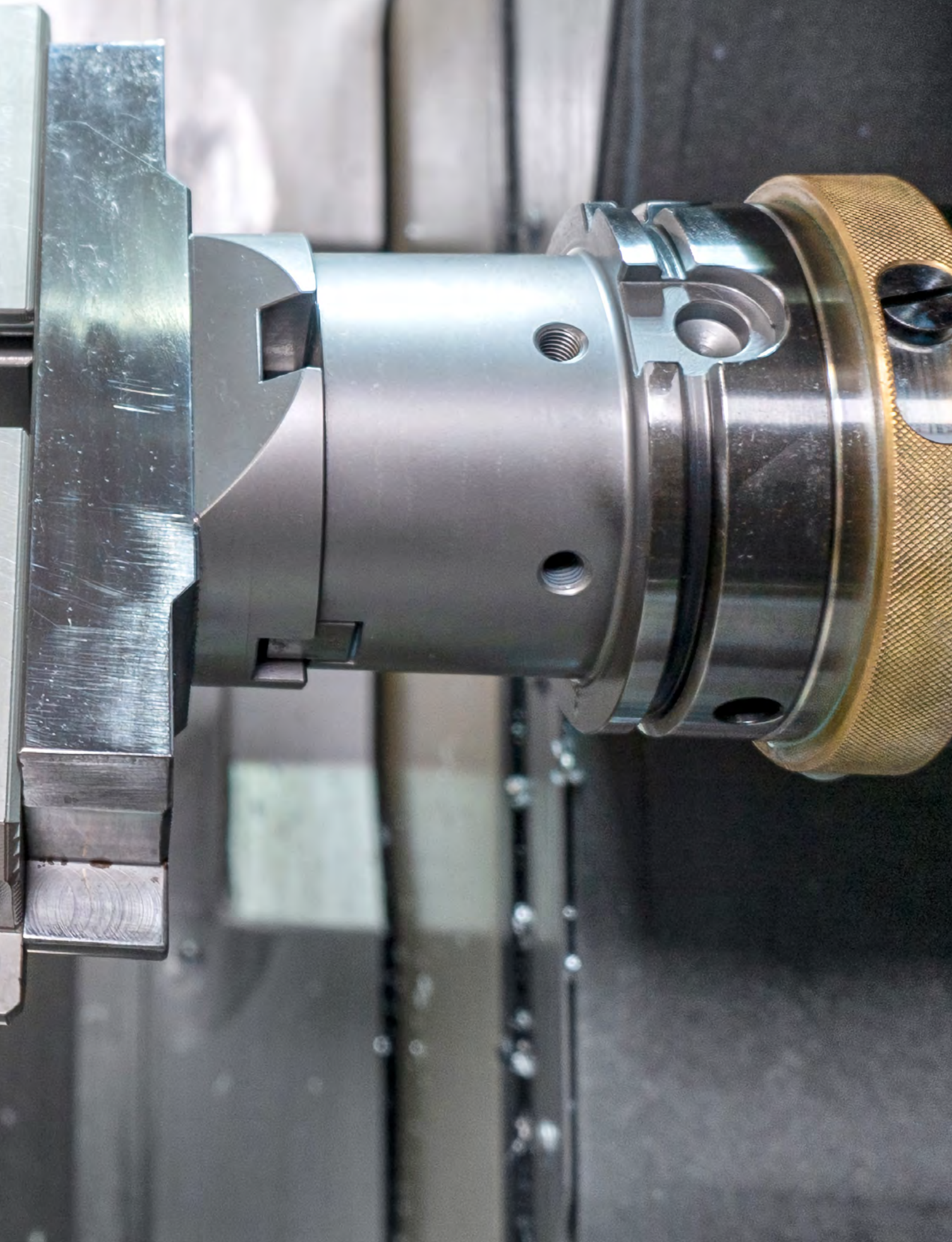

PRODUCT OVERVIEW

Boring and turning

MAPAL boring tools for the machining step between drilling from the solid and fine machining represent an optimal combination of cost-effectiveness and robustness tough enough for any machining forces that arise. Based on innovative technology and absolute precision, MAPAL offers a comprehensive range of custom tools with indexable inserts and fixed brazed PCD cutting edges. Mapal's understanding of the complete machining process and the production process as a whole makes real progress possible here.

With the standard range ModulBore, MAPAL offers a complete system for pre-machining and finishing bores in the diameter range from 6 to 1,000 mm. Easily adjustable cartridges offer numerous possibilities in various applica-

tions. The standard range is compatible with all common ISO indexable inserts and covers the bulk of installation variants in engineering.

The range of indexable inserts in special designs as well as radial and tangential indexable inserts covers all requirements for cutting materials and coatings as well as the corresponding blade geometries and accuracies. Select carbide and PCD-tipped indexable inserts are also available for turning applications.



Special solutions



Boring with PCD

- Individual tool solutions for demanding machining tasks
- Highest machining quality for dimensions, surface finish and shape
- Realisation of complex cutting geometries
- Twisted tools for machining delicate or unstable parts and clamping systems
- Manufacturing tolerances from $\leq 3 \mu\text{m}$ for tool diameter
- Multi-stage design guarantees coaxiality of stepped bores
- Boring tools as combination tool to reduce non-productive times
- Optimised for usage with minimum quantity lubrication (MQL)



Boring with indexable inserts

- Multi-stage design means less tools and machining time are needed
- Higher effectiveness due to the usage of tangential technology
- Guide pads ensure very high positioning accuracy
- Spring-loaded guide pads for reliable machining of large drilling depths
- Hybrid tools combine different tool systems
- In unstable machining situations or with large projection lengths, vibration dampers ensure higher machining quality and longer tool life

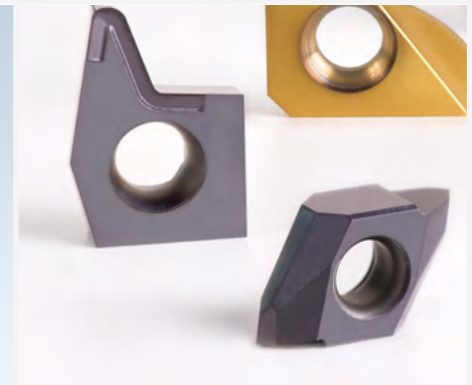

Indexable inserts in special design

- Realisation of complex geometries and contours for almost all applications
- Form cutting edges for machining complex contours with high shape accuracy
- Modern production facilities guarantee the highest precision and flexibility of special MAPAL inserts
- High-performance cutting materials for every work-piece material
- PCD- and PcBN-tipped indexable inserts are also available



Standard range



ModuBore

- Diameter range from 6 to 1,000 mm
- High flexibility due to modular construction
- Large diameter ranges can be machined using one tool
- Internal coolant supply for optimal chip removal
- Available with fine adjustment feature (ModuBore Plus)
- Face-side serration guarantees a stable, high-performance system
- Variant with ISO cartridges for machining larger diameter



Cartridges

- High flexibility due to quick, straightforward interchangeability
- Adjusting feature with long adjustment range
- Compatible with all common ISO indexable inserts
- Suitable for both external and internal machining operations
- Available in different installation variants
- Also available as compact cartridge with shorter length

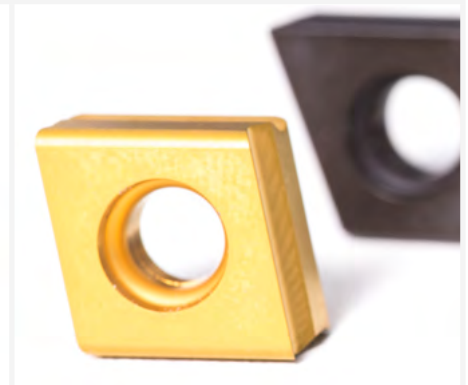

Indexable inserts

- Positive radial inserts for boring and turning
- Tangential indexable inserts for the highest demands
- Ground and pressed cutting edges available
- PVD- and CVD-coated cutting materials cover a wide spectrum from wear resistance to ductility
- Tipped variants with PCD and PcBN for highly cost-effective machining of aluminium or cast iron

SPECIAL SOLUTIONS

Boring with PCD

Custom solutions with PCD cutting edges are the first choice if it is necessary to machine large quantities of aluminium and die cast aluminium parts reliably and cost-effectively. By using modern CNC controllers and laser technology, today it is possible to manufacture just about any cutting geometry reliably – and that with manufacturing tolerances from $\leq 3 \mu\text{m}$ on the tool diameter.

The combination of several machining operations in one tool is particularly worthwhile. The savings in tools and reduction of non-productive times increases the cost-effectiveness in production.

A stepped bore where all chamfers and radii are machined can be created using a PCD boring tool with several steps. In this way the concentricity of the individual steps is guaranteed. The machining of axial recesses or spot facing of contact surfaces can also be solved cost-effectively using one drilling tool. Flatness requirements or angular accuracies can be achieved much more easily than with conventional turning or circular movements, as there are no radial forces acting on the workpiece.

MAPAL manufactures twisted PCD tools with decisive advantages compared to straight-fluted tools. The tools can be flexibly designed to the respective process, for example for minimum quantity lubrication. Hollow shank tape designs and modular systems that can be aligned ensure optimal results.

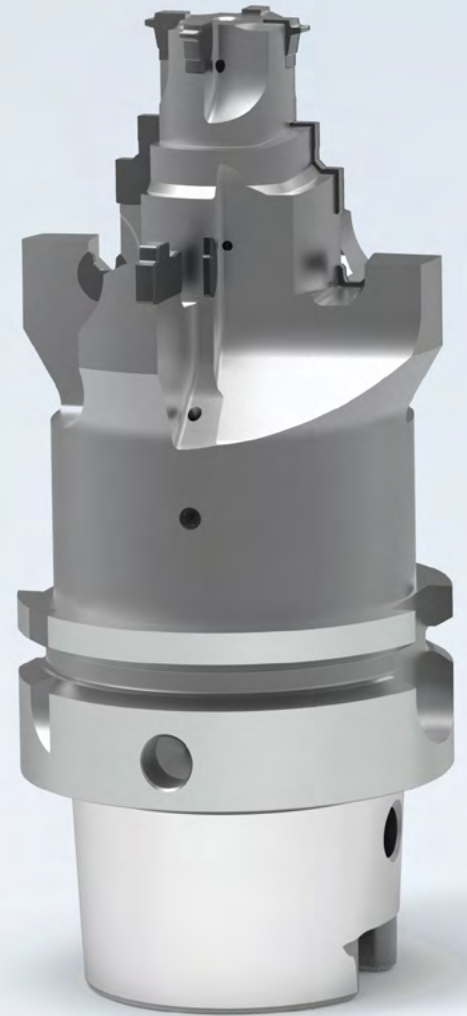

Special solutions



Polycrystalline diamond – PCD

- PCD is a cutting material for machining aluminium, non-ferrous metals, CFRP and other modern workpiece materials
- Synthetically produced from select diamond particles
- Sintered at approx. 1,500 °C and approx. 60 kbar pressure
- Extremely hard and wear-resistant structure
- Various basic substrates allow the selection of the right cutting material for the respective application



PCD Centre of Competence

- MAPAL Centre of Competence for PCD tools in Pforzheim
- World's largest development and production facility for PCD tools
- High quality standard in conjunction with highly qualified staff guarantee first-class production results
- Use of modern production technologies
- Use of laser technology

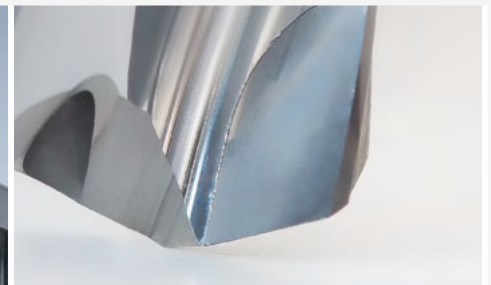

Maximum precision

- μm -precisely ground PCD cutting edges for highest precision
- Manufacturing tolerances from $\leq 3 \mu\text{m}$ for tool diameter
- Highest machining quality for dimensions, surface finish and shape
- Laser-machined chip guiding stages, chip breakers and chip formers make optimal chip removal possible and prevent chip congestion
- Modular design for highest radial run-out accuracy
- Precise and safe adjustment of radial run-out through axial and radial adjustment options

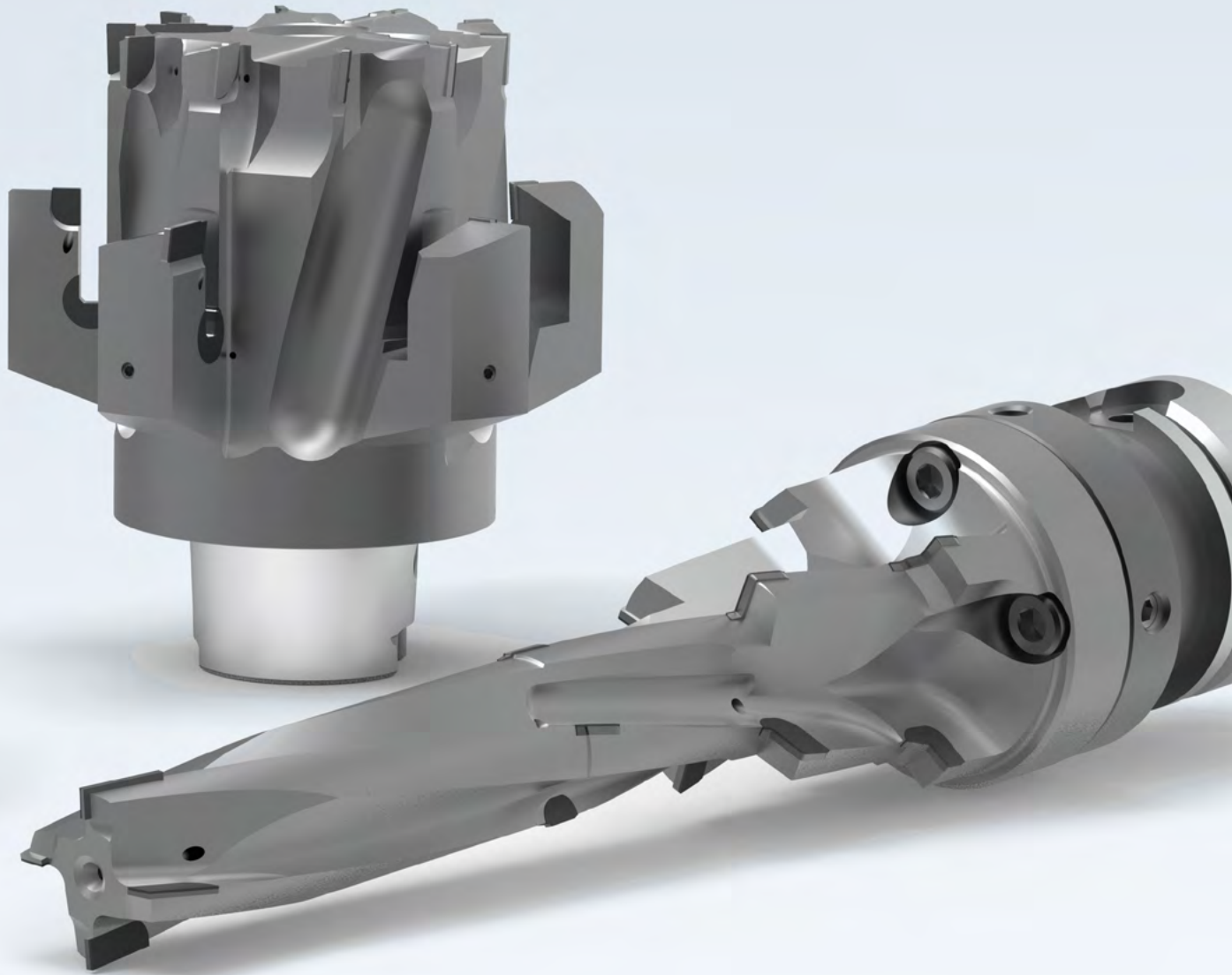

Complex geometries

- Laser machining enables precise production of highly complex cutting edge geometries as well as the realisation of extreme rake and spiral angles
- Advantages of spiralised PCD reaming tools compared to straight fluted counterparts:
 - Good leadership behaviour and very high processing qualities
 - Highly positive rake angles reduce necessary cutting forces
 - Ideal for machining filigree or unstable components and fixtures
 - Better chip removal due to the groove design

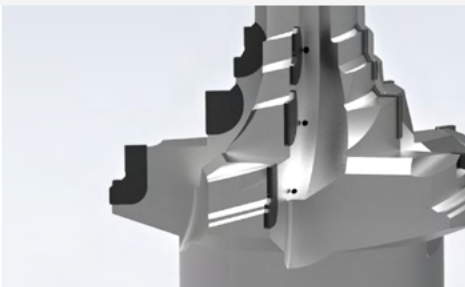

Innovative solutions

- Development of reliable solutions based on the most efficient machining strategies, such as minimum quantity lubrication (MQL)
- Combination tools reduce the number of process steps and shorten non-productive times
- PCD boring tools with several steps guarantee the concentricity of stepped bores
- Precisely embedded PCD segments
- Precisely matched to the respective step geometry



Reconditioning

- Reconditioning significantly extends the service life of PCD boring tools
- This saves costs for new tools
- Tools ready for immediate use
- Customary tool lives are reached without any problems
- Picked up from and delivered to you directly by parcel service
- Standardised process for uncomplicated and fast processing within a few days

SPECIAL SOLUTIONS

Boring with PCD (1/2)

Application examples for special solutions with PCD

- 1 Boring tool with brazed PCD indexable inserts and exchangeable standard indexable inserts with adjustment option for the implementation of bores with IT6 and defined roughness
- 2 Step drilling tool with adjustable and interchangeable reverse machining for machining a differential housing produced of aluminium
- 3 Combination boring tool for machining an oil pump with an exchangeable solid carbide insertion tool
- 4 Multi-stage boring tool for machining a steering housing/steering rack tube produced of AISi9Cu3. Thanks to the titanium body, the tool weighs only 5.5 kg despite its extreme dimensions
- 5 Boring tool with a lightweight design for machining a compressor baseplate produced of AISi9Cu3. Due to the low tool weight, very high cutting data are possible and the load on the spindle is reduced
- 6 Twisted step boring tool for machining a steering housing produced of AISi9Cu3 with a module interface that can be aligned. Due to the twisted design, very soft cut and mechanical chip discharge
- 7 Step boring tool for machining a bearing bore with an integrated fine adjustment feature for the pilot on a camshaft bore in a cylinder head cover produced of AISi-9Cu3Fe for a process with minimum quantity lubrication

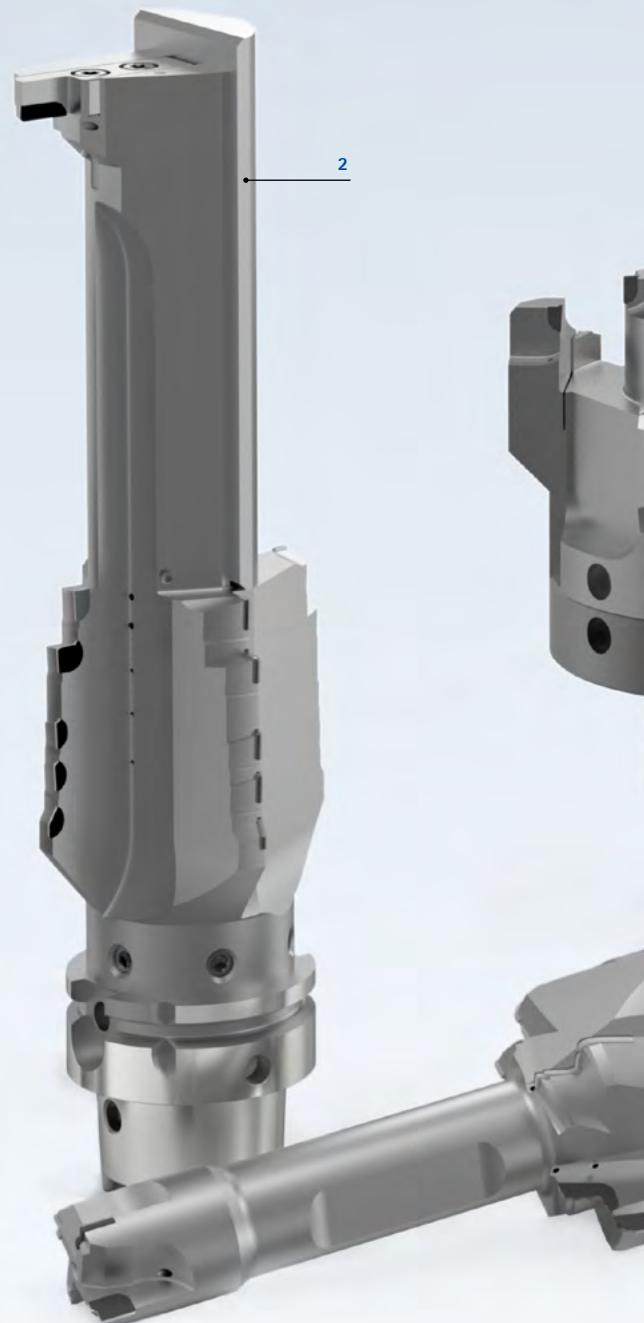
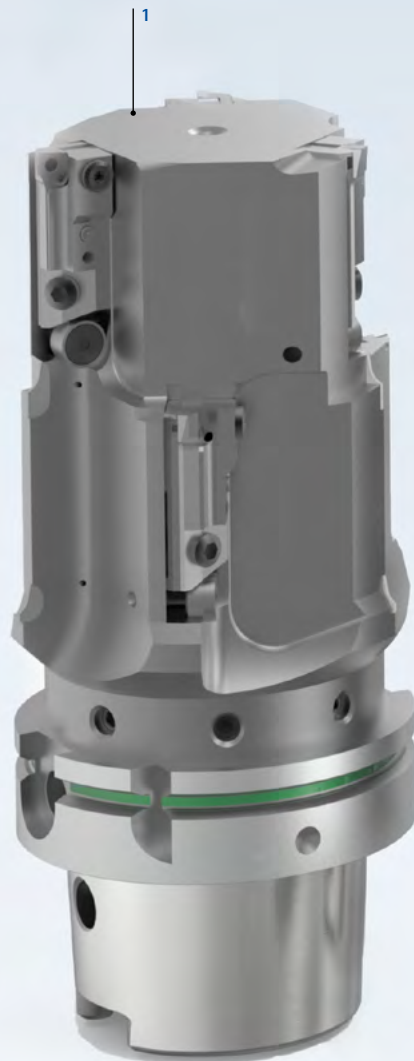

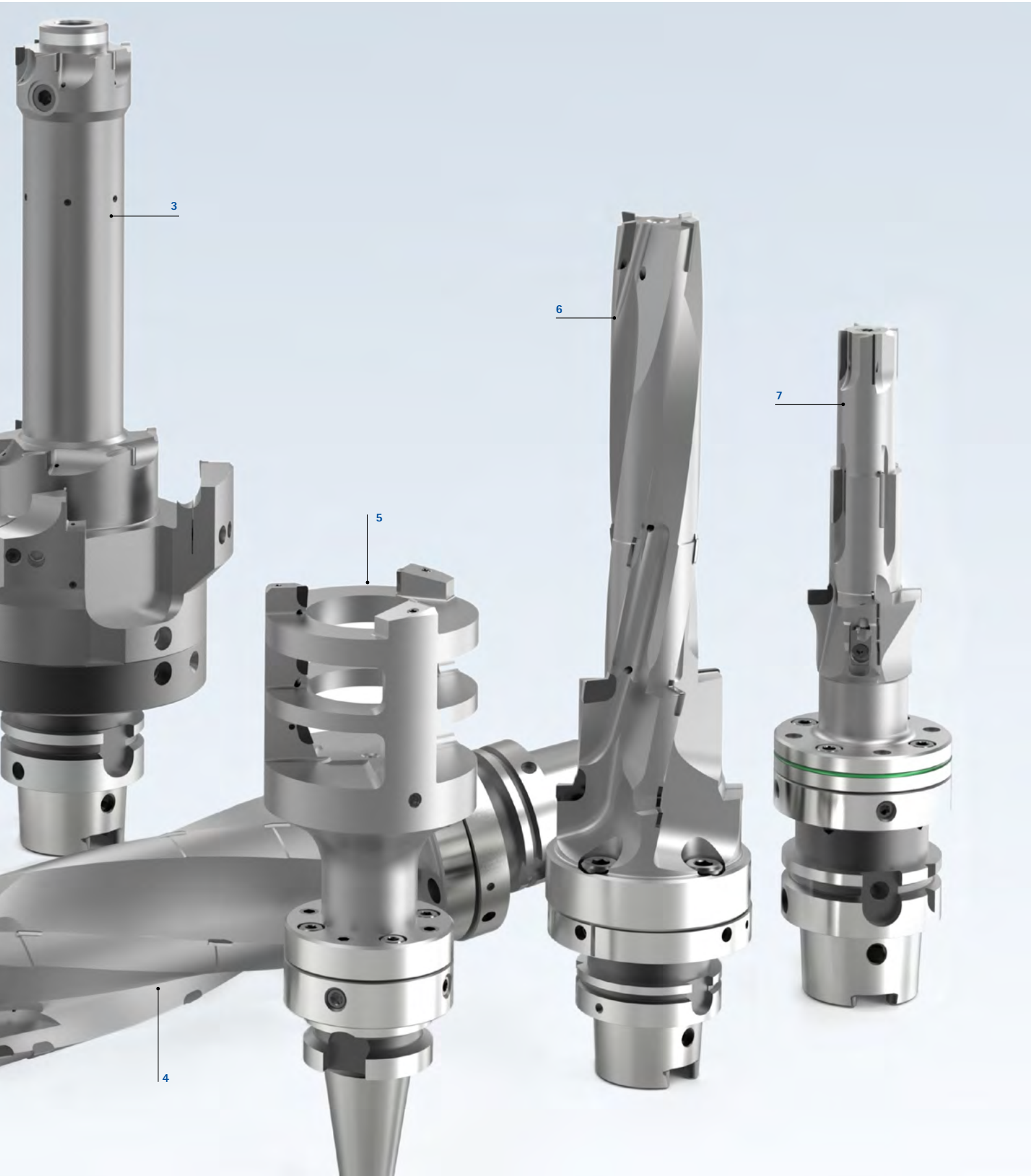

SPECIAL SOLUTIONS

Boring with PCD (2/2)

Application examples for special solutions with PCD

- 1 Bore milling tool for machining a steering knuckle produced of aluminium. Embedded cutting edges ensure chatter-free surfaces while maintaining all tolerances in both drilling and milling operations
- 2 Bell tool with brazed PCD cutting edges in a lightweight design for external machining of hose connections. The honeycomb structure inside the tool significantly reduces the weight, which makes higher cutting data possible. In addition, the honeycomb structure has a damping effect that has a positive impact on the tool life
- 3 Combination drilling-milling tool with PCD cutting edge and indexable inserts made of carbide for machining a rear frame produced of AISiMg0.3. The most heavily stressed cutting edges are designed to be replaceable
- 4 Twisted, triple-fluted, stepped solid drilling tool for machining the bolt bore of an aluminium rim
- 5 "One-shot" tool solution with integrated vibration damper for machining a steering feedback actuator
- 6 Circular milling cutter with 1+1+1 cutting edges for machining a thermostat housing produced of AL380
- 7 Multi-stage PCD boring tool for "one-shot machining" of an electric motor housing produced of AISi9Cu3Fe with a hollow design for use on very stable and powerful machine tools
- 8 Step boring tool for internal and external machining on a transmission housing made of AISi9Cu3Mg

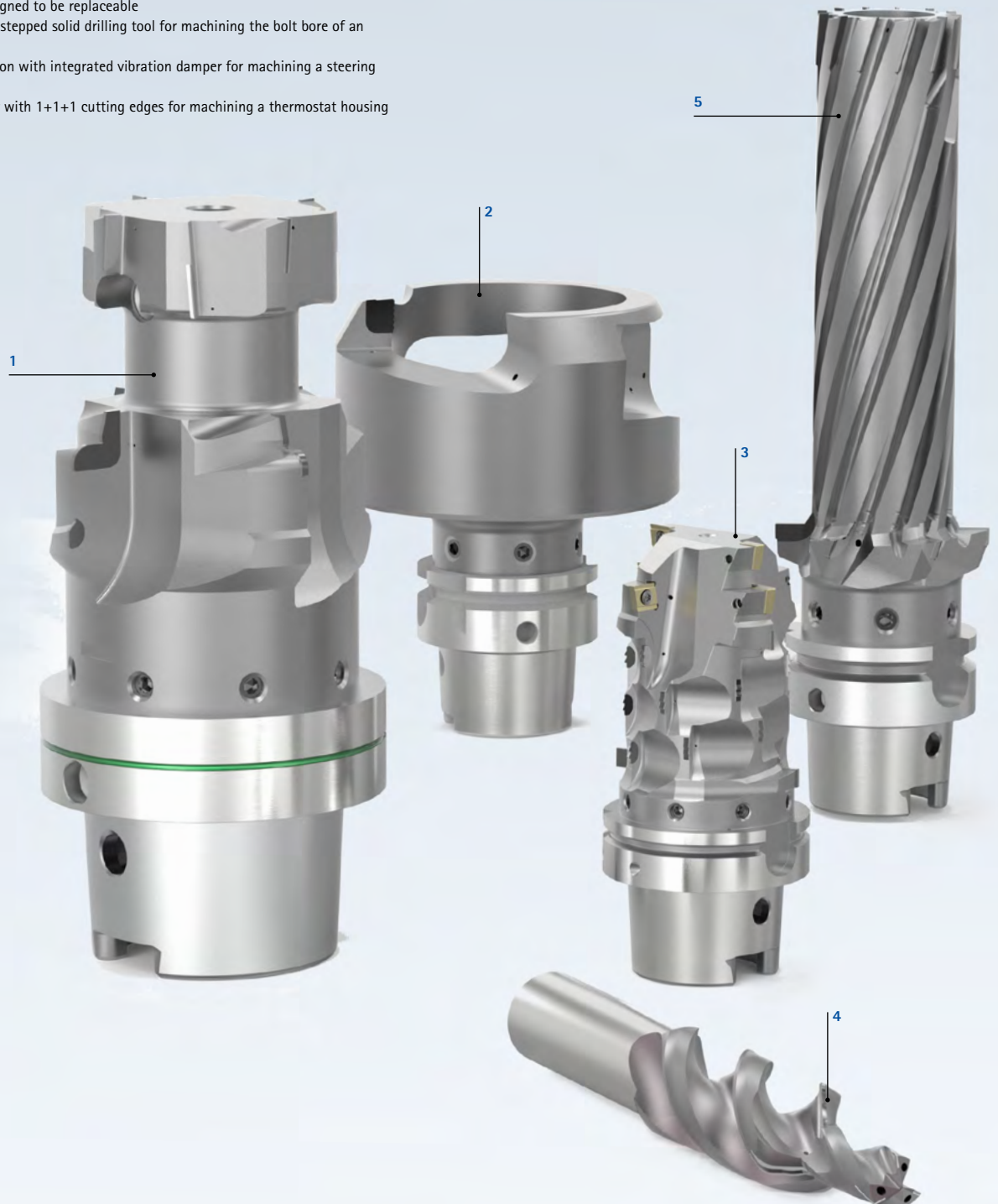

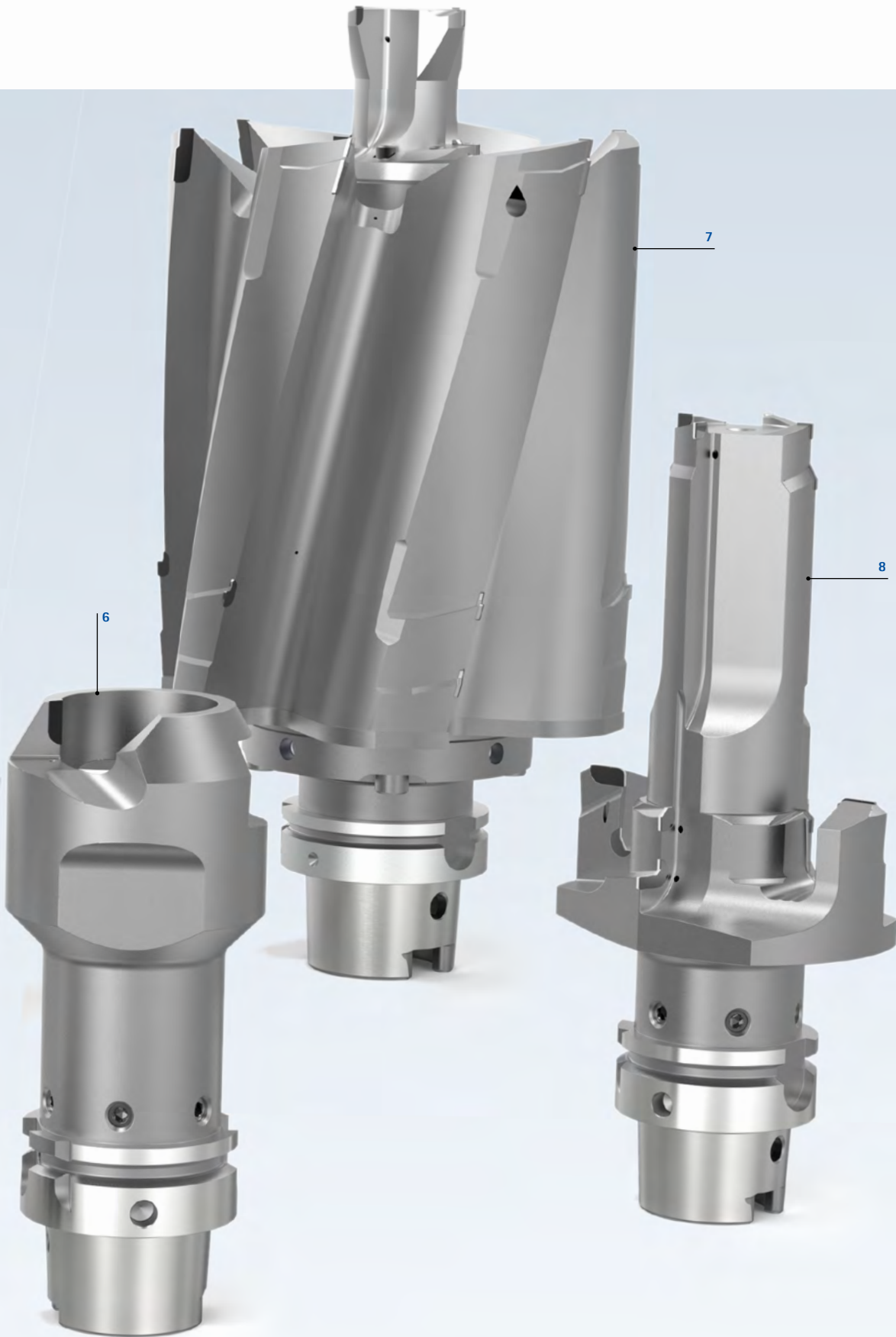

SPECIAL SOLUTIONS

Boring with indexable inserts

During the planning of new machining processes as well as the optimisation of existing processes, the focus is on the assessment of the machining time and the Cost Per Part (CPP). By means of intelligent, multi-stage, multi-cutting-edge combination tools or complete machining tools with indexable inserts, both the productive times and the non-productive times can be significantly reduced. To prepare a solution that is optimal for the customer, different machining systems are combined into so-called hybrid tools.

Tools with indexable inserts from MAPAL meet both the requirement for process reliability and straightforward handling – with intelligent and precise adapter solutions along with secure and quick indexable insert mounting.

The tools with indexable inserts function reliably thanks to the latest engineering methods that make it possible to assess collisions or to determine tool restrictions even during the planning phase. Production in the latest manufacturing facilities guarantees maximum tool precision.

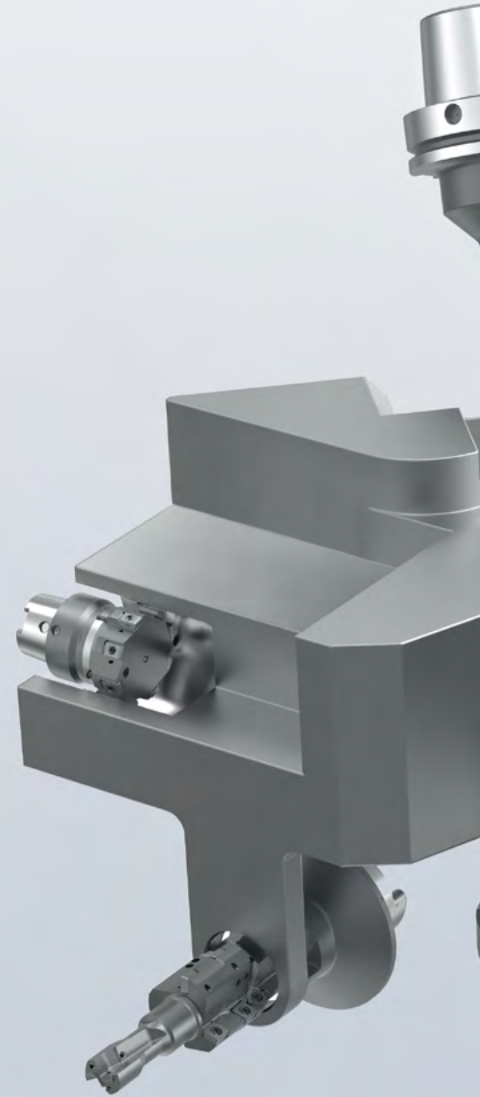

Special solutions

Process solutions

- Effective complete machining tools simultaneously shorten productive and non-productive times
- Optimised processes reduce machining time by up to 60 per cent
- Reduced cycle times
- Less energy consumption
- More cost-effective

Design and production

- Development and design of complex tangential tools through state-of-the-art 3D design and computer-aided analysis
- Precisely defined insert seats and chip spaces
- Manufacturing with high-precision, high-performance 5-axis machining centres
- Monitoring and control by experienced staff
- Compliance with highly accurate manufacturing tolerances
- Real multi-cutting-edge capability and the high performance of the tools

Modular construction

- Modular design of combination tools with indexable inserts
- Machining of entire component families with just a few tools
- In case of wear and tear, only the part of the tool that is worn out needs to be replaced
- By using connections, for instance a highly accurate HSK-C (hollow shank taper) connection, particularly complex tools can be constructed
- Several machining steps combined into one tool
- Increase in productivity

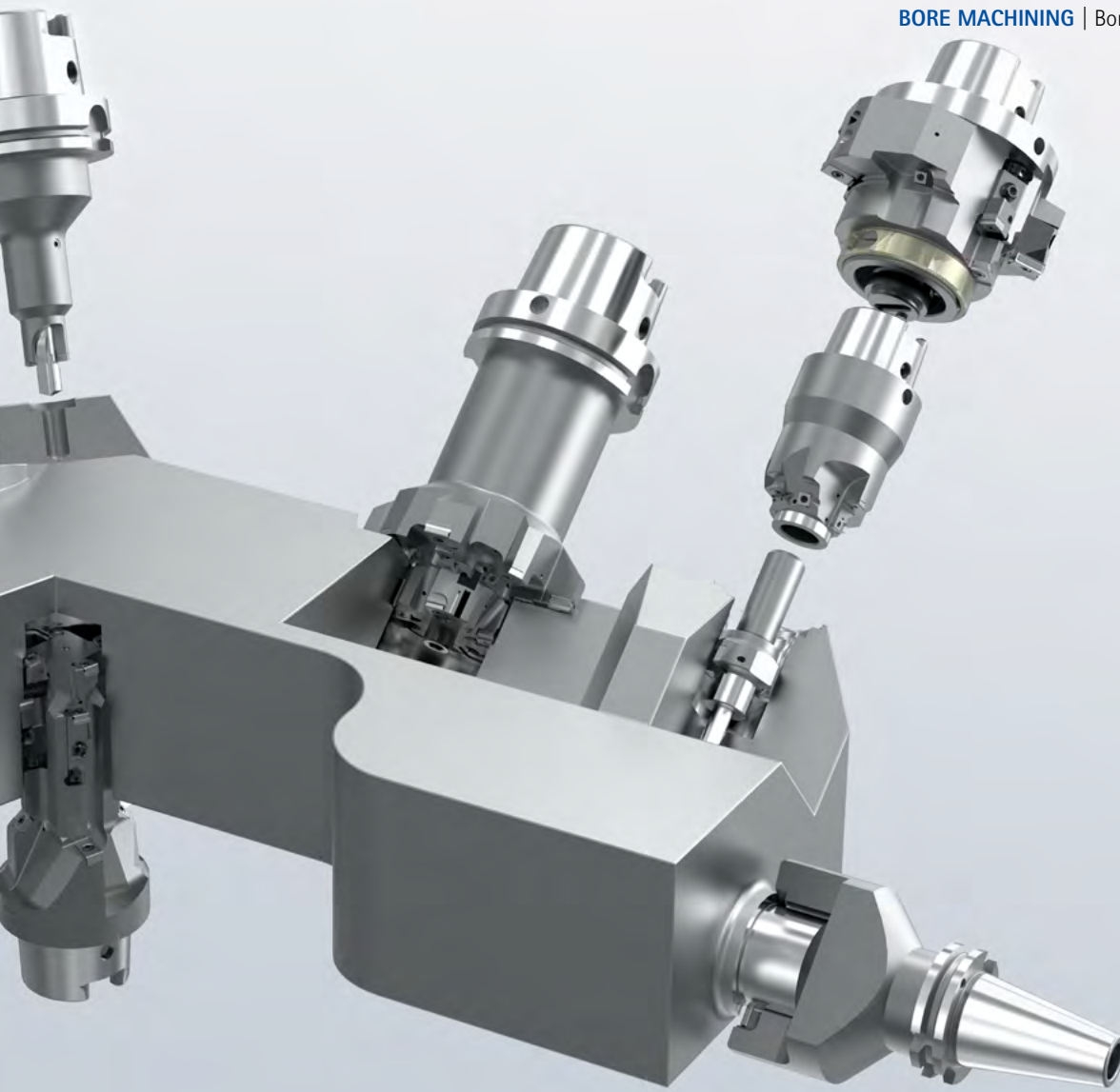

Tangential technology

- Tangential technology for high performance of boring tools with indexable inserts
- Compared to the use of radially mounted indexable inserts, more cutting edges can be used with the same power consumption
- Higher machining values and machining volume
- Very quiet running
- Excellent tool life and very good component qualities

Cutting edges

- Wide selection of geometries and cutting materials
- The right cutting edge for every application
- Different forms and sizes
- All cutting materials such as carbide, ceramic and indexable inserts with PCD or PcBN available
- High cost-effectiveness and resource reliability
- Optimal use of the cutting material due to up to eight cutting edges

Exact adjustment

- Specially developed adjustment system for highly precise adjustability of the cutting edges
- Stable support as the adjusting wedge is completely embedded in the tool body
- Cutting edge rests extensively on adjusting wedge
- The adjusting wedge has an angled surface and can be moved using a left-hand/right-hand setscrew
- Left-hand/right-hand setscrew provides indirect, very precise and easy-to-use adjustment

SPECIAL SOLUTIONS

Boring with indexable inserts (1/2)

Application examples for special solutions with indexable inserts

- 1 Machining the rotor bore in a compressor housing produced of GJL with vibration damper on the face side
- 2 Tool with guide pad technology for optimal support on machining a spindle on a rotary table machine with a length of over 1,000 mm
- 3 Combination tool with solid carbide insertion drill for brake bracket mounting and for multi-step machining of a hub carrier produced of GJS
- 4 Tangential construction makes possible the complete countersinking of the shaped contour on a rotor bore in a turbocharger produced of highly heat-resistant materials using minimum quantity lubrication
- 5 Special tool for steering knuckle manufacture for roughing and semi-machining, incl. edge breaking and recess milling and additional insertion drill
- 6 Ultra lightweight combination tool with tool body parts produced of CFRP, radial and tangential indexable inserts for machining the main train in a gearbox housing produced of aluminium
- 7 Combination tool for the multi-stage machining a heavy-duty gearbox produced of GJL



Vibration dampers enable significantly better surface finishes during machining. The design is individually adapted to the respective machining tasks.

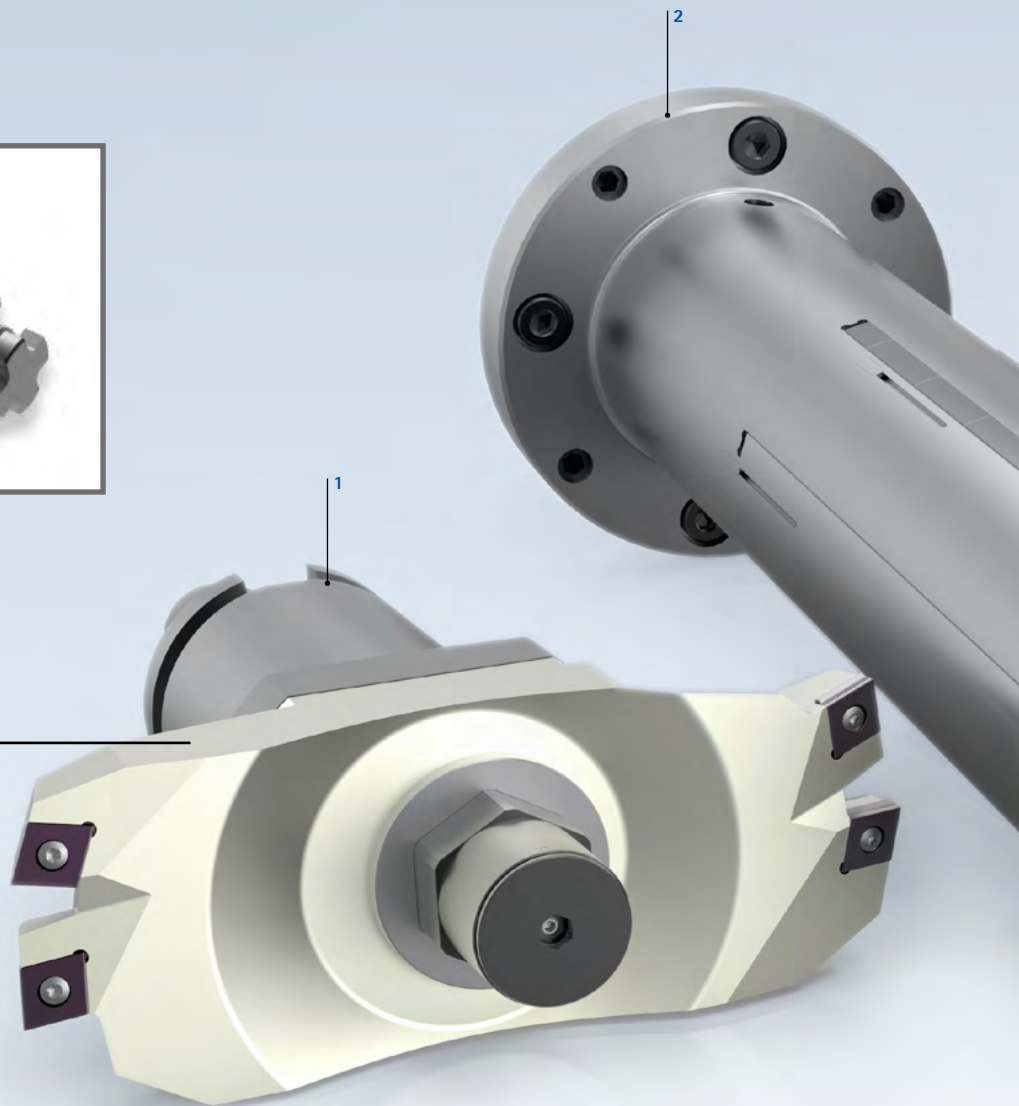



SPECIAL SOLUTIONS

Boring with indexable inserts (2/2)

Application examples for special solutions with indexable inserts

- 1 Interpolation turning tool with mould plates and a continuous cut path for machining the recess contour V-band connection of a turbine housing (turbocharger).
- 2 Pre-finishing and semi-finishing of the main bore of the turbine housing (turbocharger). Six machining features and a control cut are made using only one tool.
- 3 Combination tool with tangential indexable inserts and guide pads produced of cermet and PCD.
- 4 Fine machining of turbine and compressor housings with the TOOLTRONIC® mechatronic actuating tool.
- 5 Machining of the main bore with an ISO combination tool that combines the machining steps recessing, fine boring and countersinking.





SPECIAL SOLUTIONS

Indexable inserts in special design

Form cutting edges are often used to efficiently machine complex contours with high shape accuracy.

MAPAL provides numerous options in relation to form, cutting material and coating for these inserts. Modern production facilities guarantee the highest precision and flexibility of MAPAL indexable inserts in special design.

PCD- and PcBN-tipped indexable inserts are also available in this range. Fitted in the high-precision insert seats of MAPAL tools, they achieve the best results in terms of both economy and quality.



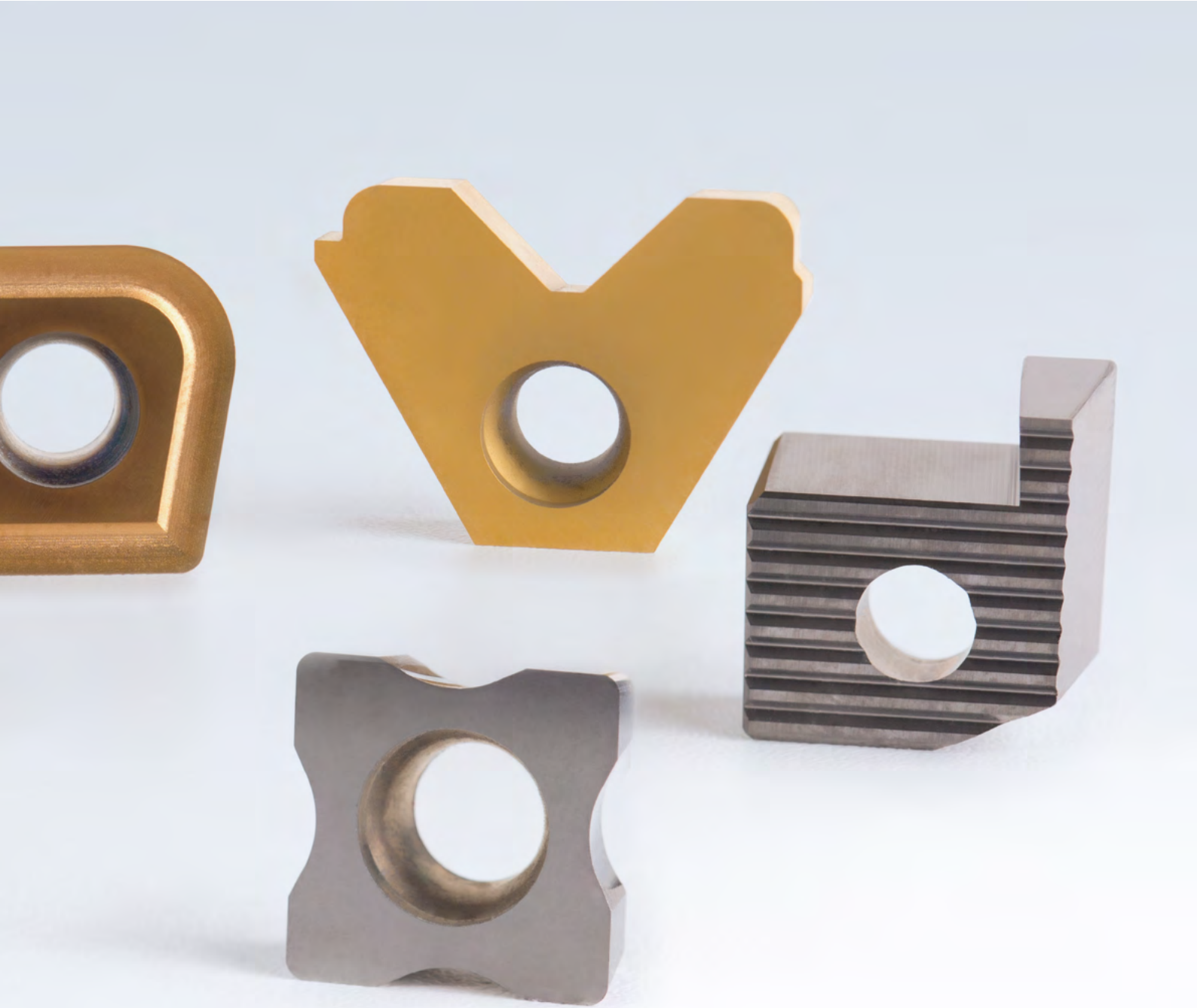

ADVANTAGES

- High process reliability in case of contour-dependent shapes and geometries
- Less complex machining sequences
- Multi-cutting-edge capability when creating complex contours





ModuBore

High flexibility during boring and fine boring

With the ModuBore boring range, MAPAL offers a complete system for pre-machining and finishing bores in the diameter range from 6 to 1,000 mm.

Thanks to its modular structure, the system is very flexible and can be configured for the specific machining task. Double edged boring tools are available for roughing. Thanks to a frontal serration on which the cutting edge holders are mounted, the tools are very stable and effective. The usage of indexable inserts with positive basic geometry, helical chip spaces and internal coolant supply ensures a broad range of applications, a high level of work safety and straightforward handling.

The ModuBore fine boring heads are available from a diameter of 6 mm. They are characterised by their high precision and robust construction, are very easy to handle and also have an internal coolant supply. The fine adjustment of the heads in either direction is very accurate and does not exhibit the "stick-slip effect".

The ModuBore range is individually adapted to customer-specific requirements and is therefore not available from stock.

ModuBore

Introduction	614
System overview	618
ModuBore – boring	620
ModuBore – fine boring	627
Adapters	636

ModulBore – boring

Ø 22 – 115 mm

Twin cutting edge tool with the ModulBore System (MBS) in seven dimensions for indexable insert holders (indexable insert cassettes).

Ø 87 – 202 mm

Boring heads as bridge construction. Distributed over five bridges for indexable insert holders (indexable insert cassettes).

Ø 200 – 520 mm

Boring heads as bridge construction. Distributed over four bridges for equipping with slides for commercially available ISO cartridges.

Ø 358 – 1,000 mm

Boring heads as bridge construction (large boring range). Distributed over eight bridges for equipping with slides for commercially available ISO cartridges.



* Required order quantity: 2 pieces

Boring tools



Twin cutting edge tool with MBS

For roughing in the diameter range from 22 to 115 mm, double edged boring tools are available. Due to a serration on the face side on which the indexable insert holders are mounted, the system is very stable and effective. The usage of indexable inserts with positive basic geometry, helical chip flutes and internal coolant supply ensures a broad range of applications, a high level of work safety and straightforward handling.

The twin cutting edge tools are available both as a modular tool, and as monoblock tool with a hollow shank taper or steep taper connection.

* Required order quantity: 2 pieces



Boring heads with bridge module and ISO cartridges

Boring heads with a bridge module are available in the range from 87 to 1,000 mm. From a diameter of 200 mm, the bridge modules are equipped with ISO cartridges that are mounted on slides with serration on the face side on the bridges. For weight optimisation, the bridge modules are produced of aluminium in the diameter range from 358 to 1,000 mm.

ModulBore – fine boring

Ø 10 – 28 mm

Fine boring heads with boring bar

Ø 14 – 23 mm

Fine boring head

Ø 21 – 115 mm

Fine boring head with MBS

Ø 87 – 202 mm

Fine boring heads as bridge construction. Distributed over four bridges for equipping with slides for ModulBore fine boring cartridges.

Ø 200 – 520 mm

Fine boring heads as bridge construction. Distributed over four bridges for equipping with slides for ModulBore fine boring cartridges.

Ø 358 – 1,000 mm

Fine boring heads as bridge construction (large boring range). Distributed over eight bridges for equipping with slides for ModulBore fine boring cartridge.



Fine boring tools



Fine boring head with boring bar

The ModulBore fine boring heads are available from a diameter of 6 mm. They feature high precision and robust construction, are straightforward to handle, and also have an internal coolant supply. The fine adjustment of the heads in either direction is very accurate without "stick-slip effect".

The fine boring heads are available both as a modular tool, and as monoblock tool with a hollow shank taper or steep taper connection.



Fine boring heads with bridge module and fine boring cartridge

From a diameter of 87 mm the fine boring heads are designed with a bridge module. The bridge modules have slides that are fitted with adjustable fine boring cartridges. For larger diameters, the bridge tools are designed with one cutting edge. The opposite slide is used to compensate for the imbalance. For weight optimisation, the bridge modules are produced of aluminium in the diameter range from 358 to 1,000 mm.

ModulBore Plus – fine boring

The ModulBore Plus tools with fine adjustment feature a simple, precise adjusting mechanism. This enables defined, error-free feed directly on the machine using a standard Torx wrench. The high accuracy and simple handling reduce the non-productive time during fine boring while increasing quality and productivity.

MODULBORE PLUS

- **Fine adjustment feature:**
2 μm per graduation mark referring to the diameter
- **Reversing error:**
< 2 μm

ADVANTAGES

- Error-free reading (vernier not required)
- No "stick-slip effect"
- Low maintenance
- Easy to install
- Durable and robust: Three-year guarantee

Fine boring bar

The ModulBore Plus fine boring bar is suitable for usage in series and mass production and at the same time provides maximum tool lives.

Fine boring head

The reliable ModulBore Plus fine boring head is suitable for fine boring from prototype to mass production. The additional coarse adjusting unit gives the drill head a variable action radius of up to 9 mm. The complete range permits bore machining operations for diameters from 21 to 115 mm.

Fine boring cartridges

The ModulBore Plus fine boring cartridges are suitable for usage in single- or multiple-cutting-edge custom tools or in fine boring bridges for the large boring range. They do not require adjustment to the machine spindle.

ModulBore Plus tool systems

Fine boring bar \varnothing 14 to 23 mm



Fine boring head \varnothing 21 to 115 mm



Fine boring cartridges



ModulBore – adapters

MBS connection

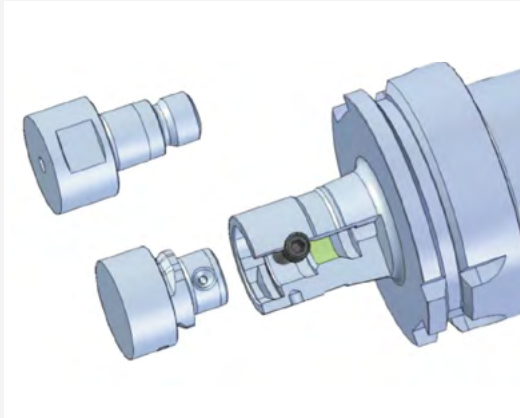

The MBS connection is the central feature of the ModulBore system. High torques are transmitted by the bayonet coupling, which forms a cylinder-face connection. Two radial clamping screws make it possible to preload the coupling and rotate the tool in both directions.

ADVANTAGES

- Simple handling, straightforward assembly and disassembly
- Highly precise bayonet coupling and cutting edge orientation
- High radial run-out accuracy due to face connection
- Internal coolant supply via the connection to the cutting edge
- Compatible with Starflex RFX

MBS adapter



The MBS adapters offer the possibility of adapting from the connection on the machine to the MBS connection. In this way, the comprehensive ModulBore range can be utilised without limitation. Common connections such as hollow shank taper (HSK) and various taper shanks (SK/BT) are included in the standard range in a wide range of nominal sizes and lengths. MBS extensions and reducers further increase the flexibility of the system. Other adapters can be manufactured as custom tools.

Milling arbors



The combined arbor/cross slot arbors are the basis for a large number of variations of the ModulBore bridge tools. The standard range covers the common connections such as hollow shank taper (HSK), various taper shanks (SK/BT) and MBS in a wide range of nominal sizes and lengths. In addition, other machine connections such as KM in accordance with DIN ISO 26622 as a combined milling cutter arbor can be equipped with the bridge tools.

ModulBore – system overview

ModulBore | Adapters

MBS adapter
Page 636 - 638

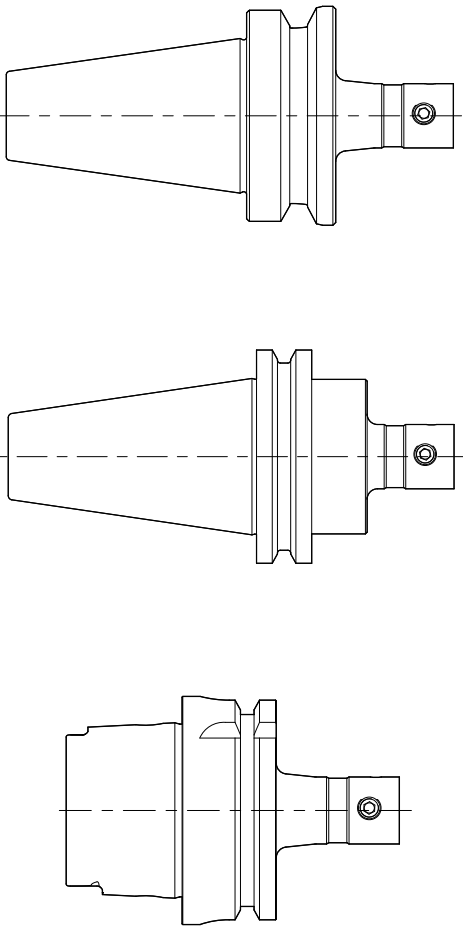

MBS extensions
Page 639

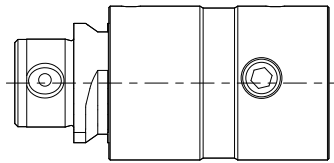

MBS reducers
Page 640

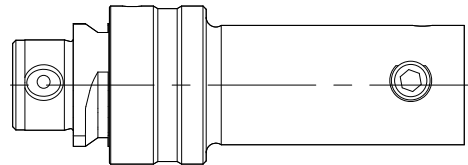

MBS cross slot arbors
Page 641

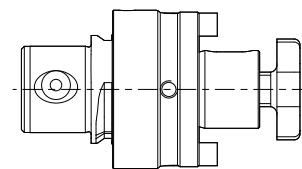

Milling arbors
see CLAMPING catalogue

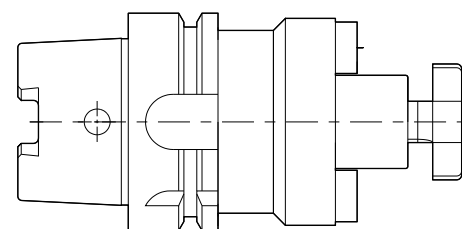

➤ MBS connection

➤ Arbor

ModulBore | Boring

Double cutter with MBS

Page 620

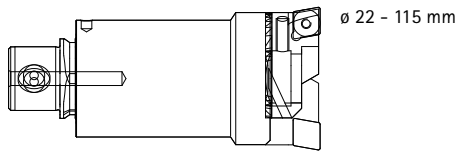

Also available as a monoblock tool!

Drilling head with bridge module

Page 622

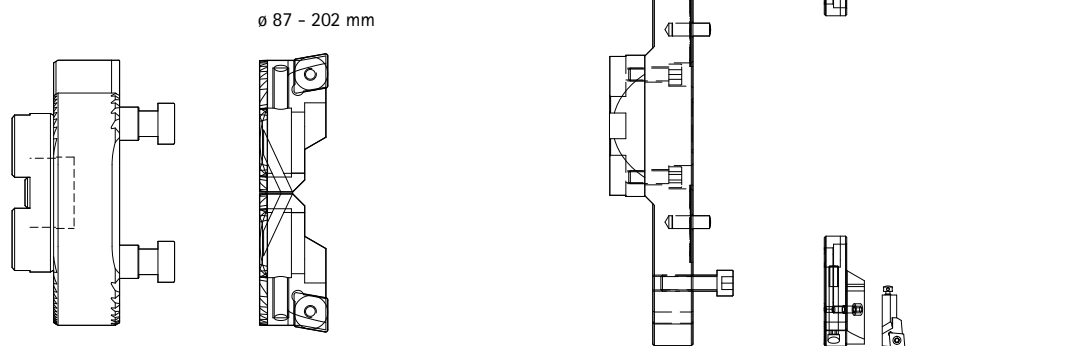

ModulBore | Fine boring

ModulBore-Fine boring head with MBS

Page 627

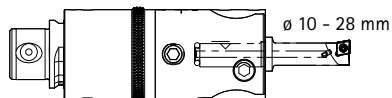

Also available as monoblock tool with HSK/SK interface available!

ModulBore-Plus Fine boring head with MBS

Page 630

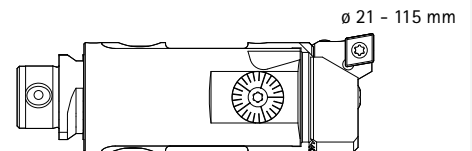

ModulBore-Fine boring head with bridge module

Page 631

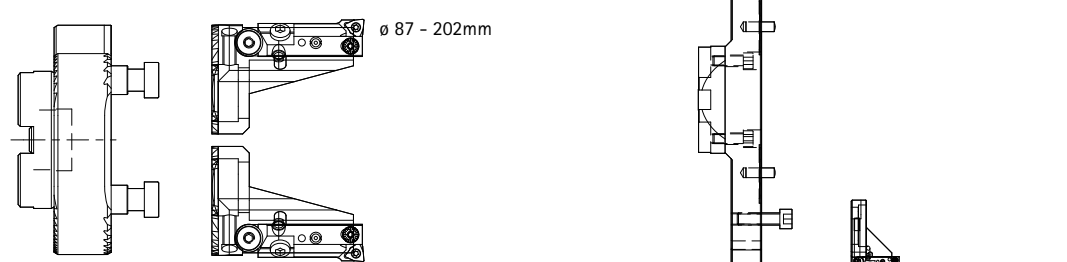

ModulBore – twin cutting edge tools with MBS

Boring tool for roughing, tool body without indexable insert cassettes

Ø 22 – 115 mm

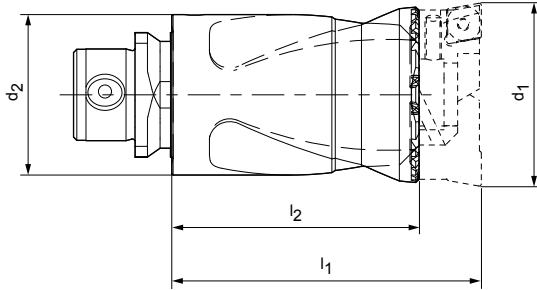

d ₁ min. - max.	d ₂ MBS size	l ₁	l ₂	sw	Specification	Order no.
22 - 30	18,5	40	27,7	17	MBO100-022030-Z2-MBS185	30415217
30 - 39	24,5	50	37,7	22	MBO100-030039-Z2-MBS254	30415218
39 - 50	32	65	48,7	27	MBO100-039050-Z2-MBS320	30415219
50 - 67	42	90	68,2	36	MBO100-050067-Z2-MBS420	30415220
67 - 88	55	115	90,7	46	MBO100-067088-Z2-MBS550	30415221
88 - 115	72	150	113,7	60	MBO100-088115-Z2-MBS720	30415222

Delivery time available on request.

Example

System overview – twin cutting edge tool with MBS

Ø 22 – 115 mm

MBS adapter

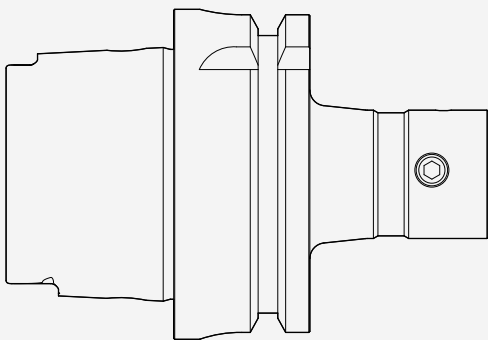

Twin cutting edge tool with MBS

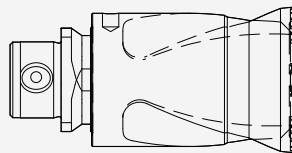

Indexable insert cas-
settes (insert holders)



ModulBore – indexable insert cassettes for twin cutting edge tools

Ø 22 – 115 mm

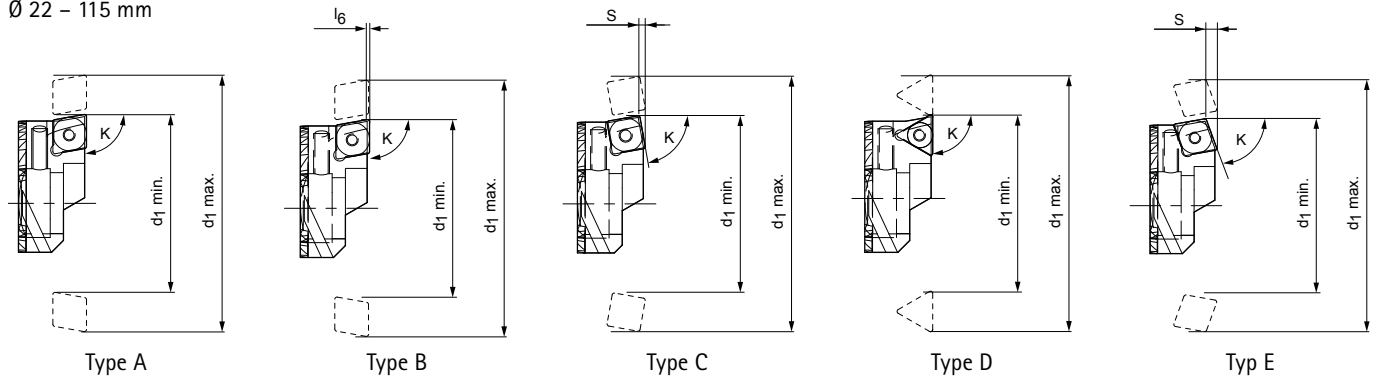

d_1 min. - max.	Type	K	Height offset l_6	S	Indexable insert	Specification	Order no.
22 - 30	A	90°			CC/CP.. 0602	IC-MBO100-022030-A90-C_06	30415185
	B	90°	0,3		CC/CP.. 0602	IC-MBO100-022030-B90-C_06	30415186
	E	70°		2	CC/CP.. 0602	IC-MBO100-022030-E70-C_06	30415187
30 - 39	A	90°			CC/CP.. 0602	IC-MBO100-030039-A90-C_06	30415188
	B	90°	0,3		CC/CP.. 0602	IC-MBO100-030039-B90-C_06	30415189
	C	80°		2	SP.. 0703	IC-MBO100-030039-C80-S_07	30415190
	E	70°		2	CC/CP.. 0602	IC-MBO100-030039-E70-C_06	30415191
39 - 50	A	90°			CC/CP.. 09T3	IC-MBO100-039050-A90-C_09	30415192
	B	90°	0,3		CC/CP.. 09T3	IC-MBO100-039050-B90-C_09	30415193
	C	80°		1,5	SC/SP.. 09T3	IC-MBO100-039050-C80-S_09	30415194
	D	90°			TC/TP.. 09T3	IC-MBO100-039050-D90-T_09	30415195
	E	70°		3,1	CC/CP.. 09T3	IC-MBO100-039050-E70-C_09	30415196
50 - 67	A	90°			CC/CP.. 1204	IC-MBO100-050067-A90-C_12	30415197
	B	90°	0,3		CC/CP.. 1204	IC-MBO100-050067-B90-C_12	30415198
	C	80°		2,1	SC/SP.. 09T3	IC-MBO100-050067-C80-S_09	30415199
	D	90°			TC/TP.. 09T3	IC-MBO100-050067-D90-T_09	30415200
	E	70°		4,1	CC/CP.. 1204	IC-MBO100-050067-E70-C_12	30415201
67 - 88	A	90°			CC/CP.. 1204	IC-MBO100-067088-A90-C_12	30415202
	B	90°	0,3		CC/CP.. 1204	IC-MBO100-067088-B90-C_12	30415203
	C	80°		2,1	SC/SP.. 1204	IC-MBO100-067088-C80-S_12	30415204
	D	90°			TNM.. 16T3	IC-MBO100-067088-D90-T_16	30415205
	E	70°		4,1	CC/CP.. 1204	IC-MBO100-067088-E70-C_12	30415206
88 - 115	A	90°			CC/CP.. 1204	IC-MBO100-088115-A90-C_12	30415207
	B	90°	0,3		CC/CP.. 1204	IC-MBO100-088115-B90-C_12	30415208
	C	80°		2,5	SC/SP.. 1204	IC-MBO100-088115-C80-S_12	30415209
	D	90°			TNM.. 2204	IC-MBO100-088115-D90-T_22	30415210
	E	70°		4,1	CC/CP.. 1204	IC-MBO100-088115-E70-C_12	30415211

Required order quantity: 2 pieces

Delivery time available on request.

ModulBore – boring heads with bridge module

Boring tool for roughing, tool body without indexable insert cassettes

Ø 87 – 202 mm

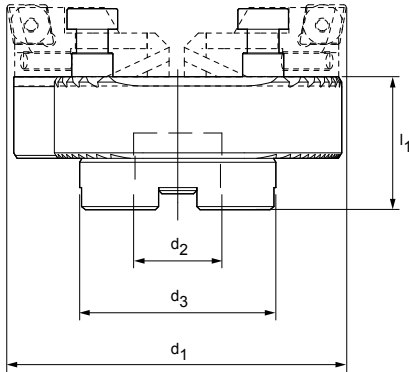

d_1 min. - max.	d_2	d_3	l_1	Specification	Order no.
87 - 110	27	61,5	42	MB0110-087110-Z2-CA27	30415224
109 - 133	27	61,5	42	MB0110-109133-Z2-CA27	30415225
132 - 156	27	62	42	MB0110-132156-Z2-CA27	30415226
155 - 179	27	62	42	MB0110-155179-Z2-CA27	30415227
178 - 202	27	62	42	MB0110-178202-Z2-CA27	30415228

Delivery time available on request.

Example

System overview – boring head with bridge module

Ø 87 – 202 mm

MBS adapter

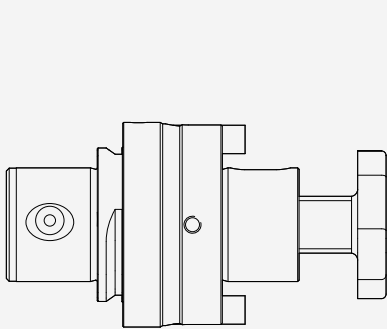

Bridge module

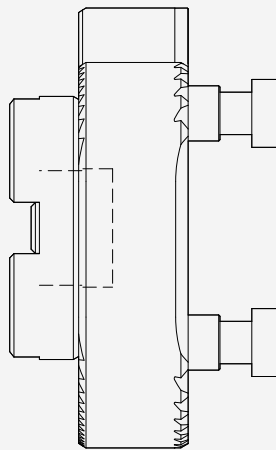

Indexable insert cassettes
(insert holders)

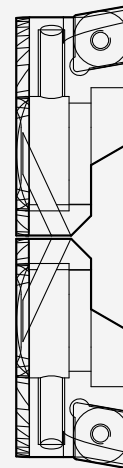

ModulBore – indexable insert cassettes for twin cutting edge tools

Ø 87 – 202 mm

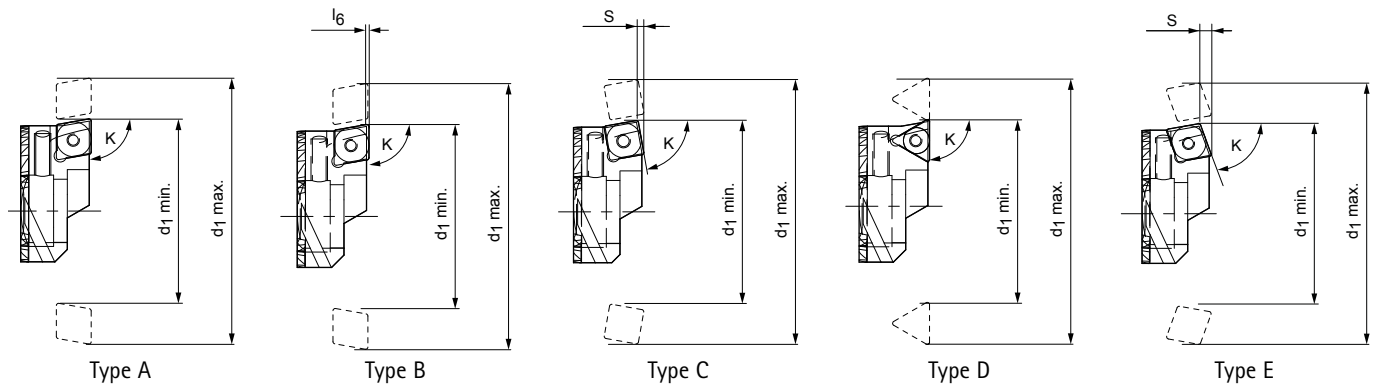

d_1 min. - max.	Type	K	Height offset l_6	S	Indexable insert	Specification	Order no.
87 - 202	A	90°			CC/CP.. 1204	IC-MBO100-067088-A90-C_12	30415202
	B	90°	0,3		CC/CP.. 1204	IC-MBO100-067088-B90-C_12	30415203
	C	80°		2,1	SC/SP.. 1204	IC-MBO100-067088-C80-S_12	30415204
	D	90°			TNM.. 16T3	IC-MBO100-067088-D90-T_16	30415205
	E	70°			4,1	CC/CP.. 1204	IC-MBO100-067088-E70-C_12

Required order quantity: 2 pieces

Delivery time available on request.

ModulBore – boring heads with bridge module

Boring tool for roughing, without slide and cartridge
 Ø 200 – 520 mm

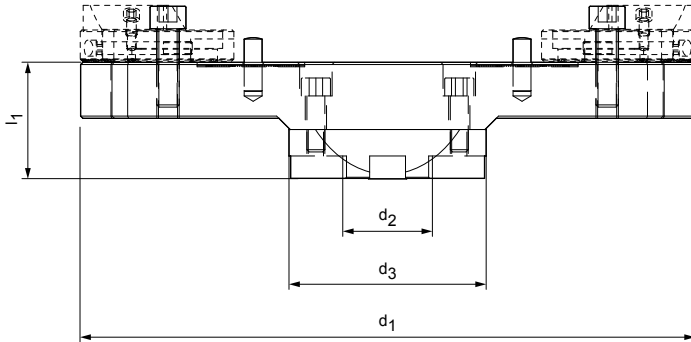

d_1 min. - max.	d_2	d_3	l_1	Specification	Order no.
200 - 280	40	88	51	MB0120-200280-Z2-CA40	30415229
280 - 360	40	88	51	MB0120-280360-Z2-CA40	30415230
360 - 440	40	88	61	MB0120-360440-Z2-CA40	30415231
440 - 520	40	88	61	MB0120-440520-Z2-CA40	30415232

Delivery time available on request.

ModulBore – boring heads with bridge module

Boring tool for roughing, reinforced design produced of aluminium, without slide and cartridge
 Ø 358 – 1,000 mm

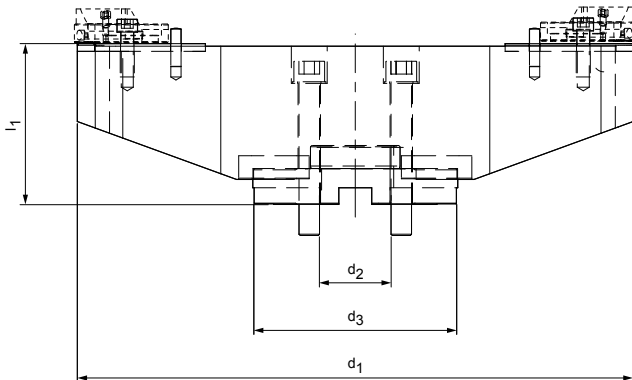

d_1 min. - max.	d_2	d_3	l_1	Specification	Order no.
358 - 440	60	130	91	MB0130-358440-Z2-CA60	30415233
438 - 520	60	130	126	MB0130-438520-Z2-CA60	30415234
518 - 600	60	130	126	MB0130-518600-Z2-CA60	30415235
598 - 680	60	130	126	MB0130-598680-Z2-CA60	30415236
678 - 760	60	130	126	MB0130-678760-Z2-CA60	30415237
758 - 840	60	130	126	MB0130-758840-Z2-CA60	30415238
838 - 920	60	130	126	MB0130-838920-Z2-CA60	30415239
918 - 1000	60	130	126	MB0130-918000-Z2-CA60	30415240

Delivery time available on request.

Dimensions in mm.

ModulBore – slides for ISO cartridges

Ø 200 – 1,000 mm

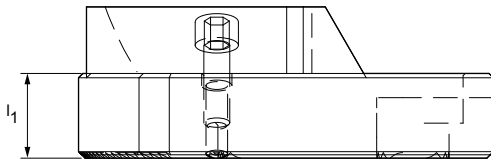

For tool ø d ₁	l ₁	Specification	Order no.
200 – 1.000	19,4	SL-MBO140-2001000	30415309

Delivery time available on request.

ModulBore – ISO cartridges

Ø 200 – 1,000 mm

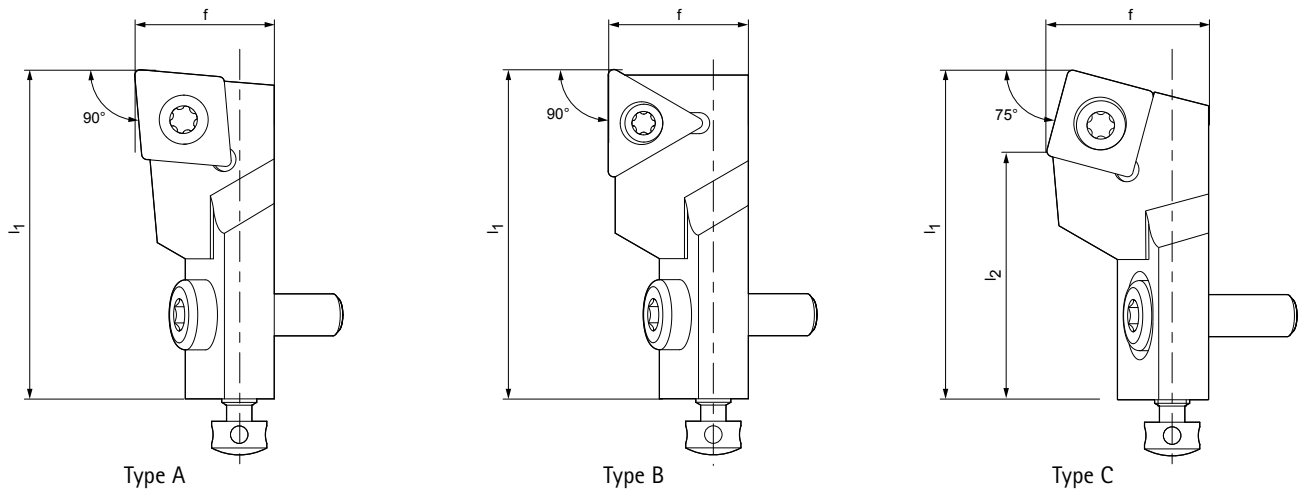

Type	f	l ₁	l ₂	Indexable inserts	Specification	Order no.
A	20	47	-	CC...1204	SCLCL12CA-12	30011071
B	20	47	-	TC16T3	STGCL12CA-16	30011077
C	20	47	35,409	SC...1204	SSRCL12CA-12	30011103

Delivery time available on request.

For spare parts see page 660.

Dimensions in mm.

Example

System overview – boring head with bridge module

Ø 200 – 1,000 mm

Adapter

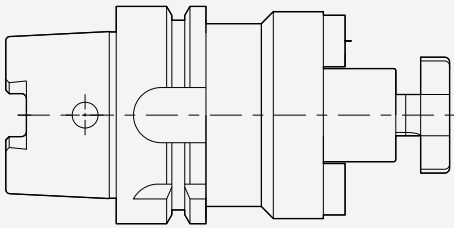

Bridge module

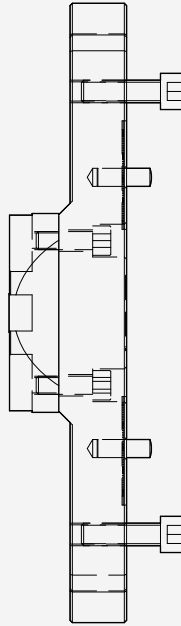

Slide + ISO cartridges

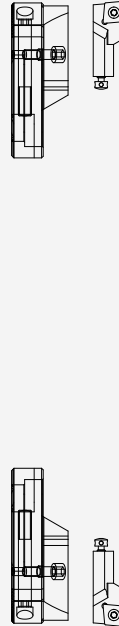

ModulBore – fine boring head

Turning tool for fine machining, tool body without boring bar
 Ø 10 – 28 mm

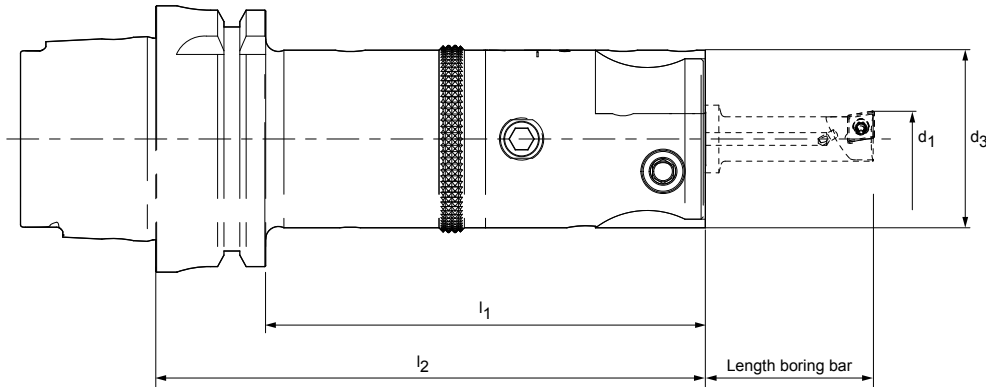

d_1 min. - max.	Shank	d_3	l_1	l_2	Specification	Order no.
10 - 28	MBS	42		95	MB0201-006028-Z1-MBS420	30415248
	MAS BT40	42	76	103	MB0201-006028-Z1-BT040	30415241
	SK40	42	84	103	MB0201-006028-Z1-SK040	30415249
	HSK-A40	42	110	130	MB0201-006028-Z1-HSK-A040	30415242
	HSK-A50	42	104	130	MB0201-006028-Z1-HSK-A050	30415243
	HSK-A63	42	104	130	MB0201-006028-Z1-HSK-A063	30415244
	HSK-A80	42	104	130	MB0201-006028-Z1-HSK-A080	30415245
	HSK-A100	42	101	130	MB0201-006028-Z1-HSK-A100	30415246
	KM40	42		100	MB0201-006028-Z1-KM40	30415247

Coarse adjustment $d_1 = 3 \text{ mm}$ | Fine adjustment range $d_1 = 0.4 \text{ mm}$
 Delivery time available on request.

Example

MBS system overview - fine boring heads

Ø 10 – 28 mm

Adapter

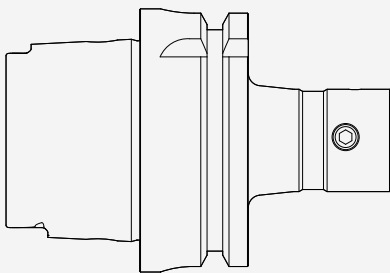

Fine boring head with MBS

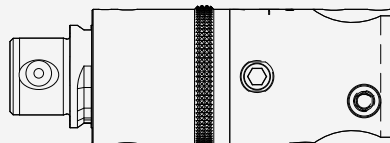

Boring bar

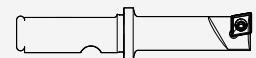

ModulBore – boring bars for fine boring head

Boring bar for fine boring head, with internal coolant supply

Ø 10 – 28 mm

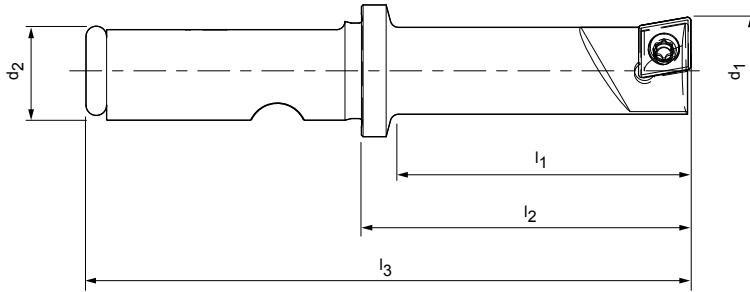

d_1 min. - max.	d_2	l_1	l_2	l_3	Indexable insert	Specification	Order no.
10 - 13	12	30	35	70	CC.. 0602	MB0211-010013-Z1-22	30415260
13 - 16	12	35	40	75	CC.. 0602	MB0211-013016-Z1-22	30415261
16 - 19	12	40	45	80	CC.. 0602	MB0211-016019-Z1-22	30415262
19 - 22	12	50	55	90	CC.. 0602	MB0211-019022-Z1-22	30415263
22 - 25	12	60	65	100	CC.. 0602	MB0211-022025-Z1-22	30415264
25 - 28	12	70	75	110	CC.. 0602	MB0211-025028-Z1-22	30415265

Delivery time available on request.

ModulBore Plus – fine boring bars

Boring tool for fine machining, with internal coolant supply

Ø 14 – 23 mm

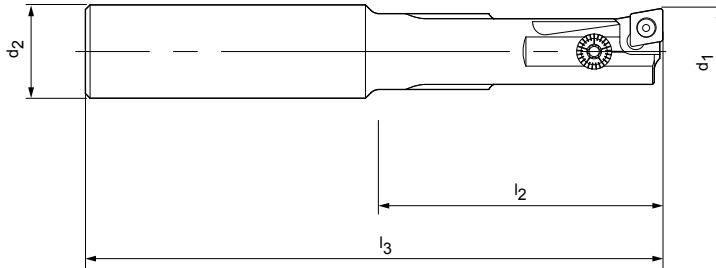

d ₁	d ₂	l ₂	l ₃	Indexable insert	Specification	Order no.
14,0	16	48	99	CC.. 0602	MB0311-0140-Z1-WC16	30415266
14,5	16	48	99	CC.. 0602	MB0311-0145-Z1-WC16	30415267
15,0	16	48	99	CC.. 0602	MB0311-0150-Z1-WC16	30415268
15,5	16	48	99	CC.. 0602	MB0311-0155-Z1-WC16	30415269
16,0	20	54	107	CC.. 0602	MB0311-0160-Z1-WC20	30415270
16,5	20	54	107	CC.. 0602	MB0311-0165-Z1-WC20	30415271
17,0	20	54	107	CC.. 0602	MB0311-0170-Z1-WC20	30415272
17,5	20	54	107	CC.. 0602	MB0311-0175-Z1-WC20	30415273
18,0	20	60	113	CC.. 0602	MB0311-0180-Z1-WC20	30415274
18,5	20	60	113	CC.. 0602	MB0311-0185-Z1-WC20	30415275
19,0	20	60	113	CC.. 0602	MB0311-0190-Z1-WC20	30415276
19,5	20	60	113	CC.. 0602	MB0311-0195-Z1-WC20	30415277
20,0	20	70	125	CC.. 0602	MB0311-0200-Z1-WC20	30415278
20,5	20	70	125	CC.. 0602	MB0311-0205-Z1-WC20	30415279
21,0	20	70	125	CC.. 0602	MB0311-0210-Z1-WC20	30415280
21,5	20	70	125	CC.. 0602	MB0311-0215-Z1-WC20	30415281
22,0	20	70	125	CC.. 0602	MB0311-0220-Z1-WC20	30415282
22,5	20	70	125	CC.. 0602	MB0311-0225-Z1-WC20	30415284
23,0	20	70	125	CC.. 0602	MB0311-0230-Z1-WC20	30415283

Adjustment range of nominal diameter d₁ $\begin{matrix} +0,3 \text{ mm} \\ -0,1 \text{ mm} \end{matrix}$

Delivery time available on request.

ModulBore Plus – fine boring head with MBS

Boring tool for fine machining, with internal coolant supply

Ø 21 – 115 mm

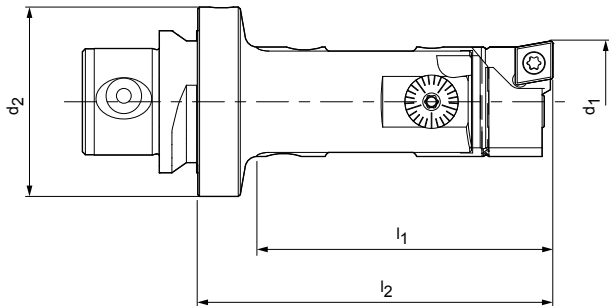

Available on request

d_1 min. - max.	d_2 MBS size	l_1	l_2	Indexable insert	Specification	Order no.
21 - 29	32	50	60	CC.. 0602	MBO401-021029-Z1-MBS320	30415285
29 - 39	24,5	65	65	CC.. 0602	MBO401-029039-Z1-MBS245	30415286
38 - 50	32	75	75	CC.. 0602	MBO401-038050-Z1-MBS320	30415287
50 - 65	42	95	95	CC.. 0602	MBO401-050065-Z1-MBS420	30415289
65 - 88	55	120	120	CC.. 0602	MBO401-065088-Z1-MBS550	30415291
88 - 115	72	150	150	CC.. 0602	MBO401-088115-Z1-MBS720	30415294

Coarse adjustment d_1 , see table | Fine adjustment range $d_1 = 0.4$ mm
 Delivery time available on request.

ModulBore – fine boring head with bridge module

Boring tool for fine machining, without slide and fine boring cartridge
 Ø 87 – 202 mm

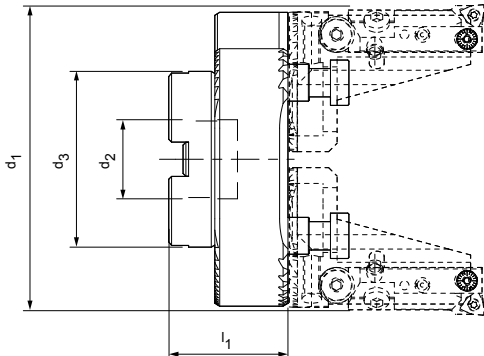

d_1 min. - max.	d_2	d_3	l_1	Specification	Order no.
87 - 110	27	61,5	42	MB0110-087110-Z2-CA27	30415224
109 - 133	27	61,5	42	MB0110-109133-Z2-CA27	30415225
132 - 156	27	62	42	MB0110-132156-Z2-CA27	30415226
155 - 179	27	62	42	MB0110-155179-Z2-CA27	30415227
178 - 202	27	62	42	MB0110-178202-Z2-CA27	30415228

Delivery time available on request.

ModulBore – slides for fine boring cartridge

Ø 87 – 202 mm

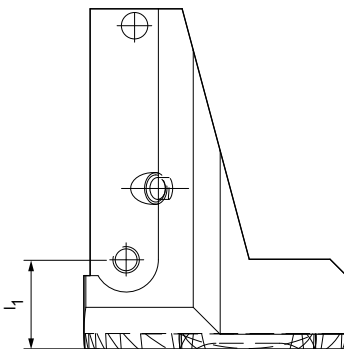

For tool Ø d_1	l_1	Specification	Order no.
87 - 202	16,9	SL-MB0150-087202	30415310

Delivery time available on request.

Example

System overview – fine boring head with bridge module

Ø 87 – 202 mm

Adaptor

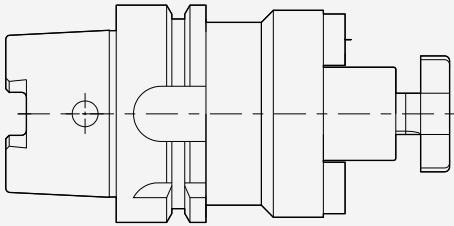

Bridge module

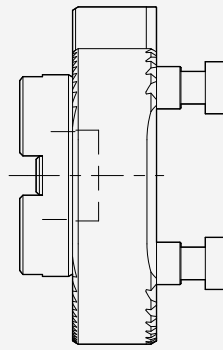

Slide + fine boring cartridge

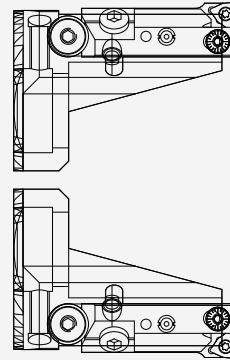

ModulBore – fine boring head with bridge module

Boring tool for fine machining, without slide and fine boring cartridge
 \varnothing 200 – 520 mm

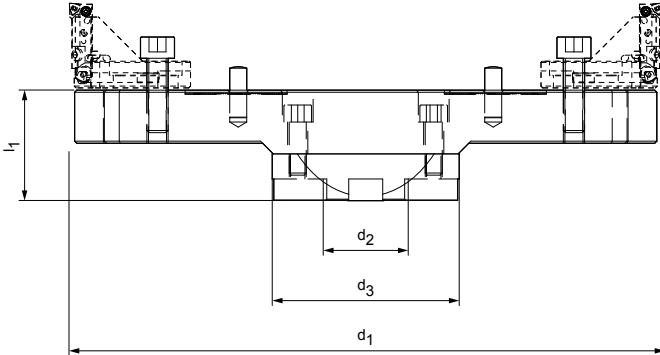

d_1 min. - max.	d_2	d_3	l_1	Specification	Order no.
200 - 280	40	88	51	MB0120-200280-Z2-CA40	30415229
280 - 360	40	88	51	MB0120-280360-Z2-CA40	30415230
360 - 440	40	88	61	MB0120-360440-Z2-CA40	30415231
440 - 520	40	88	61	MB0120-440520-Z2-CA40	30415232

Delivery time available on request.

ModulBore – fine boring head with bridge module

Boring tool for fine machining, reinforced design produced of aluminium, without slide and fine boring cartridge

\varnothing 358 – 1,000 mm

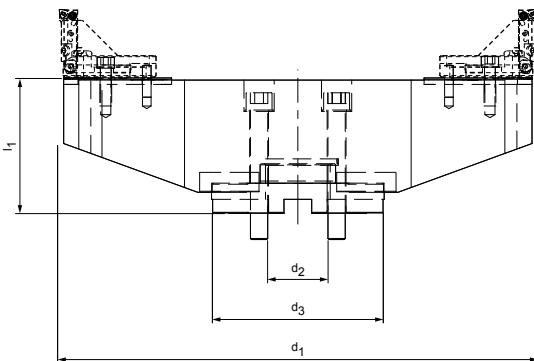

d_1 min. - max.	d_2	d_3	l_1	Specification	Order no.
358 - 440	60	130	91	MB0130-358440-Z2-CA60	30415233
438 - 520	60	130	126	MB0130-438520-Z2-CA60	30415234
518 - 600	60	130	126	MB0130-518600-Z2-CA60	30415235
598 - 680	60	130	126	MB0130-598680-Z2-CA60	30415236
678 - 760	60	130	126	MB0130-678760-Z2-CA60	30415237
758 - 840	60	130	126	MB0130-758840-Z2-CA60	30415238
838 - 920	60	130	126	MB0130-838920-Z2-CA60	30415239
918 - 1.000	60	130	126	MB0130-918000-Z2-CA60	30415240

Delivery time available on request.

Dimensions in mm.

ModulBore – slides for fine boring cartridge

Ø 200 – 1,000 mm

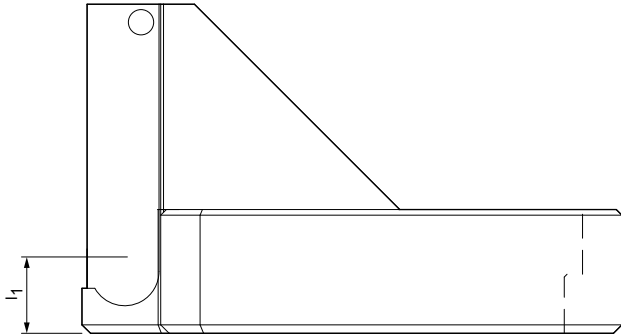

For tool ø d ₁	l ₁	Specification	Order no.
200 - 1.000	13,1	SL-MBO150-2001000	30415311

Matching counterweight for single-bladed spindle machining, order no. 30522418.
Delivery time available on request.

Example

System overview – fine boring head with bridge module

Ø 200 – 1,000 mm

Adapter

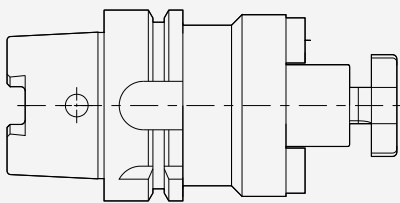

Bridge module

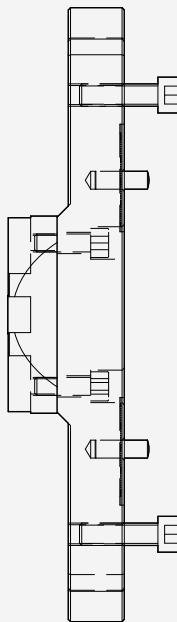

Slide + fine boring cartridge + imbalance compensation

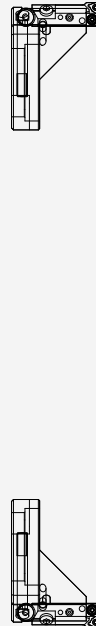

ModulBore – fine boring head cartridges

Ø 87 – 1,000 mm

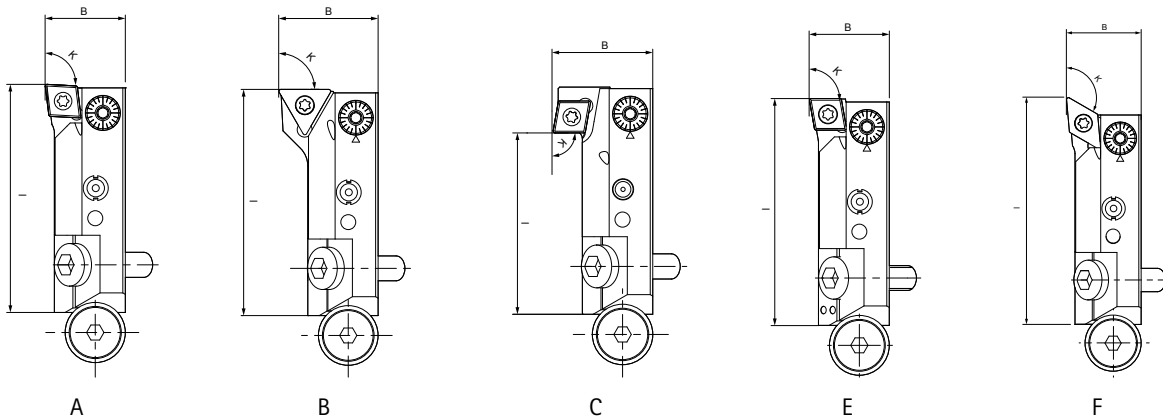

Type	l	B	K	Design	Indexable insert	Specification	Order no.
A	45,5	16	93°	right	CC..0602	MBO501-R-093-16-CC_0602	10030384
A	45,5	16	93°	left	CC..0602	MBO501-L-093-16-CC_0602	30415298
B	45,5	20	90°	right	TC..1102	MBO501-R-090-20-TC_1102	30355664
B	45,5	20	90°	left	TC..1102	MBO501-L-090-20-TC_1102	30353989
C	36	20	90°	backward	CC..0602	MBO501-B-090-20-CC_0602	30415297
A	45,5	16	95°	right	CC..0602	MBO501-R-095-16-CC_0602	10078197
A	45,5	16	95°	left	CC..0602	MBO501-L-095-16-CC_0602	30415299
E	45,5	16	90°	right	CC..0602	MBO501-R-090-16-CC_0602	10078198
E	45,5	16	90°	left	CC..0602	MBO501-L-090-16-CC_0602	10078199

With 10 µm fine adjustment feature | Adjustment range related to dimension B + 0.6 mm Ø
Delivery time available on request.

Available on request

Type	l	B	k	Design	WSP	Specification	Order no.
F	48,5	16	120° (5°)	left	DC..0702	MBO501-L-120-16-DC_0702	30415305
F	45,8	16	120° (5°)	right	DC..0702	MBO501-R-120-16-DC_0702	30415302
A	45,5	22	95°	left	CC..09T3	MBO501-L-095-22-CC_09T3	30415304
A	45,5	22	95°	right	CC..09T3	MBO501-R-095-22-CC_09T3	30415301

ModulBore Plus – fine boring head cartridges

Type	l	B	K	Design	Indexable insert	Specification	Order no.
A	45,5	16	93°	right	CC..0602	MBO511-R-093-16-CC_0602	30415307
A	45,5	16	95°	right	CC..0602	MBO511-R-095-16-CC_0602	30415308
A	45,5	16	90°	right	CC..0602	MBO511-R-090-16-CC_0602	30415306

With 2 µm fine adjustment feature | Adjustment range based on dimension B + 0.5 mm Ø
Delivery time available on request.

MBS adapter

Shank SK according to ISO 7388-1 Form AD/AF

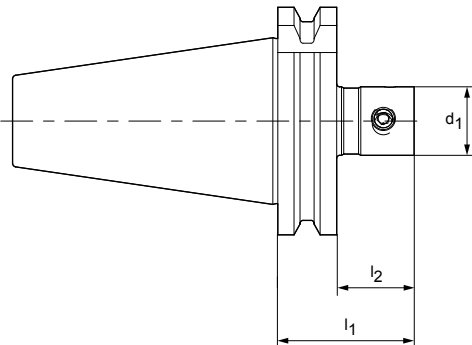

Steep taper	d ₁ MBS size	l ₁	l ₂	Specification	Order no.
40	18,5	60	40	MBS101-N-185-040-SK040-S	30415332
40	24,5	60	40	MBS101-N-245-060-SK040-S	30415333
40	32	60	40	MBS101-N-320-060-SK040-S	30415334
40	42	60	40	MBS101-N-420-060-SK040-S	30415335
40	55	65	45	MBS101-N-550-065-SK040-S	30415336
50	18,5	40	20	MBS101-N-185-040-SK050-S	30415337
50	24,5	40	20	MBS101-N-245-040-SK050-S	30415338
50	32	60	40	MBS101-N-320-060-SK050-S	30415339
50	42	60	40	MBS101-N-420-060-SK050-S	30415340
50	55	60	40	MBS101-N-550-060-SK050-S	30415341
50	72	65	45	MBS101-N-720-065-SK050-S	30415342

Delivery time available on request.

MBS adapter

Shank BT as per ISO 7388-2, form J (JIS B 6339)

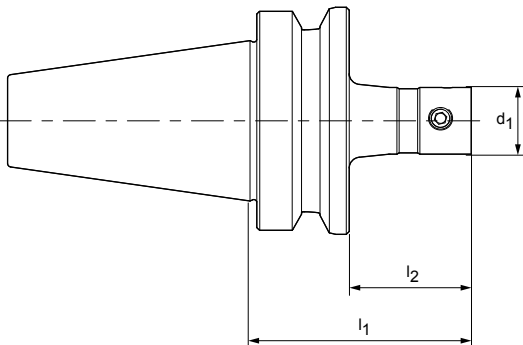

BT	d_1 MBS size	l_1	l_2	Specification	Order no.
40	18,5	40	33	MBS101-N-185-060-BT040-S	30415344
40	24,5	40	33	MBS101-N-245-060-BT040-S	30415345
40	32	60	33	MBS101-N-320-060-BT040-S	30415346
40	42	60	33	MBS101-N-420-060-BT040-S	30415347
40	55	60	33	MBS101-N-550-065-BT040-S	30415348
50	18,5	40	-	MBS101-N-185-040-BT050-S	30415349
50	24,5	40	-	MBS101-N-245-040-BT050-S	30415350
50	32	60	22	MBS101-N-320-060-BT050-S	30415351
50	42	60	22	MBS101-N-420-060-BT050-S	30415352
50	55	60	27	MBS101-N-550-065-BT050-S	30415353
50	72	60	32	MBS101-N-720-070-BT050-S	30415354

Delivery time available on request.

MBS adapter

Shank hollow shank taper-A according to DIN 69893-1

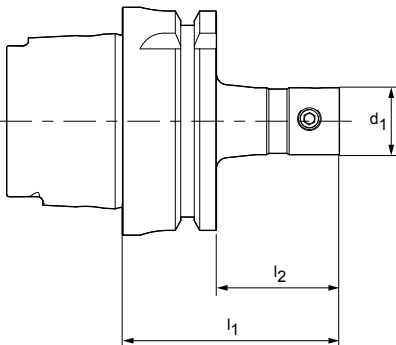

HSK-A	d_1 MBS size	l_1	l_2	Specification	Order no.
63	18,5	60	34	MBS101-N-185-060-HSK-A063-S	30415367
63	24,5	60	34	MBS101-N-245-060-HSK-A063-S	30415368
63	32	60	34	MBS101-N-320-060-HSK-A063-S	30415369
63	42	70	44	MBS101-N-420-070-HSK-A063-S	30415370
63	55	80	54	MBS101-N-550-080-HSK-A063-S	30415371
63	72	95	69	MBS101-N-720-095-HSK-A063-S	30415372
100	32	70	41	MBS101-N-320-070-HSK-A100-S	30415373
100	42	80	51	MBS101-N-420-080-HSK-A100-S	30415374
100	55	90	61	MBS101-N-420-550-HSK-A100-S	30415375
100	72	105	76	MBS101-N-720-105-HSK-A100-S	30415376

Delivery time available on request.

MBS extensions

MBS to MBS

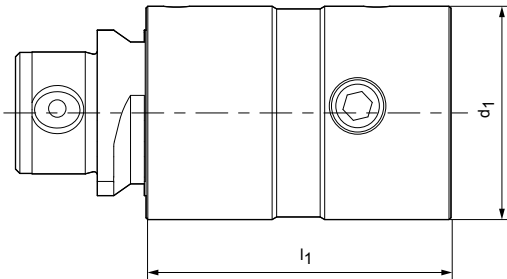

d ₁ MBS size	l ₁	Specification	Order no.
18,5	30	MBS185-MBS185-030-01	30415380
18,5	35	MBS185-MBS185-035-01	30415381
24,5	30	MBS245-MBS245-030-01	30415382
24,5	35	MBS245-MBS245-035-01	30415383
24,5	45	MBS245-MBS245-045-01	30415384
32	40	MBS320-MBS320-040-01	30415385
32	50	MBS320-MBS320-050-01	30415386
32	60	MBS320-MBS320-060-01	30415387
42	50	MBS420-MBS420-050-01	30415388
42	60	MBS420-MBS420-060-01	30415389
42	80	MBS420-MBS420-080-01	30415390
55	70	MBS550-MBS550-070-01	30415391
55	90	MBS550-MBS550-090-01	30415392
55	105	MBS550-MBS550-105-01	30415393
72	75	MBS720-MBS720-075-01	30415394
72	100	MBS720-MBS720-100-01	30415395
72	135	MBS720-MBS720-135-01	30415396

Delivery time available on request.

MBS reducers

MBS to MBS

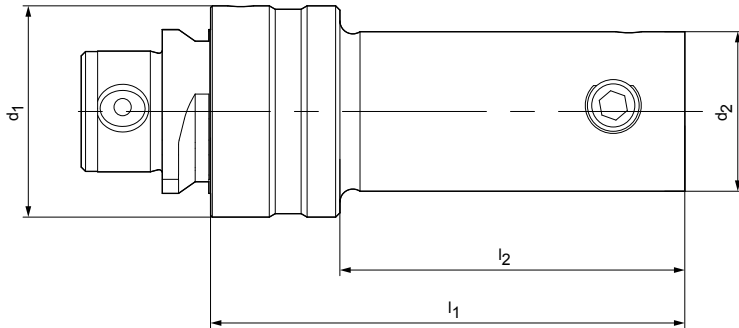

d_1 MBS size	d_2 MBS size	l_1	l_2	Specification	Order no.
24,5	18,5	30	15	MBS245-MBS185-030-01	30415399
32	18,5	30	51	MBS320-MBS185-030-01	30415401
32	24,5	40	25	MBS320-MBS245-040-01	30415403
42	18,5	35	15	MBS420-MBS185-035-01	30415405
42	24,5	45	25	MBS420-MBS245-045-01	30415407
42	32	45	25	MBS420-MBS320-045-01	30415409
55	18,5	40	15	MBS550-MBS185-040-01	30415411
55	24,5	50	25	MBS550-MBS245-050-01	30415413
55	32	50	25	MBS550-MBS320-050-01	30415415
55	42	55	30	MBS550-MBS420-055-01	30415417
72	42	60	30	MBS720-MBS420-060-01	30415419
72	55	60	30	MBS720-MBS550-060-01	30415420

Delivery time available on request.

ModulBore – arbors

With cross slot and MBS
Shank MBS

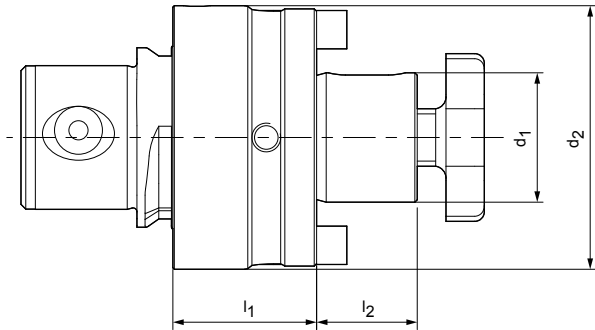

MBS size	d_1	d_2	l_1	l_2	Specification	Order no.
MBS420	27	42	30	21	MCA-MBS420-27-30-1-0-W	30415312
MBS550	27	55	30	21	MCA-MBS550-27-30-1-0-W	30415313
MBS720	40	72	35	27	MCA-MBS720-40-35-1-0-W	30415314

Delivery time available on request.

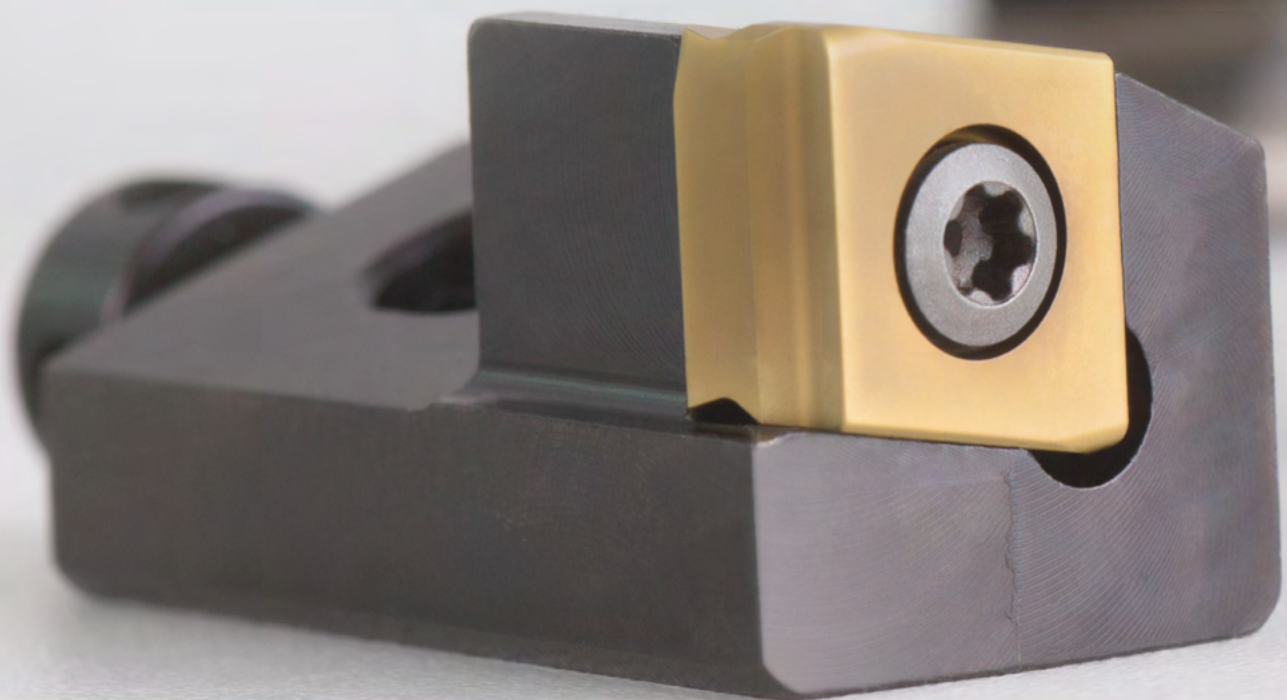

CARTRIDGES

Along with the adjusting feature with a long adjustment range, cartridges offer numerous possibilities for various applications as they can be interchanged quickly and straightforwardly. Cartridges are used for both internal and external machining tasks. In case of changes, for example, to chamfer angles, or in case of repair, cartridges can be interchanged without major effort.

The range of MAPAL cartridges covers the bulk of installation variants in engineering. Along with the standardised ISO cartridges, a series of compact cartridges for radial and tangential indexable inserts are available. Due to short lengths, these offer even more engineering freedom during the design of custom tools.

On request, MAPAL also supplies cartridges and compact cartridges in custom designs.

Cartridges

Product ID codes	644
ISO cartridges	646
Compact cartridges	650
Compact cartridges for tangential indexable inserts	656
Accessories	660

MAPAL compact cartridge sizes compared to ISO cartridges

Example: Indexable insert size 09

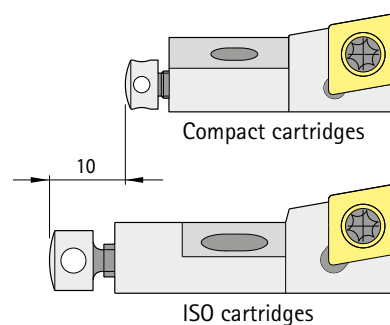

Product ID codes

Cartridges and compact cartridges

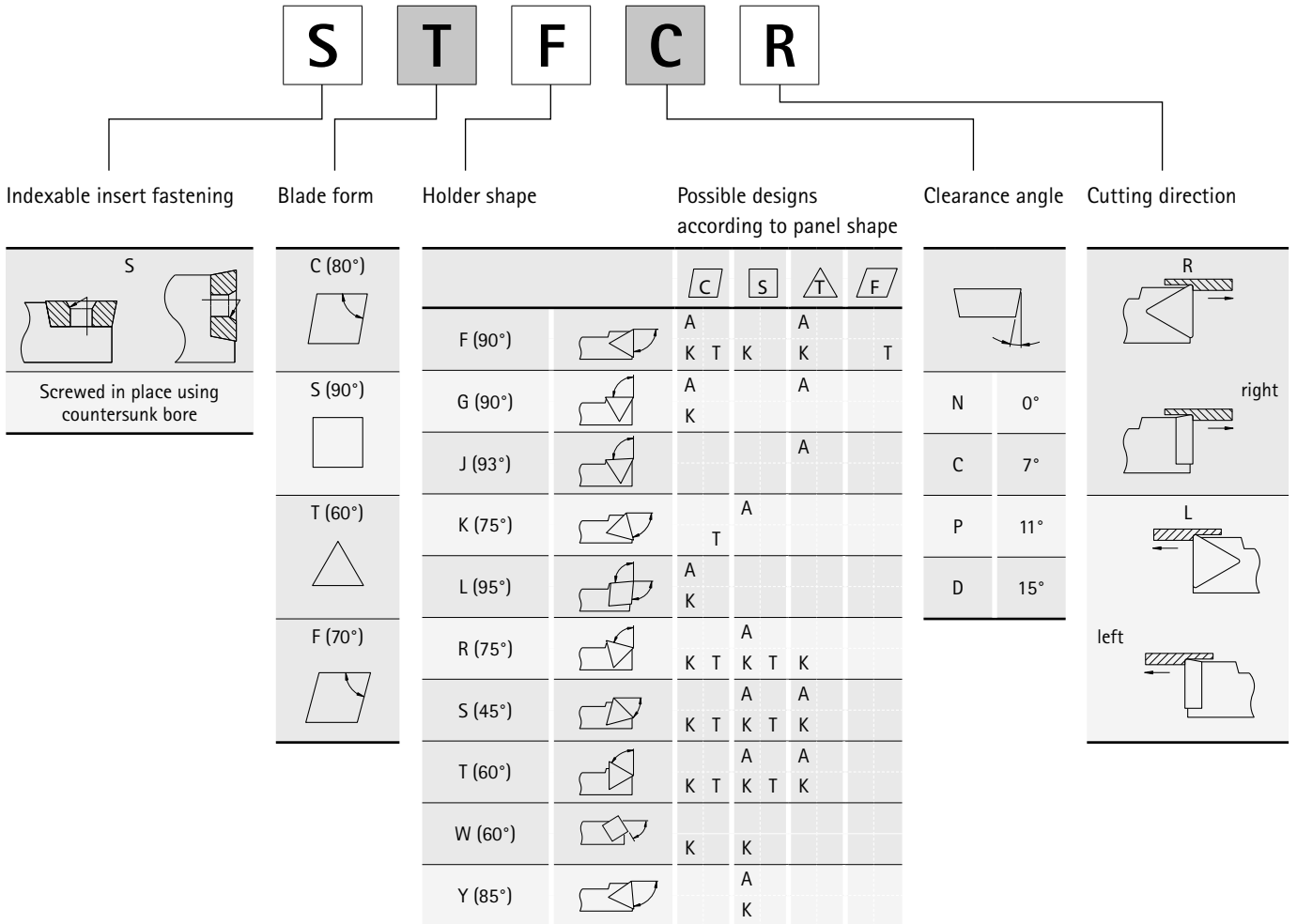

A = Cartridge
K = Compact cartridge
T = Compact cartridges for tangential indexable inserts

Compact cartridges with custom angle
Data on the holder shape directly via the setting angle

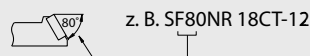
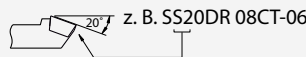

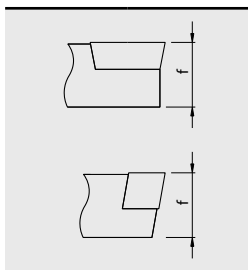
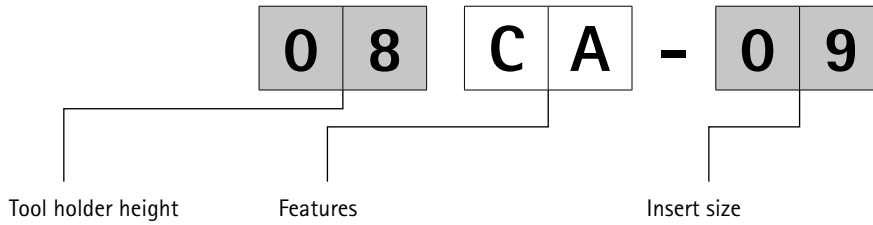

Height data	
Identification number	[mm]
06	6,0
08	8,0
10	10,0
12	12,0
14	14,0
18	18,0

1st letter	Significance
C	Cartridge

2nd letter	Significance
A	Cartridges in accordance with DIN 4985
K	Compact cartridges similar to DIN 4985
T	Compact cartridges similar to DIN 4985 for tangential indexable inserts

Incircle	d			
	C	S	T	F
d [mm]	C	S	T	F
5,56	05	-	09	-
6,35	06	06	11	06
9,525	09	09	16	09
12,7	12	12	-	12

ISO cartridges

Form F, G

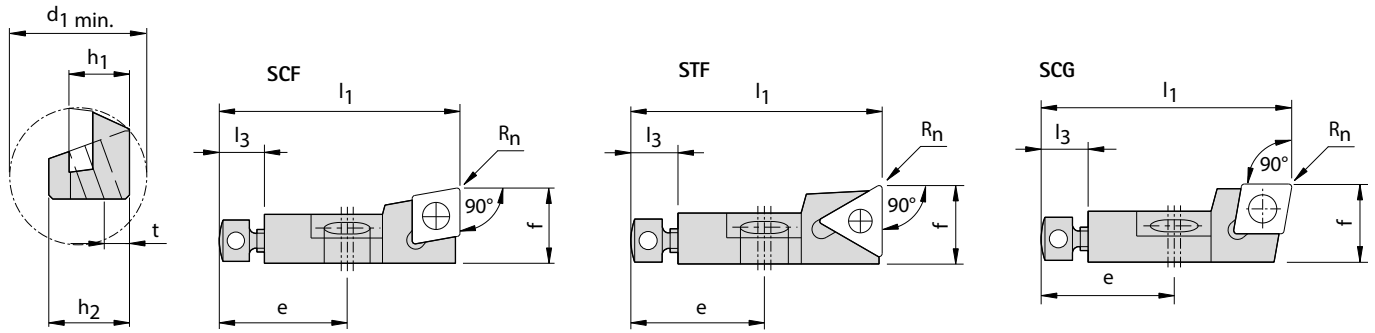

Drawings of right design, example SCFCR.

Preferred series in stock

	Specification	Related indexable insert	Dimensions									Accessory group *	Order no.
			h_1	f (refers to R_n)	R_n	l_1	e	l_3	h_2	t	$d_1 \text{ min.}$		
SCF...	SCFCR 08CA-06	CC_0602_	8	10	0,4	32	17	6	9,5	4,5	25	3	30011050
	SCFCL 08CA-06	CC_0602_	8	10	0,4	32	17	6	9,5	4,5	25	3	30011051
	SCFPR 08CA-06	CP_0602_	8	10	0,4	32	17	6	9,5	4,5	25	3	30011052
	SCFPL 08CA-06	CP_0602_	8	10	0,4	32	17	6	9,5	4,5	25	3	30011053
	SCFCR 10CA-09	CC_09T3_	10	14	0,8	50	20	8	13	5	40	5	30011054
	SCFCR 12CA-12	CC_1204_	12	20	0,8	55	20	8	17	6	50	1	30011056
	SCFCL 12CA-12	CC_1204_	12	20	0,8	55	20	8	17	6	50	1	30011057
STF...	STFCR 08CA-09	TC_0902_	8	10	0,4	32	17	6	9,5	4,5	25	2	30011058
	STFCR 10CA-11-02	TC_1102_	10	14	0,4	50	20	8	13	5	40	4	30011060
	STFCR 12CA-16	TC_16T3_	12	20	0,8	55	20	8	17	6	50	6	30011062
SCG...	SCGCR 08CA-06	CC_0602_	8	10	0,4	32	17	6	9,5	4,5	25	3	30011064
	SCGCL 08CA-06	CC_0602_	8	10	0,4	32	17	6	9,5	4,5	25	3	30011065
	SCGCR 10CA-09	CC_09T3_	10	14	0,8	50	20	8	13	5	40	5	30011068

* see pages 660-661

ISO cartridges

Form J, K, L

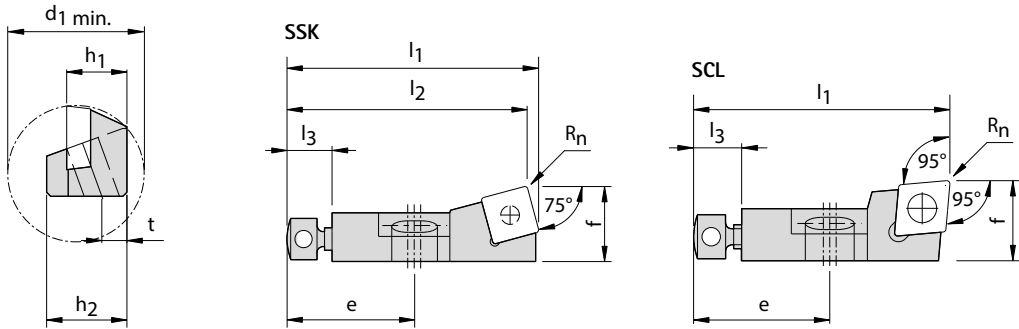

Drawings of right design, example STJCR.

Preferred series in stock

	Specification	Related indexable insert	Dimensions										Accessory group	Order no.
			h_1	f (refers to Rn)	R_n	l_1	l_2	e	l_3	h_2	t	d_1 min.		
SSK...	SSKCR 10CA-09	SC_09T3__	10	14	0,8	52,2	50	20	8	13	5	40	5	30011086
	SSKCL 10CA-09	SC_09T3__	10	14	0,8	52,2	50	20	8	13	5	40	5	30011087
	SSKCR 12CA-12	SC_1204__	12	20	0,8	58,1	55	20	8	17	6	50	1	30011088
SCL...	SCLCR 10CA-09	CC_09T3__	10	14	0,8	50	-	20	8	13	5	40	5	30011094
	SCLCL 10CA-09	CC_09T3__	10	14	0,8	50	-	20	8	13	5	40	5	30011095
	SCLCL 12CA-12	CC_1204__	12	20	0,8	55	-	20	8	17	6	50	1	30011097

* see pages 660-661

Other cutting edge forms, sizes and contact angles available upon request.
 Scope of delivery: Cartridge with add-on parts. Please order indexable inserts and accessories separately.
 Dimensions in mm.

ISO cartridges

Form R, S

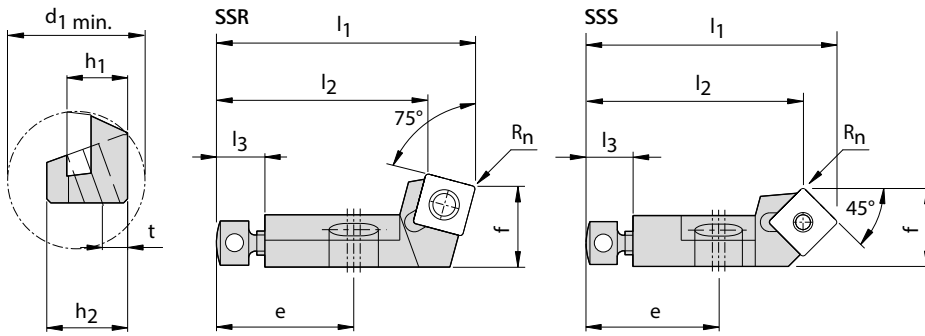

Drawings of right design, example SSRCR.

Preferred series in stock

	Specification	Related indexable insert	Dimensions										Accessory group *	Order no.
			h_1	f (refers to R_n)	R_n	l_1	l_2	e	l_3	h_2	t	$d_1 \text{ min.}$		
SSR...	SSRCR 08CA-06	SC_0602__	8	10	0,4	32	26,4	17	6	9,5	4,5	25	3	30011098
	SSRCR 10CA-09	SC_09T3__	10	14	0,8	50	41,3	20	8	13	5	40	5	30011100
	SSRCR 12CA-12	SC_1204__	12	20	0,8	55	43,5	20	8	17	6	50	1	30011102
	SSRCL 12CA-12	SC_1204__	12	20	0,8	55	43,5	20	8	17	6	50	1	30011103
SSS...	SSSCR 08CA-06	SC_0602__	8	10	0,4	32,4	28	17	6	9,5	4,5	25	3	30011104
	SSSCL 08CA-06	SC_0602__	8	10	0,4	32,4	28	17	6	9,5	4,5	25	3	30011105
	SSSCR 10CA-09	SC_09T3__	10	14	0,8	50,1	44	20	8	13	5	40	5	30011106

* see pages 660-661

ISO cartridges

Form T, Y

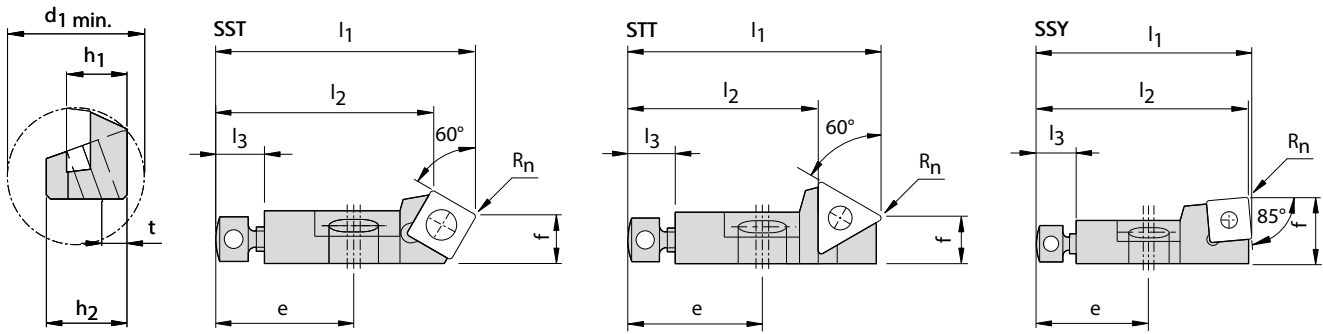

Drawings of right design, example SSTCR.

Preferred series in stock

	Specification	Related indexable insert	Dimensions										Accessory group	Order no.
			h_1	f (refers to R_n)	R_n	l_1	l_2	e	l_3	h_2	t	$d_1 \text{ min.}$		
SST...	SSTCR 10CA-09	SC_09T3__	10	13,3	0,8	50	40,6	20	8	13	5	40	5	30011118
	SSTCL 10CA-09	SC_09T3__	10	13,3	0,8	50	40,6	20	8	13	5	40	5	30011119
	SSTCR 12CA-12	SC_1204__	12	18,9	0,8	55	44,8	20	8	17	6	50	1	30011120
STT...	STTCR 08CA-09	TC_0902__	8	10,3	0,4	32	24,6	17	6	9,5	4,5	25	2	30011122
	STTCR 10CA-11-02	TC_1102__	10	14	0,4	50	41,4	20	8	13	5	40	4	30011124
SSY...	SSYCR 10CA-09	SC_09T3__	10	14	0,8	50,8	50	20	8	13	5	40	5	30011130
	SSYCR 12CA-12	SC_1204__	12	20	0,8	56	55	20	8	17	6	50	1	30011132

* see pages 660-661

Other cutting edge forms, sizes and contact angles available upon request.
 Scope of delivery: Cartridge with add-on parts. Please order indexable inserts and accessories separately.
 Dimensions in mm.

Compact cartridges

Form F

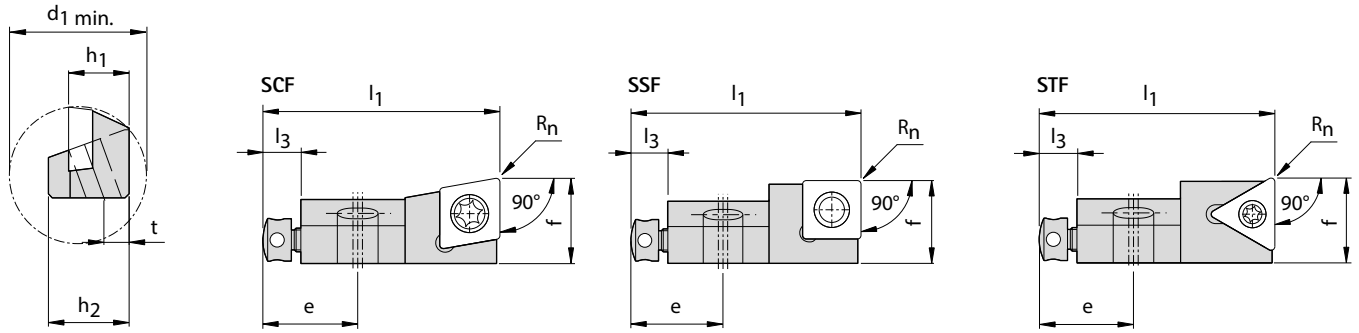

Drawings of right design, example SCFCR.

Preferred series in stock

	Specification	Related indexable insert	Dimensions									Accessory group *	Order no.
			h_1	f (refers to Rn)	R_n	l_1	e	l_3	h_2	t	$d_{1 \text{ min.}}$		
SCF...	SCFCR 06CK-06 V1	CC_0602_	6	8,5	0,4	25	11	5	6	2,5	18	9	30011134
	SCFCL 06CK-06 V1	CC_0602_	6	8,5	0,4	25	11	5	6	2,5	18	9	30011135
	SCFCR 06CK-06 V2	CC_0602_	6	9,7	0,4	25	11	5	6	2,5	18	9	30011136
	SCFCR 10CK-09	CC_09T3_	10	14	0,8	40	17	8	15	5	33	14	30011138
	SCFCL 10CK-09	CC_09T3_	10	14	0,8	40	17	8	15	5	33	14	30011139
	SCFCR 12CK-12	CC_1204_	12	18	0,8	50	20	8	16	5	37	7	30011140
	SCFCL 12CK-12	CC_1204_	12	18	0,8	50	20	8	16	5	37	7	30011141
SSF...	SSFPR 08CK-06	SP_0603_	8	10	0,4	32	17	5	10	4,5	24	13	30011142
	SSFCR 10CK-09	SC_09T3_	10	14	0,8	44	17	8	15	5	33	16	30011144
	SSFCR 12CK-12	SC_1204_	12	18	0,8	50	20	8	16	5	37	7	30011146
	SSFCL 12CK-12	SC_1204_	12	18	0,8	50	20	8	16	5	37	7	30011147
STF...	STFCR 06CK-09	TC_0902_	6	10	0,4	25	11	5	6	2,5	18	17	30011148
	STFCR 10CK-11	TC_1102_	10	14	0,4	40	17	8	15	5	33	11	30011150
	STFCR 12CK-16	TC_16T3_	12	18	0,8	50	20	8	16	5	37	12	30011152

* see pages 660-661

Compact cartridges

Form G, L

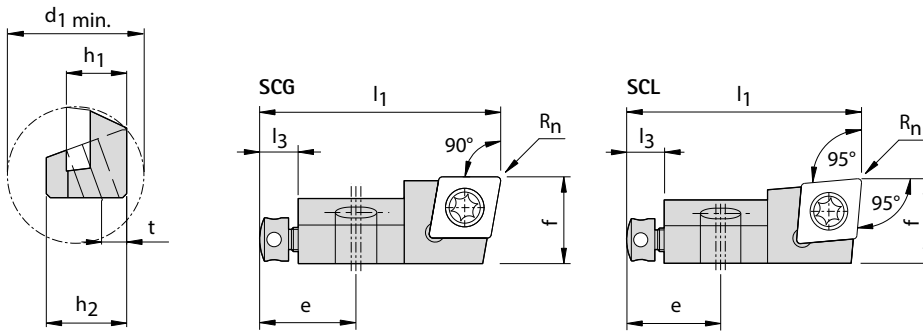

Drawings of right design, example SCGCR.

Preferred series in stock

	Specification	Related indexable insert	Dimensions									Accessory group *	Order no.
			h_1	f (refers to R_n)	R_n	l_1	e	l_3	h_2	t	$d_1 \text{ min.}$		
SCG...	SCGCR 06CK-06 V1	CC_0602__	6	8,5	0,4	25	11	5	6	2,5	18	10	30011154
	SCGCL 06CK-06 V1	CC_0602__	6	8,5	0,4	25	11	5	6	2,5	18	10	30011155
	SCGCR 10CK-09	CC_09T3__	10	14	0,8	40	17	8	15	5	33	15	30011158
	SCGCL 10CK-09	CC_09T3__	10	14	0,8	40	17	8	15	5	33	15	30011159
	SCGCR 12CK-12	CC_1204__	12	18	0,8	50	20	8	16	5	37	8	30011160
	SCGCL 12CK-12	CC_1204__	12	18	0,8	50	20	8	16	5	37	8	30011161
SCL...	SCLCR 06CK-06 V1	CC_0602__	6	8,5	0,4	25	11	5	6	2,5	18	10	30011162
	SCLCL 06CK-06 V1	CC_0602__	6	8,5	0,4	25	11	5	6	2,5	18	10	30011163
	SCLCR 06CK-06 V2	CC_0602__	6	9,7	0,4	25	11	5	6	2,5	18	10	30011164
	SCLCL 06CK-06 V2	CC_0602__	6	9,7	0,4	25	11	5	6	2,5	18	10	30011165
	SCLCR 10CK-09	CC_09T3__	10	14	0,8	40	17	8	15	5	33	15	30011166
	SCLCL 10CK-09	CC_09T3__	10	14	0,8	40	17	8	15	5	33	15	30011167
	SCLCR 12CK-12	CC_1204__	12	18	0,8	50	20	8	16	5	37	7	30011168
	SCLCL 12CK-12	CC_1204__	12	18	0,8	50	20	8	16	5	37	7	30011169

* see pages 660-661

Other cutting edge forms, sizes and contact angles available upon request.

Scope of delivery: Cartridge with add-on parts. Please order indexable inserts and accessories separately.

Dimensions in mm.

Compact cartridges

Form R

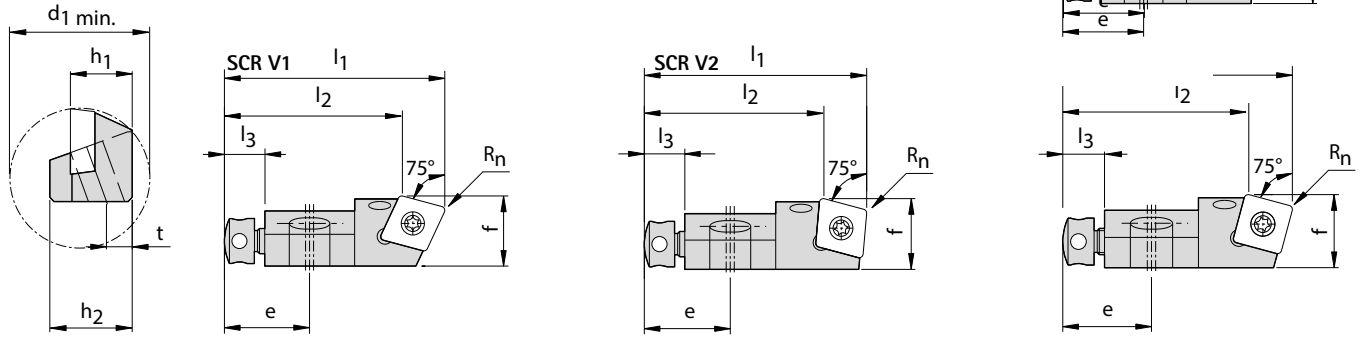

Drawings of right design, example SCRCR.

Preferred series in stock

	Specification	Related indexable insert	Dimensions										Accessory group *	Order no.
			h_1	f (refers to R_n)	R_n	l_1	l_2	e	l_3	h_2	t	$d_1 \text{ min.}$		
SCR...V1	SCRCR 06CK-06 V1	CC_0602__	6	9,7	0,4	25	19,2	11	5	6	2,5	18	9	30011170
	SCRCR 10CK-09 V1	CC_09T3__	10	14	0,8	44	35,5	17	8	15	5	33	14	30011172
SCR...V2	SCRCR 06CK-06 V2	CC_0602__	6	10	0,4	25	19,2	11	5	6	2,5	18	9	30011174
	SCRCR 10CK-09 V2	CC_09T3__	10	14	0,8	44	35,5	17	8	15	5	33	16	30011176
SSR...	SSRPR 08CK-06	SP_0603__	8	10	0,4	32	26,3	17	5	10	4,5	24	13	30011178
	SSRCR 10CK-09	SC_09T3__	10	14	0,8	44	35,7	17	8	15	5	33	16	30011180
	SSRCL 10CK-09	SC_09T3__	10	14	0,8	44	35,7	17	8	15	5	33	16	30011181
	SSRCR 12CK-12	SC_1204__	12	18	0,8	50	38,6	20	8	16	5	37	7	30011182
STR...	STRCR 10CK-11	TC_1102__	10	14	0,4	40	30,4	17	8	15	5	33	11	30011186
	STRCR 12CK-16	TC_16T3__	12	18	0,8	50	36,1	20	8	16	5	37	12	30011188

* see pages 660-661

Other cutting edge forms, sizes and contact angles available upon request.
 Scope of delivery: Cartridge with add-on parts. Please order indexable inserts and accessories separately.
 Dimensions in mm.

Compact cartridges

Form S

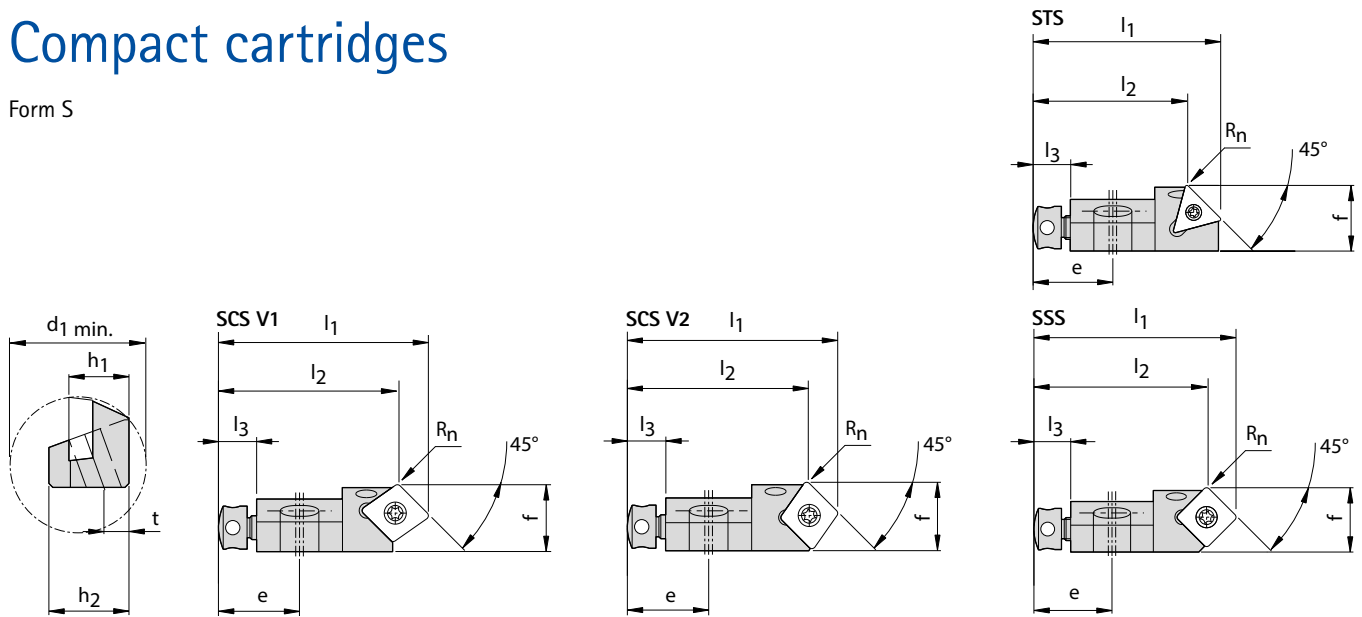

Drawings of right design, example SCSCR.

Preferred series in stock

	Specification	Related indexable insert	Dimensions										Accessory group *	Order no.
			h_1	f (refers to R_n)	R_n	l_1	l_2	e	l_3	h_2	t	$d_1 \text{ min.}$		
SCS...V1	SCSCR 06CK-06 V1	CC_0602__	6	9,7	0,4	25	20,8	11	5	6	2,5	18	9	30011190
	SCSCR 10CK-09 V1	CC_09T3__	10	14	0,8	44	37,8	17	8	15	5	33	14	30011192
SCS...V2	SCSCR 06CK-06 V2	CC_0602__	6	10	0,4	25	20,8	11	5	6	2,5	18	9	30011194
	SCSCR 10CK-09 V2	CC_09T3__	10	14,3	0,8	44	37,8	17	8	15	5	33	14	30011196
SSS...	SSSPR 08CK-06	SP_0603__	8	10	0,4	32	27,8	17	5	10	4,5	24	13	30011198
	SSSPL 08CK-06	SP_0603__	8	10	0,4	32	27,8	17	5	10	4,5	24	13	30011199
	SSSCR 10CK-09	SC_09T3__	10	14	0,8	44	37,9	17	8	15	5	33	14	30011200
	SSSCL 10CK-09	SC_09T3__	10	14	0,8	44	37,9	17	8	15	5	33	14	30011201
	SSSCR 12CK-12	SC_1204__	12	18	0,8	50	41,7	20	8	16	5	37	7	30011202
STS...	STSCR 06CK-09	TC_0902__	6	10	0,4	25	18,9	11	5	6	2,5	18	17	30011204
	STSCR 10CK-11	TC_1102__	10	14	0,4	40	33	17	8	15	5	33	11	30011206

* see pages 660-661

Other cutting edge forms, sizes and contact angles available upon request.

Scope of delivery: Cartridge with add-on parts. Please order indexable inserts and accessories separately.

Dimensions in mm.

Compact cartridges

Form T

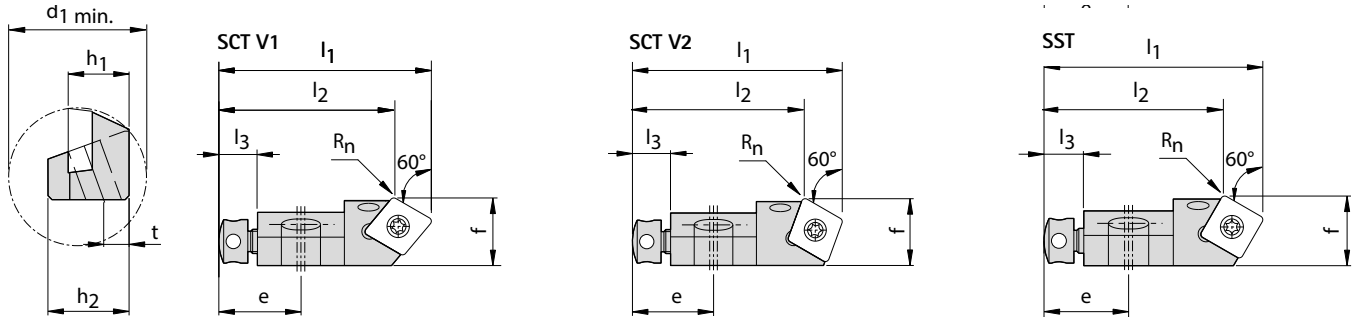

Drawings of right design, example SCTCR.

Preferred series in stock

	Specification	Related indexable insert	Dimensions										Accessory group *	Order no.
			h_1	f (refers to R_n)	R_n	l_1	l_2	e	l_3	h_2	t	$d_1 \text{ min.}$		
SCT...V1	SCTCR 06CK-06 V1	CC_0602__	6	9,7	0,4	25	19,8	11	5	6	2,5	18	9	30011210
	SCTCR 10CK-09 V1	CC_09T3__	10	14	0,8	44	36,5	17	8	15	5	33	14	30011212
SCT...V2	SCTCR 06CK-06 V2	CC_0602__	6	10	0,4	25	19,8	11	5	6	2,5	18	9	30011214
	SCTCR 10CK-09 V2	CC_09T3__	10	14	0,8	44	36,5	17	8	15	5	33	16	30011216
SST...	SSTPR 08CK-06	SP_0603__	8	10	0,4	32	26,9	17	5	10	4,5	24	13	30011218
	SSTCR 10CK-09	SC_09T3__	10	14	0,8	44	36,6	17	8	15	5	33	14	30011220
	SSTCR 12CK-12	SC_1204__	12	18	0,8	50	39,8	20	8	16	5	37	7	30011222
STTCR...	STTCR 06CK-09	TC_0902__	6	10	0,4	25	17,6	11	5	6	2,5	18	17	30011224
	STTCR 10CK-11	TC_1102__	10	14	0,4	40	31,4	17	8	15	5	33	11	30011226
	STTCR 12CK-16	TC_16T3__	12	18	0,8	50	37,5	20	8	16	5	37	12	30011228

* see pages 660-661

Other cutting edge forms, sizes and contact angles available upon request.
 Scope of delivery: Cartridge with add-on parts. Please order indexable inserts and accessories separately.
 Dimensions in mm.

Compact cartridges

Form W, Y

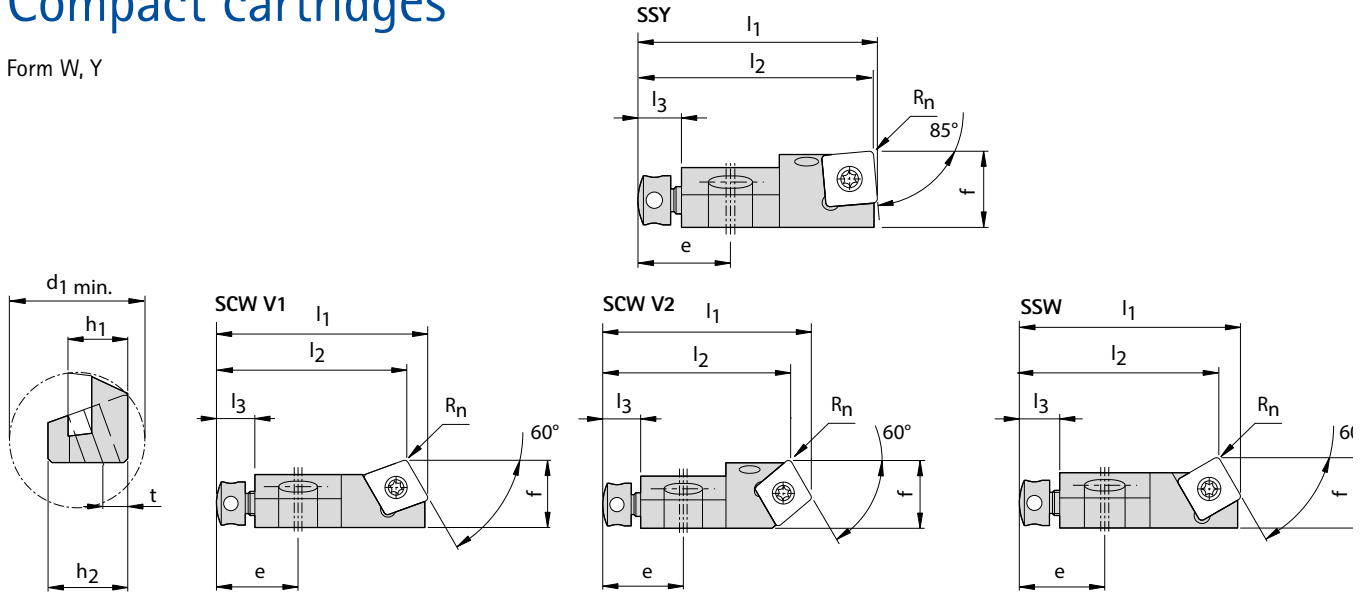

Drawings of right design, example SCWCR.

Preferred series in stock

	Specification	Related indexable insert	Dimensions										Accessory group *	Order no.
			h_1	f (refers to R_n)	R_n	l_1	l_2	e	l_3	h_2	t	$d_1 \text{ min.}$		
SCW...V1	SCWCR 06CK-06 V1	CC__0602__	6	9,7	0,4	25	22	11	5	6	2,5	18	9	30011230
	SCWCR 10CK-09 V1	CC__09T3__	10	14	0,8	44	39,6	17	8	15	5	33	16	30011232
SCW...V2	SCWCL 06CK-06 V2	CC__0602__	6	10	0,4	25	22	11	5	6	2,5	18	9	30011235
SSW...	SSWPR 08CK-06	SP__0603__	8	10	0,4	32	29,1	17	5	10	4,5	24	13	30011238
	SSWCL 10CK-09	SC__09T3__	10	14	0,8	44	39,7	17	8	15	5	33	16	30011241
	SSWCR 12CK-12	SC__1204__	12	18	0,8	50	44,1	20	8	16	5	37	7	30011242
	SSWCL 12CK-12	SC__1204__	12	18	0,8	50	44,1	20	8	16	5	37	7	30011243
SSY...	SSYPR 08CK-06	SP__0603__	8	10	0,4	32	31,5	17	5	10	4,5	24	13	30011250
	SSYCR 10CK-09	SC__09T3__	10	14	0,8	44	43,2	17	8	15	5	33	16	30011252
	SSYCL 10CK-09	SC__09T3__	10	14	0,8	44	43,2	17	8	15	5	33	16	30011253
	SSYCR 12CK-12	SC__1204__	12	18	0,8	50	49	20	8	16	5	37	7	30011254

* see pages 660-661

Other cutting edge forms, sizes and contact angles available upon request.
 Scope of delivery: Cartridge with add-on parts. Please order indexable inserts and accessories separately.
 Dimensions in mm.

Compact cartridges for tangential indexable inserts

Form F

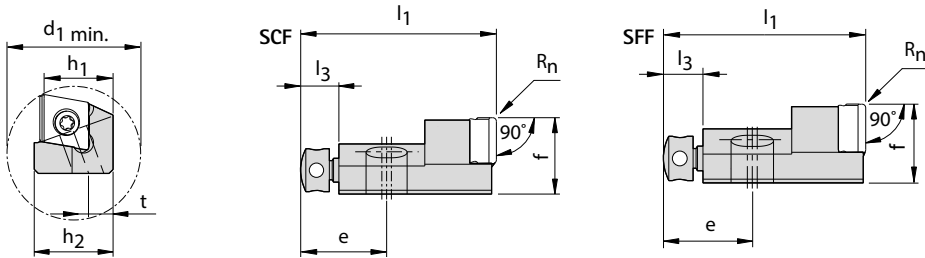

Drawings of right design, example SCFNR.

Preferred series in stock

	Specification	Related indexable insert	Dimensions										Accessory group *	Order no.
			h_1	f (refers to R_n)	R_n	l_1	l_2	e	l_3	h_2	t	$d_1 \text{ min.}$		
SCF...	SCFNR 10CT-06	CTHQ0604__	10	11	0,8	29	-	12	5	10,5	5	40	22	30305015
	SCFNR 14CT-09	CTHQ0905__	14	16	0,8	41	-	18	8	16	7	65	24	30305018
	SCFNR 18CT-12	CTHQ1206__	18	22	0,8	43	-	18	8	20	7	75	26	30305020
	SCFDR 10 CT-06	CTHD0603__	10	11	0,8	29	-	12	5	10,5	5	40	22	30552260
	SCFDR 14 CT-09	CTHD09T3__	14	16	0,8	41	-	18	8	16	7	65	20	30552263
	SCFDR 18 CT-12	CTHD1204__	18	22	0,8	43	-	18	8	20	7	75	18	30552264
SFF...	SFFNR 10CT-06	FTHQ0604__	10	11	0,8	29	-	12	5	10,5	5	35	22	30305022
	SFFNR 14CT-09	FTHQ0905__	14	16	0,8	41	-	18	8	16	7	44	24	30305024
	SFFNR 18CT-12	FTHQ1206__	18	22	0,8	43	-	18	8	20	7	59,5	26	30305026

* see pages 660-661

Compact cartridges for tangential indexable inserts

Form 80, W

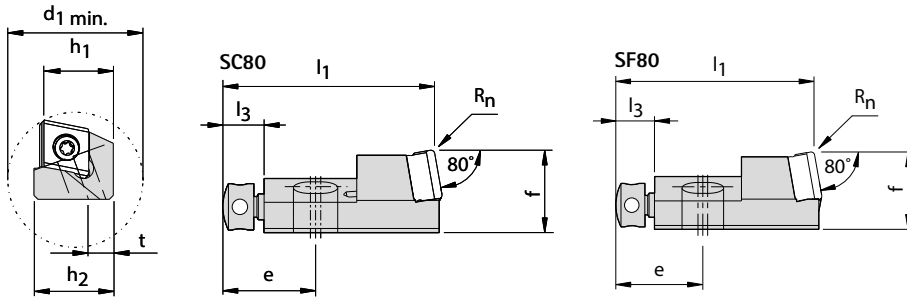

Drawings of right design, example SC80NR.

Preferred series in stock

	Specification	Related indexable insert	Dimensions										Accessory group *	Order no.
			h_1	f (refers to R_n)	R_n	l_1	l_2	e	l_3	h_2	t	$d_1 \text{ min.}$		
SC80...	SC80NR 10CT-06	CTHQ0604__	10	11	0,8	29	-	12	5	10,5	5	40	23	30305016
	SC80NR 14CT-09	CTHQ0905__	14	16	0,8	41	-	18	8	16	7	65	25	30305019
	SC80NR 18CT-12	CTHQ1206__	18	22	0,8	43	-	18	8	20	7	75	27	30305021
SF80...	SF80NR 10CT-06	FTHQ0604__	10	11	0,8	29	-	12	5	10,5	5	35	23	30305023
	SF80NR 14CT-09	FTHQ0905__	14	16	0,8	41	-	18	8	16	7	44	25	30305025
	SF80NR 18CT-12	FTHQ1206__	18	22	0,8	43	-	18	8	20	7	59,5	27	30305027

* see pages 660-661

Other cutting edge forms, sizes and contact angles available upon request.

Scope of delivery: Cartridge with add-on parts. Please order indexable inserts and accessories separately.

Dimensions in mm.

Compact cartridges for tangential indexable inserts

Form S, T, R

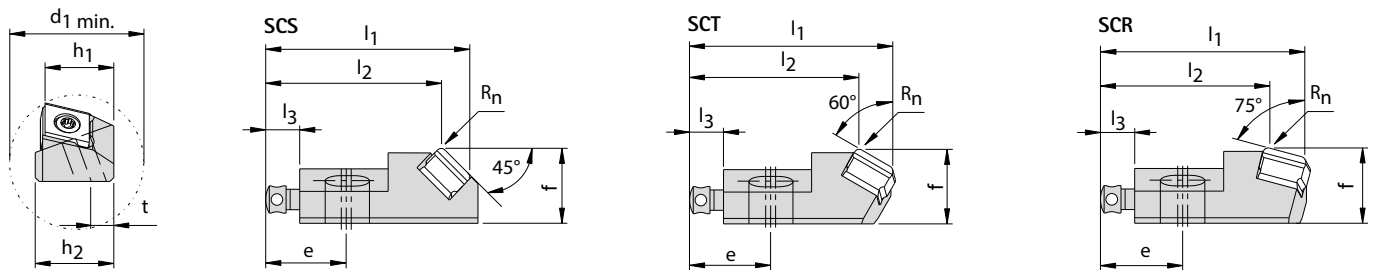

Drawings of right design, example SCSNR.

Preferred series in stock

Specification	Related indexable insert	Dimensions											Accessory group *	Order no.
		h_1	f (refers to R_n)	R_n	l_1	l_2	e	l_3	h_2	t	$d_1 \text{ min.}$			
SCS... SCSNR 14 CT-09	CTHQ0905__	14	16	0,8	42,5	36	18	8	16	7	65	30	30552283	
SCT... SCTNR 10 CT-06	CTHQ0604__	10	11	0,8	30	24,7	12	5	10,5	5	40	22	30552284	
	SCTNR 14 CT-09	CTHQ0905__	14	16	0,8	42,5	34,4	18	8	16	7	65	20	30552285
	SCTDR 10 CT-06	CTHD0603__	10	11	0,8	30	24,7	12	5	10,5	5	40	22	30552274
SCR... SCRNR 14 CT-09	CTHQ0905__	14	16	0,8	42,5	33,3	18	8	16	7	65	20	30552287	

* see pages 660-661

Compact cartridges for tangential indexable inserts

Form W, S, T, 20, R

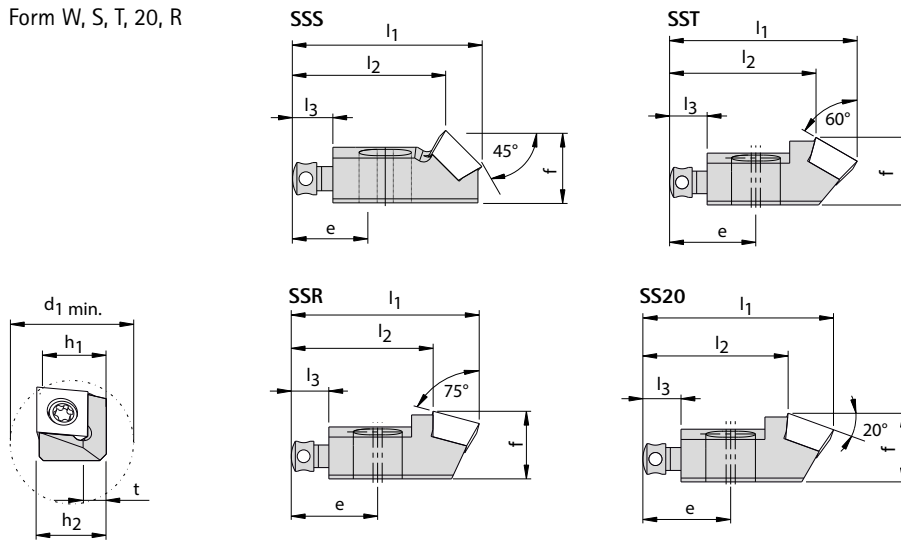

Drawings of right design, example SSSDR.

Preferred series in stock

	Specification	Related indexable insert	Dimensions									Accessory group *	Order no.
			h_1	f	l_1	l_2	e	l_3	h_2	t	$d_{1 \text{ min.}}$		
SSS...	SSSDR 08CT-06	STHD0603__	8,5	9	23,5	19	11,5	5	8,2	3,2	33	28	30474905
	SSSDR 14CT-09	STHD09T3__	14	13,5	35,7	29	18	8	13,5	5	50	32	30474906
SST...	SSTDR 08 CT-06	STHD0603__	8,5	9	25	19,5	11,5	5	8,2	3,2	33	28	30552292
	SSTDR 14 CT-09	STHD09T3__	14	13,5	38	29,8	18	8	13,5	5	50	32	30552293
SS20...	SS20DR 08 CT-06	STHD0603__	8,5	9	25	19	11,5	5	8,2	3,2	33	28	30552294
	SS20DR 14 CT-09	STHD09T3__	14	13,5	38	29	18	8	13,5	5	50	32	30552295
SSR...	SSRDR 08 CT-06	STHD0603__	8,2	9	25	18,9	11,5	5	8,2	3,2	33	28	30552288
	SSRDR 14 CT-09	STHD09T3__	14	13,5	38	28,8	18	8	13,5	5	50	32	30552289

* see pages 660-661

Other cutting edge forms, sizes and contact angles available upon request.

Scope of delivery: Cartridge with add-on parts. Please order indexable inserts and accessories separately.

Dimensions in mm.

Accessories for ISO cartridges and compact cartridges

Radial and tangential design



Accessory group	Fastening screw for cartridge			Axial adjusting screw		Radial adjusting screw		
	Cylinder head screw product code	Tightening torque [Nm]	Order no.	Capstan screw product code	Order no.	Threaded pin product code	Order no.	
ISO cartridges	1	DIN 7984 M6x20-10.9	12	10019671	M5 x 10	10029150	DIN 913 M4x10-45H	10003433
	2	DIN 7984 M4x12-10.9	3	10019695	M3 x 8	10002641	DIN 913 M3x6-45H	10003422
	3	DIN 7984 M4x12-10.9	3	10019695	M3 x 8	10002641	DIN 913 M3x6-45H	10003422
	4	DIN 7984 M6x16-10.9	12	10019703	M5 x 10	10029150	DIN 913 M4x8-45H	10003432
	5	DIN 7984 M6x16-10.9	12	10019703	M5 x 10	10029150	DIN 913 M4x8-45H	10003432
	6	DIN 7984 M6x20-10.9	12	10019671	M5 x 10	10029150	DIN 913 M4x10-45H	10003433
Compact cartridges	7	MN685 M6x25-TX25-IP	12	30606074	M5 x 7	10018493	DIN 915 M4x10-45H	10003900
	8	MN685 M6x25-TX25-IP	12	30606074	M5 x 7	10018493	DIN 915 M4x10-45H	10003900
	9	MN685 M3x10-TX9-IP	1.8	30606065	M3 x 5	10025039	DIN 915 M3x6-45H	10003894
	10	MN685 M3x10-TX9-IP	1.8	30606065	M3 x 5	10025039	DIN 915 M3x6-45H	10003894
	11	MN685 M6x20-TX25-IP	12	30606068	M5 x 7	10018493	DIN 915 M4x10-45H	10003900
	12	MN685 M6x25-TX25-IP	12	30606074	M5 x 7	10018493	DIN 915 M4x10-45H	10003900
	13	MN685 M4x14-TX15-IP	3	30606067	M3 x 5	10025039	DIN 915 M3x6-45H	10003894
	14	MN685 M6x20-TX25-IP	12	30606068	M5 x 7	10018493	DIN 915 M4x10-45H	10003900
	15	MN685 M6x20-TX25-IP	12	30606068	M5 x 7	10018493	DIN 915 M4x10-45H	10003900
	16	MN685 M6x20-TX25-IP	12	30606068	M5 x 7	10018493	DIN 915 M4x10-45H	10003900
	17	MN685 M3x10-TX9-IP	1.8	30606065	M3 x 5	10025039	DIN 915 M3x6-45H	10003894
Tangential compact cartridges	18	ISO 4762-M6X25-12.9	12	10003620	M5 x 7	10018493	ISO 4028-M4x10-45H-KL	30351530
	19	ISO 4762-M6X25-12.9	12	10003620	M5 x 7	10018493	ISO 4028-M4x10-45H-KL	30351530
	20	DIN 7984-M6X20-10.9	12	10019671	M5 x 7	10018493	ISO 4028-M4x10-45H-KL	30351530
	21	DIN 7984-M6X20-10.9	12	10019671	M5 x 7	10018493	ISO 4028-M4x10-45H-KL	30351530
	22	DIN 7984-M4X16-10.9	3	10019685	M3 x 5	10025039	ISO 4028-M3x6-45H-KL	30351529
	23	DIN 7984-M4X16-10.9	3	10019685	M3 x 5	10025039	ISO 4028-M3x6-45H-KL	30351529
	24	DIN 7984-M6X20-10.9	12	10019671	M5 x 7	10018493	ISO 4028-M4x10-45H-KL	30351530
	25	DIN 7984-M6X20-10.9	12	10019671	M5 x 7	10018493	ISO 4028-M4x10-45H-KL	30351530
	26	ISO 4762-M6X25-12.9	12	10003620	M5 x 7	10018493	ISO 4028-M4x10-45H-KL	30351530
	27	ISO 4762-M6X25-12.9	12	10003620	M5 x 7	10018493	ISO 4028-M4x10-45H-KL	30351530
	28	MN685 M4x14-TX15-IP	3	30606067	M3 x 5	10025039	-	-
	29	ISO 4762-M6X25-12.9	12	10003620	M5 x 7	10018493	-	-
	30	DIN 7984-M6X20-10.9	12	10019671	M5 x 7	10018493	ISO 4028-M4x10-45H-KL	30351530
	31	DIN 7984-M4X16-10.9	3	10019685	M3 x 5	10025039	ISO 4028-M3x6-45H-KL	30351529
	32	MN685 M6x20-TX25-IP	12	30606068	M5 x 7	10018493	-	-

* Tightening torques according to MN678

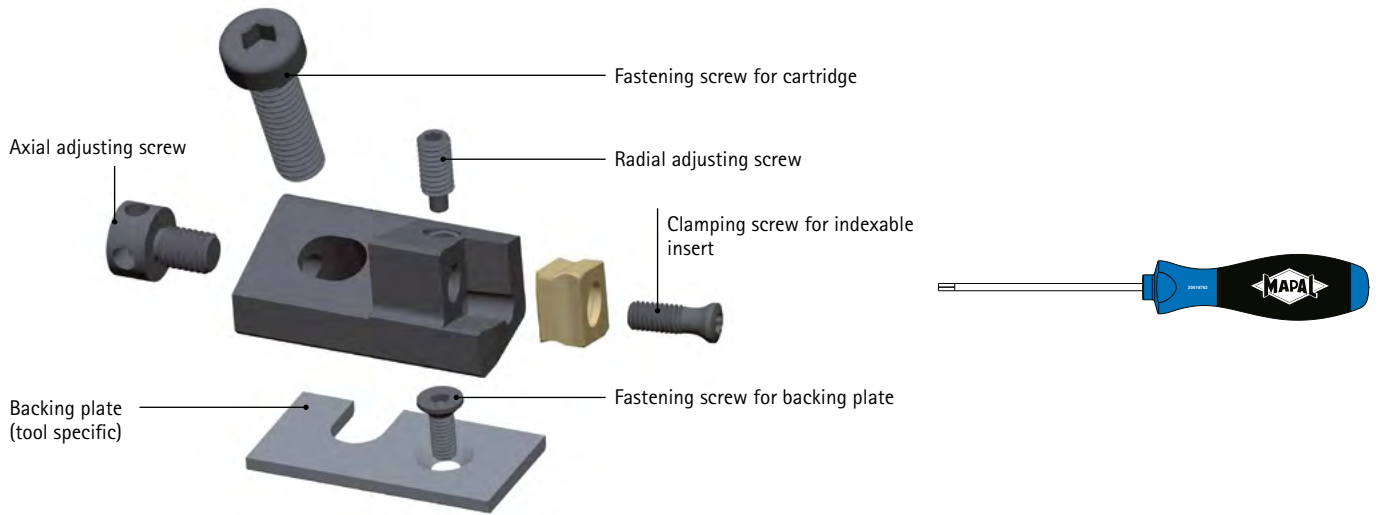

	Backing plate right		Backing plate left		Fastening screw for backing plate		
	Backing plate product code	Order no.	Backing plate product code	Order no.	Countersunk screw product code	Tightening torque [Nm]	Order no.
	UR 12-1A	available upon request	UL 12-1A	available upon request	ISO 10642-M3X8-10.9	1.8	10003769
	UR 08-1A	available upon request	UL 08-1A	available upon request	ISO 10642-M3X6-10.9	1.8	10003768
	UR 08-1A	available upon request	UL 08-1A	available upon request	ISO 10642-M3X6-10.9	1.8	10003768
	UR 10-1A	available upon request	UL 10-1A	available upon request	ISO 10642-M3X8-10.9	1.8	10003769
	UR 10-1A	available upon request	UL 10-1A	available upon request	ISO 10642-M3X8-10.9	1.8	10003769
	UR 12-1A	available upon request	UL 12-1A	available upon request	ISO 10642-M3X8-10.9	1.8	10003769
	UR 12-1K	available upon request	UL 12-1K	available upon request	ISO 10642-M3X8-10.9	1.8	10003769
	UR 12-2K	available upon request	UL 12-2K	available upon request	ISO 10642-M3X8-10.9	1.8	10003769
	UR 06-1K	available upon request	UL 06-1K	available upon request	ISO 2009-M2X4-4.8	0.5	10029153
	UR 06-2K	available upon request	UL 06-2K	available upon request	ISO 2009-M2X4-4.8	0.5	10029153
	UR 10-1K	available upon request	UL101K	available upon request	ISO 10642-M3X8-10.9	1.8	10003769
	UR 12-1K	available upon request	UL 12-1K	available upon request	ISO 10642-M3X8-10.9	1.8	10003769
	UR 08-1K	available upon request	UL 08-1K	available upon request	ISO 10642-M3X6-10.9	1.8	10003768
	UR 10-1K	available upon request	UL 10-1K	available upon request	ISO 10642-M3X8-10.9	1.8	10003769
	UR 10-2K	available upon request	UL 10-2K	available upon request	ISO 10642-M3X8-10.9	1.8	10003769
	UR 10-3K	available upon request	UL 10-3K	available upon request	ISO 10642-M3X8-10.9	1.8	10003769
	UR 06-1K	available upon request	UL 06-1K	available upon request	ISO 2009-M2X4-4.8	0.5	10029153
	UR 18-1T	available upon request	-	-	ISO 10642-M3X8-10.9	1.8	10003769
	UR 18-4T	available upon request	-	-	ISO 10642-M3X8-10.9	1.8	10003769
	UR 14-1T	available upon request	-	-	ISO 10642-M3X8-10.9	1.8	10003769
	UR 14-4T	available upon request	-	-	ISO 10642-M3X8-10.9	1.8	10003769
	UR 10-1T	available upon request	-	-	ISO 10642-M3X8-10.9	1.8	10003769
	UR 10-2T	available upon request	-	-	ISO 10642-M3X8-10.9	1.8	10003769
	UR 14-2T	available upon request	-	-	ISO 10642-M3X8-10.9	1.8	10003769
	UR 14-3T	available upon request	-	-	ISO 10642-M3X8-10.9	1.8	10003769
	UR 18-2T	available upon request	-	-	ISO 10642-M3X8-10.9	1.8	10003769
	UR 18-3T	available upon request	-	-	ISO 10642-M3X8-10.9	1.8	10003769
	-	-	-	-	-	-	-
	-	-	-	-	-	-	-
	UR 14-5T	available upon request	-	-	ISO 10642-M3X8-10.9	1.8	10003769
	UR 10-3T	available upon request	-	-	ISO 10642-M3X8-10.9	1.8	10003769
	-	-	-	-	-	-	-

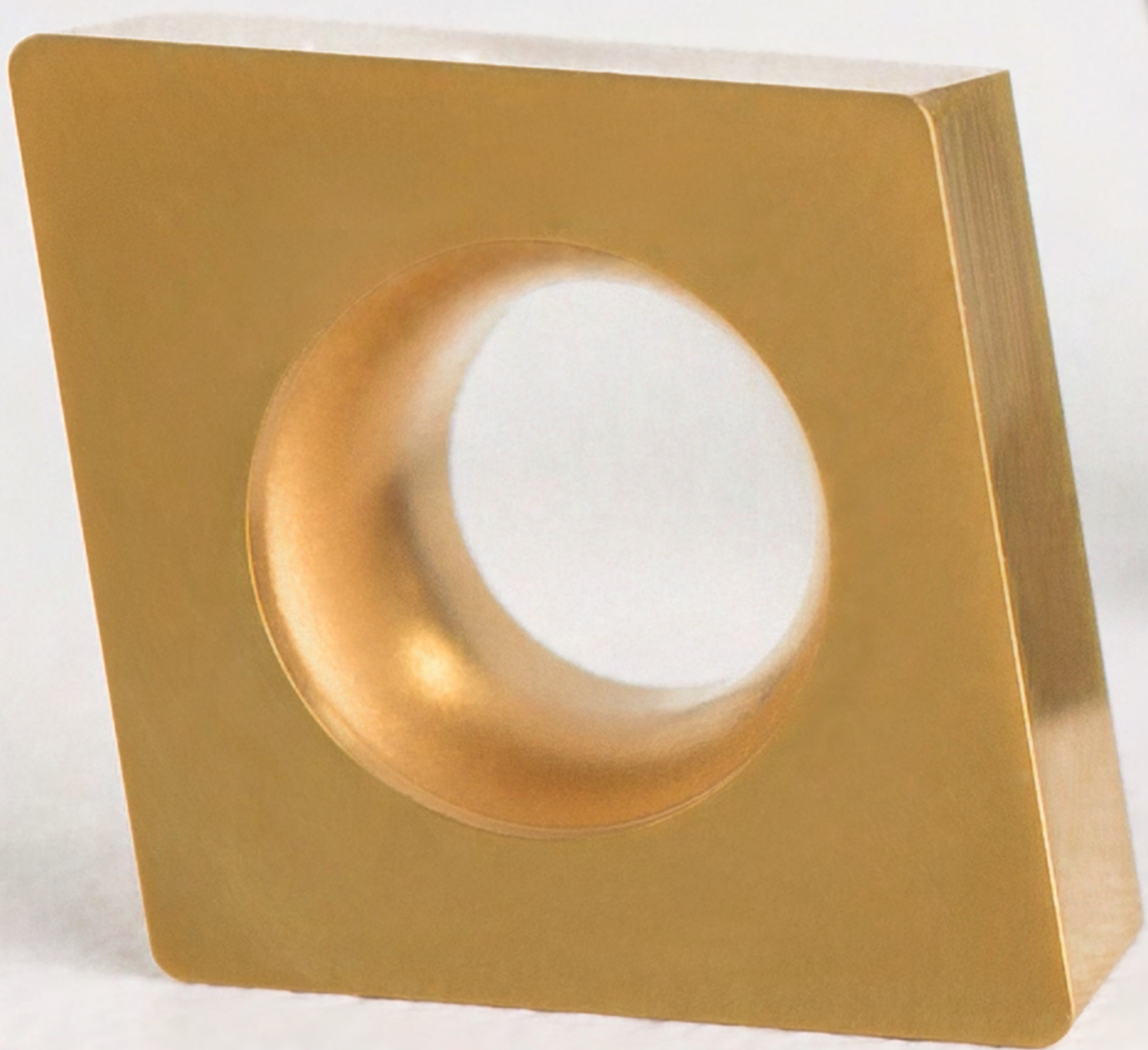

INDEXABLE INSERTS

Introduction

Cutting material	664
Product overview	666
Cutting material overview	670
Product ID codes	676
Overview of chip guiding stages	680

Indexable inserts

Radial indexable inserts	686
Tangential indexable inserts	708
Accessories	730

Technical appendix

Cutting data recommendations	732
------------------------------------	-----

Cutting material series – the right cutting material for every application

MAPAL offers a wide range of radial and tangential indexable inserts that covers all requirements for different cutting materials and coatings as well as the related cutting edge geometries and accuracies.

Performance Line cutting material series

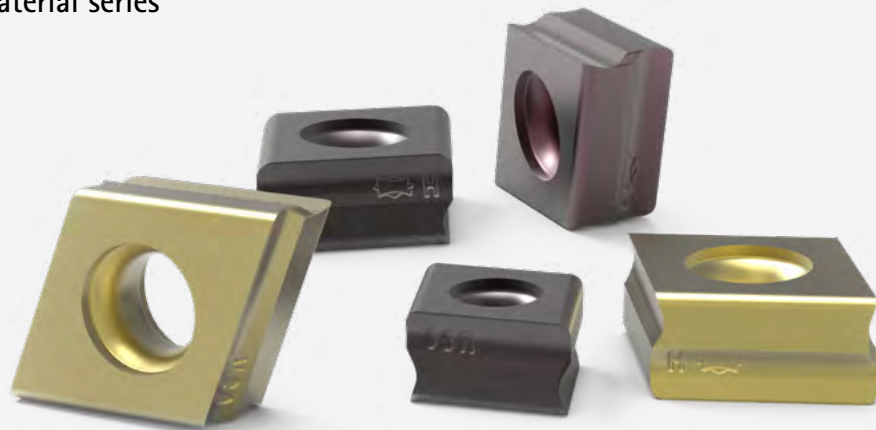

The cutting material series of the Performance Line offers a wide range of radial and tangential indexable inserts that covers all requirements for different cutting materials and coatings as well as the related cutting edge geometries and accuracies.

The high-precision, ground indexable inserts from tolerance class H are truly multi-cutting-edge capable even with fixed cutting edges. This is because, in conjunction with precisely manufactured insert seats, the cutting edges show only minimal deviations from each other. This means that all cutting edges are in use at the same time during machining. As a result, considerable increases in performance are possible.

Sintered tangential indexable inserts in tolerance class N add particularly cost-effective alternatives to the range, especially for machining with larger permissible tolerances. New to the range are the circumferentially ground radial and tangential indexable insert of tolerance class G, which represent a cost-effective alternative to the high-precision indexable inserts.

AT A GLANCE

- Wide range of radial and tangential indexable inserts.
- The range extends from ground, high-precision inserts in tolerance class H to sintered inserts in tolerance class N and G
- Large selection of cutting materials for almost every application area
- Tipped variants with PCD and PcBN for highly economical machining of machining of aluminium and cast iron

Marking on "press-to-size" indexable inserts

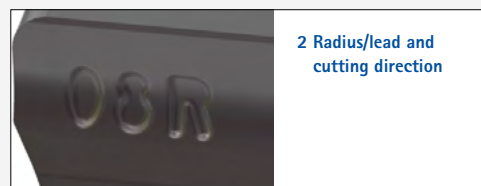

Basic Line cutting material series

P M K

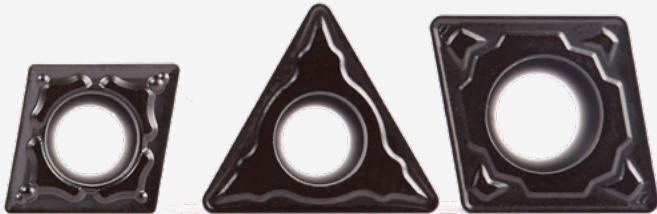

The Basic Line series of positive radial inserts for boring and turning impresses due to an excellent price/performance ratio. For machining cast iron, steel and stainless steel, CVD- and PVD-coated cutting materials are available that cover a wide range, whether wear resistant or ductile. So it is possible to select the optimal indexable insert for every application. Depending on the machining, different basic shapes are available with different chip guiding stages in the tolerance classes M and G for roughing, medium machining and finishing.

AT A GLANCE

- Positive radial inserts for boring and turning
- Excellent price-performance ratio
- CVD- and PVD-coated cutting materials for P, M and K workpiece material
- Cermet cutting edges for high surface finish in steel
- Different chip guiding stages for roughing, medium machining and finishing

Cutting material series for mixed machining

N + K N + P

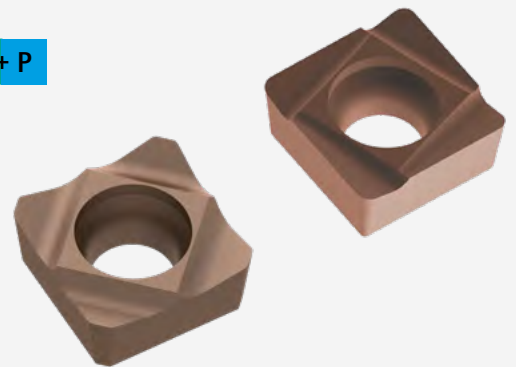

Material combinations of aluminium and sintered steel or aluminium and cast iron, such as those used in the manufacturing of the crankcase, place special demands on machining. MAPAL offers a specially adapted cutting material series for such machining operations. Both their carbide substrates and the micro and macro geometries of the cutting edges were specially developed for mixed machining.

A PVD coating as part of the cutting material series prevents both a built-up edge during aluminium machining and excessive wear during machining of the cast iron or sintered steel portion of the workpiece. This is because it ensures that the cutting material is particularly wear-and-tear and heat resistant. In this way, machining can be carried out in the highest quality.

AT A GLANCE

- Cutting material for the machining of the material combinations aluminium and cast iron as well as aluminium and sintered steel
- Modified carbide substrate, optimised micro and macro geometries on the insert, PVD coating based on TiAlN alloy with special dopant
- Standard and custom ISO indexable inserts available
- Long tool life and therefore high economic efficiency

Product overview for indexable inserts 1/2

Radial technology

Insert type	Radial technology – Basic Line							
	CCMT	CCGT	DCMT	SCMT SPMT	SCGT	TCMT	VCMT	VCGT
								

Features

Number of cutting edges	2	2	2	4	4	3	2	2
Insert size	06 / 09 / 12	06 / 09 / 12	07 / 11 / 15	06 / 09 / 12	09	09 / 11 / 16 / 22	16	11
Diameter range	from 17 mm	from 17 mm		from 17 mm	from 25 mm	from 17 mm		
Cutting direction	N	N	N	N	N	N	N	N
Boring – neutral	■	■	■	■	■	■	■	■
Boring – arc shaped land								
Countersinking / chamfering								

Application

Roughing	■		■	■		■	■	
Medium machining	■	■	■	■		■	■	■
Finishing	■	■	■	■	■	■		

Cutting material

Ground carbide		■						■
Pressed carbide	■		■	■		■	■	
Cermet		■	■		■	■	■	
PcBN								
PCD								

Material suitability









P	■	■	■	■	■	■	■	■
M ₁	■	■	■	■		■		■
M ₂	■	■	■	■		■		■
K	■		■	■		■	■	
N								
N K								
N P								

Page	686	688	692	694	694	700	704	704
------	-----	-----	-----	-----	-----	-----	-----	-----

* With favourable installation situation



Stainless steel

Heat-resistant cast steel (turbocharger materials)

Radial technology – Performance Line									
CCGW	CCHT	CCHT	SCGW SPGW	SCHT SPHT	SCHT SPHT	SCHT	TCHT	TCHT	
									
2	2	2	4	4	2	4	3	1	
06 / 09	06 / 09 / 12	09	06 / 09 / 12	06 / 09 / 12	06 / 09 / 12	09	06 / 09 / 11 / 16	06 / 09 / 11 / 16	
from 17 mm	from 17 mm	from 24 mm	from 17 mm	from 17 mm	from 17 mm	from 25 mm	from 15 mm	from 15 mm	
N	L / R	L / R	N	L / R	X	L / R	L / R	X	
■	■	■	■	■	■	■	■	■	
■	■	■	■	■	■	■	■	■	■
■	■		■	■	■	■	■	■	■
		■				■			
		■				■			■
689	690	706	696	698	697	707	702	703	

Product overview for indexable inserts 2/2

Tangential technology

Insert type	Radial technology – Performance Line							
	CCGT	CCGW	DCGT	DCGW	SCGT SPGT	SCGW SPGW	TCGW	VBGW VCGW
								

Features

Number of cutting edges	1	1	1	1	1	1	1	1
Insert size	06 / 09	06 / 09	11	11	06 / 09	06 / 09 / 12	11	16
Diameter range	from 17 mm	from 17 mm			from 17 mm	from 17 mm	from 17 mm	
Cutting direction	N	N	N	N	L / R / N	N	N	N
Neutral – boring	■	■	■	■	■	■	■	■
Boring – arc shaped land								
Countersinking / chamfering								

Application

Roughing								
Medium machining	■	■	■			■	■	
Finishing	■	■	■	■	■	■	■	■









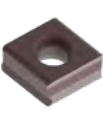

Cutting material

Ground carbide								
Pressed carbide								
Cermet								
PcBN		■		■		■	■	■
PCD	■	■	■	■	■	■	■	

Material suitability

P								
M ₁								
M ₂								
K		■		■		■	■	■
N	■	■	■	■	■	■	■	
N K								
N P								

Page	688	689	692	692	694	696	700	704
------	-----	-----	-----	-----	-----	-----	-----	-----

Tangential technology – Performance Line									
CTNQ	CTGQ	CTHQ		FTNQ	FTGQ	FTHQ		STHD / STHE	
									
4	4	4	1	4	4	4	1	4	1
09 / 12	09 / 12	06 / 09 / 12	06 / 09 / 12	09 / 12	09 / 12	06 / 09 / 12	06 / 09 / 12	06 / 09	06 / 09
from 41 mm	from 65 mm	from 28 mm	from 28 mm	from 30 mm	from 30 mm	from 22 mm	from 22 mm		
L / R	L	L / R	L / R	L / R	L	L / R	L / R	N	N
■		■	■	■		■	■		
	■	■	■		■	■	■		
								■	■
■	■	■	■	■	■	■	■		
■	■	■	■	■	■	■	■		
■		■			■	■		■	
	■			■					
			■				■		■
■	■	■		■	■	■			
■	■	■		■		■			
■	■	■		■		■		■	
■		■		■	■	■		■	
		■	■			■	■	■	■
708	710	712	712	718	720	722	722	728	728

Cutting material overview: Selection of the correct cutting material

Selection of cutting material

A wide spectrum of cutting material is available, whether wear resistant or ductile. The designation of the cutting material indicates the level of ductility; the ductility increases as the number increases.

CVD-coated cutting materials (HC...) are the first choice for boring K, P and M workpiece materials. This achieves the longest tool life.

Example: HC830 is more ductile than HC815 (the more ductile the cutting material, the less resistant it is to wear).

For non-ferrous workpiece materials, uncoated and PCD-coated carbide types (HU.../HP...) are the first choice. From a silicon content of ≥12%, PCD (PU...) is recommended due to increasing abrasiveness. With PCD, the longest tool life can be achieved, which is why this cutting material is particularly suitable for large series.

1. Select your workpiece material according to the MMG (MAPAL machining groups, see fold-out page on inside cover).

2. Depending on the product line, select the type below the desired workpiece material from the corresponding **"Cutting material overview [...]"** table.

3. Depending on the general conditions (see **"General conditions" table**), a wear-resistant or rather ductile CVD-coated cutting material should be selected.

4. If general conditions in the direction of the black arrow predominate and breakages cannot be prevented despite a ductile CVD grade, you should change to PVD-coated cutting materials.

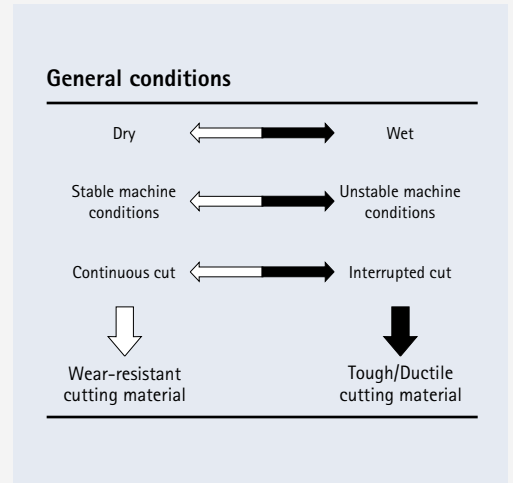

Basic Line cutting material overview

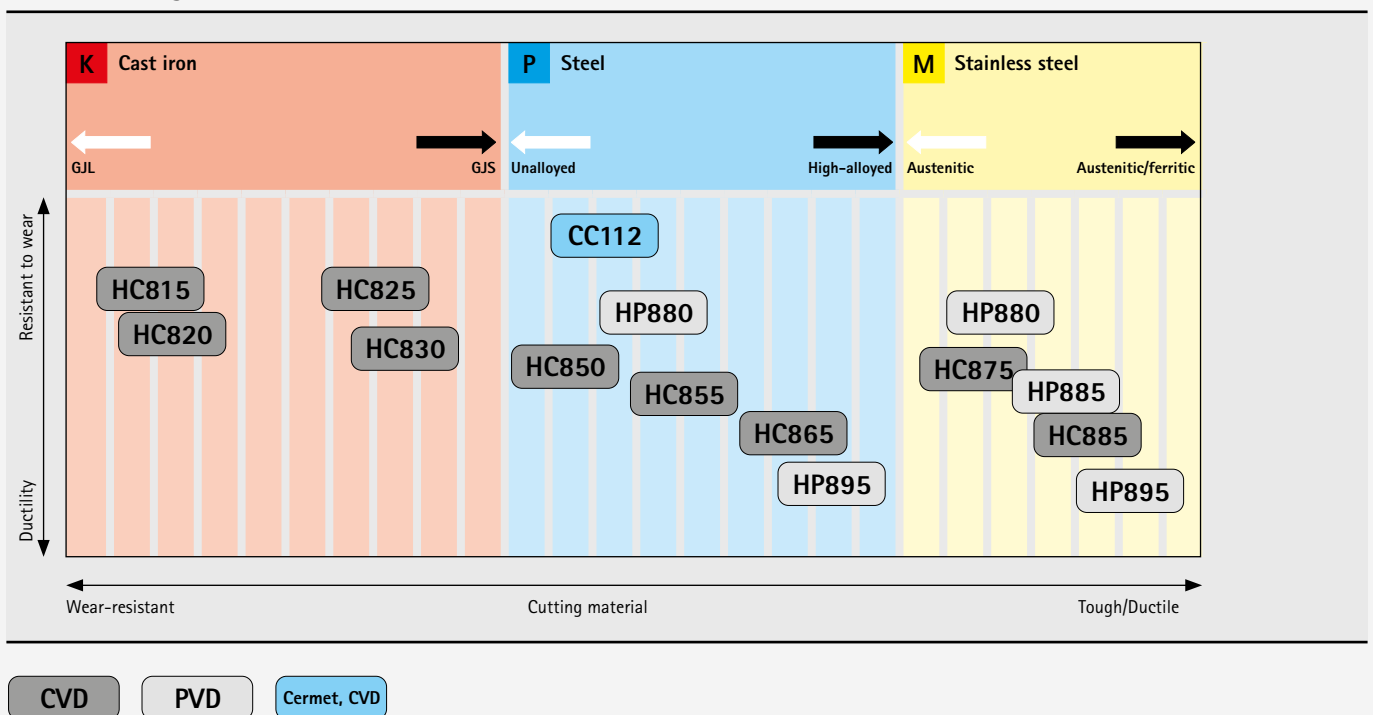

Selection of cutting material

1. Select the material type below the desired workpiece material in the "Cutting material overview" table.
2. For the mixed machining of aluminium-cast-iron, the grade HP530-P is the first choice, for aluminium-steel the grade HP545-P.
3. If a stable process is ensured with normal wear and tear, a wear-resistant grade (HP525-P for aluminium-cast-iron or HP540-P for aluminium-steel) can be selected for improved tool life.

Cutting material overview for mixed machining

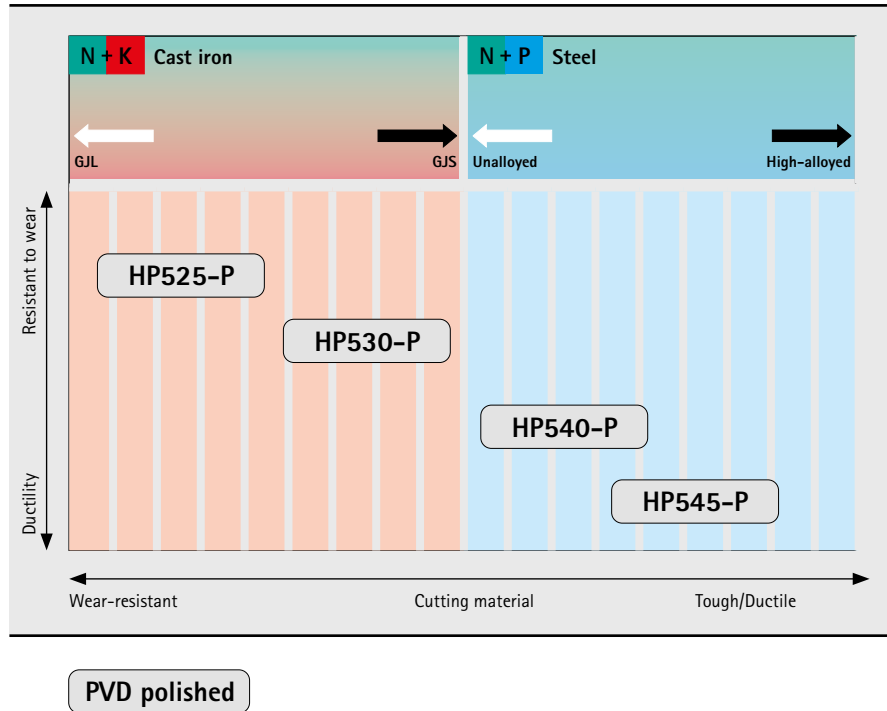

Performance Line cutting material overview

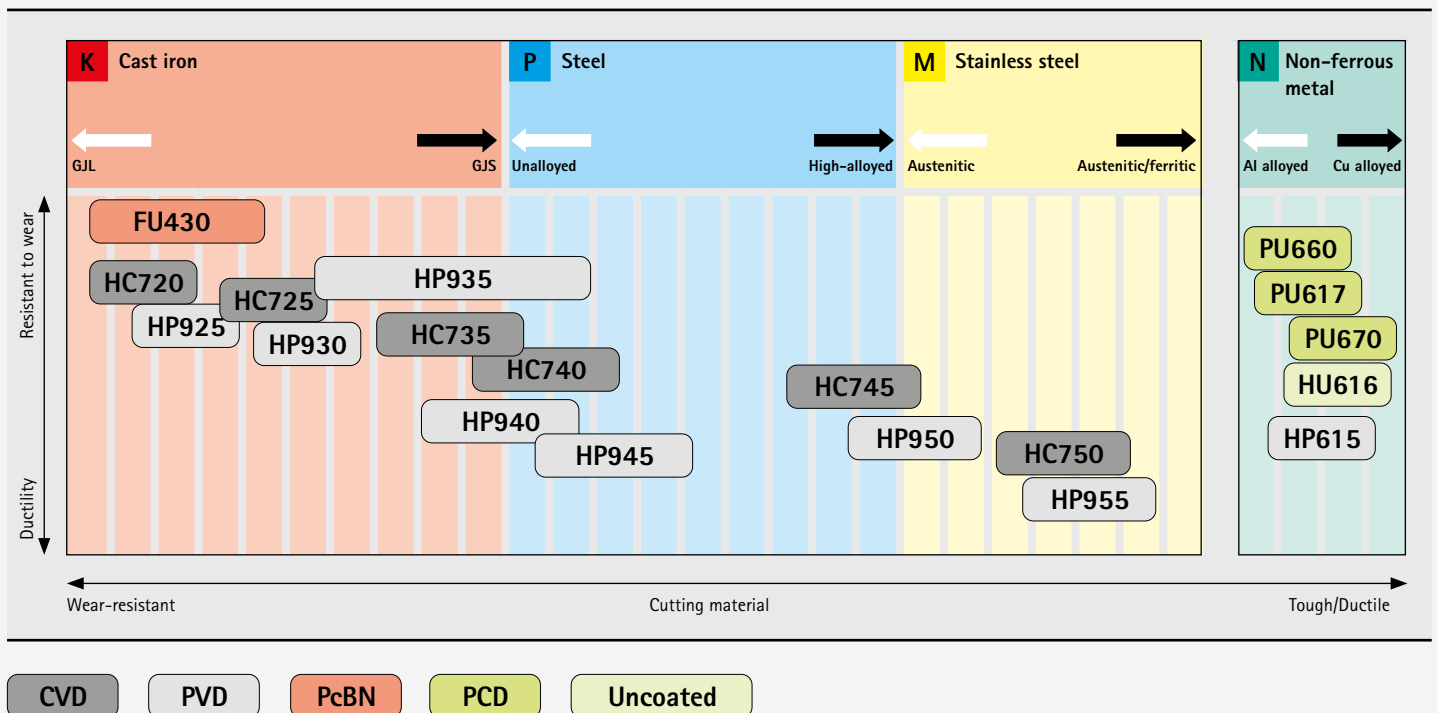

Cutting material overview: Types and type description 1/2

Substrate	Coating	Cutting material	Coating composition	Colour of coating	Field of application	Recommended application
Cermet	CVD-coated	CC112	TiCN+Al ₂ O ₃	Multi-coloured	●	Finest grain cermet grade with Al ₂ O ₃ coating for finishing and semi-machining steel and cast iron materials with elevated cutting speeds.
PcBN	Un-coated	FU430	-	-	●	PcBN grade with high CBN content for finishing and semi-finishing GJL and sintered metal.
Carbide	CVD-coated	HC698*	Diamond	Black anthracite	●	Carbide with CVD diamond coating for machining aluminium.
		HC725	TiCN+Al ₂ O ₃	Black	●	Fine-grain carbide with high wear resistance and a multi-layer CVD coating with Al ₂ O ₃ top coating for machining GJL and GJS at high cutting speeds. For smooth to slightly interrupted cut for medium machining to roughing.
		HC740	TiCN+Al ₂ O ₃	Black	●	Fine-grain carbide with high wear resistance and a multi-layer CVD coating with Al ₂ O ₃ top coating. For smooth to slightly interrupted cut for medium machining to roughing in GJS, non-alloy steels as well as heat-resistant cast steel.
		HC745	TiCN+Al ₂ O ₃	Black	⚡	Fine grain carbide with a balanced proportion of wear-and-tear and ductility and a multi-layer CVD coating with Al ₂ O ₃ top coating for machining at higher cutting speeds. For interrupted cut or unstable conditions and workpiece materials with increased tensile strength, from high-alloy steels to stainless steels as well as heat-resistant cast steel.
		HC750	TiCN+Al ₂ O ₃	Black	⚡	Fine grain carbide with a balanced amount of ductility and a multi-layer CVD coating with Al ₂ O ₃ top coating. For interrupted cut or unstable conditions and workpiece materials with highest tensile strength, from stainless steels to heat-resistant steel castings.
		HC815	TiCN+Al ₂ O ₃	Black	●	Wear-resistant fine-grain carbide grade with Al ₂ O ₃ coating. Suitable for machining cast iron materials in stable conditions.
		HC820	TiCN+Al ₂ O ₃	Black	●	Al ₂ O ₃ -coated carbide with optimised post-treatment to increase edge stability. Suitable for machining GJL in stable conditions and with slightly interrupted cut.
		HC825	TiCN+Al ₂ O ₃	Black	●	Increased wear resistance due to thicker CVD coating. Suitable for machining cast iron in unstable conditions.
		HC830	TiCN+Al ₂ O ₃	Black	●	Fine-grain carbide grade with thick coating and improved edge stability. Suitable for heavily interrupted cut in cast iron.
		HC850	TiCN+Al ₂ O ₃ +TiN	Gold	●	Gradient carbide with MT-TiCN and Al ₂ O ₃ coating and TiN surface layer. Suitable for machining steel due to reduced surface roughness.
		HC855	TiCN+Al ₂ O ₃ +TiN	Gold	●	Gradient carbide with balanced proportion of ductility and wear resistance. Suitable for semi-finishing and for medium machining of steel.
		HC865	TiCN+Al ₂ O ₃ +TiN	Gold	⚡	Ductile gradient carbide grade with Al ₂ O ₃ coating and smooth TiN surface layer. Suitable for semi-finishing and for medium machining of steel and alloyed steel.
		HC875	TiCN+Al ₂ O ₃ +TiN	Gold	●	Fine grain gradient carbide grade with thin CVD coating. Suitable for machining high-alloy steel and stainless steel.
		HC885	TiCN+Al ₂ O ₃ +TiN	Gold	⚡	Carbide grade with increased ductility and CVD coating. Suitable for machining stainless steel.

* Cutting material for drilling aluminium from solid.

Cutting material overview: Types and type description 2/2







Substrate	Coating	Cutting material	Coating composition	Colour of coating	Field of application	Recommended application	
Carbide	PVD-coated	HP615	TiB2	Anthracite	●	Fine grain carbide with a partially reduced PVD coating for machining adhesive materials. First choice for increasing tool life compared to uncoated cutting edges in aluminium alloys with 7-12 per cent silicon.	
		HP880	TiAlN	Anthracite	●	Outstanding wear and heat resistance due to new PVD coating. Suitable for finishing stainless steel.	
		HP885	TiAlN + TiAlSiN	Copper	●	Temperature-resistant cutting material type, finest grain carbide with multilayer PVD coating for universal machining of stainless steels.	
		HP895	TiAlN	Anthracite	↔	TiAlN-coated finest grain carbide with high binder content. Optimised interaction of wear resistance and ductility. Suitable for semi-finishing stainless steel.	
		HP930	AlTiCrN	Black anthracite	●	Fine grain carbide with PVD top coating. Grade for semi-machining and roughing, for machining GJL and GJS.	
		HP945	AlTiCrN	Black anthracite	↔	Fine grain carbide with PVD top coating. For boring steels or stainless steels as well as heat-resistant cast steel.	
		HP950	TiAlSiN	Copper	↔	Ductile fine-grain carbide with PVD coating. For boring workpiece material with highest tensile strength, stainless steels and heat-resistant cast steel.	
	PVD-coated, mixed machining	HP525-P	TiAlXN	Gold brown	●	PVD-coated carbide, particularly suitable for the mixed machining of aluminium and GJL/GJS with smooth cut.	
		HP530-P	TiAlXN	Gold brown	●	PVD-coated carbide, particularly suitable for the mixed machining of aluminium and GJL/GJS with smooth cut to slightly interrupted cut.	
		HP540-P	TiAlXN	Gold brown	●	PVD-coated carbide, particularly suitable for the mixed machining of aluminium and sintered steel with smooth cut to slightly interrupted cut.	
		HP545-P	TiAlXN	Gold brown	●	PVD-coated carbide with a balanced amount of ductility, particularly suitable for the mixed machining of aluminium and sintered steel with smooth cut to slightly interrupted cut.	
	PCD	I	PU617	-	-	●	PCD grade with medium particle size for roughing to semi-machining in non-ferrous metals and for machining very abrasive materials.
			PU660	-	-	●	Fine grain PCD grade for finishing non-ferrous metals as well as non-metallic workpiece materials such as fibre-reinforced plastics. The fine grain lends the insert very good sharpness (chipping) with good resistant to wear and achieves high surface finishes.
			PU670	-	-	↔	PCD cutting material with medium to coarse particle size. Excellent mechanical resistant to wear with good ductility, particularly suitable for machining abrasive workpiece materials.

	P Steel					M Stainless steel					K Cast iron					N Non-ferrous metal					N+K Mixed machining		P+K Mixed machining				
	Wear-resistant		Tough/Ductile			Wear-resistant		Tough/Ductile			Wear-resistant		Tough/Ductile			Wear-resistant		Tough/Ductile			Wear-resistant	Tough/Ductile	Wear-resistant	Tough/Ductile			
	05	15	25	35	45	05	15	25	35	45	05	15	25	35	45	05	15	25	35	45	Cast iron		Sintered steel				
	01	10	20	30	40	50	01	10	20	30	40	50	01	10	20	30	40	50	01	10	20	30	40	50	GJL	GJS	Unalloyed



Product ID codes: Radial indexable inserts

S
C
H
T
0
9
T
3

Blade form

S (90°)

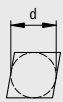
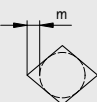
C (80°)

T (60°)

D (55°)

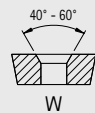
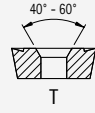
V (35°)

W (82°)**



Tolerance

			
	d [mm]	m [mm]	s [mm]
H	±0.013	±0.013	±0.025
G	±0.025	±0.025	from ±0.05 to ±0.13 *
M	from ±0.05 to ±0.15 *	from ±0.08 to ±0.20 *	from ±0.05 to ±0.13 *

Insert type

W

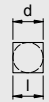
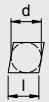
T

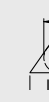
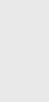
Insert size

Incircle					
d [mm]	S	C	T	D	V
5.56	-	-	09	-	-
6.35	06	06	11	07	11
6.70	-	-	-	-	-
9.525	09	09	16	11	16
12.70	12	12	22	-	-

Clearance angle

	
B	5°
C	7°
P	11°
O	Special shapes

Insert thickness

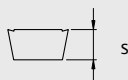
	
Identification number	s [mm]
T1	1.98
02	2.38
03	3.18
T3	3.97
04	4.76

* Tolerance independent of the insert size

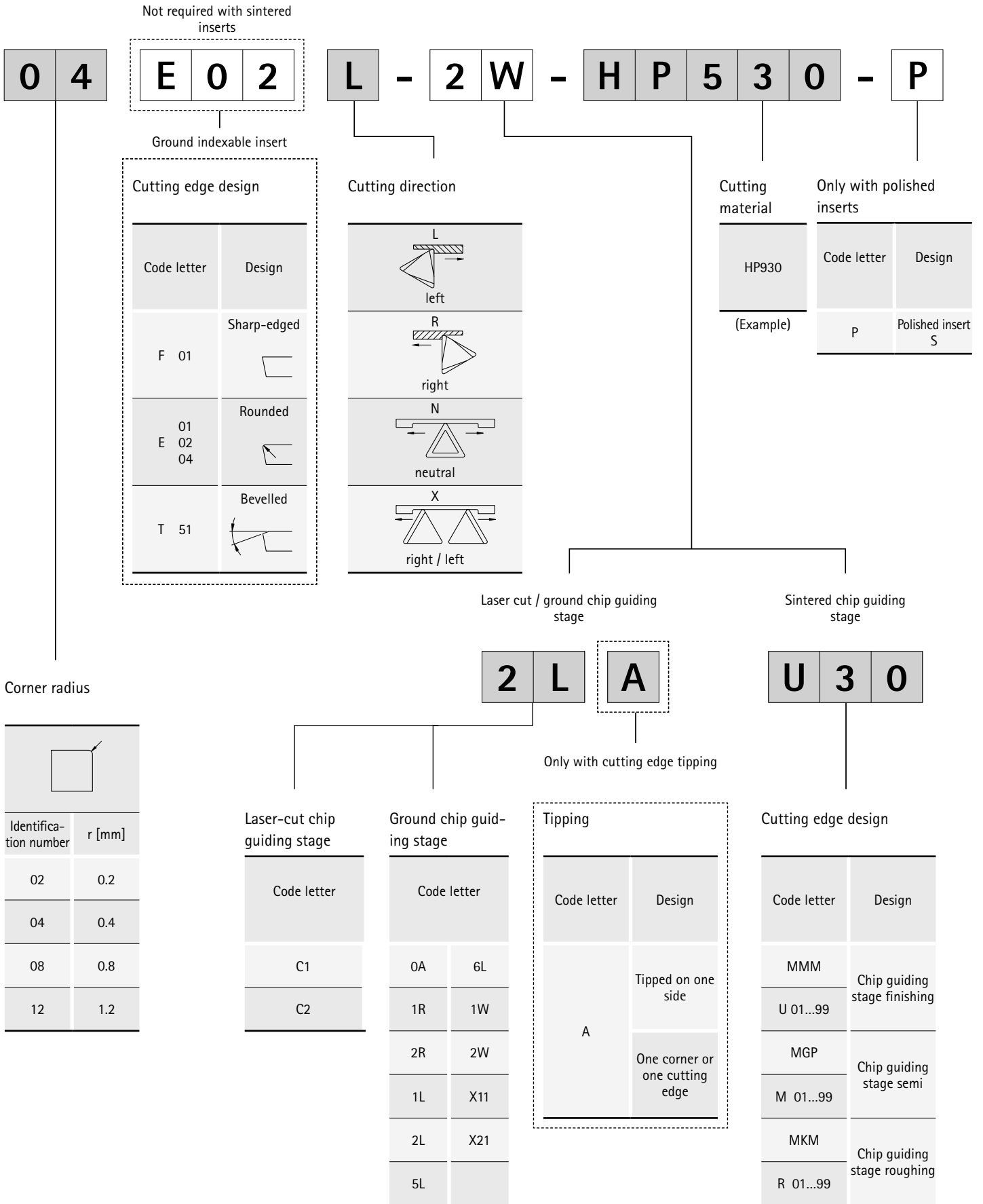

** Drilling from the solid





Product ID codes: Tangential indexable inserts

W T H Q 0 9 0 6 0 8



Blade form

C (80°)	
F (70°)	
S (90°)	

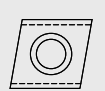
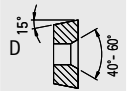
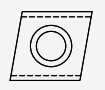
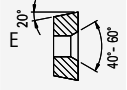

Tolerance

		
	d [mm]	s [mm]
H	±0.013	±0.025
G	±0.025	±0.13
N	±0.05 - ±0.15	±0.025

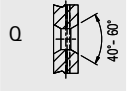
Insert type

Insert size

Incircle			
d [mm]	C	F	S
6.35	06/09	06	06
9.525	09/13	09	09
12.7	12/18	12	-

Indexable insert

T
Tangential

Insert thickness

	Identification number	s [mm]
	03	3.18
	T3	3.97
	04	4.76
	05	5.56
	06	6.35

Corner radius

	Identification number	r [mm]
	00	0
	04	0.4
	08	0.8
	12	1.2

A 3 2 **L** **0 0** **B 0 4 1** - **H U 6 1 5**

Cutting direction

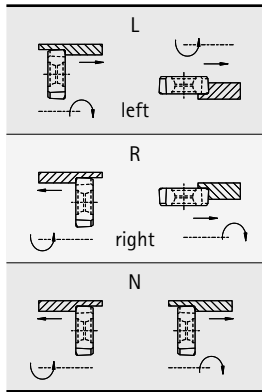

Contact angle

Boring

Arc shaped land

Identification number	Angle
00	0°
10	10°

Cutting material

HU615

(Example)

Chip guiding stage

Code letter
A 01...99
C 01...99
D 01...99
H 01...99

Arc shaped land

Arc shaped land			
	Identifica- tion number	Radius	
Installation position	B012	12	CTHQ/FTHQ
	B016	16	
	B021	21	
	B041	40	
	B081	80	

Overview of chip guiding stages – boring

Radial indexable inserts

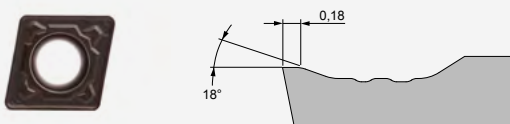
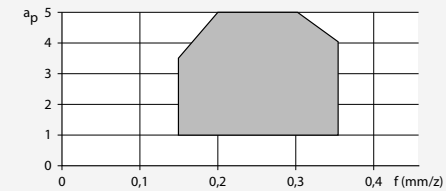
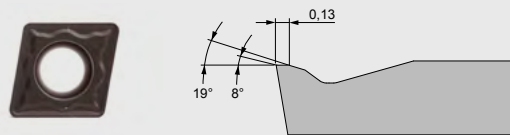
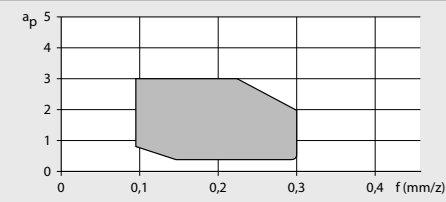
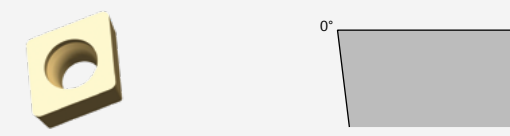
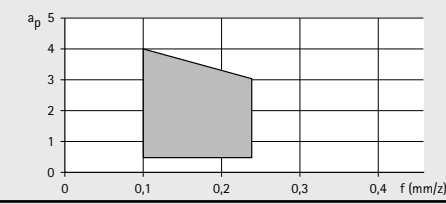
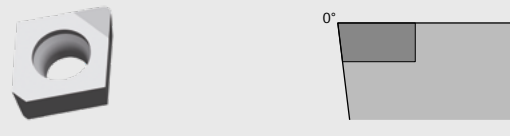
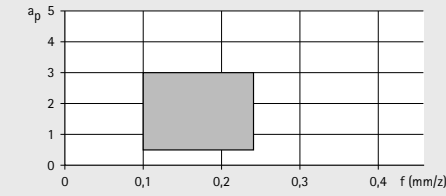



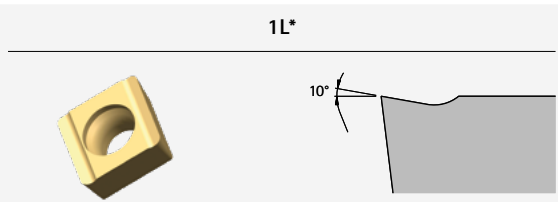
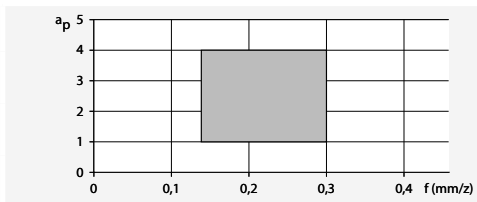
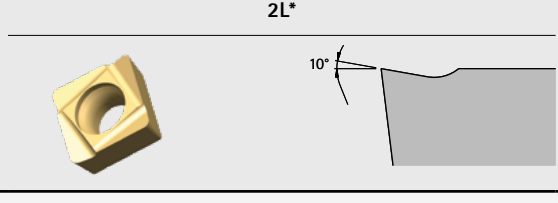
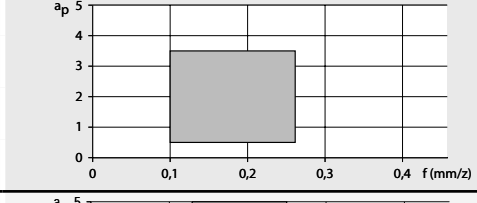
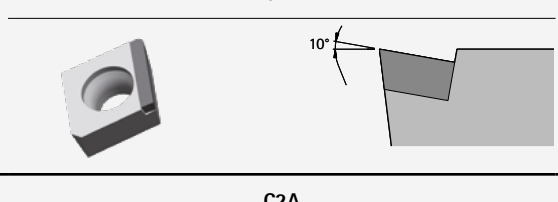
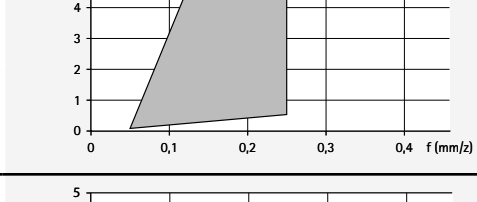
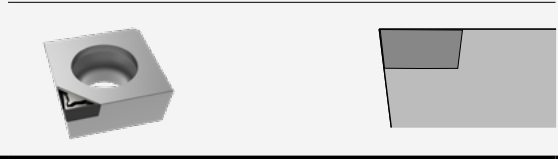
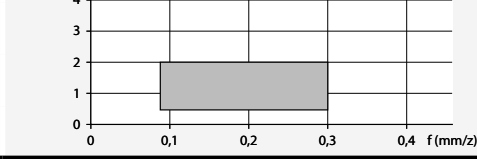
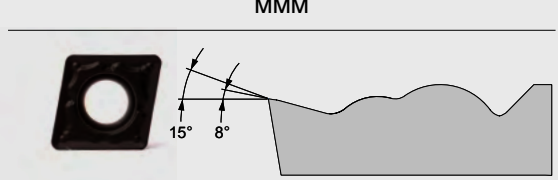
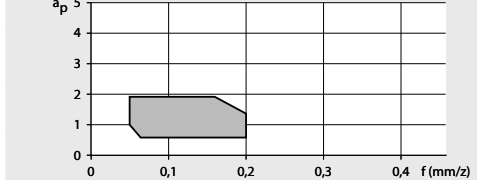
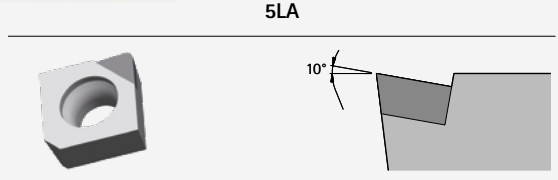
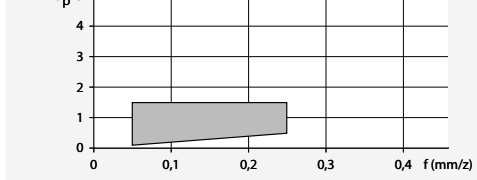
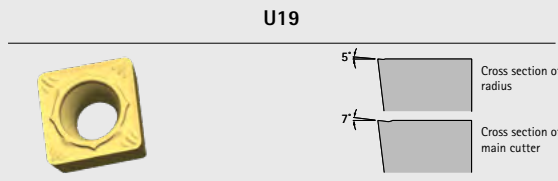
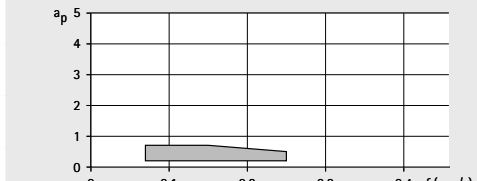
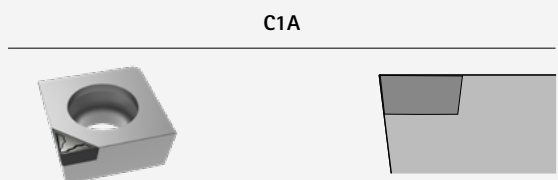
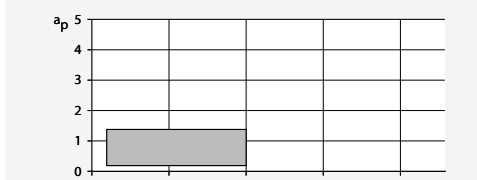

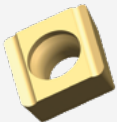

	Type	Workpiece material group	Edge rounding	Diagram
Roughing	MKM 	P M K N	+++	
	MGP 	P M K N	++	
Medium machining	OA* 	P M K N	+ ++	
	OAA* 	P M K N	0 + ++	

* This chip guiding stage is available with different edge rounding.
 0 = sharp edged | + = slightly rounded | ++ = medium rounded | +++ = heavily rounded

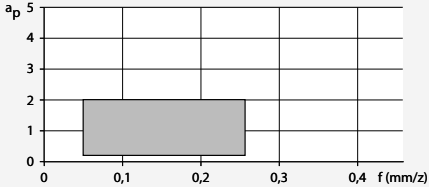
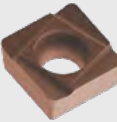
	Type	Workpiece material group	Edge rounding	Diagram
Medium machining	1L* 	P M K N	+ ++	
	2L* 	P M K N	+ ++	
	6LA 	P M K N	0	
	C2A 	P M K N	0	
	MMM 	P M K N	++	
Finishing	5LA 	P M K N	0	
	U19 	P M K N	+	
	C1A 	P M K N	0	

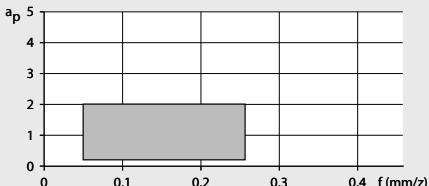
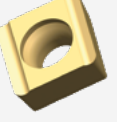
Overview of chip guiding stages – boring

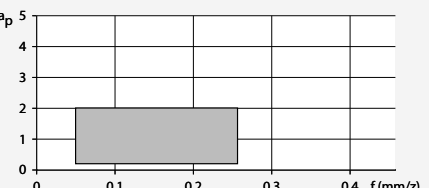
Radial indexable inserts

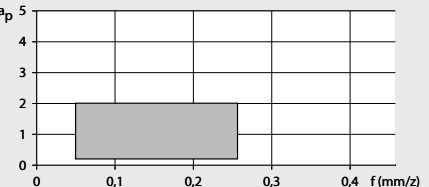
	Type	Workpiece material group	Edge rounding	Diagram
Mixed machining	1R*  	P M K N	0 +	
	2R*  	P M K N	0 +	
	1W  	P M K N	+	
	2W  	P M K N	+	

Marking on "press-to-size" indexable inserts



* This chip guiding stage is available with different edge rounding.
 0 = sharp edged | + = slightly rounded | ++ = medium rounded | +++ = heavily rounded

Overview of chip guiding stages – boring

Tangential indexable inserts

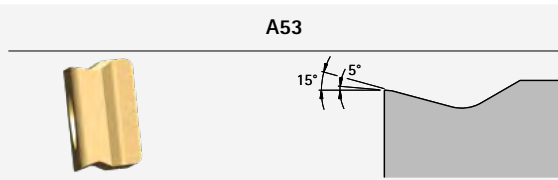
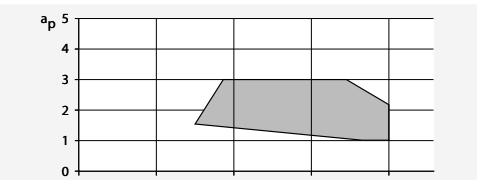
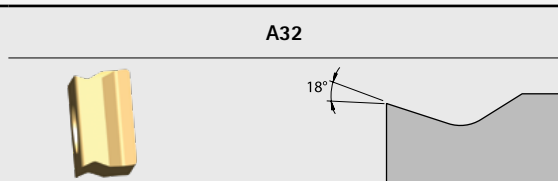
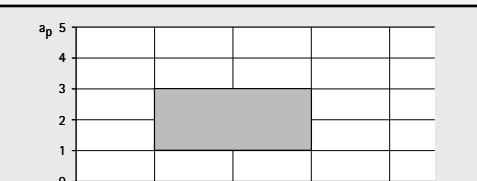
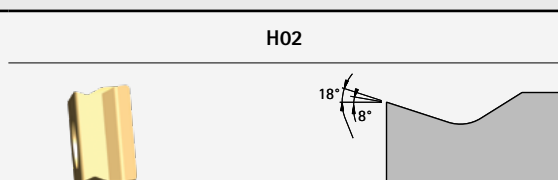
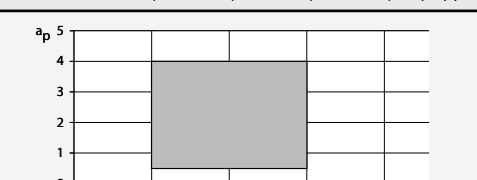
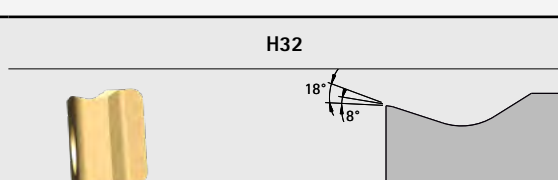
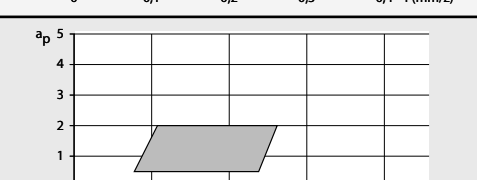
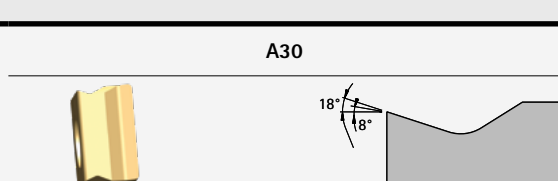
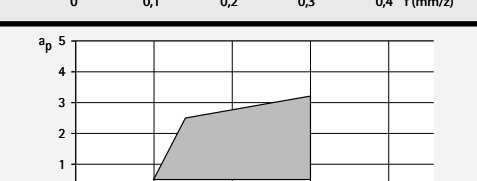
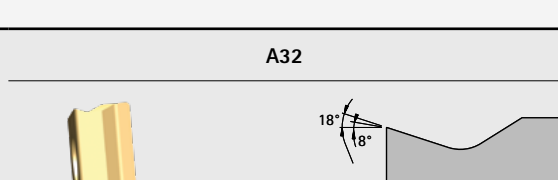
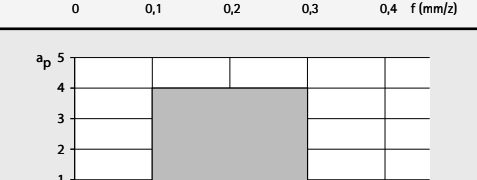
	Type	Workpiece material group	Edge rounding	Diagram
Roughing	A53 	P M K N	++	
	A32 	P M K N	++	
	H02 	P M K N	++	
	H32 	P M K K	++	
Medium machining	A30 	P M K N	0	
	A32 	P M K N	++	

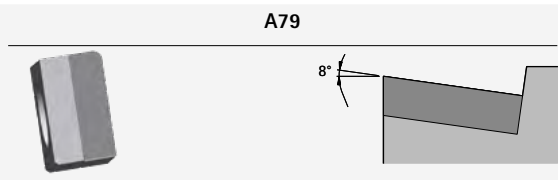
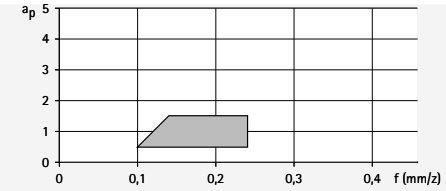
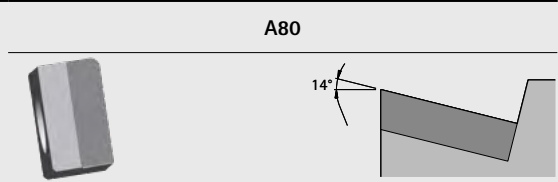
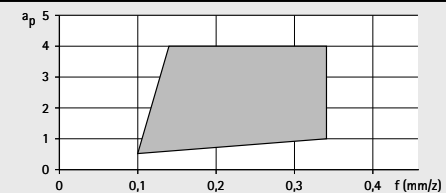
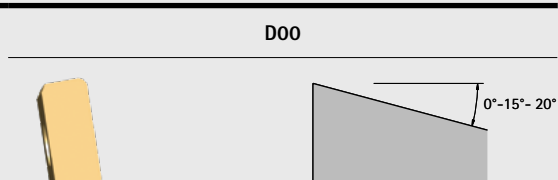
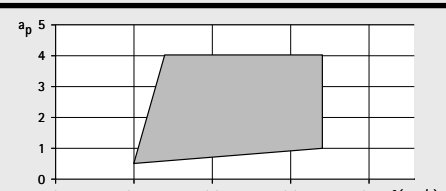
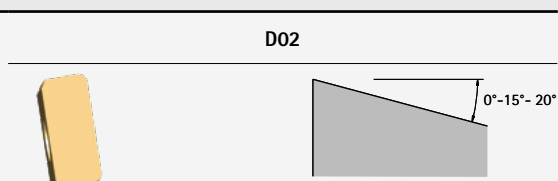
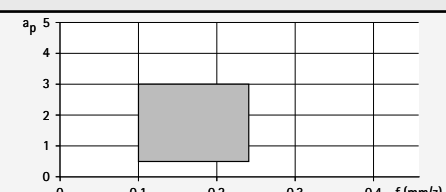
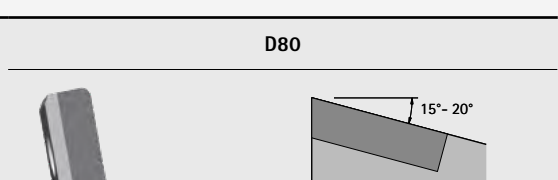
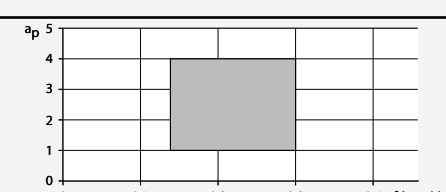
	Type	Workpiece material group	Edge rounding	Diagram
Medium machining	A79 	P M K N	0	
	A80 	P M K N	0	
Universal	D00 	P M K N	0	
	D02 	P M K N	++	
	D80 	P M K N	0	

CCMT

Radial indexable insert, two cutting edges, neutral design

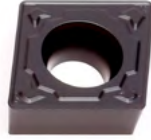

Workpiece material	P				
	Unalloyed Wear-resistant		Alloyed Tough/Ductile	Unalloyed Wear-resistant	Alloyed Tough/Ductile
Substrate	Carbide				
Coating	CVD			PVD	
Cutting material type	HC850	HC855	HC865	HP880	HP895

Cutting edge design		MKM		MKM			
CCMT06	a_p max. [mm]						
Roughing	CCMT060204N-...-	1.5 - 2.5					
	CCMT09						
	CCMT09T304N-...-	1.5 - 3.0			30966062		
		1.5 - 4.0					
	CCMT09T308N-...-	1.5 - 3.0	31265843		30985462		
		1.5 - 4.0					
	CCMT12						
	CCMT120408N-...-	1.5 - 4.0	31265844		30985477		
		1.5 - 5.0					
	CCMT120412N-...-	1.5 - 4.0	31265846		30985485		
1.5 - 5.0							

Cutting edge design		MGP	MGP	MGP	MGP	MGP	
CCMT06	a_p max. [mm]						
Medium machining	CCMT060202N-...-...	0.25 - 2.0					
	CCMT060204N-...-...	0.5 - 2.0		30985423		30985422	
	CCMT060208N-...-...	0.75 - 2.0	30985443			30985442	
	CCMT09						
	CCMT09T302N-...-...	0.25 - 3.0	30985451				
	CCMT09T304N-...-...	0.5 - 3.0		30985455	31092654	30966057	30966058
	CCMT09T308N-...-...	0.75 - 3.0	31265842	30985892	30985461	30985891	30985460
	CCMT12						
	CCMT120404N-...-...	0.5 - 3.0	30985470				
	CCMT120408N-...-...	0.75 - 3.0	30985473		30985474		
CCMT120412N-...-...	1.0 - 3.0	31265845		31092655			

Cutting edge design		MMM		MMM	MMM	MMM	
CCMT06	a_p max. [mm]						
Finishing	CCMT060202N-...-...	0.5 - 1.0	30985415			30985414	
	CCMT060204N-...-...	0.5 - 1.0	30985435		30985436	30985432	30985433
	CCMT060208N-...-...	0.5 - 1.0					30985448
	CCMT09						
	CCMT09T302N-...-...	0.5 - 1.0	30985453				30985452
	CCMT09T304N-...-...	0.5 - 1.0	30985887		30966053	30966070	30955706
	CCMT09T308N-...-...	0.5 - 1.0	30985465		30985896	30985894	30985895

Specified a_p ranges are recommendations and may vary depending on the material being machined.

M					K		
Austenitic Wear-resistant		Ferritic Tough/Ductile	Austenitic Wear-resistant	Ferritic Tough/Ductile	GJL Wear-resistant		GJS Tough/Ductile
CVD					Carbide		
CVD		PVD			CVD		
HC875	HC885	HP880	HP885	HP895	HC820	HC830	
					MKM	MKM	
					30985425	30985427	
					30966120	30985884	
					30966113	30985893	
					30985475	30985476	
					30985481	30985483	
	MGP	MGP	MGP	MGP	MGP	MGP	
	30985420	30985421		31245556	30985422	30985413	30985417
				31245557	30985442	30985439	30985419
						30985450	
	30985883	30966056	30966057	31245558	30966058	30985882	30985454
	30985459	30985890	30985891	31245559	30985460	30985888	30985889
						30985467	30985469
	30985899					30985472	30985898
						30985479	
			MMM	MMM	MMM	MMM	MMM
					30985414		
			30985432	31245539	30985433	30985429	30985431
				31245541	30985448	30985445	30985447
					30985452		
			30966070	31245543	30955706	30985885	30985886
			30985894	31245545	30985895	30985463	30985464

CCGT

Radial indexable insert, two cutting edges, neutral design



Carbide/Cermet

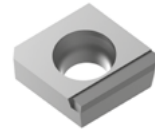

6LA

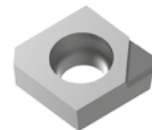

5LA



C1A



C2A

Tipped variants, single edged:

Workpiece material	P		M	N		
				Al alloyed ← Wear-resistant		Cu alloyed → Tough/Ductile
Substrate	Cermet	Carbide	Carbide	PCD		
Coating	CVD	PVD	PVD	-		
Cutting material type	CC112	HP895	HP895	PU617	PU660	PU670

Cutting edge design	a_p max. [mm]		MGP	MGP	6LA	C2A
		CCGT06				
CCGT060202N-...-...	0.25 - 2.0		30985376	30985376		
CCGT060204F01L-...-...	0.1 - 3.0				30708850	
CCGT060204F01R-...-...	0.1 - 3.0				31277722	
CCGT060204N-...-...	0.5 - 2.0		30985378	30985378		
CCGT060208F01L-...-...	0.1 - 3.0				30375239	
CCGT060208F01R-...-...	0.1 - 3.0				31204099	
CCGT060208N-...-...	0.75 - 2.0		30985393	30985393		
CCGT09						
CCGT09T302N-...-...	0.25 - 3.0		30985398	30985398		
CCGT09T304F01L-...-...	0.1 - 4.5				30370125	
CCGT09T304F01R-...-...	0.1 - 4.5				30497774	
CCGT09T304F01N-...-...	0.4 - 1.6					30234061
CCGT09T304N-...-...	0.5 - 3.0		30985400	30985400		
CCGT09T308F01L-...-...	0.1 - 4.5				30370124	
CCGT09T308F01R-...-...	0.1 - 4.5				30370397	
CCGT09T308F01N-...-...	0.5 - 2.0					30234062
CCGT09T308N-...-...	0.75 - 3.0		30985406	30985406		
CCGT12						
CCGT120404N-...-...	0.5 - 3.0		30985410	30985410		
CCGT120404F01L-...-...	0.1 - 7.0				31025433	
CCGT120408N-...-...	0.5 - 3.0		30985411	30985411		
CCGT120408F01L-...-...	0.1 - 7.0				30589862	

Cutting edge design	a_p max. [mm]	U19		5LA	C1A
		CCGT06			
CCGT060204N-...-...	0.1 - 0.5	30874908			
CCGT060204F01N-...-...	0.1 - 1.0			30708851	10104313
CCGT060208N-...-...	0.2 - 0.5	30799422			
CCGT060208F01N-...-...	0.1 - 1.5			31277724	
CCGT09					
CCGT09T304F01N-...-...	0.1 - 2.0			31079089	
CCGT09T304F01N-...-...	0.1 - 1.0				10099042
CCGT09T308F01N-...-...	0.1 - 2.0			31277725	
CCGT09T308F01N-...-...	0.15 - 1.4				30234050

Specified a_p ranges are recommendations and may vary depending on the material being machined.

CCGW

Radial indexable inserts, double edged, neutral design

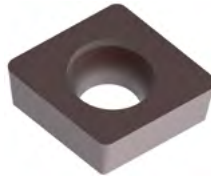

Tipped variant,
single edged:

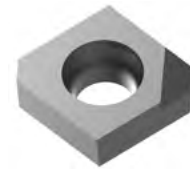

OAA

Workpiece material	K			N		
	GJL ← Wear-resistant	GJS → Tough/Ductile	GJL ← Wear-resistant	GJS → Tough/Ductile	GJL ← Wear-resistant	GJS → Tough/Ductile
Substrate	Carbide			PcBN	PCD	
Coating	CVD		PVD		-	
Cutting material type	HC740		HP930		FU430	PU617

Cutting edge design		OA	OA	OAA		
CCGW06 a_p max. [mm]						
Medium machining	CCGW060204E04N-...-...	0.5 - 3.2	31317178	30950259		
	CCGW060204T51N-...-...	0.5 - 2.0			10105523	
	CCGW060208E04N-...-...	0.5 - 3.2	31317202	30950280		
	CCGW09					
	CCGW09T304E04N-...-...	0.5 - 4.0	31027805	30950281		
	CCGW09T304T51N-...-...	0.5 - 2.5			10105636	
	CCGW09T308E04N-...-...	0.5 - 4.0	31023434	30950282		
	CCGW09T308T51N-...-...	0.5 - 2.5			10105650	
CCGW09T312E04N-...-...	0.5 - 4.0	31317207	30950283			

Cutting edge design			OA	OAA	OAA	
CCGW06 a_p max. [mm]						
Finishing	CCGW060202F01N-...-...	0.1 - 1.0			31277730	
	CCGW060204F01N-...-...	0.1 - 1.0			30492177	
	CCGW060204E01N-...-...	0.1 - 1.0			10105520	
	CCGW060204E02N-...-...	0.2 - 1.0		30950284		
	CCGW060208E02N-...-...	0.2 - 1.0		30950285		
	CCGW09					
	CCGW09T304F01N-...-...	0.1 - 1.0				30418983
	CCGW09T304E01N-...-...	0.1 - 1.0			10105634	
	CCGW09T304E02N-...-...	0.2 - 2.0		30950286		
	CCGW09T308F01N-...-...	0.1 - 1.0				30492178
	CCGW09T308E01N-...-...	0.1 - 1.0			10105648	
	CCGW09T308E02N-...-...	0.2 - 2.0		30950287		

CCHT

Radial indexable inserts, double edged, left design

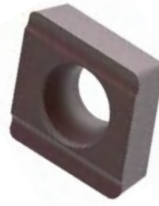

Workpiece material	K		N	
	Carbide		Carbide	
Substrate	CVD		PVD	
Coating	HC740		HP930	
Cutting material type	-		-	
	HU616		HP615	

Cutting edge design		1L	1L		1R	
CCHT06 a_p max. [mm]						
Medium machining	CCHT060204E04L-...-...	0.5 - 3.2	31041976	30950288		
	CCHT060208E04L-...-...	0.5 - 3.2	31115820	30950289		
	CCHT09					
	CCHT09T302F01L-...-...	0.5 - 4.0				30492197
	CCHT09T304F01L-...-...	0.5 - 4.0				30478168
	CCHT09T304E04L-...-...	0.5 - 4.0	30963744	30950290		
	CCHT09T308F01L-...-...	0.5 - 4.0				30484471
	CCHT09T308E04L-...-...	0.5 - 4.0	30884324	30950291		
	CCHT09T312E04L-...-...	0.5 - 4.0	30884469	30950292		
	CCHT12					
	CCHT120404E04L-...-...	0.5 - 5.0	30963715	30950293		
	CCHT120408E04L-...-...	0.5 - 5.0	30894700	30950294		
CCHT120412E04L-...-...	0.5 - 5.0	31317213	30950295			

Cutting edge design			1L	1R	1R	
CCHT06 a_p max. [mm]						
Finishing	CCHT060202F01L-...-...	0.1 - 1.0			30010702	
	CCHT060204F01L-...-...	0.1 - 1.4			30010703	
	CCHT060204E02L-...-...	0.1 - 1.0		30950296		
	CCHT060208F01L-...-...	0.1 - 1.8			30010704	
	CCHT060208E02L-...-...	0.1 - 1.0		30950297		
	CCHT09					
	CCHT09T302F01L-...-...	0.1 - 2.0			30010705	30492197
	CCHT09T304F01L-...-...	0.1 - 2.0			30010706	30478168
	CCHT09T304E02L-...-...	0.1 - 2.0		30950298		
	CCHT09T308F01L-...-...	0.1 - 2.0			30010707	30484471
	CCHT09T308E02L-...-...	0.1 - 2.0		30950299		
	CCHT09T312F01L-...-...	0.1 - 2.0			30084580	
	CCHT12					
	CCHT120402F01L-...-...	0.1 - 3.0			30010708	
	CCHT120404F01L-...-...	0.1 - 3.0			30010709	
	CCHT120408F01L-...-...	0.1 - 3.0			30010710	
CCHT120412F01L-...-...	0.1 - 3.0			30010711		

CCHT

Radial indexable inserts, double edged, right design

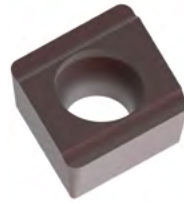

Workpiece material	K		N	
	Carbide		Carbide	
Substrate	CVD		PVD	
Coating	HC740		HP930	
Cutting material type	-		-	
	HU616		HP615	

Cutting edge design		1L	1L		1R
CCHT06	a_p max. [mm]				
CCHT060204E04R-...-...	0.5 - 3.2	31317208	30950300		
CCHT060208E04R-...-...	0.5 - 3.2	31317209	30950301		
CCHT09					
CCHT09T304F01R-...-...	0.5 - 4.0				30478169
CCHT09T304E04R-...-...	0.5 - 4.0	31115392	30950302		
CCHT09T308F01R-...-...	0.5 - 4.0				30492211
CCHT09T308E04R-...-...	0.5 - 4.0	31041977	30950303		
CCHT09T312E04R-...-...	0.5 - 4.0	31317210	30950304		
CCHT12					
CCHT120404E04R-...-...	0.5 - 5.0	31317211	30950305		
CCHT120408E04R-...-...	0.5 - 5.0	31317212	30950306		
CCHT120412E04R-...-...	0.5 - 5.0	31317214	30950307		

Cutting edge design			1L	1R	1R
CCHT06	a_p max. [mm]				
CCHT060202F01R-...-...	0.1 - 1.0			30010732	
CCHT060204F01R-...-...	0.1 - 1.4			30010733	
CCHT060204E02R-...-...	0.1 - 1.0		30950308		
CCHT060208F01R-...-...	0.1 - 1.8			30010734	
CCHT060208E02R-...-...	0.1 - 1.0		30950309		
CCHT09					
CCHT09T302F01R-...-...	0.1 - 2.0			30010735	
CCHT09T304F01R-...-...	0.1 - 2.0			30010736	30478169
CCHT09T304E02R-...-...	0.1 - 2.0		30950310		
CCHT09T308F01R-...-...	0.1 - 2.0			30010737	30492211
CCHT09T308E02R-...-...	0.1 - 2.0		30950311		
CCHT09T312F01R-...-...	0.1 - 2.0			30492212	
CCHT12					
CCHT120402F01R-...-...	0.1 - 3.0			30010738	
CCHT120404F01R-...-...	0.1 - 3.0			30010739	
CCHT120408F01R-...-...	0.1 - 3.0			30010740	
CCHT120412F01R-...-...	0.1 - 3.0			30010741	

DCMT | DCGT | DCGW

Radial indexable insert, two cutting edges, neutral design

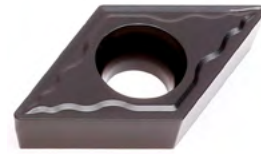

Workpiece material	P				
	← Unalloyed Wear-resistant	Alloyed Tough/Ductile		Unalloyed Wear-resistant	Alloyed Tough/Ductile →
Substrate	Carbide				
Coating	CVD			PVD	
Cutting material type	HC850	HC855	HC865	HP880	HP895

Cutting edge design				MKM		
DCMT11		<i>a_p max. [mm]</i>				
Roughing	DCMT11T304N-...-...	1.5 - 2.5		30966087		
		1.5 - 3.0				
	DCMT11T308N-...-...	1.5 - 3.0		30966078		
		1.5 - 4.0				

Cutting edge design		MGP	MGP	MGP	MGP	MGP	
DCMT07		<i>a_p max. [mm]</i>					
Medium machining	DCMT070202N-...-...	0.25 - 1.8					
	DCMT070204N-...-...	0.5 - 2.0	30985499			30985498	
	DCMT070208N-...-...	0.75 - 2.0		31092658			
	DCMT11						
	DCMT11T304N-...-...	0.25 - 2.0	31092656	30985510	30966101	30966092	30966093
	DCMT11T308N-...-...	0.5 - 2.5	30966103	30985518		30966082	30966083
	DCGT11						
	DCGT11T304F01N-...-...	0.4 - 1.5					
	DCGT11T308F01N-...-...	0.5 - 1.8					
	DCMT15						
DCMT150404N-...-...	0.5 - 2.5						
DCMT150408N-...-...	0.5 - 3.0						
DCMT150412N-...-...	0.5 - 3.0						

Cutting edge design		MMM		MMM	MMM	MMM
DCMT07		<i>a_p max. [mm]</i>				
Finishing	DCMT070202N-...-...	0.5 - 1.0		30985495		30985494
	DCMT070204N-...-...	0.5 - 1.0	30986033			30985500
	DCMT070208N-...-...	0.5 - 1.0				
	DCMT11					
	DCMT11T302N-...-...	0.5 - 1.5	30966100			30985505
	DCMT11T304N-...-...	0.5 - 1.5	30985902	30966088	30966095	30966096
	DCMT11T308N-...-...	0.5 - 1.5	30966104	30966079	30966085	30966086
	DCGT11					
	DCGT11T304F01N-...-...	0.1 - 1.0				
	DCGT11T308F01N-...-...	0.15 - 1.4				
	DCGW11					
	DCGW11T304F01N-...-...	0.1 - 2.0				
	DCGW11T304E01N-...-...	0.1 - 1.0				
	DCGW11T308F01N-...-...	0.1 - 2.0				
DCGW11T308F01N-...-...	0.1 - 1.0					

Specified *a_p* ranges are recommendations and may vary depending on the material being machined.

Tipped variant,
single edged:

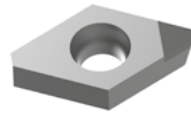

OAA



C1A



C2A

M					K			N			
Austenitic Wear-resistant		Ferritic Tough/Ductile	Austenitic Wear-resistant		Ferritic Tough/Ductile	GJL Wear-resistant		GJS Tough/Ductile	Al alloyed Wear-resistant		Cu alloyed Tough/Ductile
Carbide					Carbide		PcBN	PCD			
CVD		PVD			CVD		-	-			
HC875	HC885	HP880	HP885	HP895	HC815	HC825	FU430	PU617	PU660	PU670	
					MKM	MKM					
						30985511	30985512				
						30985519	30985520				
	MGP	MGP	MGP	MGP	MGP	MGP	MGP			C2A	
						30985493					
				30985498		30985496	30985497				
						30985501	30985502				
	30985508	30966091	30966092	31245560	30966093	30985506	30985507				
	30985517		30966082	31245562	30966083	30985515	30985516				
										30234066	
										30234067	
						30985522					
						30985523					
						30985524					
	MMM		MMM	MMM	MMM	MMM		OAA	OAA	1CA	
	30966105				30985494						
	30966107			31245546	30985500						
				31245547							
					30985505						
			30966095	31245548	30966096	30985513					
	30985903		30966085	31245549	30966086						
										30234052	
										30234053	
									31212079		
							10105921				
									31277726		
							10105952				

SCMT | SPMT | SCGT | SPGT

Radial indexable inserts, four cutting edges, neutral design



Workpiece material	P					
		Unalloyed Wear-resistant		Alloyed Tough/Ductile	Unalloyed Wear-resistant	Alloyed Tough/Ductile
Substrate	Cermet			Carbide		
Coating	CVD		CVD		PVD	
Cutting material type	CC112	HC850	HC855	HC865	HP880	HP895

Cutting edge design			MKM		MKM		
Roughing	SCMT09 SCMT09T308N-...-... <i>a_p max. [mm]</i>	1.5 - 3.0	31265847		30966072		
		1.5 - 4.0					
	SCMT12 SCMT120408N-...-... <i>a_p max. [mm]</i>	1.5 - 4.0	31265848		30985564		
		1.5 - 5.0					
		1.5 - 4.0	31265849				
		1.5 - 5.0					

Cutting edge design			MGP	MGP	MGP		MGP
Medium machining	SPMT06 SPMT060304N-...-... <i>a_p max. [mm]</i>	0.5 - 2.0	30985573		30985575		
		0.75 - 2.0			31265851		
	SCMT09 SCMT09T304N-...-... <i>a_p max. [mm]</i>	0.5 - 3.0	31085129		31085141		30985536
		0.75 - 3.0	31085140	30985543	30966127		
		1 - 3.0	31276723		31273621		
	SCGT09 SCGT09T308F01N-...-... <i>a_p max. [mm]</i>	0.5 - 2.0					
	SCMT12 SCMT120404N-...-... <i>a_p max. [mm]</i>	0.5 - 3.0					
		0.75 - 3.0	31085142	30985560	31085143		

Cutting edge design		U19	MMM		MMM	MMM	MMM	
Finishing	SPMT06 SPMT060304N-...-... <i>a_p max. [mm]</i>	0.5 - 2.0	30985579		30985580	30985577	30985913	
	SPGT06 SPGT060304F01N-...-... <i>a_p max. [mm]</i>	0.1 - 0.8						
		0.1 - 3.0						
		0.1 - 3.0						
		0.1 - 0.8						
		0.1 - 3.0						
		0.1 - 3.0						
	SCMT09 SCMT09T304N-...-... <i>a_p max. [mm]</i>	0.5 - 1.5		31085144		31085145		30985540
		0.5 - 1.5		30983531		30966073	30966076	30955704
	SCGT09 SCGT09T304N-...-... <i>a_p max. [mm]</i>	0.1 - 0.5	30647885					
		0.1 - 0.5						
		0.1 - 4.5						
		0.1 - 4.5						
		0.1 - 0.5	10102893					
		0.1 - 0.5						
		0.15 - 1.4						
		0.1 - 4.5						
		0.1 - 4.5						

Specified *a_p* ranges are recommendations and may vary depending on the material being machined.

Tipped variants,
single edged:

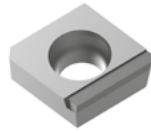

6LA

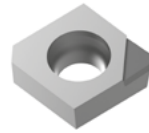

5LA



C1A



C2A

M				K		N									
Austenitic Wear-resistant		Ferritic Tough/Ductile		Austenitic Wear-resistant		Ferritic Tough/Ductile		GJL Wear-resistant		GJS Tough/Ductile		Al alloyed Wear-resistant		Cu alloyed Tough/Ductile	
Carbide						PCD									
CVD		PVD				-									
HC875	HC885	HP880	HP895	HC820	HC830	PU617	PU660	PU670							
				MKM	MKM										
									30985545	31092659					
									30985562	31092660					
									30985566	31092661					
	MGP			MGP	MGP	MGP									C2A
									30985574	30985576					
									30985914	30985915					
	30985535			30985536	30985908	30985534									
	31092662				30985911	30985912									
															30249457
									30985552	30985554					
	30985559				30985556	30985558									
		MMM	MMM	MMM	MMM	MMM	5LA	6LA	C1A						
		30972033	30985577	30985913	30985578	31084646									
									31277727						
										30373268					
										31279699					
									31279698						
										31217111					
										31279720					
				30985540	30985538	30985539									
			30966076	30955704	30985548	30985550									
									30374908						
										30546951					
										31279721					
									30692832						
													30250261		
										30568596					
										31279723					

SCGW | SPGW

Radial indexable inserts, four cutting edges

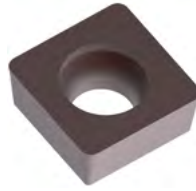

Tipped variant, single edged:

OAA

Workpiece material	K			N			
	GJL ← Wear-resistant	GJS → Tough/Ductile	GJL ← Wear-resistant	GJS → Tough/Ductile	GJL ← Wear-resistant	GJS → Tough/Ductile	
Substrate	Carbide			PcBN		PCD	
Coating	CVD		PVD		-		
Cutting material type	HC740		HP930		FU430		PU617

Cutting edge design		OA	OA	OAA		
SPGW06 a_p max. [mm]						
Medium machining	SPGW060304E04N-...-...	0.5 - 3.2	31070945	30950312		
	SPGW060308E04N-...-...	0.5 - 3.2	31050739	30950313		
	SCGW09					
	SCGW09T304E04N-...-...	0.5 - 4.0	31022296	30950314		
	SCGW09T304T51N-...-...	0.5 - 2.5			10106285	
	SCGW09T308E04N-...-...	0.5 - 4.0	31022297	30950315		
	SCGW09T308T51N-...-...	0.5 - 2.5			10106299	
	SCGW12					
	SCGW120404E04N-...-...	0.5 - 5.0	31317220	30950316		
SCGW120408E04N-...-...	0.5 - 5.0	30939413	30950317			

Cutting edge design			OA	OAA	OAA	
SPGW06 a_p max. [mm]						
Finishing	SPGW060304F01N-...-...	0.1 - 1.2			31277731	
	SPGW060304E02N-...-...	0.2 - 1.0		30950318		
	SPGW060308F01N-...-...	0.1 - 1.0			31279738	
	SPGW060308E02N-...-...	0.2 - 1.0		30950319		
	SCGW09					
	SCGW09T304F01N-...-...	0.1 - 1.4			31277732	
	SCGW09T304E01N-...-...	0.1 - 1.0			10106283	
	SCGW09T304E02N-...-...	0.2 - 2.0		30950320		
	SCGW09T308F01N-...-...	0.1 - 1.8			30429723	
	SCGW09T308E01N-...-...	0.1 - 1.0			10106297	
	SCGW09T308E02N-...-...	0.2 - 2.0		30950321		
	SCGW12					
SCGW120404F01N-...-...	0.1 - 1.4			31279752		
SCGW120408F01N-...-...	0.1 - 1.8			31279753		

Specified a_p ranges are recommendations and may vary depending on the material being machined.

SCHT | SPHT

Radial indexable inserts, double edged, neutral design

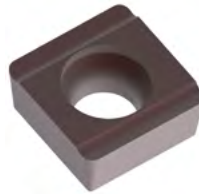

Workpiece material	K		N	
	GJL ← Wear-resistant	GJS → Tough/Ductile	GJL ← Wear-resistant	GJS → Tough/Ductile
Substrate	Carbide			Carbide
Coating	CVD		PVD	
Cutting material type	HC740		HP930	

Cutting edge design		1L	1L		
SPHT06 a_p max. [mm]					
Medium machining	SPHT060304E04X-...-...	0.5 - 3.2	31042317	30953122	
	SPHT060308E04X-...-...	0.5 - 3.2	31317315	30953126	
	SCHT09				
	SCHT09T304E04X-...-...	0.5 - 4.0	31121604	30953127	
	SCHT09T308E04X-...-...	0.5 - 4.0	30963756	30953128	
	SCHT09T312E04X-...-...	0.5 - 4.0	31317219	30953150	
	SCHT12				
	SCHT120404E04X-...-...	0.5 - 5.0	31081857	30953151	
	SCHT120408E04X-...-...	0.5 - 5.0	31317304	30953152	
SCHT120412E04X-...-...	0.5 - 5.0	31317308	30953154		

Cutting edge design			1L	1R	
SPHT06 a_p max. [mm]					
Finishing	SPHT060304E02X-...-...	0.1 - 1.0		30953158	
	SPHT060308E02X-...-...	0.1 - 1.0		30953164	
	SCHT09				
	SCHT09T302F01X-...-...	0.1 - 2.0			30141062
	SCHT09T304F01X-...-...	0.1 - 2.0			30010681
	SCHT09T304E02X-...-...	0.1 - 2.0		30953159	
	SCHT09T308F01X-...-...	0.1 - 2.0			30010682
	SCHT09T308E02X-...-...	0.1 - 2.0		30953168	
	SCHT09T312F01X-...-...	0.1 - 2.0			30492274
	SCHT12				
SCHT120404F01X-...-...	0.1 - 3.0			30010683	
SCHT120408F01X-...-...	0.1 - 3.0			30010684	

SCHT | SPHT

Radial indexable inserts, four cutting edges

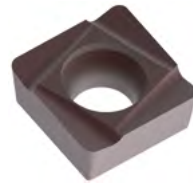

Left design

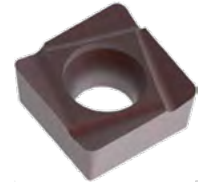

Right design

Workpiece material	K		N	
	GJL ← Wear-resistant	GJS → Tough/Ductile	GJL ← Wear-resistant	GJS → Tough/Ductile
Substrate	Carbide		Carbide	
Coating	CVD		-	PVD
Cutting material type	HC740		HU616	HP615

Cutting edge design		2L	2L		2R	
SPHT06		<i>a_p max. [mm]</i>				
Medium machining	SPHT060302F01L-...-...	0.5 - 3.2			30492231	
	SPHT060302F01R-...-...	0.5 - 3.2			30492248	
	SPHT060304F01L-...-...	0.5 - 3.2			30239958	
	SPHT060304F01R-...-...	0.5 - 3.2			30492249	
	SPHT060304E04L-...-...	0.5 - 3.2	31044035	30950322		
	SPHT060304E04R-...-...	0.5 - 3.2	30939004	30950346		
	SPHT060308F01L-...-...	0.5 - 3.2			30492232	
	SPHT060308F01R-...-...	0.5 - 3.2			30492250	
	SPHT060308E04L-...-...	0.5 - 3.2	31317311	30950323		
	SPHT060308E04R-...-...	0.5 - 3.2	31317314	30950347		
	SCHT09					
	SCHT09T304F01L-...-...	0.5 - 4.0			30492235	
	SCHT09T304F01R-...-...	0.5 - 4.0			30492252	
	SCHT09T304E04L-...-...	0.5 - 4.0	31043583	30950324		
	SCHT09T304E04R-...-...	0.5 - 4.0	30812298	30950348		
	SCHT09T308F01L-...-...	0.5 - 4.0			30042582	
	SCHT09T308F01R-...-...	0.5 - 4.0			30492253	
	SCHT09T308E04L-...-...	0.5 - 4.0	31039585	30950325		
	SCHT09T308E04R-...-...	0.5 - 4.0	31317215	30950349		
	SCHT09T312E04L-...-...	0.5 - 4.0	31317216	30950326		
SCHT09T312E04R-...-...	0.5 - 4.0	31317217	30950350			
SCHT12						
SCHT120404E04L-...-...	0.5 - 5.0	31317284	30950327			
SCHT120404E04R-...-...	0.5 - 5.0	31317287	30950351			
SCHT120408E04L-...-...	0.5 - 5.0	31317300	30950328			
SCHT120408E04R-...-...	0.5 - 5.0	31317301	30950352			
SCHT120412E04L-...-...	0.5 - 5.0	31317305	30950329			
SCHT120412E04R-...-...	0.5 - 5.0	31317307	30950353			

Next table:
Finishing



Specified *a_p* ranges are recommendations and may vary depending on the material being machined.

SCHT | SPHT

Radial indexable inserts, four cutting edges

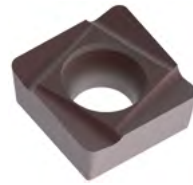

Left design

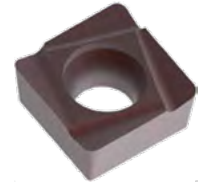

Right design

Workpiece material	K	N	
		Al alloyed ← Wear-resistant	Cu alloyed → Tough/Ductile
Substrate		Carbide	
Coating	PVD	-	PVD
Cutting material type	HP930	HU616	HP615

Cutting edge design		2L	2R	2R	
SPHT06					
	a_p max. [mm]				
Finishing	SPHT060302F01L-...-...	0.1 - 1.0	30092077	30492231	
	SPHT060302F01R-...-...	0.1 - 1.0	30089678	30492248	
	SPHT060304F01L-...-...	0.1 - 1.0	30010644	30239958	
	SPHT060304F01R-...-...	0.1 - 1.0	30010662	30492249	
	SPHT060304E02L-...-...	0.1 - 1.0	30950330		
	SPHT060304E02R-...-...	0.1 - 1.0	30950354		
	SPHT060308F01L-...-...	0.1 - 1.0	30057636	30492232	
	SPHT060308F01R-...-...	0.1 - 1.0	30438143	30492250	
	SPHT060308E02L-...-...	0.1 - 1.0	30950331		
	SPHT060308E02R-...-...	0.1 - 1.0	30950355		
	SCHT09				
	SCHT09T304F01L-...-...	0.1 - 2.0		30010645	30492235
	SCHT09T304F01R-...-...	0.1 - 2.0		30010663	30492252
	SCHT09T304E02L-...-...	0.1 - 2.0	30950332		
SCHT09T304E02R-...-...	0.1 - 2.0	30950356			
SCHT09T308F01L-...-...	0.1 - 2.0		30010646	30042582	
SCHT09T308F01R-...-...	0.1 - 2.0		30010664	30492253	
SCHT09T308E02L-...-...	0.1 - 2.0	30950333			
SCHT09T308E02R-...-...	0.1 - 2.0	30950357			

TCMT | TCGW

Radial indexable insert, three cutting edges, neutral design

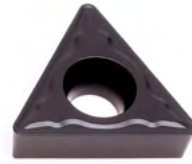

Workpiece material	P				
	Unalloyed Wear-resistant	Alloyed Tough/Ductile	Unalloyed Wear-resistant	Alloyed Tough/Ductile	Alloyed Tough/Ductile
Substrate	Carbide				
Coating	CVD		PVD		
Cutting material type	HC850	HC865	HP880	HP895	
Cutting edge design		MKM			
TCMT11	a_p max. [mm]				
Roughing	TCMT110204N-...-...	1.5 - 3.0	30985591		
		1.5 - 4.0			
	TCMT16				
	TCMT16T304N-...-...	1.5 - 3.0	30985608		
		1.5 - 5.0			
		1.5 - 3.0	30985615		
		1.5 - 5.0			
Cutting edge design		MGP	MGP		MGP
TCMT09	a_p max. [mm]				
Medium machining	TCMT090204N-...-...	0.5 - 2.0	30985582		
	TCMT11				
	TCMT110204N-...-...	0.5 - 2.5	30945048	30985589	30985588
	TCMT110208N-...-...	0.75 - 2.5	30985599	30985600	30985601
	TCGW11				
	TCGW110204T51N-...-...	0.5 - 2.5			
	TCGW110208T51N-...-...	0.75 - 2.5			
	TCMT16				
	TCMT16T304N-...-...	0.5 - 2.5	30985605	31092663	30985604
	TCMT16T308N-...-...	0.75 - 2.5	30985613	31092665	30985612
TCMT16T312N-...-...	1.0 - 2.5		31092666		
TCMT22					
TCMT220408N-...-...	0.75 - 3.0				
Cutting edge design		MMM	MMM	MMM	MMM
TCMT11	a_p max. [mm]				
Finishing	TCMT110202N-...-...	0.5 - 1.5	30985584	30985585	30985583
	TCMT110204N-...-...	0.5 - 1.5	30985595	30985596	30985594
	TCMT110208N-...-...	0.5 - 1.5			
	TCGW11				
	TCGW110204F01N-...-...	0.1 - 1.0			
	TCGW110204E01N-...-...	0.1 - 1.0			
	TCGW110208F01N-...-...	0.1 - 1.5			
	TCGW110208E01N-...-...	0.1 - 1.0			
	TCMT16				
TCMT16T304N-...-...	0.5 - 1.5			30985609	
TCMT16T308N-...-...	0.5 - 1.5			30985617	



Tipped variant, single edged:

0AA

M				K			N
Austenitic ← Wear-resistant		Ferritic → Tough/Ductile		GJL ← Wear-resistant	GJS → Tough/Ductile		
Carbide				Carbide		PcBN	PCD
CVD		PVD		CVD		-	-
HC875	HP880	HP885	HP895	HC815	HC825	FU430	PU617
				MKM			
				30985590			
				30985607			
				30985614			
	MGP		MGP	MGP	MGP	OAA	
				30985917			
30985587			30985588	30985586			
30985598		31245563	30985601	30985597			
						30227880	
						30227892	
			30985604	30985602	30985603		
			30985612	30985610	30985611		
		31245564		30985618	30985619		
				30985622	30985623		
	MMM	MMM	MMM	MMM		OAA	OAA
		30985593	31245550	30985583			
			31245551	30985594	30985592		
							31279724
						30227878	
						30227890	31279725
			31245552	30985609			
30985616		31245553	30985617				

TCHT

Radial indexable inserts, three-cutting edges, left/right design

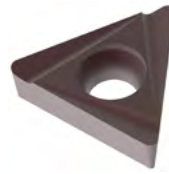

Left design

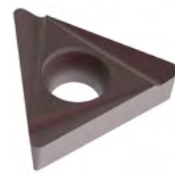

Right design

Workpiece material	K		N
	Carbide		Carbide
Substrate	CVD		PVD
Coating	HC740		HP930
Cutting material type	HC740		HP930
	HU616		

Cutting edge design		2L	2L		
TCHT09		<i>a_p max. [mm]</i>			
Medium machining	TCHT090204E04L-...-...	0.5 - 2.5	31317317	30950224	
	TCHT090204E04R-...-...	0.5 - 2.5	31317318	30950235	
	TCHT090208E04L-...-...	0.5 - 2.5	31317319	30950225	
	TCHT090208E04R-...-...	0.5 - 2.5	31317320	30950236	
	TCHT11				
	TCHT110204E04L-...-...	0.5 - 3.0	31317321	30950226	
	TCHT110204E04R-...-...	0.5 - 3.0	31317322	30950237	
	TCHT110208E04L-...-...	0.5 - 3.0	31317325	30950227	
	TCHT110208E04R-...-...	0.5 - 3.0	31317326	30950238	
	TCHT16				
	TCHT16T304E04L-...-...	0.5 - 4.0	31317327	30950228	
	TCHT16T304E04R-...-...	0.5 - 4.0	31317328	30950239	
	TCHT16T308E04L-...-...	0.5 - 4.0	31317340	30950229	
	TCHT16T308E04R-...-...	0.5 - 4.0	31317342	30950240	

Cutting edge design			2L	2R	
TCHT06		<i>a_p max. [mm]</i>			
Finishing	TCHT06T104F01L-...-...	0.1 - 1.0		30492290	
	TCHT06T104F01R-...-...	0.1 - 1.0		30492307	
	TCHT06T104E02L-...-...	0.1 - 1.0		30950230	
	TCHT06T104E02R-...-...	0.1 - 1.0		30950241	
	TCHT09				
	TCHT090204F01L-...-...	0.1 - 1.0		30010759	
	TCHT090204F01R-...-...	0.1 - 1.0		30010777	
	TCHT090204E02L-...-...	0.1 - 1.0		30950231	
	TCHT090204E02R-...-...	0.1 - 1.0		30950242	
	TCHT090208E02L-...-...	0.1 - 1.0		30950232	
	TCHT090208E02R-...-...	0.1 - 1.0		30950243	
	TCHT11				
	TCHT110202F01L-...-...	0.1 - 1.5		30010761	
	TCHT110202F01R-...-...	0.1 - 1.5		30010779	
	TCHT110204F01L-...-...	0.1 - 1.5		30010762	
	TCHT110204F01R-...-...	0.1 - 1.5		30010780	
	TCHT110204E02L-...-...	0.1 - 1.5		30950233	
	TCHT110204E02R-...-...	0.1 - 1.5		30950244	
	TCHT110208F01L-...-...	0.1 - 1.5		30010763	
	TCHT110208F01R-...-...	0.1 - 1.5		30478186	
	TCHT110208E02L-...-...	0.1 - 1.5		30950234	
	TCHT110208E02R-...-...	0.1 - 1.5		30950245	
	TCHT16				
	TCHT16T304F01L-...-...	0.1 - 2.5		30478187	
	TCHT16T304F01R-...-...	0.1 - 2.5		30478188	
	TCHT16T308F01L-...-...	0.1 - 2.5		30019882	
	TCHT16T308F01R-...-...	0.1 - 2.5		30478189	

Specified *a_p* ranges are recommendations and may vary depending on the material being machined.

TCHT

Radial indexable inserts, single edged, neutral design

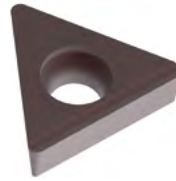

Workpiece material	K		N
Substrate	Carbide		Carbide
Coating	CVD	PVD	
Cutting material type	HC740	HP930	HU616

Cutting edge design		1L	1L	
TCHT09 a_p max. [mm]				
Medium machining	TCHT090204E04X-...-...	0.5 - 2.5	31319106	30950246
	TCHT090208E04X-...-...	0.5 - 2.5	31319107	30950247
	TCHT11			
	TCHT110204E04X-...-...	0.5 - 3.0	31319108	30950248
	TCHT110208E04X-...-...	0.5 - 3.0	31319109	30950249
	TCHT16			
TCHT16T304E04X-...-...	0.5 - 4.0	31039581	30950250	
TCHT16T308E04X-...-...	0.5 - 4.0	31319140	30950251	

Cutting edge design			1L	1R
TCHT06 a_p max. [mm]				
Finishing	TCHT06T104F01X-...-...	0.1 - 1.0		30492325
	TCHT06T104E02X-...-...	0.1 - 1.0		30950252
	TCHT09			
	TCHT090204F01X-...-...	0.1 - 1.0		30010795
	TCHT090204E02X-...-...	0.1 - 1.0		30950253
	TCHT090208E02X-...-...	0.1 - 1.0		30950254
	TCHT11			
	TCHT110202F01X-...-...	0.1 - 1.5		30010797
	TCHT110204F01X-...-...	0.1 - 1.5		30010798
	TCHT110204E02X-...-...	0.1 - 1.5		30950255
	TCHT110208F01X-...-...	0.1 - 1.5		30010799
	TCHT110208E02X-...-...	0.1 - 1.5		30950256
	TCHT16			
	TCHT16T304F01X-...-...	0.1 - 2.5		30019940
TCHT16T308F01X-...-...	0.1 - 2.5		30019941	

VCMT | VCGT | VBGW | VCGW

Radial indexable inserts, double edged, neutral design



Workpiece material	P		
	Unalloyed ← Wear-resistant		Alloyed → Tough/Ductile
Substrate	Carbide		
Coating	CVD		PVD
Cutting material type	HC850	HC865	HP880
Cutting edge design		MKM	
VCMT16	a_p max. [mm]		
Roughing	VCMT160408N-...-...	1.5 - 3.0	30985630
Cutting edge design	MGP	MGP	MGP
VCGT11	a_p max. [mm]		
Medium machining	VCGT110304N-...-...	0.25 - 2.0	30966122
	VCMT16		
	VCMT160404N-...-...	0.5 - 2.0	30966097
	VCMT160408N-...-...	0.75 - 2.0	31093307
Cutting edge design			
VBGW16	a_p max. [mm]		
Finishing	VBGW160404E01N-...-...	0.1 - 1.0	
	VBGW160408E01N-...-...	0.1 - 1.0	
	VCGW16		
	VCGW160404E01N-...-...	0.1 - 1.0	
VCGW160408E01N-...-...	0.1 - 1.0		



Tipped variant,
single edged:

OAA

	M	K	
	Carbide	Carbide	PcBN
	PVD	CVD	-
	HP880	HC815	FU430
	MGP	MGP	
	30966122		
		30985627	
		30985628	
			OAA
			10106686
			10106698
			10106768
			10106780

CCHT | Mixed machining

Radial indexable inserts, double edged, mixed machining

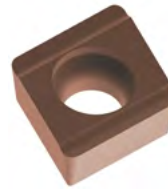

Right design



Left design

Workpiece material	N + K		N + P	
	GJL Wear-resistant		GJS Unalloyed Wear-resistant	
Substrate	Carbide		Carbide	
Coating	PVD		PVD	
Cutting material type	HP525-P	HP530-P	HP540-P	HP545-P

Cutting edge design		1W	1W	1R	1R	
CCHT09		ap max. [mm]				
Radius	CCHT09T304E02L-...-...	0.1 - 2.0 *	30909374	30909375	30907411	30909351
	CCHT09T304E02R-...-...	0.1 - 2.0	30909376	30909377	30909352	30909353
	CCHT09T308E02L-...-...	0.1 - 2.0	30909378	30909379	30909354	30909355
	CCHT09T308E02R-...-...	0.1 - 2.0	30909380	30909381	30909356	30909357

* Depending on the thrust bearing.
Also possible for custom inserts.

SCHT | Mixed machining

Radial indexable inserts, four cutting edges, mixed machining

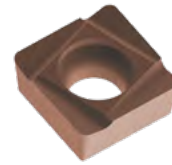

with radius, left design

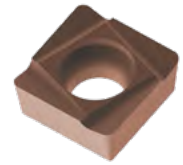

with radius, right design

Workpiece material	N + K		N + P	
	GJL ← Wear-resistant		GJS → Unalloyed ← Wear-resistant	
Substrate	Carbide		Carbide	
Coating	PVD		PVD	
Cutting material type	HP525-P	HP530-P	HP540-P	HP545-P

Cutting edge design		2W	2W	2R	2R	
Radius	SCHT09	a_p max. [mm]				
	SCHT09T304E02L-...-...	0.1 - 2.0	30909366	30909367	30909345	30909346
	SCHT09T304E02R-...-...	0.1 - 2.0	30909368	30909369	30909347	30909348
	SCHT09T308E02L-...-...	0.1 - 2.0	30909370	30909371	30909349	30909350
	SCHT09T308E02R-...-...	0.1 - 2.0	30909372	30909373	30903215	30907589

Specified a_p ranges are recommendations and may vary depending on the material being machined.

CTNQ

Tangential indexable inserts, four cutting edges, without arc shaped land

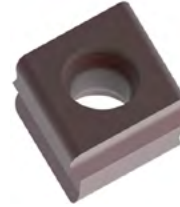

Workpiece material	P			M ₁	
	Unalloyed Wear-resistant			Alloyed Tough/Ductile	
Substrate	Carbide			Carbide	
Coating	CVD		PVD		CVD
Cutting material type	HC740		HP945	HP950	HC750

Cutting edge design			H02	H02	H02	A32
CTNQ from ø 41 mm		a _p max. [mm]				
Roughing	CTNQ090508...L-...	1.5 - 3.0	30933846	30933848	30933849	30950088
		1.5 - 4.0				
	CTNQ090508...R-...	1.5 - 3.0	30933850	30933851	30950091	30950092
		1.5 - 4.0				
	CTNQ090512...L-...	1.5 - 3.0	30933852	30933854	30933855	30950094
		1.5 - 4.0				
	CTNQ090512...R-...	1.5 - 3.0	30933856	30933857	30950097	30950099
		1.5 - 4.0				
	CTNQ from ø 54 mm					
	CTNQ120608...L-...	1.5 - 3.0	30933864	30933866	30933867	
		1.5 - 5.0				
	CTNQ120612...L-...	1.5 - 3.0	30933868	30933869	30980913	
1.5 - 5.0						

Cutting edge design			A32	A32	A32	A32
CTNQ from ø 41 mm		a _p max. [mm]				
Medium machining	CTNQ090508...L-...	0.5 - 2.0	30933892	30933894	30933895	30950088
	CTNQ090508...R-...	0.5 - 2.0	30933896	30933897	30950112	30950092
	CTNQ090512...L-...	0.5 - 2.0	30933898	30933900	30933901	30950094
	CTNQ090512...R-...	0.5 - 2.0	30933902	30933903	30950118	30950099

M₁ Stainless steel

M₂ Heat-resistant cast steel (turbocharger materials)

Specified a_p ranges are recommendations and may vary depending on the material being machined.

M ₂			K			
Austenitic Wear-resistant	Ferritic Tough/Ductile		GJL Wear-resistant	GJS Tough/Ductile	GJL Wear-resistant	GJS Tough/Ductile
Carbide			Carbide			
CVD		PVD	CVD		PVD	
HC740	HC750	HP945	HC725	HC740	HP930	HP945
H02	H02	H02	H02	H02	H02	H02
30933846	30980873	30933848	30933926	30933846	30933929	30933848
30933850	30980900	30933851	30933931	30933850	30933934	30933851
30933852	30980902	30933854	30933936	30933852	30933939	30933854
30933856	30980905	30933857	30933941	30933856	30933944	30933857
30933864	30980907	30933866	30933956	30933864	30933959	30933866
30933868	30980911	30933869	30933961	30933868	30933964	30933869
A32	A32	A32	A32	A32	A32	A32
30933892	30950088	30933894	30934005	30933892	30934008	30933894
30933896	30950092	30933897	30934010	30933896	30934013	30933897
30933898	30950094	30933900	30934015	30933898	30934018	30933900
30933902	30950099	30933903	30934020	30933902	30934023	30933903

CTGQ

Tangential indexable inserts, four cutting edges, blind bore, with arc shaped land



Workpiece material	P				K			
	Unalloyed Wear-resistant	Alloyed Tough/Ductile	Unalloyed Wear-resistant	Alloyed Tough/Ductile	GJL Wear-resistant	GJS Tough/Ductile	GJL Wear-resistant	GJS Tough/Ductile
Substrate	Carbide				Carbide			
Coating	CVD		PVD		CVD		PVD	
Cutting material type	HC740	HC745	HP945	HP950	HC725	HC740	HP930	HP945

Cutting edge design		H02	H02	H02	H02	H02	H02	H02	H02	
CTGQ ø 65 mm		a_p max. [mm]								
Roughing	CTGQ090504...L00B041-...	1.5 - 3.0	31173955	31173956	31173957	31173958				
		1.5 - 4.0					31173959	31173955	31173980	31173957
	CTGQ090508...L00B041-...	1.5 - 3.0	31173981	31173982	31173983	31173984				
		1.5 - 4.0					31173985	31173981	31173986	31173983
	CTGQ090512...L00B041-...	1.5 - 3.0	31173987	31184714	31173988	31184715				
		1.5 - 4.0					31173989	31173987	31173990	31173988
	CTGQ ø 78 mm									
	CTGQ120604...L00B081-...	1.5 - 3.0	31184725	31184726	31184728	31184729				
		1.5 - 5.0					31184724	31184725	31184727	31184728
	CTGQ120608...L00B081-...	1.5 - 3.0	31173995	31173996	31173997	31173998				
		1.5 - 5.0					31173999	31173995	31174000	31173997
	CTGQ120612...L00B081-...	1.5 - 3.0	31184731	31184732	31184734	31184735				
1.5 - 5.0						31184730	31184731	31184733	31184734	

Cutting edge design		A32	A32	A32	A32	A32	A32	A32	A32	
CTGQ ø 65 mm		a_p max. [mm]								
Medium machining	CTGQ090504...L00B041-...	0.5 - 2.0	31174001	31184716	31174002	31184717	31174003	31174001	31174004	31174002
	CTGQ090508...L00B041-...	0.5 - 2.0	31174005	31184718	31174006	31184719	31174007	31174005	31174008	31174006
	CTGQ090512...L00B041-...	0.5 - 2.0	31174009	31184720	31174010	31184721	31174011	31174009	31174012	31174010

CTGQ

Tangential indexable inserts, four cutting edges, through bore, with arc shaped land



Workpiece material	P				K					
	Unalloyed Wear-resistant	Alloyed Tough/Ductile	Unalloyed Wear-resistant	Alloyed Tough/Ductile	GJL Wear-resistant	GJS Tough/Ductile	GJL Wear-resistant	GJS Tough/Ductile		
Substrate	Carbide				Carbide					
Coating	CVD		PVD		CVD		PVD			
Cutting material type	HC740	HC745	HP945	HP950	HC725	HC740	HP930	HP945		
Cutting edge design	H02	H02	H02	H02	H02	H02	H02	H02		
CTGQ from ø 65 mm a_p max. [mm]										
Roughing	CTGQ090508...L10B041-...	1.5 - 3.0	31174013	31174014	31174015	31174016				
		1.5 - 4.0					31174017	31174013	31174018	31174015
	CTGQ from ø 78 mm									
	CTGQ120608...L10B081-...	1.5 - 3.0	31174019	31174020	31174021	31174022				
1.5 - 5.0						31174023	31174019	31174024	31174021	
Cutting edge design	A32	A32	A32	A32	A32	A32	A32	A32		
CTGQ from ø 65 mm a_p max. [mm]										
Medium machining	CTGQ090508...L10B041-...	0.5 - 2.0	31174029	31184722	31174031	31184723	31174030	31174029	31174032	31174031

Specified a_p ranges are recommendations and may vary depending on the material being machined.

CTHQ

Tangential indexable inserts, four cutting edges, without arc shaped land

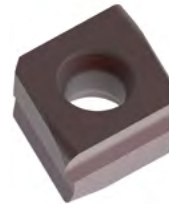

Left design



Right design

Workpiece material	P		M ₁	M ₂		M ₂
				Unalloyed Wear-resistant	Alloyed Tough/Ductile	
Substrate	Carbide		Carbide	Carbide		Carbide
Coating	CVD	PVD	CVD	CVD		PVD
Cutting material type	HC740	HP945	HC750	HC740	HC750	HP945

Cutting edge design							
CTHQ from ø 28 mm		<i>a_p max. [mm]</i>					
Roughing	CTHQ060408...L-...	1.5 - 2.5					
	CTHQ060408...R-...	1.5 - 2.5					
	Cutting edge design			A32	H02	H02	H02
	CTHQ from ø 41 mm		<i>a_p max. [mm]</i>				
	CTHQ090508...L-...	1.5 - 3.0		30950084	30980629	30980631	30980632
		1.5 - 4.0					
	CTHQ090508...R-...	1.5 - 3.0		30950086	30980712	30980714	30980751
		1.5 - 4.0					
	CTHQ from ø 54 mm						
	CTHQ120608...L-...	1.5 - 3.0			30980759	30980765	30980766
1.5 - 5.0							
CTHQ120608...R-...	1.5 - 3.0			30980784	30980786	30980787	
	1.5 - 5.0						
Cutting edge design		A32	A32		A32	A32	A32
CTHQ from ø 28 mm		<i>a_p max. [mm]</i>					
Medium machining	CTHQ060404...R-...	0.5 - 2.0					
	CTHQ from ø 41 mm						
	CTHQ090504...L-...	0.5 - 2.0	30933878	30933880		30933878	30980967
	CTHQ090504...R-...	0.5 - 2.0				30980968	
	CTHQ090508...L-...	0.5 - 2.0	30813598	30933885		30813598	30950084
	CTHQ090508...R-...	0.5 - 2.0				30950086	
	CTHQ from ø 54 mm						
	CTHQ120604...L-...	0.5 - 2.0	30933904			30933904	
CTHQ120604...R-...	0.5 - 2.0	30980051			30980051		

M₁ Stainless steel

M₂ Heat-resistant cast steel (turbocharger materials)

Specified *a_p* ranges are recommendations and may vary depending on the material being machined.



Tipped variants, single edged:

A79, A80

K				N		
GJL ← Wear-resistant		GJS → Tough/Ductile		GJL ← Wear-resistant		GJS → Tough/Ductile
Carbide				Carbide		PCD
CVD		PVD		-	PVD	-
HC725	HC740	HP930	HP945	HU616	HP615	PU617
H32	H32	H32	H32			
30933907	30980615	30933910	30980618			
30933912	30980621		30980625			
H02	H02	H02	H02			A80
30921024	30980629	30933917	30980632			30492720
30921023	30980712	30933923	30980751			30515656
30933946	30980759	30933949	30980766			
30933951	30980784	30933954	30980787			
A32	A32	A32	A32	A30	A30	A80
30679873	30942364		30942366	30477914		
30679874	30933878	30933979	30933880	30492760	31010211	30492764
30679875		30942374		30492770		30515411
30724676	30813598	30933994	30933885	31186236	30610917	
30789885		30942382		31264530	31203830	
30789886	30933904	30934028		30477929		
30789887	30980051	30980054		30477930		

CTHQ

Tangential indexable inserts, four cutting edges, blind bore, with arc shaped land

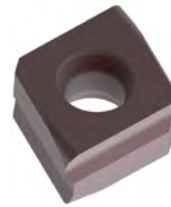

Workpiece material	P				M ₂	
	Unalloyed Wear-resistant	Alloyed Tough/Ductile	Unalloyed Wear-resistant	Alloyed Tough/Ductile		
Substrate	Carbide				Carbide	
Coating	CVD		PVD		CVD	
Cutting material type	HC740	HC745	HP945	HP950	HC750	

Cutting edge design		A53	A53	A53	A53	A32	
CTHQ from ø 65 mm	a _p max. [mm]						
Roughing	CTHQ090508...L00B041-...	1.5 - 3.0	30933714	30933715	30933716	30933717	30933718
		1.5 - 4.0					
	CTHQ090512...L00B041-...	1.5 - 3.0	30950047				
		1.5 - 4.0					
	CTHQ from ø 78 mm						
	CTHQ120608...L00B081-...	1.5 - 3.0	30933733	30933734			
1.5 - 5.0							
CTHQ120612...L00B081-...	1.5 - 3.0	30950048					
	1.5 - 5.0						

Cutting edge design		A32		A32			
CTHQ from ø 40 mm	a _p max. [mm]						
Medium machining	CTHQ060404...L00B021-...	0.5 - 2.0					
		0.5 - 2.0					
	CTHQ from ø 65 mm						
	CTHQ090504...L00B041-...	0.5 - 2.0	30950080		30988741		
	CTHQ090508...L00B041-...	0.5 - 2.0	30988732		30988742		
	CTHQ from ø 78 mm						
CTHQ120604...L00B081-...	0.5 - 2.0						
	CTHQ120608...L00B081-...	0.5 - 2.0	30988734		30988744		

M₂ Heat-resistant cast steel (turbocharger materials)

Specified a_p ranges are recommendations and may vary depending on the material being machined.



Tipped variants, single edged:

A79, A80

K				N	
GJL ← Wear-resistant		GJS → GJL Tough/Ductile ← Wear-resistant		GJS → Tough/Ductile	
Carbide				Carbide	PCD
CVD		PVD		-	-
HC725	HC740	HP930	HP945	HU616	PU617
H02	H02	H02	H02		A80
30933721	30988707	30933724	30988736		30492584
30933727	30988708	30933730	30988737		
30933735	30988709	30933738	30988738		
	30988730		30988739		
A32	A32	A32	A32	A30	A80
30679863	30988748	30933807	30988753	30477916	30492674
30679858	30950080	30933756	30988741	30328643	
30679859	30988732	30933765	30988742	30307194	30492584
30789881	31322355	31322356	31322357	30477928	
30789882	30988734	30933777	30988744	30477931	31213527

CTHQ

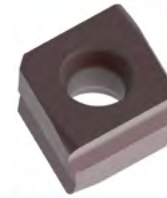

Tangential indexable inserts, four cutting edges, through bore, with arc shaped land

Workpiece material	P				M ₂		
	Unalloyed Wear-resistant	Alloyed Tough/Ductile	Unalloyed Wear-resistant	Alloyed Tough/Ductile			
Substrate	Carbide				Carbide		
Coating	CVD		PVD		CVD		
Cutting material type	HC740	HC745	HP945	HP950	HC750		
Cutting edge design	A53	A53	A53	A53	A32		
CTHQ from ø 65 mm <i>a_p max. [mm]</i>							
Roughing	CTHQ090508...L10B041-...	1.5 - 3.0	30933783	30933784	30933785	30933786	30933787
		1.5 - 4.0					
	CTHQ from ø 78 mm						
	CTHQ120608...L10B081-...	1.5 - 3.0	30950082				
		1.5 - 5.0					
Cutting edge design	A32		A32				
CTHQ from ø 40 mm <i>a_p max. [mm]</i>							
Medium machining	CTHQ060408...L10B021-...	0.5 - 2.0					
	CTHQ from ø 65 mm						
	CTHQ090508...L10B041-...	0.5 - 2.0	30988749		30988755		
	CTHQ from ø 78 mm						
CTHQ120608...L10B081-...	0.5 - 2.0	30988750		30988756			

M₂ Heat-resistant cast steel (turbocharger materials)

Specified *a_p* ranges are recommendations and may vary depending on the material being machined.



Tipped variants, single edged:

A79, A80

K				N	
GJL ← Wear-resistant		GJS → GJL Tough/Ductile		GJS → GJL Tough/Ductile	
Carbide				Carbide	PCD
CVD		PVD		-	-
HC725	HC740	HP930	HP945	HU616	PU617
H02	H02	H02	H02		A80
30933790	30988746	30933793	30988751		30492657
30933796	30988747	30933799	30988752		
A32	A32	A32	A32	A30	A80
30679863	30988748	30933807	30988753	30477916	
30679865	30988749	30933825	30988755	30307197	30492657
	30988750		30988756	30477932	

FTNQ

Tangential indexable inserts, four cutting edges, without arc shaped land

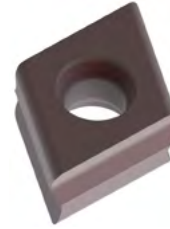

Workpiece material	P		M ₁	M ₂	
				Austenitic Wear-resistant	Ferritic Tough/Ductile
Substrate	Carbide		Carbide	Carbide	
Coating	CVD	PVD	CVD	CVD	
Cutting material type	HC740	HP945	HC750	HC740	HC750

Cutting edge design	H02	H02	A32	H02	H02
---------------------	-----	-----	-----	-----	-----

FTNQ from ø 30 mm a_p max. [mm]

Roughing	FTNQ090508...L-...	1.5 - 3.0	30934169	30934170	30934171	30934169	30980508
		1.5 - 4.0					
	FTNQ from ø 40 mm						
	FTNQ120608...L-...	1.5 - 3.0	30934188	30934189		30934188	30980523
		1.5 - 5.0					
	FTNQ120608...R-...	1.5 - 3.0	30934196	30934197		30934196	
1.5 - 5.0							

Cutting edge design	A32	A32		A32	A32
---------------------	-----	-----	--	-----	-----

FTNQ from ø 30 mm a_p max. [mm]

Medium machining	FTNQ090508...L-...	0.5 - 2.0	30934222	30934223		30934222	30934171
		0.5 - 2.0					

M₁ Stainless steelM₂ Heat-resistant cast steel (turbocharger materials)Specified a_p ranges are recommendations and may vary depending on the material being machined.

	M₂	K					
		GJL ← Wear-resistant		GJS → Tough/Ductile	GJL ← Wear-resistant		GJS → Tough/Ductile
	Carbide	Carbide					
	PVD	CVD		PVD			
	HP945	HC725	HC740	HP930	HP945		
	H02	H02	H02	H02	H02		
	30934170						
		30934173	30934169	30934175	30934170		
	30934189						
		30934192	30934188	30934194	30934189		
	30934197						
		30934198	30934196	30934200	30934197		
	A32	A32	A32	A32	A32		
	30934223						
		30934173	30934222	30934175	30934223		

FTGQ

Tangential indexable inserts, four cutting edges, blind bore, with arc shaped land



Workpiece material	P				K			
	Unalloyed Wear-resistant	Alloyed Tough/Ductile	Unalloyed Wear-resistant	Alloyed Tough/Ductile	GJL Wear-resistant	GJS Tough/Ductile	GJL Wear-resistant	GJS Tough/Ductile
Substrate	Carbide				Carbide			
Coating	CVD		PVD		CVD		PVD	
Cutting material type	HC740	HC745	HP945	HP950	HC725	HC740	HP930	HP945

Cutting edge design			H02	H02	H02	H02	H02	H02	H02	H02	
FTGQ from \varnothing 30 mm		a_p max. [mm]									
Roughing	FTGQ090504...L00B016-...	1.5 - 3.0	31174033	31174034	31174035	31174036					
		1.5 - 4.0					31174037	31174033	31174038	31174035	
	FTGQ090508...L00B016-...	1.5 - 3.0	31174039	31174040	31174041	31174042					
		1.5 - 4.0					31174043	31174039	31174044	31174041	
	FTGQ090512...L00B016-...	1.5 - 3.0	31184737	31184738	31184740	31184741					
		1.5 - 4.0					31184736	31184737	31184739	31184740	
	FTGQ from \varnothing 40 mm										
	FTGQ120604...L00B021-...	1.5 - 3.0	31184755	31184756	31184758	31184759					
		1.5 - 5.0					31184754	31184755	31184757	31184758	
	FTGQ120608...L00B021-...	1.5 - 3.0	31174045	31174046	31174047	31174048					
		1.5 - 5.0					31174049	31174045	31174050	31174047	
	FTGQ120612...L00B021-...	1.5 - 3.0	31184761	31184762	31184764	31184765					
1.5 - 5.0						31184760	31184761	31184763	31184764		

Cutting edge design			A32	A32	A32	A32	A32	A32	A32	A32
FTGQ from \varnothing 30 mm		a_p max. [mm]								
Medium machining	FTGQ090504...L00B016-...	0.5 - 2.0	31174051	31184742	31174053	31184743	31174052	31174051	31174054	31174053
	FTGQ090508...L00B016-...	0.5 - 2.0	31174055	31184744	31174057	31184745	31174056	31174055	31174058	31174057
	FTGQ090512...L00B016-...	0.5 - 2.0	31184747	31184748	31184750	31184751	31184746	31184747	31184749	31184750

FTGQ

Tangential indexable inserts, four cutting edges, through bore, with arc shaped land



Workpiece material	P				K					
	Unalloyed Wear-resistant	Alloyed Tough/Ductile	Unalloyed Wear-resistant	Alloyed Tough/Ductile	GJL Wear-resistant	GJS Tough/Ductile	GJL Wear-resistant	GJS Tough/Ductile		
Substrate	Carbide				Carbide					
Coating	CVD		PVD		CVD		PVD			
Cutting material type	HC740	HC745	HP945	HP950	HC725	HC740	HP930	HP945		
Cutting edge design	H02	H02	H02	H02	H02	H02	H02	H02		
FTGQ from \varnothing 30 mm a_p max. [mm]										
Roughing	FTGQ090508...L10B016-...	1.5 - 3.0	31174059	31174060	31174061	31174062				
		1.5 - 4.0					31174063	31174059	31174065	31174061
	FTGQ from \varnothing 40 mm									
	FTGQ120608...L10B021-...	1.5 - 3.0	31174066	31174067	31174068	31174069				
1.5 - 5.0						31174070	31174066	31174071	31174068	
Cutting edge design	A32	A32	A32	A32	A32	A32	A32	A32		
FTGQ from \varnothing 30 mm a_p max. [mm]										
Medium machining	FTGQ090508...L10B016-...	0.5 - 2.0	31174076	31184752	31174078	31184753	31174077	31174076	31174079	31174078

FTHQ

Tangential indexable inserts, four cutting edges, without arc shaped land

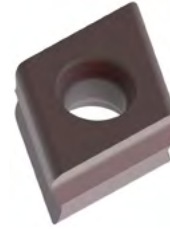

Workpiece material	P		M ₁		
			Austenitic ← Wear-resistant → Ferritic Tough/Ductile		
Substrate	Carbide		Carbide		
Coating	CVD	PVD	CVD	PVD	
Cutting material type	HC740	HP945	HC750	HC740	HC750

Cutting edge design		A53	A53	A32	H02	H02	
FTHQ from ø 30 mm		<i>a_p max. [mm]</i>					
Roughing	FTHQ090508...L-...	1.5 - 3.0	30980167	30934159	30934160	30912756	30980484
		1.5 - 4.0					
	FTHQ090508...R-...	1.5 - 3.0	30934166	30934167	30950130	30980488	
		1.5 - 4.0					
	FTHQ from ø 40 mm						
	FTHQ120608...L-...	1.5 - 3.0	30934177	30934178	30934179	30980491	30980493
	1.5 - 5.0						
FTHQ120608...R-...	1.5 - 3.0	30934185	30934186	30950135	30980501		
	1.5 - 5.0						

Cutting edge design		A32	A32		A32	A32	
FTHQ from ø 22 mm		<i>a_p max. [mm]</i>					
Medium machining	FTHQ060404...L-...	0.5 - 1.5					
	FTHQ060404...R-...	0.5 - 1.5					
	FTHQ060408...L-...	0.5 - 1.5					
	FTHQ060408...R-...	0.5 - 1.5					
	FTHQ from ø 30 mm						
	FTHQ090504...L-...	0.5 - 2.0					
	FTHQ090504...R-...	0.5 - 2.0					
	FTHQ090508...L-...	0.5 - 2.0	30934214	30934215		30934214	30934160
	FTHQ090508...R-...	0.5 - 2.0					30950130
	FTHQ from ø 40 mm						
	FTHQ120604...L-...	0.5 - 2.0					
	FTHQ120604...R-...	0.5 - 2.0					
	FTHQ120608...L-...	0.5 - 2.0	30934231	30934232		30934231	30934179
	FTHQ120608...R-...	0.5 - 2.0					30950135

M₁ Stainless steelM₂ Heat-resistant cast steel (turbocharger materials)Specified *a_p* ranges are recommendations and may vary depending on the material being machined.

FTHQ

Tangential indexable inserts, four cutting edges, blind bores, with arc shaped land

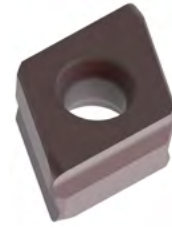

Workpiece material	P				M	
	Unalloyed Wear-resistant	Alloyed Tough/Ductile	Unalloyed Wear-resistant	Alloyed Tough/Ductile	Austenitic Wear-resistant	Ferritic Tough/Ductile
Substrate	Carbide				Carbide	
Coating	CVD		PVD		CVD	
Cutting material type	HC740		HP945		HC750	
Cutting edge design	A53		A53		A32	
FTHQ from \varnothing 30 mm	a_p max. [mm]					
Roughing	FTHQ090508...L00B016-...	1.5 - 3.0	30980181	30934058	30934059	
		1.5 - 4.0				
	FTHQ090512...L00B016-...	1.5 - 3.0	30934075	30934076		
		1.5 - 4.0				
	FTHQ from \varnothing 40 mm					
	FTHQ120608...L00B021-...	1.5 - 3.0	30934081	30934082		
1.5 - 5.0						
FTHQ120612...L00B021-...	1.5 - 3.0	30934087	30934088			
	1.5 - 5.0					
Cutting edge design	A32					
FTHQ from \varnothing 22 mm	a_p max. [mm]					
Medium machining	FTHQ060404...L00B012-...	0.5 - 1.5				
	FTHQ060408...L00B012-...	0.5 - 1.5				
	FTHQ from \varnothing 30 mm					
	FTHQ090504...L00B016-...	0.5 - 2.0	30950123			
	FTHQ090508...L00B016-...	0.5 - 2.0	30901249			
	FTHQ from \varnothing 40 mm					
	FTHQ120604...L00B021-...	0.5 - 2.0				
FTHQ120608...L00B021-...	0.5 - 2.0	30934113				
FTHQ120612...L00B021-...	0.5 - 2.0					



Tipped variant,
single edged:

A79, A80

K		K		N		
GJL ← Wear-resistant		GJS → Tough/Ductile		GJL ← Wear-resistant		GJS → Tough/Ductile
Carbide CVD		Carbide PVD		Carbide		PCD
HC725	HC740	HP930	HP945	HU616		PU617
H02	H02	H02	H02			A80
30934071	30934057	30934073	30988760			30492784
30934077	30988757	30934079	30988761			
30934083	30988758	30934085	30988762			
30934089	30988759	30934091	30988763			
A32	A32	A32	A32	A30	A79	A80
30679879	30950121	30934095	30988764	30477935		
30679880	30950122	30934099	30988765	30477936	30492816	
30679881	30950123	30934103	30988766	30477942		
30679882	30901249	30934111	30934106	30478043		30492784
30934115	30934113	30934118	30934114	30477950		
				30477952		
				30492842		

Specified a_p ranges are recommendations and may vary depending on the material being machined.

FTHQ

Tangential indexable inserts, four cutting edges, through bores, with arc shaped land

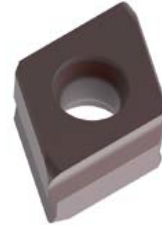

Workpiece material	P		M	K			
	Carbide		Carbide	Carbide			
Substrate	CVD		PVD	CVD			
Coating	HC740		HP945	HC750	HC725	HC740	
Cutting material type	A53		A53	A32	H02	H02	
Cutting edge design	A53		A53	A32	H02	H02	
FTHQ from \varnothing 30 mm	a_p max. [mm]						
Roughing	FTHQ090508...L10B016-...	1.5 - 3.0	30934120	30934121	30934122		
		1.5 - 4.0				30934124	30988767
	FTHQ from \varnothing 40 mm						
	FTHQ120608...L10B021-...	1.5 - 3.0	30934128	30934129			
1.5 - 5.0					30934130	30988768	
Cutting edge design	A32		A32		A32	A32	
FTHQ from \varnothing 22 mm	a_p max. [mm]						
Medium machining	FTHQ060408...L10B012-...	0.5 - 1.5				30679886	30942386
		FTHQ from \varnothing 30 mm					
	FTHQ090508...L10B016-...	0.5 - 2.0	30942389	30942390		30679888	30942389
		FTHQ from \varnothing 40 mm					
FTHQ120608...L10B021-...	0.5 - 2.0	30942391	30942392		30789889	30942391	



Tipped variant,
single edged:

A79, A80

K		N		
GJL ← Wear-resistant		GJS → Tough/Ductile		
Carbide		Carbide		PCD
PVD		-		-
HP930	HP945	HU616		PU617
H02	H02			A80
30934126	30988769			30492850
30934132	30988770			30668155
A32	A32	A30	A79	A80
30942394	30942388	30477937	30492868	
30942397	30942390	30477944		30492850
30942400	30942392	30477953		30668155

Specified a_p ranges are recommendations and may vary depending on the material being machined.

STHD - STHE

Tangential indexable inserts, four cutting edges, chamfers, neutral design



Tipped variant,
single edged:



D80

Workpiece material	M ₂	K			N		
	Substrate	Carbide	Carbide		Carbide	PCD	
Coating	PVD	CVD	PVD	-	-		
Cutting material type	HP930	HC725	HP930	HU616	PU617		
Cutting edge design	D02	D02	D02	D00	D80		
STH_06	<i>a_p max. [mm]</i>						
Chamfering	STHD060300...N-...	0.1 - 4.2	30950141	30774242	30950141	30213884	30493003
	STHE060300...N-...	0.1 - 4.2	30950142	30789899	30950142	30228119	30370122
	STH_09						
	STHD09T300...N-...	0.1 - 6.3	30950143	30631370	30950143	30215016	30493005
STHE09T300...N-...	0.1 - 6.3	30950144	30631351	30950144	30257365	30493006	

M₂ Heat-resistant cast steel (turbocharger materials)

Specified *a_p* ranges are recommendations and may vary depending on the material being machined.







Accessories for tangential indexable inserts

Indexable insert	Size of indexable insert	Clamping screw					Screwdriver
		Dimension [MxL]	Description	Tightening torque [Nm]	Torx size	Order no.	Order no.
CT... 	0604	M2.5 x 8.7	MN659 M2.5x8.7-TX8-IP	1	TX8-IP	30533284	30414760
	0905	M3.5 x 11	MN659 M3.5x11-TX10-IP	2.8	TX10-IP	10105079	30414763
	1206	M5 x 14	MN659 M5x14-TX20-IP	7.5	TX20-IP	10006485	30414766
FT... 	0604	M2.5 x 8.7	MN659 M2.5x8.7-TX8-IP	1	TX8-IP	30533284	30414760
	0905	M3.5 x 11	MN659 M3.5x11-TX10-IP	2.8	TX10-IP	10105079	30414763
	1206	M5x14	MN659 M5x14-TX20-IP	7.5	TX20-IP	10006485	30414766
ST... 	0603	M2.5 x 6	MN659 M2.5x6-TX8-IP	1	TX8-IP	10105073	30414760
	09T3	M3.5x9	MN659 M3.5x9-TX15-IP	2.8	TX15-IP	10105078	30414764

High-temperature screw paste

Ceramic paste/re-sealable PE tube 30 g	30861389	
--	----------	--

Accessories for radial indexable inserts

Indexable insert	Size of indexable insert	Clamping screw					Screwdriver
		Dimension [MxI]	Description	Tightening torque [Nm]	Torx size	Order no.	Order no.
CC... 	0602	M2.5 x 6	MN659 M2.5x6-TX8-IP	1	TX8-IP	10105073	30414760
	09T3	M3.5 x 9	MN659 M3.5x9-TX15-IP	2.8	TX15-IP	10105078	30414764
	1204	M5 x 11	MN659 M5x11-TX20-IP	7.5	TX20-IP	10105082	30414766
DC... 	0702	M2.5 x 6	MN659 M2.5x6-TX8-IP	1	TX8-IP	10105073	30414760
	11T3	M3.5 x 9	MN659 M3.5x9-TX15-IP	2.8	TX15-IP	10105078	30414764
	1504	M5x11	MN659 M5x11-TX20-IP	7.5	TX20-IP	10105082	30414766
SP... 	0603	M2.5 x 6	MN659 M2.5x6-TX8-IP	1	TX8-IP	10105073	30414760
TC... 	06T1	M2 x 4.95	MN659 M2x4.95-TX6-IP	0.5	TX6-IP	10002712	30414758
	0902	M2.2 x 5.5	MN659 M2.2x5.5-TX7-IP	0.8	TX7-IP	10105070	30414759
	1102	M2.5 x 6	MN659 MN2.5x6-TX8-IP	1	TX8-IP	10105073	30414760
	16T3	M3.5 x 9	MN659 M3.5x9-TX15-IP	2.8	TX15-IP	10105078	30414764
	2204	M5x11	MN659 M5x11-TX20-IP	7.5	TX20-IP	10105082	30414766
SC... 	09T3	M3.5 x 9	MN659 M3.5x9-TX15-IP	2.8	TX15-IP	10105078	30414764
	1204	M5 x 11	MN659 M5x11-TX20-IP	7.5	TX20-IP	10105082	30414766
VB-/VC... 	1103	M2.5 x 6	MN659 MN2.5x6-TX8-IP	1	TX8-IP	10105073	30414760
	1604	M3.5 x 9	MN659 M3.5x9-TX15-IP	2.8	TX15-IP	10105078	30414764

Cutting data recommendation for boring tools with indexable inserts (1/2)

Cutting speed [m/min]

MMG*		Workpiece material	Strength/hardness [N/mm ²] [HRC]	Cermet		PcBN	
				CVD-coated	PVD-coated	uncoated	
				CC112	CP872	FU430	HC725
P	P1	P1.1	Structural, free-cutting, case hardened and heat-treated steels, non-alloy	< 700	160-600	200-300	
		P1.2	Structural, free-cutting, case hardened and heat-treated steels, non-alloy	< 1,200	160-500		
	P2	P2.1	Nitrided, case hardened and heat-treated steels, alloy	< 900	160-600	120-220	
		P2.2	Nitrided, case hardened and heat-treated steels, alloy	< 1,400	140-400		
	P3	P3.1	Tool, bearing, spring and high-speed steels**	< 800	160-600	120-220	
		P3.2	Tool, bearing, spring and high-speed steels**	< 1,000	140-400		
		P3.3	Tool steels, roller bearing steels, spring steels and high-speed steels**	< 1,500			
	P4	P4.1	Stainless steels, ferritic and martensitic		140-400		
	P5	P5.1	Cast steel		140-400		
	P6	P6.1	Stainless steels, ferritic and martensitic		140-400		
M	M1	M1.1	Stainless cast steel, ferritic and martensitic	< 700	100-500		
		M1.2	Stainless steels, ferritic/austenitic (duplex)	< 1,000	100-450		
	M2	M2.1	Stainless/heat-resistant cast steel, austenitic	< 700	100-500		
	M3	M3.1	Stainless cast steel, ferritic/austenitic (duplex)	< 1,000	100-450		
K	K1	K1.1	Cast iron with lamellar graphite (grey cast iron), GJL	< 300		400-1.000	140-300
		K2.1	Cast iron with spheroidal graphite, GJS	< 500		350-800	120-260
	K2	K2.2	Cast iron with spheroidal graphite, GJS	≤ 800			120-220
		K2.3	Cast iron with spheroidal graphite, GJS	> 800			80-140
	K3	K3.1	Cast iron with spheroidal graphite, GJV; malleable cast iron, GJM	< 500			80-130
		K3.2	Cast iron with spheroidal graphite, GJV; malleable cast iron, GJM	> 500			80-120
N	N1	N1.1	Aluminium, unalloyed and alloyed < 3 % Si				
		N1.2	Aluminium, alloyed ≤ 7 % Si				
		N1.3	Aluminium, alloyed > 7-12 % Si				
		N1.4	Aluminium, alloyed > 12 % Si				
	N2	N2.1	Copper, non-alloy and low-alloy	< 300			
		N2.2	Copper, alloy	> 300			
	N3	N2.3	Brass, bronze, gunmetal	< 1,200			
		N3.1	Graphite, > 8 µm	< 1,200			
	N4	N3.2	Graphite, ≤ 8 µm				
		N4.1	Plastic, thermoplastics				
N4.2		Plastic, thermosets					
	N4.3	Plastic, foams					
K+K	K1.1, K1.2	Mixed machining of cast iron (GJL and GJS)					
K+P	K1.1, Sinter	Mixed machining of cast iron and sintered steel					
N+K	N1.2, K1.1	Mixed machining of aluminium and cast iron (GJL)					
	N1.2, K1.2	Mixed machining of aluminium and cast iron (GJS)					
N+P	N1.2, Sinter	Mixed machining of aluminium and sintered steel					

* MAPAL machining groups

** If the alloy parts Cr, Mo, Ni, V, W in total > 8 % then select the next highest MAPAL machining group.

Carbide												
CVD-coated												
HC740	HC745	HC750	HC815	HC820	HC825	HC830	HC850	HC855	HC865	HC875	HC885	
100-220	100-200						180-300	170-280	120-220			
100-220	100-200						170-280	160-250	120-200			
100-180	100-180						150-270	150-250	100-180			
80-150	80-150						150-260	150-240	80-170			
100-180	100-180						150-260	140-240	80-160			
90-130	80-130						140-240	140-230	80-140			
90-130	80-130						140-240	130-230	80-140			
90-130	80-130						140-240	120-220	80-140			
		100-160								200-300	180-280	
		80-140								200-280	160-260	
70-120	70-120	70-120								180-260	140-240	
		70-130								160-240	120-220	
120-240			200-380	200-380	180-300	180-300						
110-230			150-280	150-280	130-260	130-260						
100-200			150-220	150-220	130-200	130-200						
80-120			150-200	150-200	130-200	130-200						
80-120			150-200	150-200	130-200	130-200						
80-120			150-200	150-200	130-200	130-200						

The specified machining values are guide values.
 The optimum data for the respective machining task should be determined during the test or machining.

Cutting data recommendation for boring tools with indexable inserts (2/2)

Cutting speed [m/min]

MMG*		Workpiece material	Strength/hardness [N/mm ²] [HRC]	PVD-coated				
				HP615	HP880	HP885	HP895	
P	P1	P1.1	Structural, free-cutting, case hardened and heat-treated steels, non-alloy	< 700		100-220		100-220
		P1.2	Structural, free-cutting, case hardened and heat-treated steels, non-alloy	< 1,200		100-220		100-220
	P2	P2.1	Nitrided, case hardened and heat-treated steels, alloy	< 900		100-220		100-220
		P2.2	Nitrided, case hardened and heat-treated steels, alloy	< 1,400		100-200		100-200
	P3	P3.1	Tool, bearing, spring and high-speed steels**	< 800		80-200		80-200
		P3.2	Tool, bearing, spring and high-speed steels**	< 1,000		80-200		80-200
		P3.3	Tool steels, roller bearing steels, spring steels and high-speed steels**	< 1500				
	P4	P4.1	Stainless steels, ferritic and martensitic			80-200		80-200
	P5	P5.1	Cast steel					
	P6	P6.1	Stainless steels, ferritic and martensitic			80-200		80-200
M	M1	M1.1	Stainless cast steel, ferritic and martensitic	< 700		150-220	100-180	150-220
		M1.2	Stainless steels, ferritic/austenitic (duplex)	< 1,000		120-200	100-160	120-200
	M2	M2.1	Stainless/heat-resistant cast steel, austenitic	< 700		100-180	80-150	100-180
	M3	M3.1	Stainless cast steel, ferritic/austenitic (duplex)	< 1,000		100-180	60-140	100-180
K	K1	K1.1	Cast iron with lamellar graphite (grey cast iron), GJL	< 300				
		K2.1	Cast iron with spheroidal graphite, GJS	< 500				
	K2	K2.2	Cast iron with spheroidal graphite, GJS	≤ 800				
		K2.3	Cast iron with spheroidal graphite, GJS	> 800				
	K3	K3.1	Cast iron with spheroidal graphite, GJV; malleable cast iron, GJM	< 500				
		K3.2	Cast iron with spheroidal graphite, GJV; malleable cast iron, GJM	> 500				
N	N1	N1.1	Aluminium, unalloyed and alloyed < 3 % Si		150-600			
		N1.2	Aluminium, alloyed ≤ 7 % Si		100-500			
		N1.3	Aluminium, alloyed > 7-12 % Si		100-400			
		N1.4	Aluminium, alloyed > 12 % Si					
	N2	N2.1	Copper, non-alloy and low-alloy	< 300	100-350			
		N2.2	Copper, alloy	> 300	100-300			
		N2.3	Brass, bronze, gunmetal	< 1,200	100-250			
	N3	N3.1	Graphite, > 8 µm	< 1,200				
		N3.2	Graphite, ≤ 8 µm					
	N4	N4.1	Plastic, thermoplastics					
N4.2		Plastic, thermosets						
N4.3		Plastic, foams						
K1+K2	K1.1, K1.2	Mixed machining of cast iron (GJL and GJS)						
K+P	K1.1, sintered	Mixed machining of cast iron and sintered steel						
N+K	N1.2, K1.1	Mixed machining of aluminium and cast iron (GJL)						
	N1.2, K1.2	Mixed machining of aluminium and cast iron (GJS)						
N+P	N1.2, sintered	Mixed machining of aluminium and sintered steel						

* MAPAL machining groups

** If the alloy parts Cr, Mo, Ni, V, W in total > 8 % then select the next highest MAPAL machining group.

Carbide							PCD			
			PVD-coated, mixed machining				uncoated	uncoated		
HP930	HP945	HP950	HP525-P	HP530-P	HP540-P	HP545-P	HU616	PU617	PU660	PU670
	100-180	100-160								
	100-180	100-160								
	100-180	100-160								
	80-150	80-150								
	100-180	100-160								
	80-130	90-130								
	80-130	90-130								
	80-130	90-130								
	80-130	90-130								
	70-120	70-120								
140-220	120-200									
120-200	120-180									
120-180	120-180									
80-140	80-120									
60-130	60-100									
60-120	60-100									
							150-500	450-2200	450-2200	410-1980
							100-450	400-1700	400-1700	360-1530
							100-400	350-1300	350-1300	320-1170
								200-800	200-800	180-720
							100-250	250-600	250-600	230-540
							100-220	200-600	200-600	180-540
							80-220	200-500	200-500	180-450
							120-480	300-600	300-600	270-540
							250-500	400-1000	400-1000	360-900
							250-500	400-1000	400-1000	360-900
			120-220	120-220	120-200					
				120-200	120-200	110-200				
			120-300	120-300	120-230					
			120-280	120-280	120-230					
				120-220	120-230	110-200				

The specified machining values are guide values.
 The optimum data for the respective machining task should be determined during the test or machining.



TECHNICAL APPENDIX

Notes on application, handling and cutting data

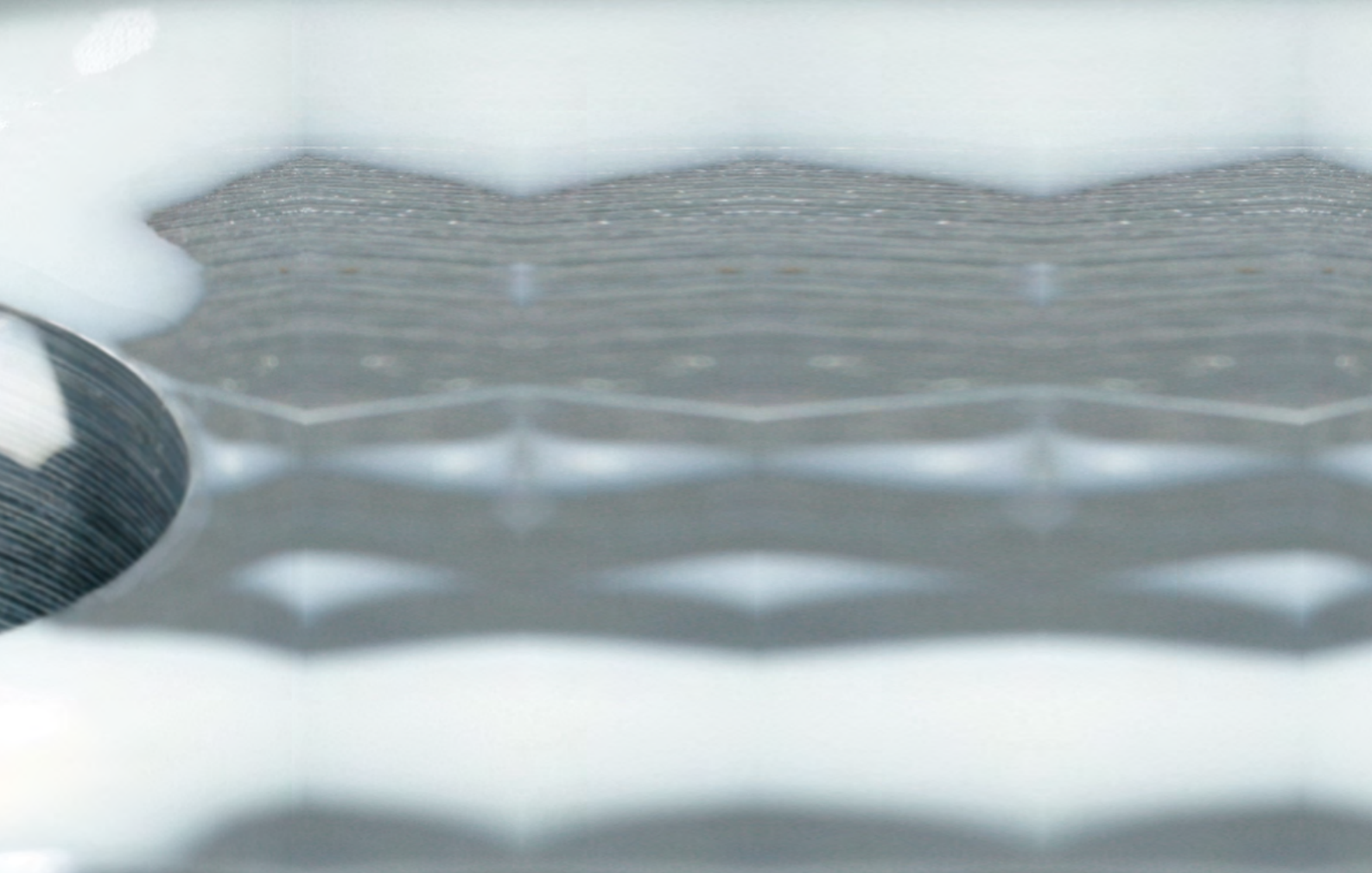



59.5
Antriebsauslastung - Anzeige
X1 Y1 Z1 C1 B1 SPM U1
Kanal 1
01/07 Service Info
DATE: 03.04.11
TIME: 16:28:05
MEL 4 Betriebsart aktiv
NC/UKS/4_1471_SPM_STANDARDPROG/SPM_2_2
702012 4
RESET
UKS
Position [mm]
X 226.533
Y 33.867
Z 46.362
C 0.000
B 0.000
G55
TFS
T SPM_STANDARD D1
F SPM_STANDARD R0.000 L137.750
S1 Master 0 mm/min 0.0%
100%
Zoom Istwert
T.S.M NPV setzen Hulp. Werkst. Werkz. messen Position Planfräsen Schwenken

TECHNICAL APPENDIX

Drilling from the solid

Application notes _____	
TTD-Tritan replaceable head drill _____	740
Deep drilling _____	742
Indexable insert drills _____	744
Instructions for use _____	
QTD indexable insert drill _____	746
TTD replaceable head drill _____	748
TTD-Tritan replaceable head drill _____	750

Reaming and fine boring

Lead geometries and rake angles _____	752
Instructions for use	
HFS system _____	754
HPR400 and HPR400 plus _____	756
Single-bladed reamers _____	758
EasyAdjust system _____	760
Troubleshooting _____	764

Boring and turning

Terminology and formulae _____	766
Guide values for the minimum boring diameter _____	770
Troubleshooting	
Forms of wear and tear on indexable inserts _____	772
Inspired by practical applications, designed for practical applications	773

Application notes for TTD-Tritan replaceable head drills

The triple-edge TTD-Tritan replaceable head drill guarantees optimal torque transmission at the connection and high changeover and radial run-out accuracy at the same time. The replaceable head can be changed quickly and reliably. Incorrect positioning is impossible. A suitable TORX® wrench with a handle is included with the tool to clamp the replaceable head to the replaceable head holder precisely via the special clamping screw.

Coolant situation:

Coolant pressure as a function of the drilling depth: 3xD: 8 bar | 5xD: 12 bar



Maximum entry and outlet angle:

When spot drilling and at the outlet from inclined surfaces, reduce v_f by 50%.

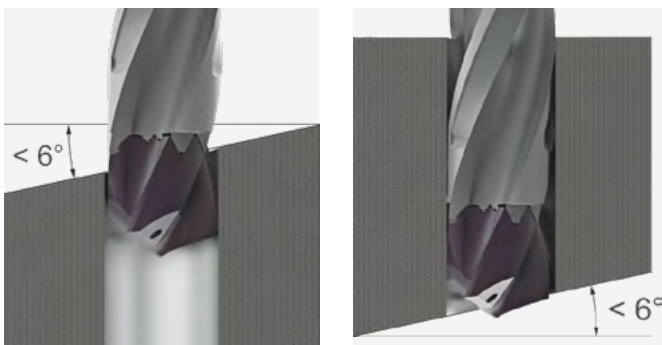

Through hole:

Do not reduce the cutting data at the bore outlet.

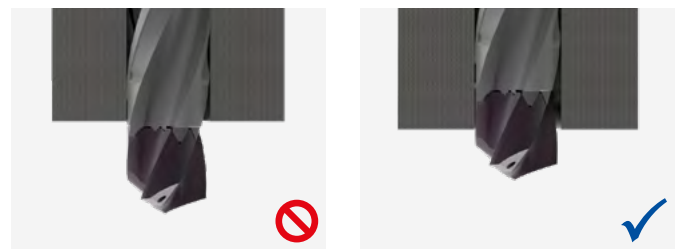

Radial run-out accuracy:

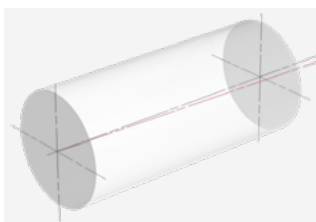

Max. 0.02 mm

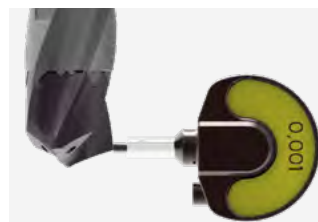

Max. 0.04 mm

No rapid traverse on withdrawal:

Five times the feed rate is recommended for the withdrawal speed.

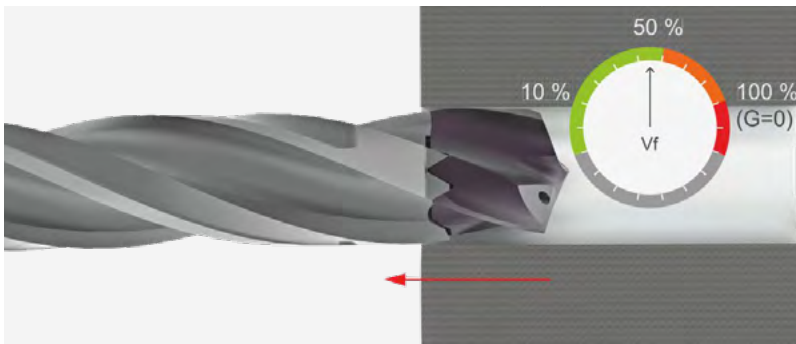

Machining situations:



Bore eccentric;
chisel edge cutting

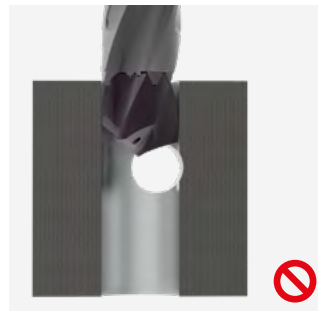

Bore eccentric;
chisel edge not cutting

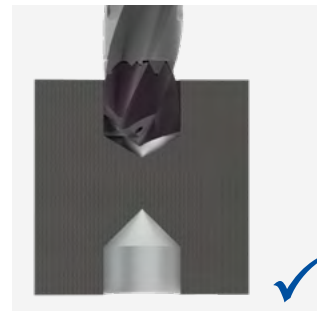

Breakthrough to bore in opposite direction;
 $v_f = -50\%$

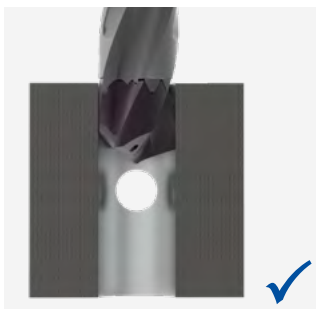

Bore centred and $\ll D$



Bore centred and $\approx D$

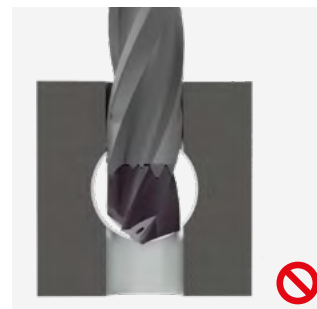

Bore centred and $\gg D$

Deep drilling

For MEGA-Deep-Drill | MEGA-Deep-Drill-Alu

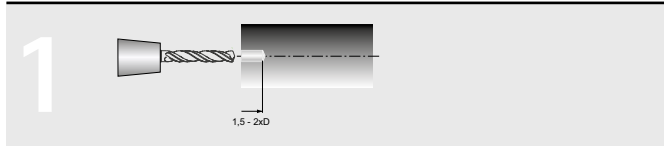

Making a pilot bore

- Recommendation for spotting drill, see following page (or 0,01 - 0,02 mm larger as the deep drill diameter)
- Pilot bore depth between 1.5 and 2xD

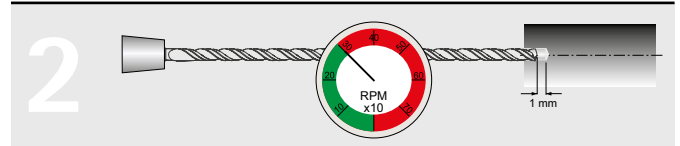

MEGA-Deep-Drill – entry into the pilot bore

- Entry at max. 300 min⁻¹ and v_f = 1000 mm/min
- Without coolant – up to 1 mm before the bottom of the pilot bore
- Turn on coolant

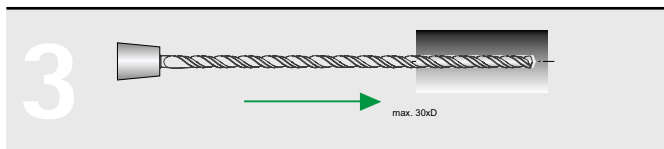

Drilling using a MEGA-Deep-Drill

- Cutting speed (v_c) and feed rate (f) according to table (see page 286). Drill without chip removal cycles

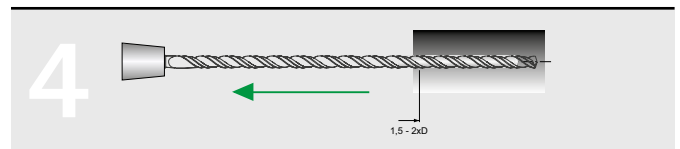

MEGA-Deep-Drill – moving back

- Move back at current spindle speed and double the feed (= 2 x v_f) to 1.5 – 2xD until you reach the end of the bore

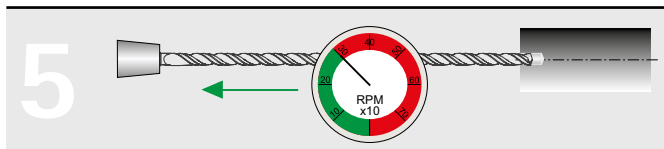

MEGA-Deep-Drill – run out of the bore

- Switch off coolant
- Run out at max. 300 min⁻¹ and v_f = 1,000 mm/min

Application instructions for diameter ≤ 3 mm:

- Select a coolant type suitable for small tools for optimum cooling lubrication
- Effective filtration of the cooling medium prevents the cooling channels from becoming clogged up
- Select a suitable drilling cycle (drilling with chip removal cycles if necessary)

Coolant pressure required

For MEGA-Deep-Drill | MEGA-Deep-Drill-Alu

	ø 3 – 5 mm	ø 5 – 8 mm	ø 8 – 12 mm	ø 12 – 16 mm
IC	60 bar	40 bar	30 bar	25 bar
MQL	12 bar	10 bar	9 bar	8 bar

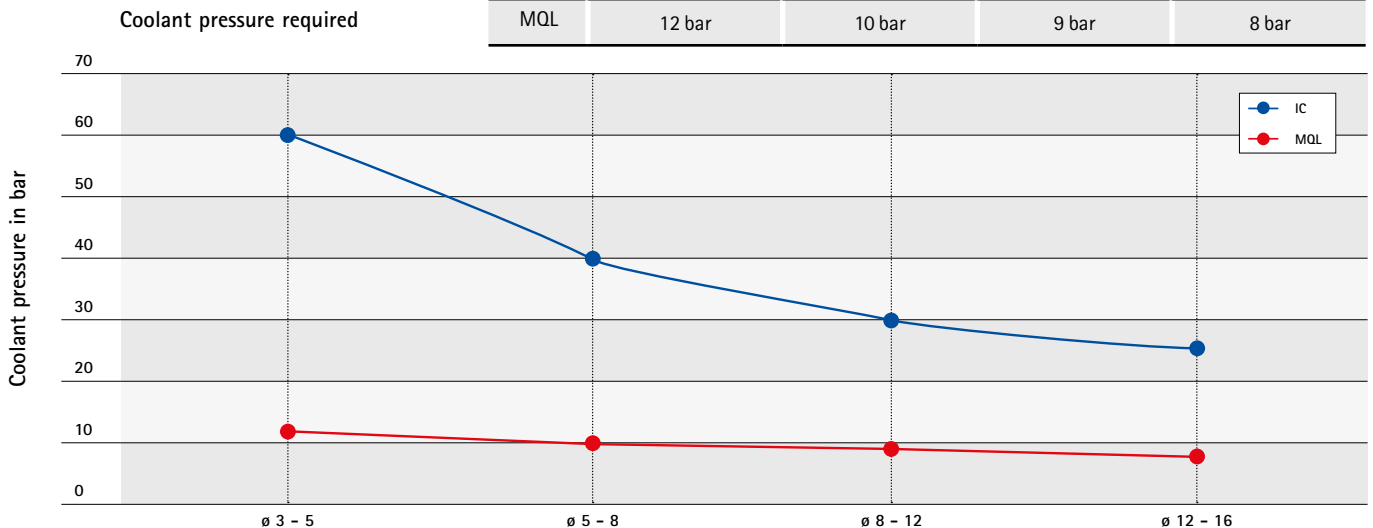

Deep drilling 15xD – 30xD in two steps:

Deep drilling 15xD – 30xD with MEGA-Deep-Drill (SCD171) and/or MEGA-Deep-Drill-Alu (SCD181)

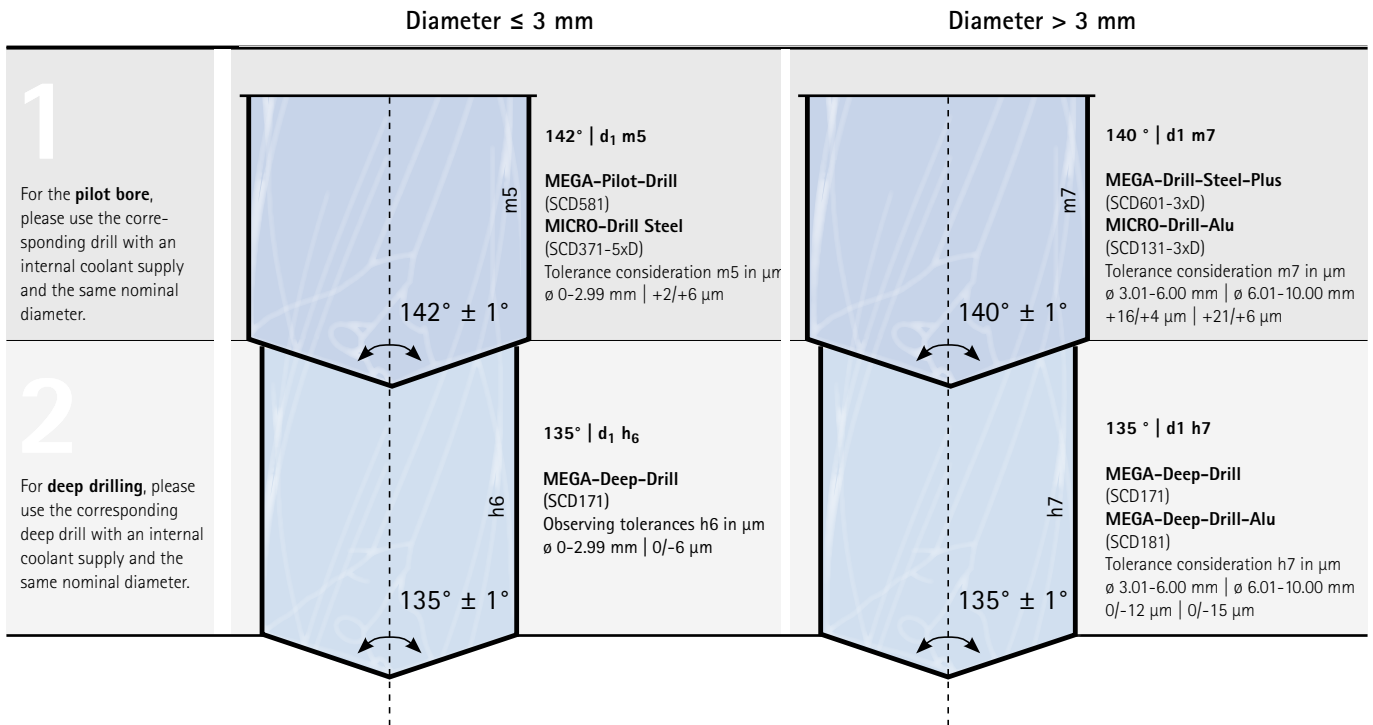

Deep drilling 40xD in three steps:

Deep drilling 40xD with MEGA-Deep-Drill (SCD171) and/or MEGA-Deep-Drill-Alu (SCD181)

Optimally designed for reliable machining.

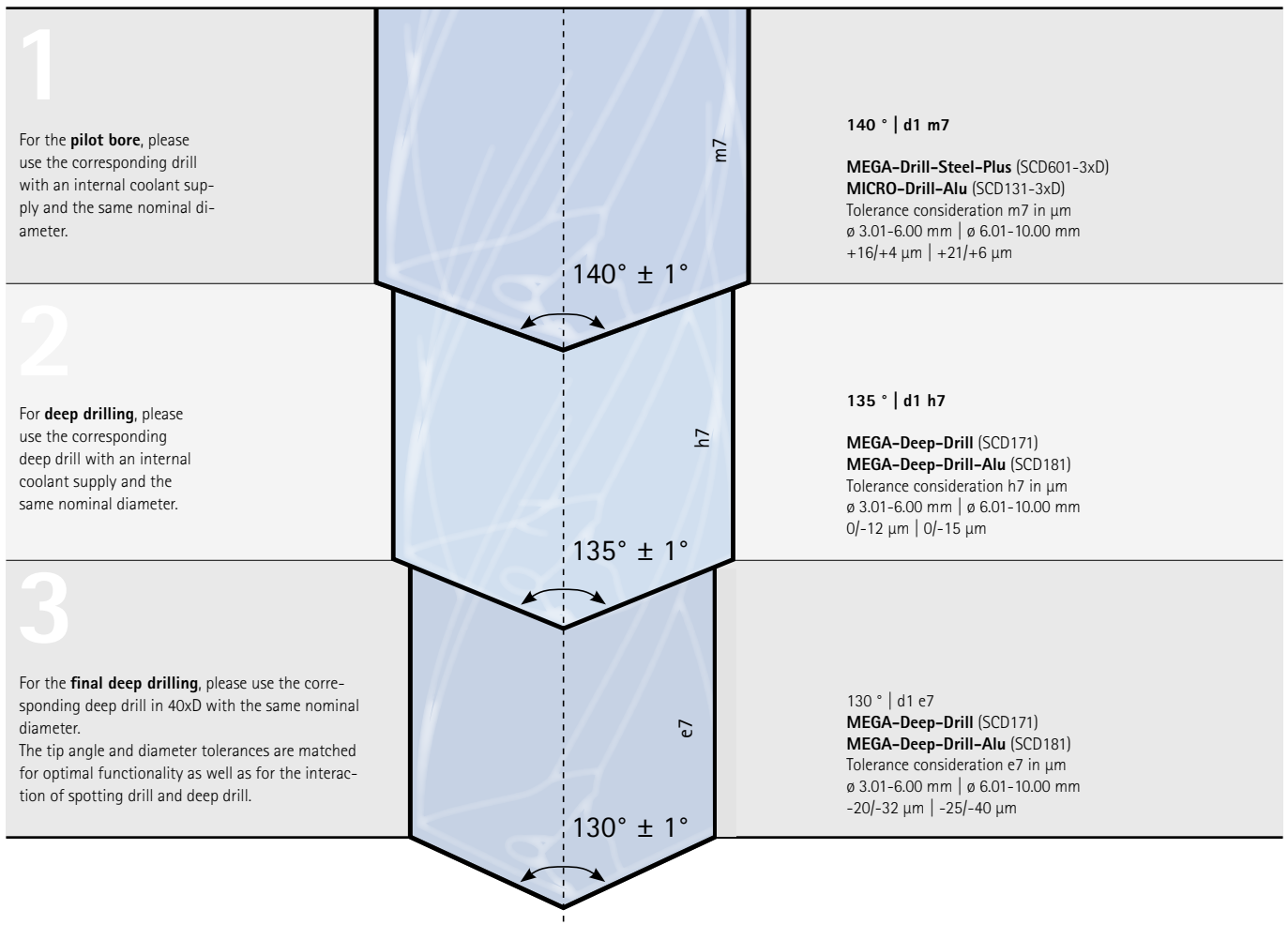

Application notes for indexable insert drills

NOTES

- Maximum tool length 5xD
- When using drills with a length/diameter ratio of more than three, the following reductions are recommended during spot drilling as well as during drill exit in relation to the cutting speed v_c and feed f :
 - 3xD: v_c -20 % | f -30 %
 - 4xD: v_c -30 % | f -40 %
 - 5xD: v_c -40 % | f -50 %



Ideally, the drilling situation is flat, countersunk or pre-milled.

If this is not the case, a feed reduction of 30 to 60 per cent is necessary in the following cases:

- Spot drilling and drill outlet on inclined and concave surfaces
- Bore entry into cross bores
- Stack bores
- Spot drilling on uneven surfaces
- Spot drilling on an edge
- Spot drilling on a spherical surface
- Spot drilling on a pointed contour
- Series of bores with overlaps
- Spot drilling a centring
- Boring not possible



Stack bores

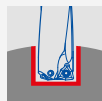

Spot drilling on a spherical surface



Through drilling with cross bore



Spot drilling on a pointed contour



Spot drilling on uneven surface

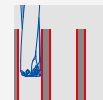

Series of bores are possible to a limited extent depending on the material



Spot drilling on an edge



Spot drilling a centring or recess bore



Spot drilling inclined surfaces / inclined bore outlet



Boring not possible

Topography at the bottom of the bore for blind bores

	Diameter D [mm]	A* [mm]	B* [mm]	C* [mm]
WOGT030206N-X40-HC698	16.00 - 20.90	3.61 (at \varnothing 16) - 3.52 (at \varnothing 20.9)	3.89 (at \varnothing 16) - 6.93 (at \varnothing 20.9)	0.40 (at \varnothing 16) - 0.71 (at \varnothing 20.9)
WOGT040206N-X40-HC698	21.00 - 25.90	4.06 (at \varnothing 21) - 4.00 (at \varnothing 25.9)	6.44 (at \varnothing 21) - 8.95 (at \varnothing 25.9)	0.76 (at \varnothing 21) - 0.98 (at \varnothing 25.9)
WOGT053006N-X40-HC698	26.00 - 30.90	5.18 (at \varnothing 26) - 5.11 (at \varnothing 30.9)	7.82 (at \varnothing 26) - 10.34 (at \varnothing 30.9)	0.81 (at \varnothing 26) - 1.04 (at \varnothing 30.9)
WOGT063008N-X40-HC698	31.00 - 44.90	6.41 (at \varnothing 31) - 6.28 (at \varnothing 44.9)	9.09 (at \varnothing 31) - 16.18 (at \varnothing 44.9)	1.06 (at \varnothing 31) - 1.62 (at \varnothing 44.9)
WOGT073808N-X40-HC698	45.00 - 54.90	7.70 (at \varnothing 45) - 7.63 (at \varnothing 54.9)	14.80 (at \varnothing 45) - 19.82 (at \varnothing 54.9)	1.57 (at \varnothing 45) - 7.63 (at \varnothing 54.9)

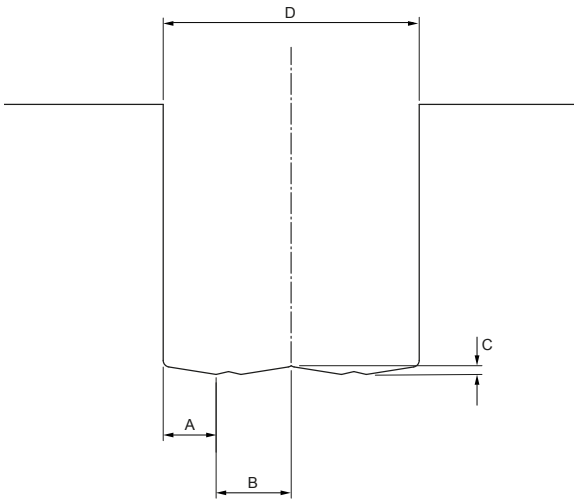
**Safety instruction:**

When drilling through bores, a sharp-edged bore cover or disc falls off as the drill leaves the bore. There is a danger that this disc will be thrown off and cause damage or injuries. To prevent this situation arising, appropriate safety precautions are to be taken.

* A, B and C vary due to the installation position and contact angle of the indexable inserts.

Instructions for using the QTD indexable insert drill

Easily changed and set of the QTD cutting edge

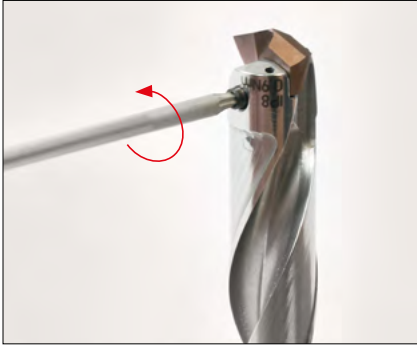

1. Undo the special clamping screw using the supplied TORX® PLUS wrench by turning it anticlockwise.



2. Remove the indexable insert from the insert seat.



3. Clean the insert seat using compressed air.

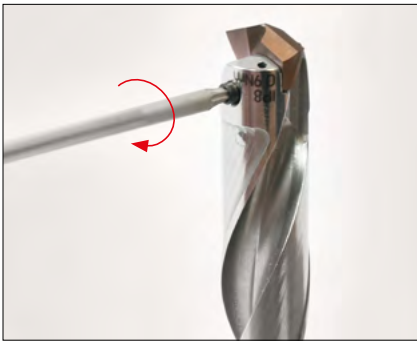

4. Fit the new indexable insert in the insert seat. Hand tighten the special clamping screw using the supplied TORX® PLUS wrench by turning it clockwise.



5. Tighten the special clamping screw to the specified tightening torque.

NOTES

- Use original screws only!
- The special clamping screw must be replaced upon the 5th drill head change at the latest
- The applicable tightening torque is printed on the tool

Result:

The indexable insert has now been successfully changed and the tool can be used.

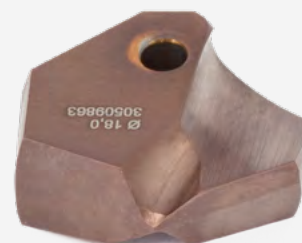

Instructions for using the TTD replaceable head drill

Practical notes

PILOTING

- A pilot bore is recommended for drilling depths $\geq 8xD$
- For type O2 replaceable drill heads, a pilot bore is recommended for drilling depth $\geq 5xD$
- For a pilot bore with type O2 replaceable drill heads, a reduction of the feed stated by 50% is recommended
- For a pilot bore with type O1 and type O3 replaceable drill heads, the recommended machining values can be used
- Drill into the pilot bore with the same drill head geometry and reduced machining values (recommendation: $v_c = 50\%$ and approx. $f = 50\%$) up to 1 mm before the bottom of the bore
- Drilling after piloting is then undertaken using the recommended machining values (see pages 224–227)

NOTES ON DRILLING USING 12xD TOOL HOLDERS

- At a drilling depth of 12xD a pilot bore is necessary
- Coolant pressure must be at least 40 bar
- During the machining of steel materials, chip removal may be necessary
- Usage on a lathe is possible with a powered tool
- Increasing the cutting speed by 30% over the standard value is recommended

Stationary tool

If the tool is stationary, position the chip space runout horizontally so that chip congestion does not occur.

Through bore

Do not reduce the cutting data at the bore outlet.

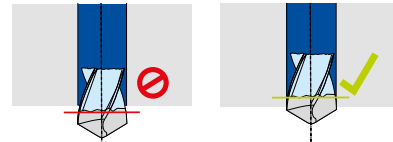

Coolant situation

Coolant pressure as a function of the drilling depth:

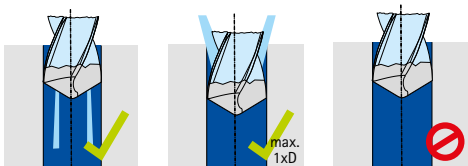

1xD: 8 bar | 3xD: 8 bar | 5xD: 12 bar | 8xD: 25 bar | 12xD: 40 bar

Radial run-out accuracy

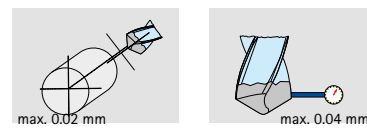

Max. entry and exit angle

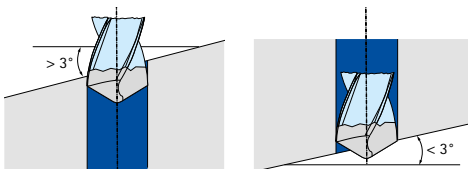

No rapid traverse on withdrawal

Five times the feed speed is recommended for the withdrawal speed.

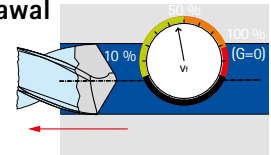

Machining situations

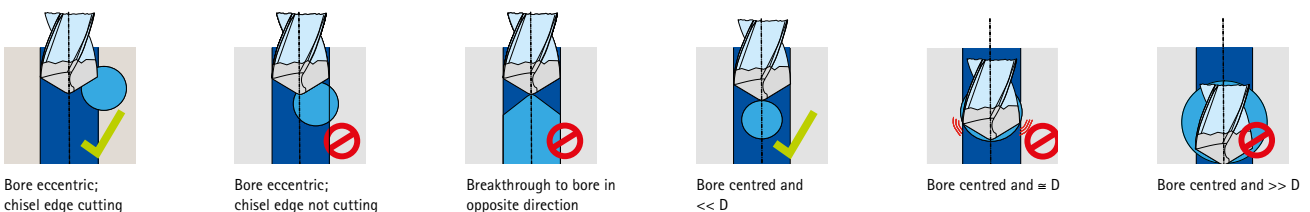

Assembly

Undoing the drill head

1. Whenever the drill head is changed, check that the clamping screw is tight. If the clamping screw can be undone easily, the clamping screw must be replaced. Only use the original clamping screws!

Note:

At the latest on the 8th drill head change, the clamping screw must be replaced.



2. Undo the clamping screw with the aid of the supplied hex-wrench.



3. Pull the drill head out of the serration.

Clamping the drill head



1. Clean the TTS connection on the tool holder with a brush.

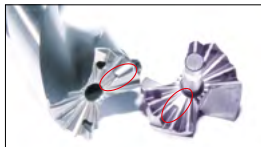

2. Fit the new drill head to the tool holder.



3. Hand tighten the clamping screw clockwise.

Note:

Ensure the positioning aid on the drill head is engaged in the positioning aid on the tool holder and that the chip flute and serration on the drill head and tool holder are aligned.

Tightening torques of the clamping screw

Diameter range [mm]	Thread interchangeable head holder	Spanner width sw	Permissible transmissible Tightening torque [Nm]
12,00 - 13,49	M2,5	1,3	1,0
13,50 - 16,49	M3	1,5	1,3
16,50 - 24,49	M4x0,5	2	3,5
24,50 - 32,49	M5x0,5	2,5	4,0
32,50 - 41,49	M6x0,5	3	6,0
41,50 - 45,49	M8x1	4	10,0

Instructions for using the TTD-Tritan replaceable head drill

Tool assembly

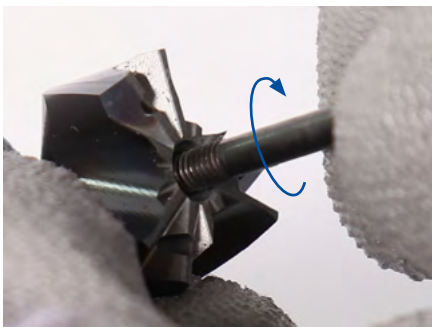

1. Insert and tighten the special clamping screw

Fit the special clamping screw into the bore on the replaceable drill head with the small thread end facing forward. Then screw in the special clamping screw clockwise to the stop.



2. Clean with compressed air

Clean the replaceable head holder and replaceable drill head using compressed air.

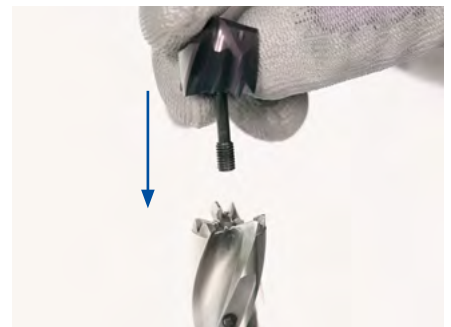

3. Fitting the replaceable drill head

Fit the replaceable drill head onto the replaceable head holder.

Note:

The special clamping screw is already installed on the replaceable drill head on delivery. If removed, the special clamping screw can be attached to the replaceable drill head again by screwing it in.

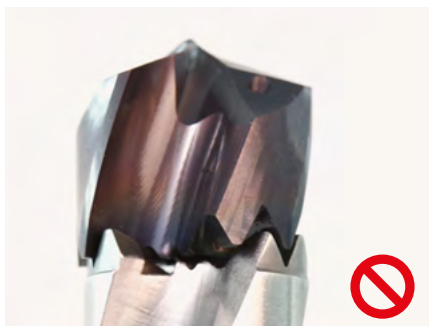
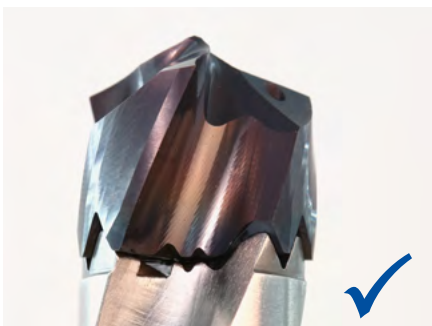

4. Check positioning of the drill head

Check whether chip flute and serrations of replaceable drill head and replaceable head holder are aligned. If they are not aligned, turn the replaceable drill head until chip flute and serrations are aligned.

Result:

Chip flute and serrations are aligned (left) | are not aligned (right)



- 1 Handle for TORX® wrench
- 2 TTS replaceable head holder
- 3 TORX® wrench
- 4 Replaceable drill head with special clamping screw

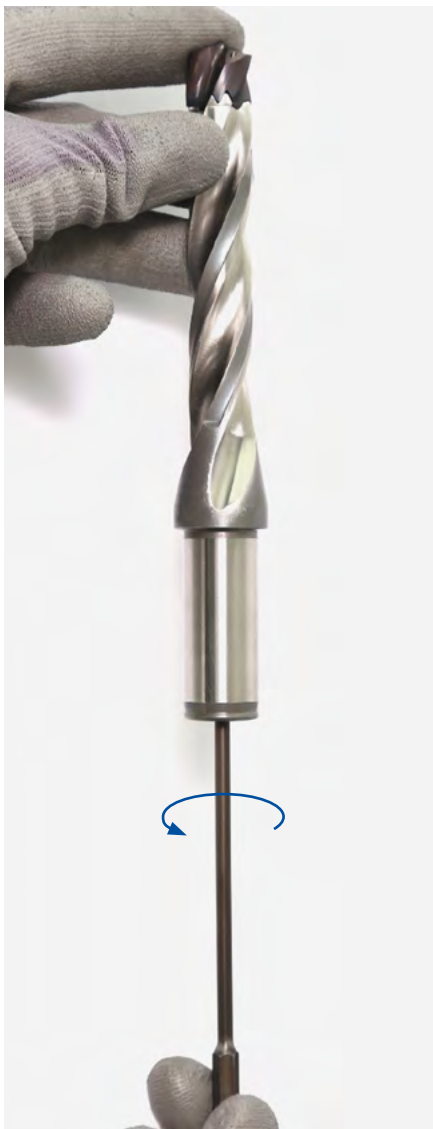

5. Tighten the special clamping screw up to the stop. Hold the replaceable drill head lightly against the replaceable head holder so that it maintains its fitted position. Then insert the TORX® wrench in the central bore of the replaceable head holder to the threaded bore of the special clamping screw. Hand tighten the special clamping screw using the TORX® wrench by turning it anticlockwise to the stop.



6. Tighten the special clamping screw to the prescribed tightening torque

Using a suitable torque wrench with internal hexagon bit in combination with the TORX® wrench, tighten the special clamping screw to the stipulated tightening torque.

Note:

The stipulated tightening torque for the special clamping screw is noted on the bottom of the replaceable head holder.

Result:

The special clamping screw is tightened to the specified tightening torque and the replaceable drill head is securely connected to the replaceable head holder. Installation is complete.

Scope of delivery:

- 1 Handle for TORX® wrench
- 2 TTS replaceable head holder
- 3 TORX® wrench

Tightening torques for the special clamping screw

Diameter range [mm]	Thread of replaceable head holder	TORX® size	Permissible transferable tightening torque [Nm]
12,00 - 13,99	M3 x 0,5	T6	0,40
14,00 - 17,49	M3,5 x 0,6	T7	0,70
17,50 - 19,49	M4 x 0,7	T8	1,30
19,50 - 24,49	M5 x 0,8	T10	2,00
24,50 - 28,49	M6 x 1,0	T15	3,10
28,50 - 32,49	M6 x 1,0	T15	5,60

Lead geometries and rake angles

Multi-bladed reamers

Series FXR, MOR, MPR, HPR

Lead

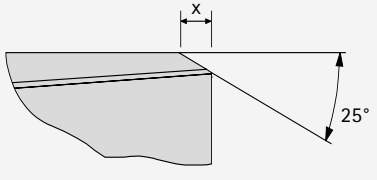
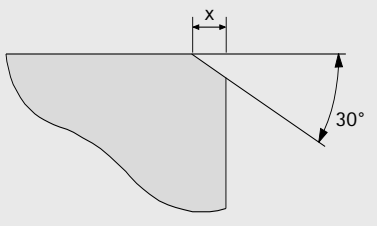
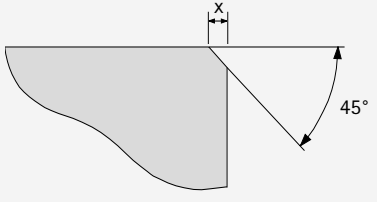
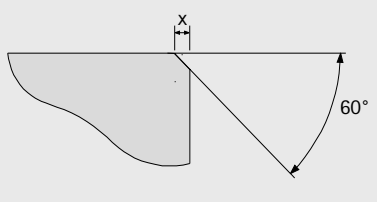
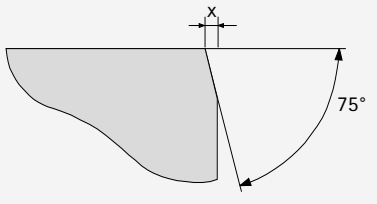
Geometry	Lead geometry	
	Name	Geometry
	ML	25°
	ME	30°
	MF	
	MG	
	MY	
	MC	45°
	MO	
	MU	
	MV	60°
	MT	
	MA	75°

Chip shape / rake angle

Rake angle	
Name	Angle
0A	0°
1 F	5°
1G	6°
1M	13°
2A	0° (for blind bore)
2G	6° (for blind bore)
3C	-2°

Cutting material definition	
Name	Type
HU	Carbide uncoated
HP	Carbide PVD-coated
HC	Carbide CVD-coated
CU	Cermet uncoated
CP	Cermet PVD-coated
PU	PCD

x = lead length

Series overview | diameter range | lead designation | lead length

Series	Lead designation	Diameter range	Lead length x
FXR	MC	2,81 - 3,35	0,30
		3,36 - 4,05	0,40
		4,06 - 5,60	0,50
		5,61 - 6,60	0,60
		6,61 - 7,60	0,70
		7,61 - 11,60	0,80
		11,61 - 20,10	1,00
	MF	2,81 - 3,70	0,70
		3,71 - 6,20	0,90
		6,21 - 12,20	1,20
		12,21 - 20,20	1,50
	MG	2,81 - 3,70	0,70
		3,71 - 6,20	0,90
		6,21 - 12,20	1,20
		12,21 - 20,20	1,50
	MT	2,81 - 6,20	0,30
		6,21 - 10,70	0,40
		10,71 - 16,20	0,50
		16,21 - 20,20	0,60
	MV	2,81 - 6,20	0,30
		6,21 - 10,70	0,40
		10,71 - 16,20	0,50
		16,21 - 20,20	0,60

Series	Lead designation	Diameter range	Lead length x
MOR	MY	7,70 - 40,20	1,00
	MU	7,70 - 40,20	0,60
MRP	MG	3,85 - 6,20	0,90
		6,21 - 10,70	1,20
		10,71 - 20,20	1,50
		20,21 - 40,20	1,50
	MV	3,85 - 6,20	0,30
		6,21 - 10,70	0,40
		10,71 - 20,20	0,50
		20,21 - 26,20	0,60
	26,21 - 40,20	0,80	
HPR	MA	7,00 - 65,00	0,40
	MC	7,00 - 65,00	0,55
	ME	7,00 - 65,00	1,40
	MF	7,00 - 65,00	1,40
	ML	7,00 - 65,00	1,00
	MO	7,00 - 65,00	0,60

Instructions for using the HFS® system

MAPAL HFS® system with axial clamping

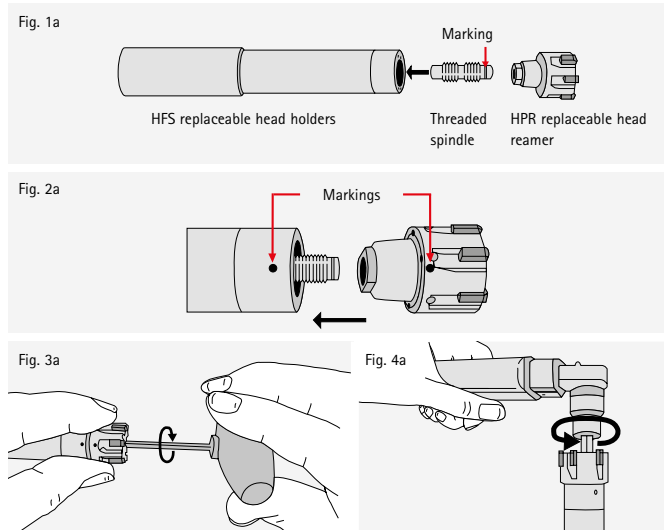

MAPAL HFS® system with radial clamping

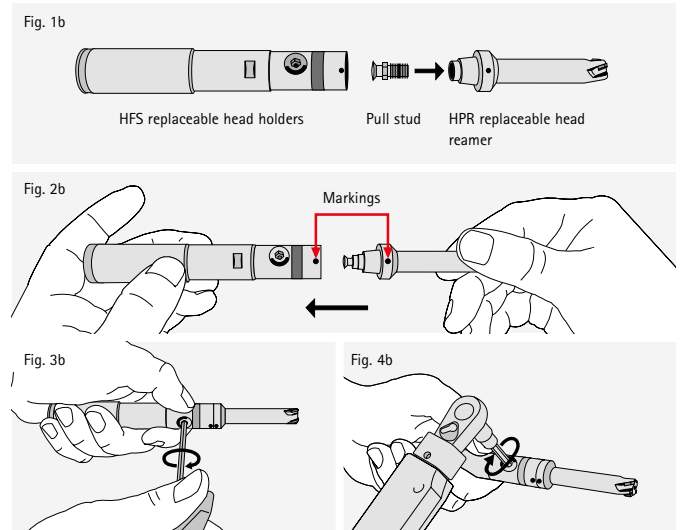

Cleaning

Clean all individual parts and make sure that the internal and external taper as well as the face surface on the HFS taper are free of foreign bodies (e.g. chips). To clean the internal taper, we recommend the special taper wiper (see page 474).

Clamping

- Fit the end of the threaded spindle without marking into the HFS replaceable head holder, without screwing in the threaded spindle (see Fig. 1a).
- Place the HPR replaceable head reamer onto the threaded spindle. In doing so, align the markings on the HPR replaceable head reamer and the HFS replaceable head holder "point to point" (see Fig. 2a). Then fit the HPR replaceable head reamer all the way into the HFS replaceable head holder and hold both parts firmly.
- Screw together the HPR replaceable head reamer and the HFS replaceable head holder using a hex-wrench and tighten firmly. Make sure that the markings are aligned and the face surface touches (see Fig. 3a).
Note: HPR 100, 110, 150 are tightened through the reamer (direction of rotation clockwise). HPR 130, 131, 180 are tightened through the tool holder (direction of rotation anticlockwise). The directions of rotation are stated on the tool holder.
- Note:** The HFS replaceable head holders are labelled with the necessary tightening torque. Tighten the HPR replaceable head reamer clockwise using a torque wrench (see Fig. 4a).

Undoing

- Note:** The direction of rotation to undo the HPR replaceable head reamer is opposite to the direction of rotation for the clamping process. To undo the HPR replaceable head reamer, turn the threaded spindle using a hex-wrench.
- Remove the HPR replaceable head reamer.

Adjusting the HPR replaceable head reamer with fine adjustment feature

- Note:** The opposite pair of cutting edges directly above the round marking points on the HFS replaceable head holder and HPR replaceable head reamer serves as a reference for measuring and adjusting the tool diameter. Fasten the HPR replaceable head reamer in the HFS replaceable head holder.
- Set the desired tool diameter by means of the vernier micrometer. Then place the vernier micrometer against the reference blades.
- Place the TORX® wrench on the adjusting screw and slowly turn it clockwise. Set the HPR replaceable head reamer to the desired dimension.

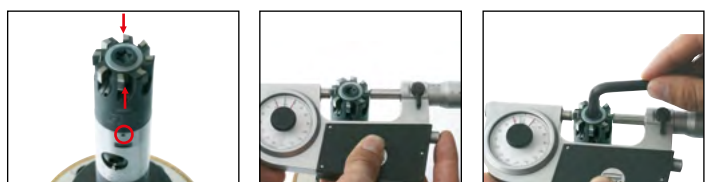

Please note for HPR variants with adjustment system:

For fine-adjustable HPR replaceable head reamers up to \varnothing 30 mm and HFS size 12 to 20, the HPR replaceable head reamer can only be clamped radially. From \varnothing 30 mm and HFS size 24, the HPR replaceable head reamer can also be clamped via the threaded spindle.

Clamping

- Screw the threaded end of the pull stud into the HPR replaceable head reamer using the left-hand thread (see Fig. 1b).
- Fit the HPR replaceable head reamer all the way into the HFS replaceable head holder. In doing so, align the markings on the HPR replaceable head reamer and the HFS replaceable head holder "point to point" (see Fig. 2b). Then hold both parts firmly.
- Turn the clamping stud clockwise using a hex-wrench (see Fig. 3b). The direction of rotation is stated on the HFS replaceable head holders.
- Note:** The HFS replaceable head holders are labelled with the necessary tightening torque. Tighten the HPR replaceable head reamer clockwise using a torque wrench (see Fig. 4b).

Connection size HFS	Tightening torque [Nm]	
	Axial	Radial
10	4	-
12	6	7
14	6	7
16	15	12
20	15	12
24	20	-

Undoing

- To undo the reamer, turn the clamping stud anticlockwise to the stop using a hex-wrench.
→ The HPR replaceable head reamer is ejected and can be removed.

Coolant supply for the HFS[®] system

To fully exploit the high performance of the HPR reamers, the different series of replaceable heads each require the appropriate coolant supply. The difference in the parts lies in the threaded spindle or the pull studs. Depending on the head variant, these are used with coolant through-bore or without coolant through-bore, so that a direct coolant supply is ensured via the connection head directly to the cutting edges.

For all tool holders with HFS size 12, both designs are always included in the scope of delivery. When mounting, care must therefore be taken to select the system that matches the replaceable head. (see Fig. below)

Note:

Coolant supply without central through-bore

The reamers must be mounted without a central coolant through-bore. The coolant is transferred from the tool holder to the replaceable head via the face surface.

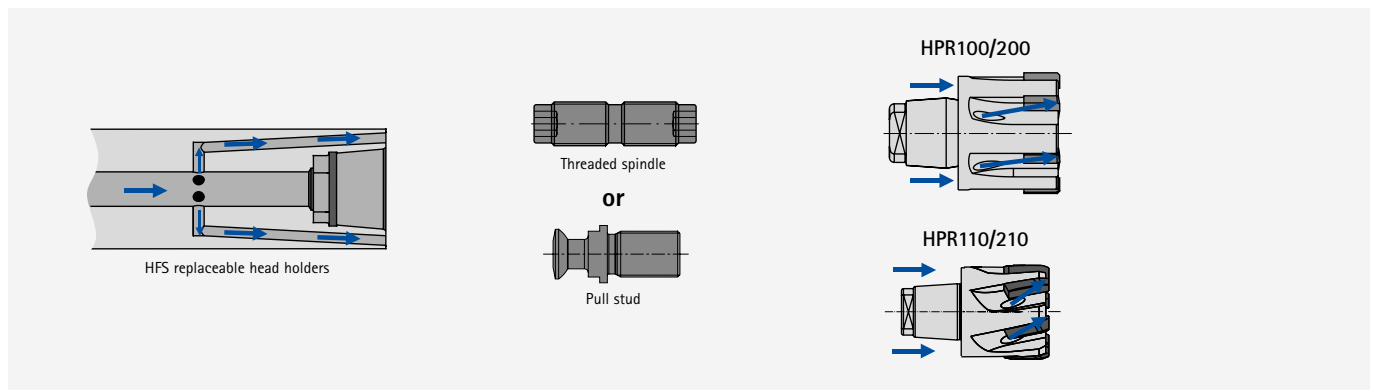

Coolant supply with central through-bore

All the listed reamers must be mounted with a central coolant through-bore. The coolant is transferred centrally and, in the case of the HPR150 and HPR250, additionally via the face surface.

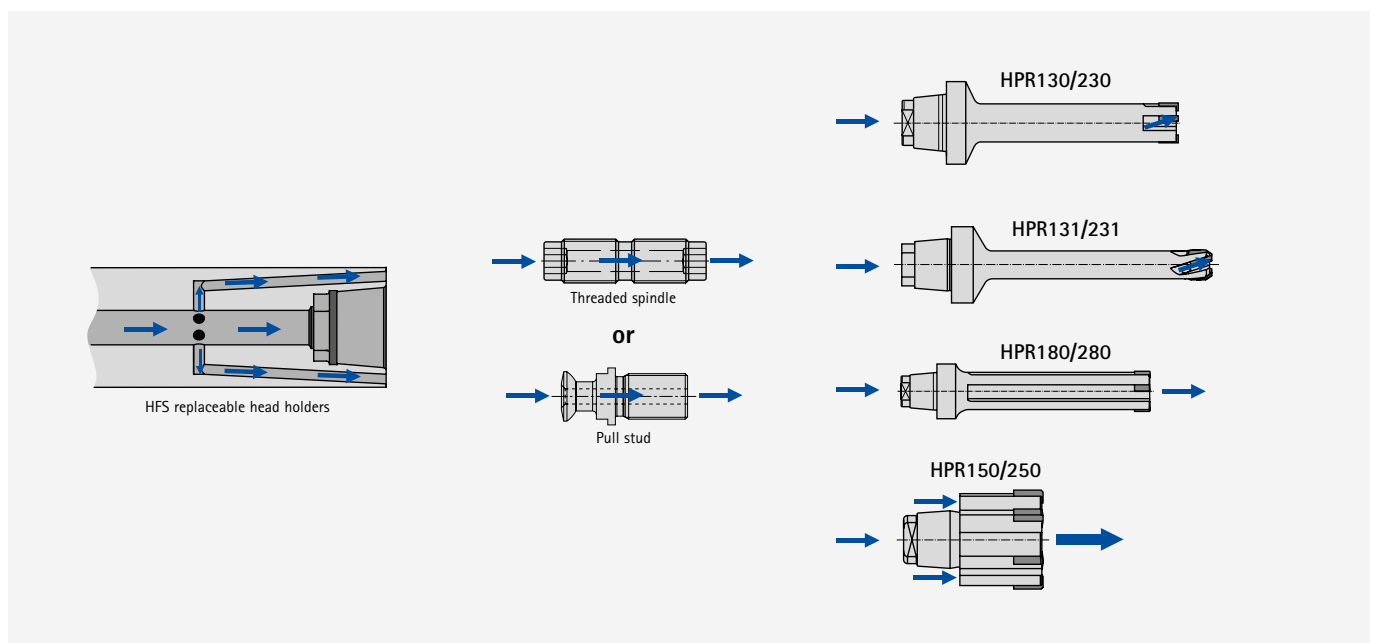

Instructions for using the HPR400

The HPR400 offers a system where the tool can be reloaded quickly and economically directly at the customer's site. The replaceable indexable inserts are pushed axially into the insert seat and fixed stably in the tool body with a TORX® screw. The usual μm -accurate machining quality is always maintained.

Changing the indexable inserts

Note:

When changing the indexable inserts, all indexable inserts must always be completely changed!



1. Clean the HPR400 with compressed air and a cloth. Loosen the TORX® screw by turning it anticlockwise with a suitable TORX® screwdriver. After loosening, remove the TORX® screw.



2. Carefully push the indexable insert up out of the insert seat in the axial direction and remove. Remove the remaining indexable inserts by repeating steps 1 and 2.

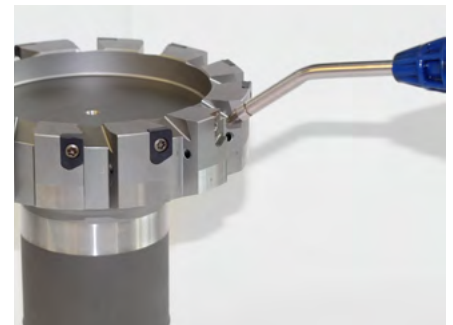

Comment:

For trained personnel only.

3. **Note:** Clean the contact surfaces of the indexable inserts if they are dirty.

Clean the insert seats using compressed air. Then clean the insert seats properly using alcohol.



4. Fit the new indexable insert half-way into the insert seat. Then press the indexable insert gently into the insert seat using your thumb and at the same time push the insert axially downward into the end position. To prevent the indexable insert from falling out, fix the indexable insert with the TORX® screw.



5. **Note:** Only tighten the TORX® screws using a suitable torque wrench.

Tighten the TORX® screws to a tightening torque of 3.1 Nm.

Result:

The indexable inserts have been completely changed and the HPR400 is ready for use.

Instructions for using the HPR400 plus

The four-edged indexable inserts on the HPR400 plus are manufactured so accurately that they can be rotated or changed on site by the customer's staff without problems.



Changing the indexable inserts

Requirements:

Clean the tool before starting to change the indexable inserts.

Comment:

For trained personnel only.



1. Undo the TORX® PLUS screw using a suitable screwdriver. To do this, turn the TORX® PLUS screw anticlockwise. Then remove the TORX® PLUS screw.



2. Carefully push the indexable insert up out of the insert seat in the axial direction and remove. Remove the remaining indexable inserts.



3. Clean the insert seats using compressed air and clean the insert seats properly using alcohol. Clean the contact surfaces of the indexable inserts using cleaning compound.

Note:

When changing the inserts, all indexable inserts must be rotated or changed!



Note:

When rotating the indexable insert, pay attention to the cutting edge sequence with the aid of the marking points (one to four points).



4. Fit the new or rotated indexable insert half-way into the insert seat. Then press the indexable insert gently into the insert seat using your thumb and at the same time push the insert axially downward into the insert seat. Then fix the indexable insert using the TORX® PLUS screw.



5. Tighten TORX® PLUS screw clockwise to the stipulated tightening torque.

Note:

Only tighten the TORX® PLUS screws using a suitable torque wrench. The tightening torque for TORX® PLUS screws is 3.5 Nm.

Result:

The indexable inserts have been completely changed and the tool is ready for use.

Adjustment instructions for WP single bladed reamers

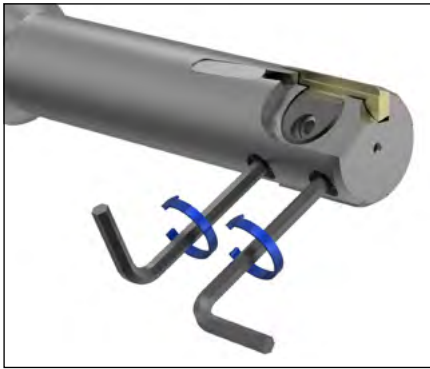
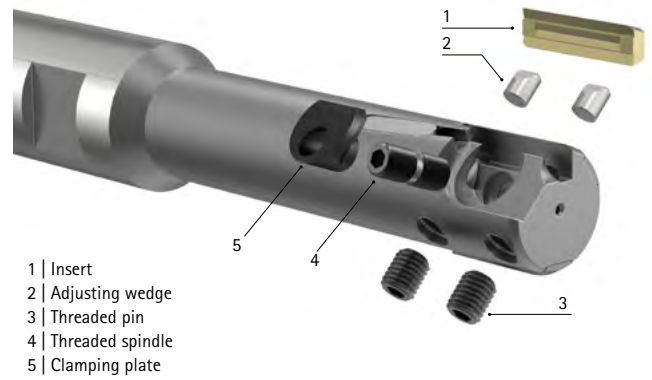

1. Turn both threaded pins ½ turn anticlockwise.



2. Loosen clamping plate:
Turn the threaded spindle anticlockwise by 2-3 turns from both sides (insert points downward).

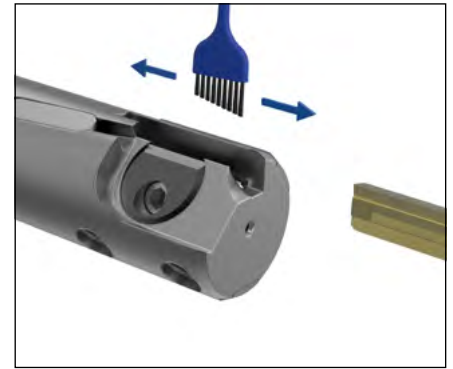

3. Remove the insert.

4. Clean insert und insert seat.

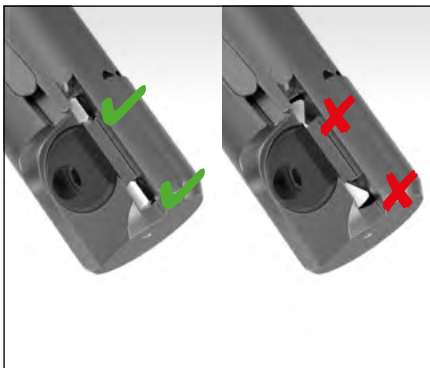

5. Ensure that the adjusting wedges are positioned straight.

6. Fit the new or rotated insert into the insert seat.

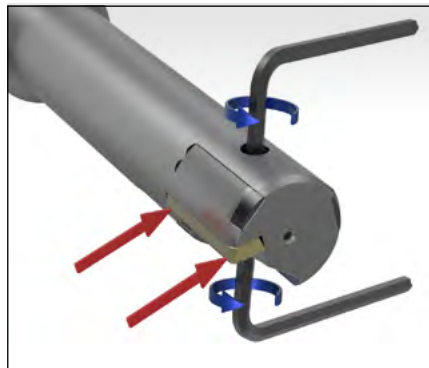

7. Hold down the insert and tighten the threaded spindle clockwise from both sides to the required tightening torque.

8. Turn both threaded pins ¼ turn clockwise.

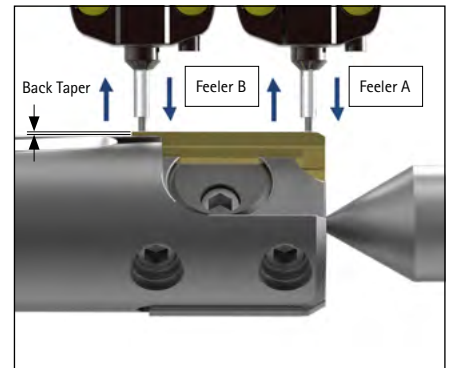

9. Adjust the front and rear setting dimensions at alternating intervals using the threaded pins. Back taper to the rear approx. 1 µm/mm.

NOTE:

An overview of the tightening torques in PDF format can be found on the MAPAL website:

www.mapal.com → Media → Manuals and instructions → General technical information → Tightening torque for MAPAL clamping screws

Adjustment instructions for HX single-bladed reamers

Size 2 and size 3

- | | |
|----------------------|---------------------|
| 1 Clamping plate | 4 Cassette |
| 2 Threaded spindle | 5 Adjusting wedge |
| 3 HX blades | 6 Threaded pin |

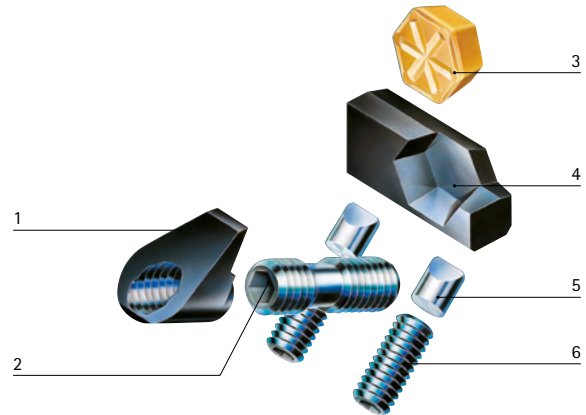

Indexable insert change and setting

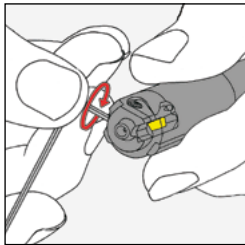

1. Turn the front and rear threaded pin half a turn to the left.

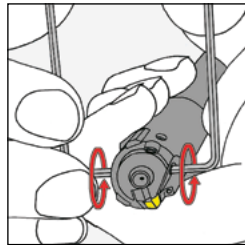

2. **Note:** Two wrenches must be used for opening. To loosen the clamping plate and the cassette, turn the threaded spindle clockwise and anticlockwise.

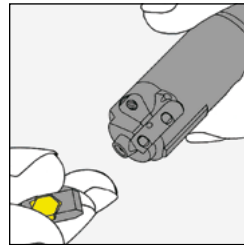

3. Remove the insert and the cassette. Clean the insert, the cassette and the insert seat (do not use compressed air, mind the adjusting wedge). Turn the insert 60° or insert a new insert into the cassette. Reinstall the cassette.

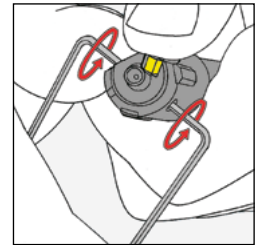

4. **Note:** Two wrenches must be used for tightening. Press the insert and the cassette against the back stop and the adjusting wedge. Turn the threaded spindle from the top to the right and from the bottom to the left and tighten them.

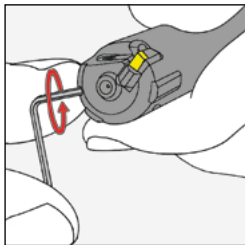

5. For coarse setting, turn the front and rear threaded pin a quarter turn to the right.

For the simplest handling and guaranteed reliable setting, we recommend using a MAPAL setting fixture.

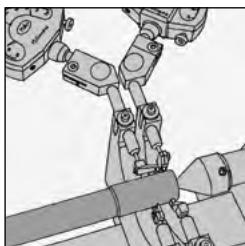

7. Calibrate the MAPAL MASTERSET with setting gauge (must be ordered separately). The setting gauge has the minimum size of the bore.

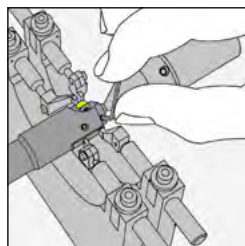

8. Adjust the front and rear setting dimensions at alternating intervals using the threaded pins. The back taper to the rear is approx. 0.005 to 0.010 mm.

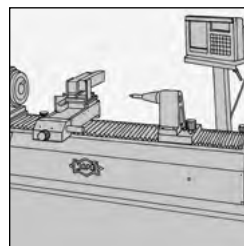

9. MAPAL UNISET: MAPAL offers electronic setting fixtures in vertical and horizontal designs to conveniently set reamers. You can find more information in the catalogue "SETTING | MEASURING | DISPENSING".

For detailed setting instructions, see the operating manual for the fixture.

Instructions for using the EasyAdjust system

Replacing and setting the insert

The EasyAdjust system permits quick and easy indexable insert changes. The inserts are replaced and set with μ precision in just a few steps.



1. Loosen the adjusting wedge using a hex-wrench and turn it half a turn anticlockwise.

Comment:

Only to be used by trained personnel.

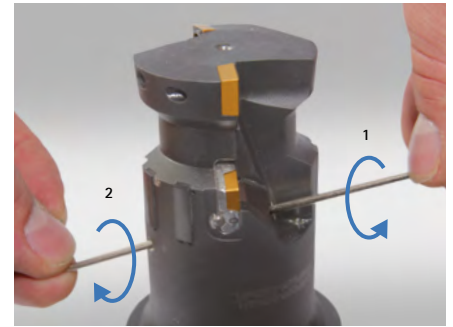

2 **Note:** Two hex-wrenches are needed to loosen it.

Loosen the clamping jaw by turning hex-wrench 1 anticlockwise while turning hex wrench 2 in a clockwise direction.



3. Push the cassette together with the adjusting wedge forward towards the tool.



4. Remove the insert from the cassette.

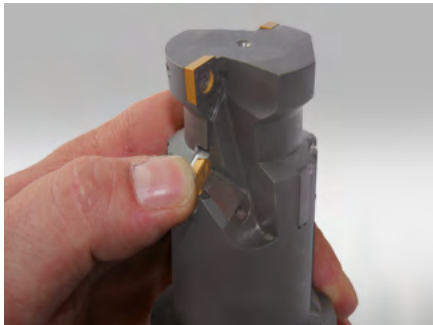
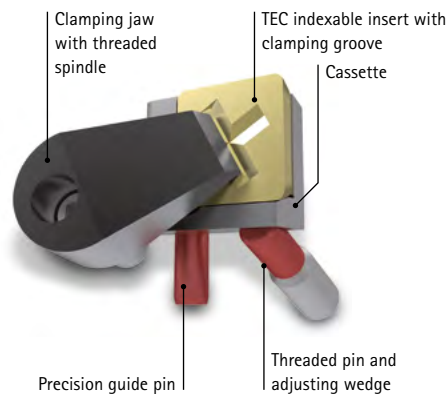
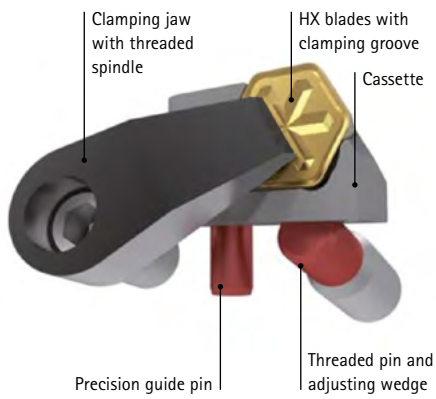

5. Replace or rotate the insert. Then fit the insert into the cassette.

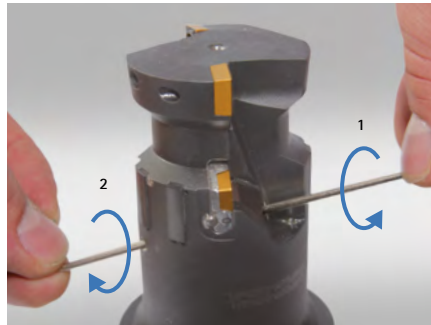

6. **Note:** Two hex-wrench are needed to tighten it.

Tighten the clamping jaw by turning hex-wrench 1 in a clockwise direction while turning hex wrench 2 in an anticlockwise direction.

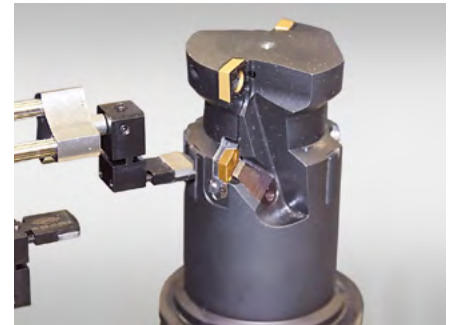

7. **Note:** You can now proceed with either the protrusion measurement or the absolute measurement.

Clamp the tool in the connection of a setting fixture. Move the measuring sensor to the highest point of the guide pad and zero the measured value at this point.

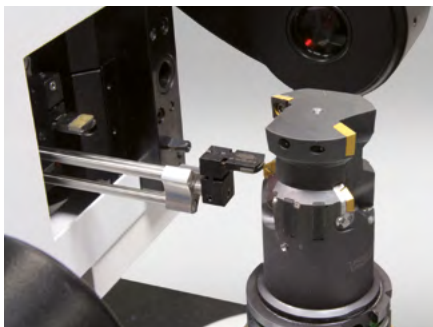

8. Move the measuring sensor to the highest point of the insert.



9. Set the protrusion dimension or absolute dimension of the insert by turning the threaded pin in a clockwise direction using a hex-wrench.

Result:

The desired protrusion or absolute dimension of the insert is set.



Installation and setting instructions for external reamer with the EA system



Replacing the insert

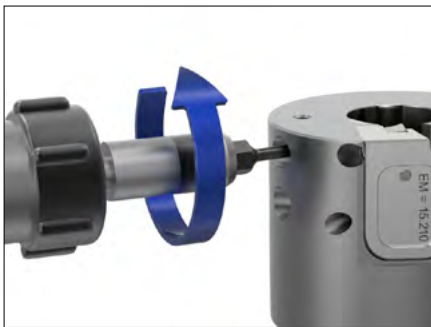

1. Turn both TORX fastening screws anticlockwise and remove the cassette.



2. The insert must be reset to the basic setting: Turn back the adjusting screw half a turn anticlockwise.



3. Turn threaded spindle 1.5 turns anticlockwise.



4. Remove the TEC indexable insert. Clean the insert seat and TEC indexable insert.

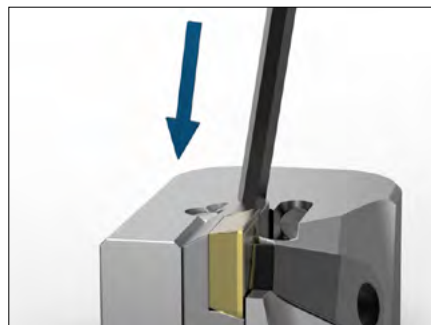

5. Fit the new or rotated insert in the insert seat, paying attention to the axial and radial pressure. Press the insert cassette back slightly against the adjustment direction.

- The insert has now been reset to the basic setting.

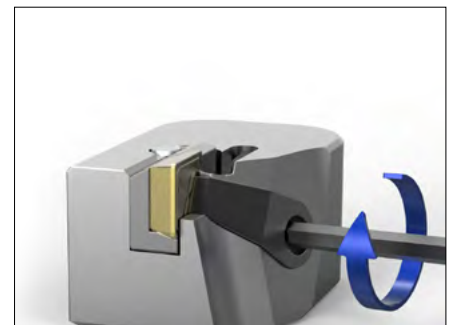

6. Hand tighten the threaded spindle of the clamping jaw clockwise.

Adjusting the insert



7. Adjust the gauge block according to the marking on the cassette and set the feeler to zero.

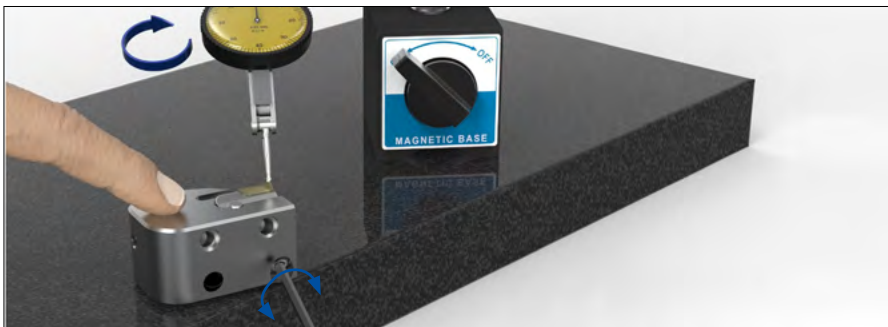

8. Place the feeler onto the highest point of the TEC indexable insert.
Turn the adjusting screw clockwise until the pointer of the dial gauge shows zero.

Assembly



9. Insert the cassette into the cassette seat. Lightly tighten both TORX fastening screws. Then tighten the TORX fastening screws to 2.8 Nm.

Troubleshooting for fine boring tool and fixed reamer

Bore out of round – random / systematic

Causes		Solution
Fine boring tool	Multi-bladed reamer	
Protrusion set too large	-	Check tool setting / set
-	f_z too small / v_c too large	Adjust cutting data (for recommendation see catalogue)
Advance too large	-	Check advance



Bore out of round – random / systematic

Causes		Solution
Fine boring tool	Multi-bladed reamer	
Part clamped (polygon typical jaw chuck)	-	Clamping setup / check clamping pressure
Part with asymmetrical cross sections	-	Reduce cutting pressure (back taper larger, number of teeth smaller, lead steeper, feed smaller)



Bore too large

Causes		Solution
Fine boring tool	Multi-bladed reamer	
Radial run-out error too large	-	Check radial run-out / use alignment adapter
Bad positioning	-	Check the position of the bore
Built-up edge	-	Increase v_c , check cooling lubricant / check suitability of cutting material / check suitability of lead (see catalogue for recommendation)
Vibrations / rattling	-	Adjust cutting parameter / stock removal (see catalogue for recommendation)
Protrusion too large	-	Check / correct setting diameter
-	Tool diameter not correct	Check diameter

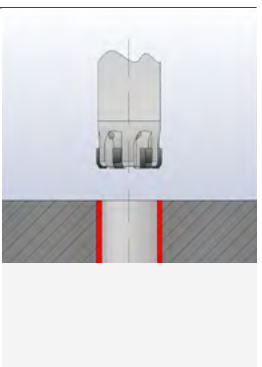

Bore too small

Causes		Solution
Fine boring tool	Multi-bladed reamer	
Cutting edge / cutting edges worn	-	Replace / regrind
Check cutting depth a_p (pre-machining)	-	Adjust cutting depth, see catalogue for recommendation
Thin-walled part (elastic deformation of the part)	-	Reduce cutting forces (back taper larger, number of teeth smaller, lead steeper, feed smaller)
Protrusion too small	-	Check setting / reset

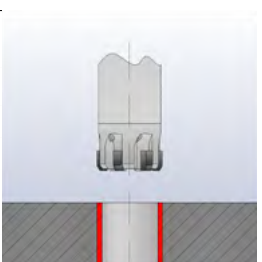

Conical bore entrance | Conical bore exit

Causes		Solution
Fine boring tool	Multi-bladed reamer	
Radial run-out error too large	-	Check radial run-out / use alignment adapter
Positioning problem / axle misalignment	-	Check position of pre-machining or straightness of axle
-	Overrun amount too large	Max. lead length + 1 mm overrun on bore outlet
Advance too large	-	Check advance
Coolant pressure too great	-	Reduce coolant pressure

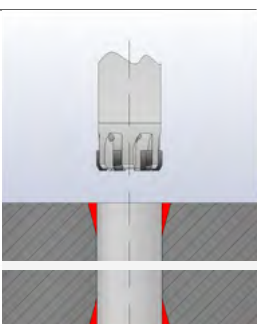

Bore surface not correct – irregularly

Causes		Solution	
Fine boring tool	Multi-bladed reamer		
Structure / macroscopic flaws		Check, replace tool/cutting edges, if necessary; see catalogue recommendation for cutting values	
Stock removal too low		Check pre-machining und stock removal	
Insufficient lubrication/cooling		Check coolant/MQL supply and oil content. Check the suitability of the coolant/additives for this machining operation	
Chip removal disrupted		Increase coolant pressure / adjust cutting edge geometry	
Wear and tear		Replace cutting edge / tool	
Imbalance		Check the connection / adapter and tool for sufficient balancing	

Bore surface not correct – regularly

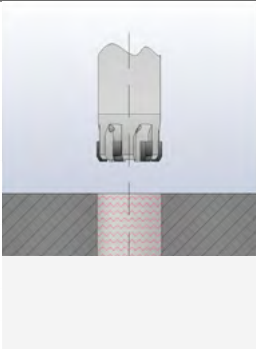
Causes		Solution	
Fine boring tool	Multi-bladed reamer		
Axis misalignment / wrong positioning		Check bore offset and position	
f_z too small / v_c too large		Adjust cut value, (see catalogue for recommendation)	
Critical diameter/length ratio		Check critical diameter/length ratio	
Influences of spindle and drive unit		Change cutting parameters	
Imbalance		Is the combination of connection/adapter and tool sufficiently balanced?	
Back taper too small		Check/set	
Protrusion too large		Check/set	

Bore pattern / cylindrical form not correct

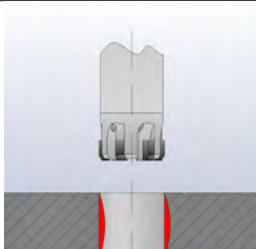
Causes		Solution	
Fine boring tool	Multi-bladed reamer		
Pre-machining incorrect		Consultation with specialist department / product specialist	
Lead geometry and/or tool unsuitable		Consultation with specialist department / product specialist	
Machining strategy unsuitable		Consultation with specialist department / product specialist	

Lead breaks off completely

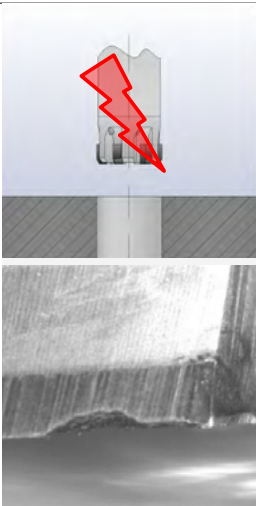
Causes		Solution	
Fine boring tool	Multi-bladed reamer		
Chip removal		Increase coolant pressure / cutting edge geometry	
Back taper too large/small		Check/set	
Stock removal ap too big		Check/adjust	
Wear and tear too high		Replace cutting edge / tool	
Vibrations		Determine cause and stop	
Cutting values not correct		Adjust cut value, (see catalogue for recommendation)	
Advance too large		Reduce advance if necessary	

General machining formulae, boring

Speed and feed

Spindle speed	$n = \left[\frac{1}{\text{min}} \right]$	$n = \frac{v_c \cdot 1000}{\pi \cdot D_c}$
Cutting speed	$v_c = \left[\frac{\text{m}}{\text{min}} \right]$	$v_c = \frac{\pi \cdot D_c \cdot n}{1000}$
Feed rate	$v_f = \left[\frac{\text{mm}}{\text{min}} \right]$	$v_f = f_z \cdot z \cdot n$
Feed/tooth	$f_z = [\text{mm}]$	$f_z = \frac{v_f}{z \cdot n}$
Feed	$f = [\text{mm}]$	$f = f_z \cdot z$
Number of blades	z	

Cutting force

Cutting force F_c	$F_c = A \cdot k_c = b \cdot h \cdot k_c$	F_c in N k_c in N/mm ²
Specific cutting force	$k_c = \left[\frac{k_c \cdot 1.1}{h \cdot mc} \right]$	

Cutting parameters during boring

Along with the specific cutting force for the workpiece material, the cutting cross section A essentially defines the machining force. The feed element per cutting edge f_z and cutting depth a_p are key parameters here.

The following relationships apply:

Feed	$f = [\text{mm}]$	$f = f_z \cdot z$
Setting angle	$\kappa = [^\circ]$	$\kappa = \frac{\sigma}{2}$
Cutting width	$b = [\text{mm}]$	$b = \frac{a_p}{\sin \kappa}$
Chipping thickness	$h = [\text{mm}]$	$h = f_z \cdot \sin \kappa$
Cutting depth	$a_p = [\text{mm}]$	$a_p = \frac{(D - d)}{2}$

The figure shows the cutting cross section A during boring.

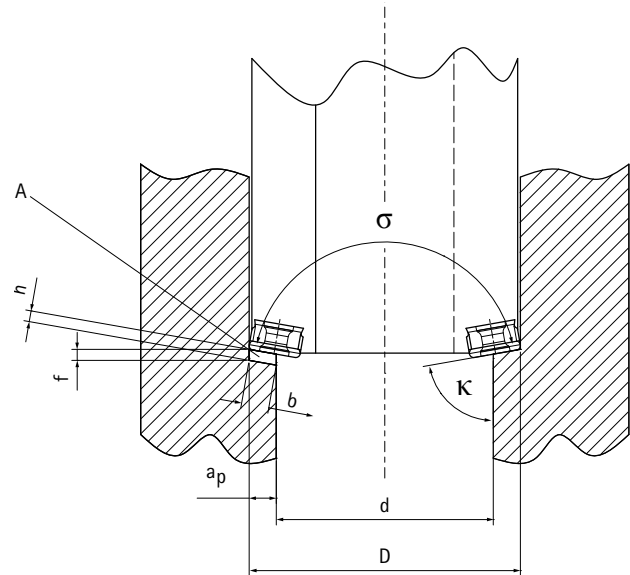

Cutting cross section for boring	$A = [\text{mm}^2]$	$A = \frac{(D - d) \cdot f_z}{2}$	or	$A = a_p \cdot f_z$
----------------------------------	---------------------	-----------------------------------	----	---------------------

Calculation of cutting forces, boring

Simplified

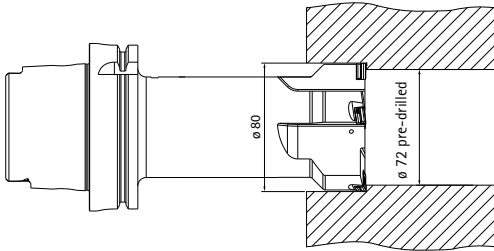

Example calculation:

Boring tool ø 80 mm;
Z = 5; pre-drilled ø 72 mm $\kappa = 90^\circ$

Workpiece material: EN-GJL-250
 $k_{c1.1}^* = 1160$, $M_c = 0.26$
 $v_c = 200$ m/min, $f_z = 0.2$ mm
Blunting 30%

	Basic formula	Calculation	Result
1. Spindle speed	$n = \frac{V_c \cdot 1000}{\pi \cdot D}$	$n = \frac{200 \cdot 1000}{\pi \cdot 80}$	$n = 800$ 1/min
2. Cutting depth	$a_p = \frac{(D - d)}{2}$	$a_p = \frac{(80 - 72)}{2}$	$a_p = 4$ mm
3. Cutting cross section	$A = a_p \cdot f \cdot z$	$A = 4 \text{ mm} \cdot 0,2 \text{ mm} \cdot 5$	$A = 4$ mm ²
4. Chipping thickness	$h = f_z \cdot \sin \kappa$	$h = 0,2 \text{ mm} \cdot \sin 90^\circ$	$h = 0,2$ mm
5. Specific cutting force without blunting factor	$k_c = \frac{k_{c1.1}}{h^{m_c}}$	$k_c = \frac{1160}{0,2^{0,26}}$	$k_c = 1763$ N/mm ² with 30% blunting: $1763 \text{ N/mm}^2 \times 1.3 = 2292 \text{ N/mm}^2$
6. Cutting force	$F_c = A \cdot k_c = b \cdot h \cdot k_c$	$F_c = 4 \text{ mm}^2 \cdot 2292 \text{ N/mm}^2$	$F_c = 9,17$ kN
7. Cutting torque d_m = average diameter in metres	$M_c = F_c \cdot \frac{d_m}{2}$	$M_c = 9167,3 \text{ N} \cdot \frac{0,076 \text{ m}}{2}$	$M_c = 348,3$ Nm
8. Cutting power	$P_c = \frac{2 \cdot \pi \cdot n \cdot M_c}{60s}$	$P_c = \frac{2 \cdot \pi \cdot 800 \text{ min}^{-1} \cdot 348,3 \text{ Nm}}{60s}$	$P_c = 29,2$ kW

* Value for cutting force calculation, WTO GmbH

Note: The efficiency of the main spindle drive is not taken into account.
Corresponding power calculations can be made by MAPAL.

Machine tool selection

Comparison with torque and output power of the machine tool

Two spindle speed/power diagrams follow.

The number of teeth and cutting parameters are to be defined as a function of the machine.

In the example calculation the machine with the motor spindle is unsuitable, as here at a spindle speed of 800 min^{-1} only a torque of 187 Nm and a power of approx. 20 kW are achieved (Figure 1).

Solution:
 Reduce number of teeth, reduce cutting speed and feed, divide cut between two tools or select a more powerful machine (e.g. with geared spindle, Figure 2).

Motor spindle (Figure 1)

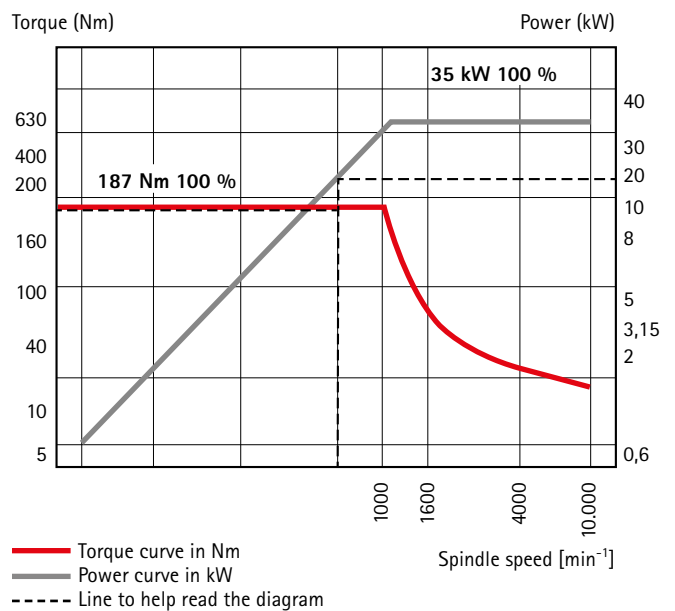

Geared spindle (Figure 2)

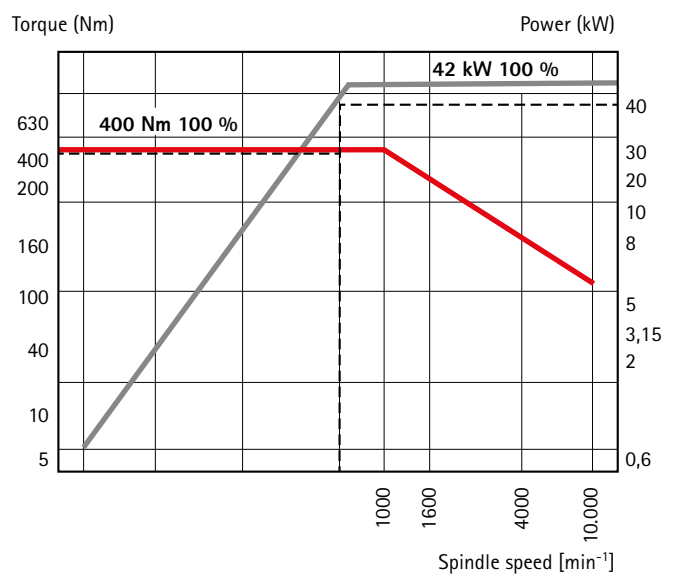



The example diagrams are shown in a simplified form.

Guide values for the minimum boring diameter – radial

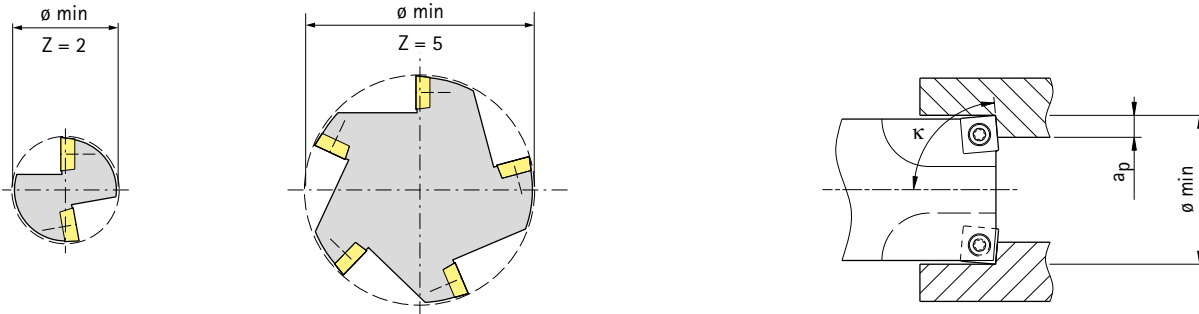
As a function of the number of teeth and indexable insert



Radial boring cutting edges without arc shaped land

Indexable insert form	Size of indexable insert				Number of teeth	Comment
	0603	09T3	1204			
S (90°)	Minimum boring diameter at κ 85°					Suitable for through bore
	17	25	28		1	
	17	25	31		2	
	23	32	39		3	
	31	43	53		4	
	51	63	73		5	
C (80°)	0602	09T3	1204			Suitable for 90° shoulder machining
	Minimum boring diameter at κ 90°					
	17	24	28		1	
	18	26	33		2	
	23	34	41		3	
	31	45	54		4	
49	63	77		5		
T (60°)	06T1	0902	1102	16T3		Suitable in some situations for through bores and 90° shoulder machining
	Minimum boring diameter at κ 90°					
	15	17	17	24	1	
	18	21	24	37	2	
	21	25	28	43	3	
	27	34	37	57	4	
37	51	67	76	5		

Guide values for the minimum boring diameter – tangential

As a function of the number of teeth and indexable insert

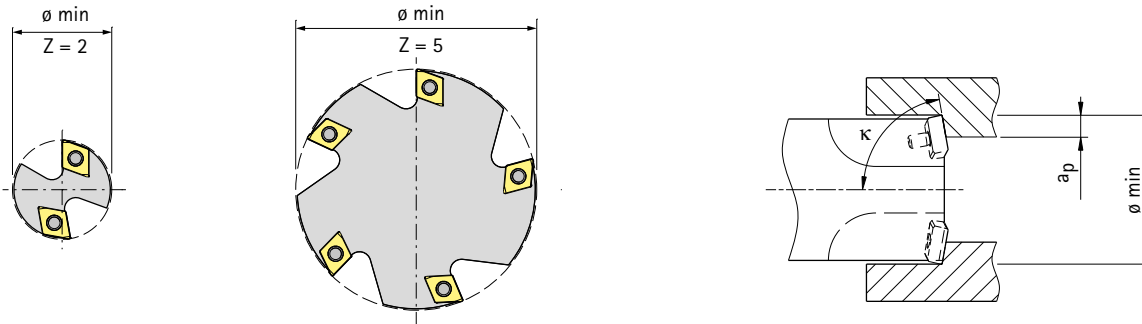

Tangential boring cutting edges without arc shaped land

Indexable insert form	Size of indexable insert			Number of teeth	Comment
	0603/0604	09T3/0905	1204/1206		
C (80°)	Minimum boring diameter at κ 80° and 90°				
	28	41	54	1	Suitable for through bores and 90° shoulder machining
	28	41	54	2	
	30	41	54	3	
	40	56	64	4	
	59	84	94	5	

Tangential boring cutting edges with arc shaped land

Indexable insert form	Size of indexable insert			Number of teeth	Comment
	0604	0905	1206		
C (80°)	Minimum boring diameter at κ 80° and 90°				
	40	65	78	1	Suitable for through bores and 90° shoulder machining
	40	65	78	2	
	40	65	78	3	
	41	65	78	4	
	64	86	102	5	

Tangential boring cutting edges with and without arc shaped land

Indexable insert form	Size of indexable insert			Number of teeth	Comment
	0604	0905	1206		
F (70°)	Minimum boring diameter at κ 80° and 90°				
	22	30	40	1	Suitable for through bores and 90° shoulder machining
	22	30	40	2	
	31	43	53	3	
	42	56	67	4	
	64	83	99	5	

Troubleshooting

Forms of wear on indexable inserts

Form of wear and tear

Clearance surface wear

tangential

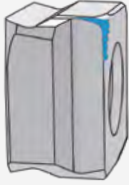

Radial

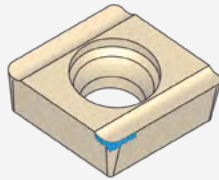

Crater wear

tangential



Radial

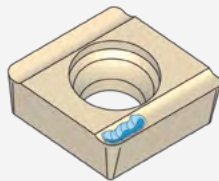

Notch wear

tangential

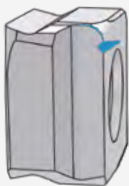

Radial

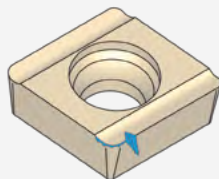

Built-up edge

tangential

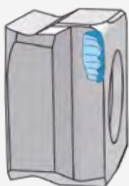

Radial

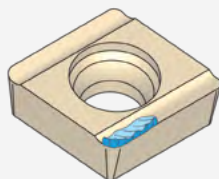

Macroscopic flaws

tangential

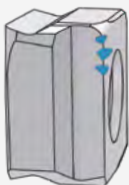

Radial

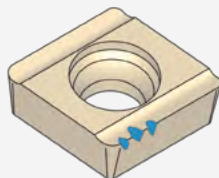

Blade breakage

tangential

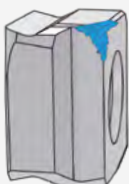

Radial

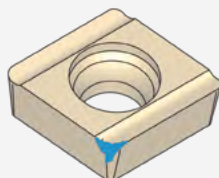

Rectification measures

- Reduce cutting speed
- Select more wear-resistant cutting material type

- Reduce feed
- Reduce cutting speed
- Select more wear-resistant cutting material type
- Use coolant

- Reduce cutting speed
- Select smaller setting angle
- Reduce feed

- Increase cutting speed
- Increase feed
- Select geometry with lighter cut (sharp cutting edges)

- Increase cutting speed
- Reduce feed
- Select tougher carbide grade
- Select stronger geometry
- Improve stability (for example short tool)
- Cooling, continuous or dry (avoid thermal shock)

- Reduce feed
- Reduce cutting depth
- Select stronger indexable insert geometry
- Select tougher carbide grade
- Select thicker indexable insert

Practical application – troubleshooting during boring

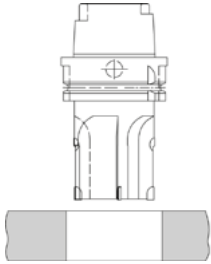
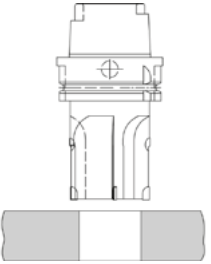
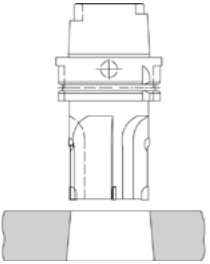
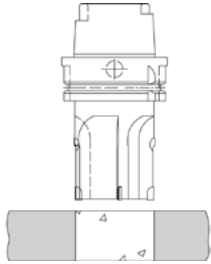
Bore becomes too large	Bore becomes too small	Bore becomes conical	Poor surface finish in the bore
<p>Cause?</p> <ul style="list-style-type: none"> - Tool diameter possibly too large - Cutting speed too high - Feed too high - Radial run-out error too large - Lead uneven - Cooling lubricant unsuitable 	<p>Cause?</p> <ul style="list-style-type: none"> - Tool worn - Cutting speed too low - Feed too low - Workpiece material ductile, pulls together after machining - Stock removal too low 	<p>Cause?</p> <ul style="list-style-type: none"> - Radial run-out error too large - Lead not correct - Pre-machining not correct 	<p>Cause?</p> <ul style="list-style-type: none"> - Cooling lubricant unsuitable - Build up on the cutting edge - Tool blunt, possibly chipping on the cutting edge - Chip removal poor - Residual imbalance too large
			

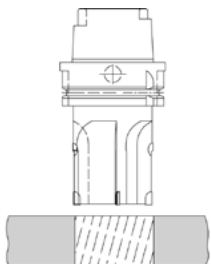
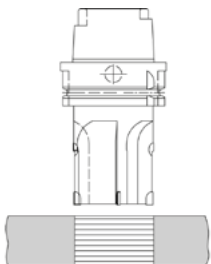
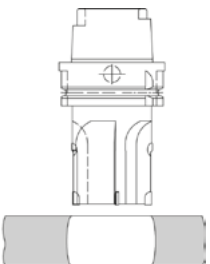
Bore has chatter marks	Bore shows signs of feed scoring	Bore becomes convex
<p>Cause?</p> <ul style="list-style-type: none"> - Build up on the cutting edge - Tool blunt - Cooling lubricant unsuitable - Radial run-out error too large - Residual imbalance too large - Clamping setup not correct 	<p>Cause?</p> <ul style="list-style-type: none"> - Tool blunt, possibly chipping on the cutting edge - Build up on the cutting edge - Cooling lubricant unsuitable 	<p>Cause?</p> <ul style="list-style-type: none"> - Workpiece not clamped correctly
		

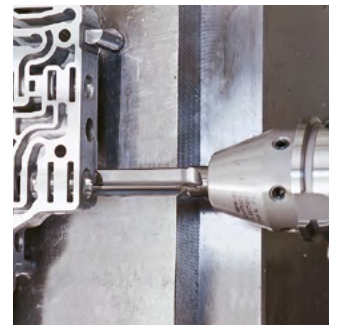

Pictograms

Boring

	Drilling from the solid		Spot drilling		Stepped drilling		Deep drilling
	Drill reaming H7		High-feed machining HFC		High-speed machining HSC		Drilling in packages
	Cross bore		Inclined bore entrance		Inclined bore exit		Flat bottom of the bore 180°
	Tapping bore		Pilot bore		Maximum reachable bore tolerance IT7		Stocked preferred series in H7 H7
	Tolerance tool grinding diameter Grind		Maximum drilling depth 3xD		Internal cooling		Connection CFS
	With indexable insert		Connection QTS		Connection TTS-100		Connection TTS-300
	Shank form HA in accordance with DIN HA DIN 6535		Shank form HB in accordance with DIN HB DIN 6535		Shank form HE in accordance with DIN HE DIN 6535		

Reaming | Fine Boring

	Through bore		Blind bore		HFS axial clamping system		HFS radial clamping system
	Stocked preferred series in H7 H7		Maximum reachable bore tolerance IT7		Tolerance tool grinding diameter Grind		Single-bladed reamer
	WP-blades WP		Internal cooling		Connection HFS		Connection Modul
	Connection Shank hollow shank taper-A HSK-A		Connection with morse taper shank (MK) MK		Shank form HA in accordance with DIN HA DIN 6535		Shank form HE in accordance with DIN HE DIN 6535
	Cylindrical shank with clamping surface						

Countersinking

	Countersink according to DIN DIN 335 C		90° countersinking 90°
--	--	--	----------------------------------

Configuration

	Product with configurable features CONFIG
--	---

Pictograms

Product line



Basic
LINE

Basic Line:
Universal tools, broad field of application,
low procurement costs



Performance
LINE

Performance Line:
High-performance tools, broad field of application,
high productivity in series production manufacturing



Expert
LINE

Expert Line:
Specialist tools for selected applications,
maximum precision and productivity

Material suitability



Highly suitable

Suitable in some situations

E.g. Standard material suitability table

P	1	2	3	4	5	6	M	1	2	3	K	1	2	3	N	1	2	3	4	S	1	2	3	4	5	H	1	2	3
	■	■	■	■								■	■																

E.g. Material suitability table for non-ferrous metal and lightweight materials

N	1.1	1.2	1.3	1.4	2.1	2.2	2.3	3.1	4.1	4.2	4.3	G	1.1	1.2	1.3	2.1	3.1	4.1	4.2	5.1	5.2	5.3				
										■								■								

MAPAL machining groups

Machining group		Workpiece material	Strength/hardness [N/mm ²] [HRC]	Frequently machined workpiece materials
P	P1	P1.1 Structural, free-cutting, case hardened and heat-treated steels, non-alloy	< 700 N/mm ²	1.0122 (S235/St 37), 1.0401 (C15), 1.0503 (C45), 1.0570 (S355/St 52), 1.1213 (Cf53)
		P1.2 Structural, free-cutting, case hardened and heat-treated steels, non-alloy	< 1.200 N/mm ²	1.1249 (Cf70)
	P2	P2.1 Nitrided, case hardened and heat-treated steels, alloy	< 900 N/mm ²	1.7131 (16MnCr5)
		P2.2 Nitrided, case hardened and heat-treated steels, alloy	< 1.400 N/mm ²	1.7227 (42CrMoS4)
	P3	P3.1 Tool, bearing, spring and high-speed steels*	< 800 N/mm ²	1.2343 (X37CrMoV5-1), 1.2762 (75CrMoNiW6-7)
		P3.2 Tool, bearing, spring and high-speed steels*	< 1.000 N/mm ²	1.2367 (X38CrMoV5-3), 1.2713 (55NiCrMoV6)
		P3.3 Tool, bearing, spring and high-speed steels*	< 1.500 N/mm ²	1.2379 (X153CrMoV12) 1.2738 (40CrMnNiMo8-6-4)
	P4	P4.1 Stainless steels, ferritic and martensitic		1.4510 (X3CrTi17), 1.4589 (X5CrNiMoTi15-2)
P5	P5.1 Cast steel		1.7231 (G42CrMo4)	
P6	P6.1 Stainless cast steel, ferritic and martensitic			
M	M1	M1.1 Stainless steels, austenitic	< 700 N/mm ²	1.4301 (V2A), 1.4571 (V4A)
		M1.2 Stainless steels, ferritic/austenitic (duplex)	< 1.000 N/mm ²	1.4362 (Alloy 2304), 1.4501, 1.4662 (LDX 2404)
	M2	M2.1 Stainless/heat-resistant cast steel, austenitic	< 700 N/mm ²	
	M3	M3.1 Stainless cast steel, ferritic/austenitic (duplex)	< 1.000 N/mm ²	
K	K1	K1.1 Cast iron with lamellar graphite (grey cast iron), GJL	< 300 N/mm ²	GJL-250 (GG-25), GJL-260 (GG-26 Cr)
		K2.1 Cast iron with spheroidal graphite, GJS	< 500 N/mm ²	GJS-400 (GGG-40), GJS-450 (GGG-45)
	K2	K2.2 Cast iron with spheroidal graphite, GJS	≤ 800 N/mm ²	GJS-600 (GGG-60), GJS-800-2 (GGG-80), GJS-800-8 (ADI 800)
		K2.3 Cast iron with spheroidal graphite, GJS	> 800 N/mm ²	GJS-900-2 (GGG-90), GJS-1000-5 (ADI 1000), GJS-1200-2 (ADI 1200), GJS-1400-1 (ADI 1400)
	K3	K3.1 Cast iron with spheroidal graphite, GJV; malleable cast iron, GJM	< 500 N/mm ²	GJV-300, GJV-400, GJMW-400-5 (GTW-40)
		K3.2 Cast iron with spheroidal graphite, GJV; malleable cast iron, GJM	> 500 N/mm ²	GJV-500, GJV-700
N	N1	N1.1 Aluminium, non-alloy and alloy < 3 % Si		Alloy 2024, Alloy 7075, Al99
		N1.2 Aluminium, alloy ≤ 7 % Si		AlSi7
		N1.3 Aluminium, alloy > 7-12 % Si		AlSi9, AlSi9Cu
		N1.4 Aluminium, alloy > 12 % Si		AlSi12, AlSi17
	N2	N2.1 Copper, non-alloy and low-alloy	< 300 N/mm ²	SE-Cu
		N2.2 Copper, alloy	> 300 N/mm ²	CuSn6
		N2.3 Brass, bronze, gunmetal	< 1.200 N/mm ²	CuZn33, CuAl9Mn3
	N3	N3.1 Graphite, > 8 µm		
		N3.2 Graphite, ≤ 8 µm		
	N4	N4.1 Plastic, thermoplastics		PA, PE, PC, PS, PVC, PP, PTFE, POM, PMMA
		N4.2 Plastic, thermosets		PU, PF, EP, UP, VE, CR
		N4.3 Plastic, foams		EPS, PUR, PVC-E, PS-E, PP-E
	C	C1	C1.1 Plastic matrix, aramide fibre-reinforced (AFRP)	
C1.2 Plastic matrix (thermosetting), CFRP/GFRP				IMS, HTA
C1.3 Plastic matrix (thermoplastic), CFRP/GFRP				GMT-PP, PEEK
C2		C2.1 Carbon matrix, carbon fibre-reinforced (CFC)		CF222, CF225, CF226, CF227, CF260
C3		C3.1 Metal matrix (MMC)		CeramTec AO-403 (AlSi9MgMn-Al2O3), Al/Cu/Mg-SiO2/Al2O3/AlN/TiC/SiC/BN/TiB2
		C4.1 Sandwich construction, honeycomb core		
C4.2 Sandwich construction, foam core			PLASCORE PAMG-XR1 5052, PCGA-XR1 3003, PAMG-XR1 5056, Micro-Cell (core made of alloy 5052/5056)	
C5		C5.1 Composite (stack), non-metal - non-ferrous metal composite		CFK-aluminium, IMS/HTA + Alloy 2024/6061/7075
		C5.2 Composite (stack), non-metal - metal composite		CFK-titanium, IMS/HTA + TiAl6V4/AMS4905
		C5.3 Composite (stack), non-metal - non-metallic composite		CFK-CFK
		C5.4 Composite (stack), non-ferrous metal - non-ferrous metal composite		Aluminium-aluminium
		C5.5 Composite (stack), non-ferrous metal - metal composite		Aluminium-titanium
	C5.6 Composite (stack), metal - metal composite		Titanium Inox	
S	S1	S1.1 Titanium, titanium alloys	< 400 N/mm ²	
		S2.1 Titanium, titanium alloys	< 1.200 N/mm ²	TiAl6V4
	S2	S2.2 Titanium, titanium alloys	> 1.200 N/mm ²	
		S3.1 Nickel, non-alloy and alloy	< 900 N/mm ²	1.3912 (Invar, Ni36)
	S3	S3.2 Nickel, non-alloy and alloy	> 900 N/mm ²	
		S4.1 High-temperature super alloy Ni, Co and Fe-based		Hardox, Hastelloy, Incoloy, Inconel, NIMONIC, Stellite, Waspaloy
S5	S5.1 Tungsten and molybdenum alloys			
H	H1	H1.1 Hardened steel / cast steel	< 44 HRC	1.2738 HH, 1.2085, Toolox 33, Toolox 44
		H1.2 Hardened steel / cast steel	< 55 HRC	1.2343, 1.2311, 1.2312, 1.2714, 1.2083, 1.2738
	H2	H2.1 Hardened steel / cast steel	< 60 HRC	1.1730, 1.2379, 1.2358, 1.2767, 1.4112, ASP 2012
		H2.2 Hardened steel / cast steel	< 65 HRC	1.2379, 1.2363, 1.2436, 1.2842, ASP 2005, Vanadis 23
	H2	H2.3 Hardened steel / cast steel	< 68 HRC	ASP 2017, ASP 2023, Vanadis 30, Vanadis 60
		H3.1 Wear-resistant cast/chill casting, GJN		

* If the alloy parts Cr, Mo, Ni, V, W in total > 8 % then select the next highest MAPAL machining group.



Discover tool and service solutions now that give you a lead:

BORE MACHINING

REAMING | FINE BORING

DRILLING FROM THE SOLID | BORING | COUNTERSINKING

MILLING

CLAMPING

TURNING

ACTUATING

SETTING | MEASURING | DISPENSING

SERVICES

FOLLOW US

